



CORNELL
UNIVERSITY
LIBRARY

CORNELL
UNIVERSITY
LIBRARY



GIFT OF

Professor

Frank H. Golay

INDEX

Pages

Commercial Fishes of the Philippines-----	513-520
Sponge Fisheries of the Philippines-----	57-64
Pearls & pearl Fisheries of the Philippines	87-102
Miscellaneous Marine Products of the Philippines -----	283
Trepang -----	283-289
The Shark-fin Industry -----	289-291
Philippine Sea Turtles and Tortoise Shell -	291-295
Philippine Window Shell -----	296-300
Philippine Shells used in the Manufacturing of Buttons -----	300-305
Precious Corals -----	305
Edible Seaweeds of the Philippines -----	308-309
Preparations of Isinglass in the Philippines -----	309-310
Preparing Skins of Aquatic Animals for Leather -----	310-312
Check list of Philippine Holothurians -----	313-317
Notes on Philippine Edible Mollusks -----	273-280
The Successful Transference of Black Bass to the Philippine Islands, with notes on the Transporting of live fish long distances -----	153-158
Some Poisonous Philippine Fishes -----	289
Description of four new species of fishes from Bantayan Is. -----	115
Fishes of Borneo, with descriptions of four new species -----	263
New species of Philippine fishes -----	491
Fishes of the Philippine Islands -----	51
Description of <i>Acanthocybium forbesi</i> -----	283

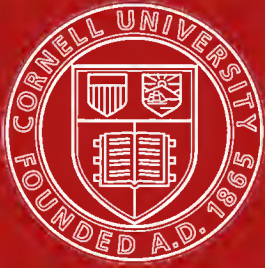

Cornell University Library

The original of this book is in
the Cornell University Library.

There are no known copyright restrictions in
the United States on the use of the text.

THE FISHERY RESOURCES OF THE PHILIPPINE ISLANDS. PART I, COMMERCIAL FISHES.

By ALVIN SEALE.

(From the Bureau of Science, Manila, P. I.)

INTRODUCTION.

We have received numerous requests for information regarding the commercial fisheries of the Philippine Islands, especially relating to the different kinds of edible fish and their abundance; the location of fishing banks and the methods of capture. We have also been asked if fishing, entered into as a commercial venture, would be profitable.

It is for the purpose of answering some of these questions that Part I of this series, based on my personal observation in the various islands of the group during the past year and a half, has been prepared. It is hoped that this paper, together with others to follow—namely, Part II, Sponge Fisheries; Part III, Pearl Fisheries; Part IV, Other Marine Products (aside from fishes, pearl oysters, and sponges)—will serve to create an interest and help in the development of the rich fishery assets of the Islands.

THE ANCHOVIES.

Family *Engraulidae*. (Pl. I.)

There are at least four different species of anchovies in the Philippine waters, the most abundant, perhaps, being *Anchovia commersoniana* (Lacépède), called *dilis* in Tagalog, *monamon* in Ilokano, and *anakbat* in Moro. *Anchovia dussumieri* Bleeker, termed *dumpilas* in Tagalog, and *teggui* in Moro is a large species, but less abundant than the *dilis*.

The common anchovy (*dilis*) is found in great numbers along the shores of almost all the islands of the group; it is almost transparent, with very thin, deciduous scales. This species is a delicate little fish of fine flavor and would bring a good price, if put up in attractive form either in oil or spice, or if made into anchovy paste.

THE HERRINGS.

Family *Clupeida*. (Pl. II.)

There are about thirteen distinct species of herring represented in the Philippine waters and notwithstanding their rather small size, they are of considerable commercial importance. They abound in immense numbers along the coasts of almost all the islands of the group. Some are more or less migratory, others seem to remain near one place. Large numbers are caught in Manila Bay at all seasons of the year. These represent the forms called *tunsoy* [*Harengula moluccensis* (Bleeker)], *tamban* (*H. longiceps* Bleeker), and *bilis* [*H. gibbosa* (Bleeker)]. The young of all species are termed *siliñasi*. Great numbers are caught in corrals, especially during May and June; they are also taken in the drag-seine. It is not an unusual sight to see large *bancas* loaded to the gunwale with herring being landed at Tondo beach, where the fish are sold to the Chinese to be smoked and dried. The natives in Zamboanga buy large quantities to eat in the fresh state. Any of these sardines would compare favorably with the species put up in oil on the Pacific coast.

During the nine months from January first to September first, 1907, 85,000 pesos worth of canned sardines were imported into the Philippines; this, too, with the Philippine waters swarming with sardines and with an abundance of good sesame oil which could be used for canning purposes, produced in Manila.

THE SILVERSIDES.

Family *Atherinida*. (Pl. III.)

The silverside, called *guno* in Tagalog and Moro, and *ti-i* in Ilokano, is without doubt the most abundant fish in the Philippines. It is almost impossible to land at any wharf or go ashore on any beach without seeing these little fish in countless numbers. They usually grow to a length of from 10 to 12 centimeters. They have a greenish tint on the back and a bright, silvery band on the sides. There are five or six different species, but they appear so much alike that the natives have not distinguished between them, calling all simply *guno*. The most common species is possibly *Atherina temminckii* (Bleeker).

The *guno* are known as *pescados del rey*, "fishes of the king," among the Spaniards. They are greatly valued as food. The young are termed whitebait. The method of catching is usually by seine or corral. A profitable industry could be built up by preparing these fish in a good sauce, by pickling them with spices, or by drying. An abundant supply

for canning operations could be secured at any of the following places: Manila, Jolo, Zamboanga, Sitanki, Puerto Princesa, and perhaps a dozen other places not yet examined. They abound at all seasons.

THE MACKERELS.

Family *Scombrida*. (Pl. IV.)

There are at least eight different species of the mackerel family found in the Philippines, all of them good food fishes and of commercial importance. In this family is the *tanguingue*, also called *tangili* or *tungi* (Moro), which is a true Spanish mackerel (*Scomberomorus commersoni* Lacépède). By many people this is regarded as the finest food fish in the Philippine waters. This fish is fairly abundant, and can usually be found in the markets, where it sells from 1 to 4 pesos, Philippine currency (50 cents to 2 dollars United States currency) per fish. At Zamboanga it is nothing unusual to see ten or a dozen of these fish in the market at one time, all of them measuring 90 centimeters or more in length. They are frequently cut up and sold by slices. The major part of the *tanguingue* are caught off shore with a hook and line, a good fishing ground being located off the east coast of Basilan. At Manila they are usually caught in nets. Another Spanish mackerel taken in these waters is *Scomberomorus konam* (Bleeker), which is scarcely distinguishable from the above.

Other important members of the family are the chub mackerels (*alumahan* or *carallas*), *Scomber microlepidotus* Rüppell, and the *hasa-hasa* (*Scomber japonicus* Houttuyn). These fish run in great shoals throughout the Islands, following small fish, upon which they feed. They enter Manila Bay in March and the inhabitants along the shore-line of the bay are kept awake during the nights by the noisy clatter of the fishermen beating with their paddles against the sides of their boats in order to frighten these much desired fish into the nets or hastily constructed corrals.

Still other members of this family represented in these waters are the small bonitoes (*sobad* or *tulinŷan*) *Gymnosarda pelamis* (Linn.), the great tunnies (also called *sobad*), and the albacore (*Germa alalunga* Bleeker).

All of these fish may be caught with hook and line, in nets or corrals. They are so abundant that it is unusual to make a trip among the Islands without sighting one or more shoals of fish belonging to this family. They are especially common about the Cuyo group and along the shores of Palawan. The market at Zamboanga is usually well stocked with all members of the family. They are with few exceptions fishes of the deep water. The purse-seine in my opinion could be profitably employed in their capture.

THE MUD FISHES.

Family *Ophioccephalida*. (Pl. V.)

The mud fishes, *dalag* (*dalak* in Moro), are of considerable importance, especially in the vicinity of Manila where they form a large part of the food of the native population. They are usually sold alive in the markets. In fact, it is their ability to stay alive out of water that attracts attention to them. They are primarily a fresh- or brackish-water fish, and after a rain almost all the little pools by the wayside, as well as the paddies and rivers are well filled with *dalag*. They have the habit of burying themselves in the mud as the ponds dry up and thus of lying dormant until the next rain. They take the hook freely, and it is no uncommon sight to see the natives fishing for them in the rice-fields, or in the most unlikely and recently formed pools. They frequently travel overland in the wet grass and can live for hours out of water. The eggs are deposited in holes in the bank; the mother exercises a care over the young fish.

In India these are regarded as one of the most wholesome fishes and are given to invalids. In Manila they are looked upon more as scavengers and are not much eaten by the Americans. These mud fish are distinctly carnivorous, feeding on small fish, refuse, etc. They are well distributed over the Islands, being found in almost all the lakes and rivers.

THE SNAPPERS.

Family *Lutianida*. (Pl. VI.)

There are about twenty different species of this family in the Philippine waters, all of them important as food fishes. They range when full grown from 25 to 90 centimeters in length. They are distributed over the entire group, some running up rivers to the interior lakes to feed. Several of the species are bright red in color and are called red snappers, one of the most abundant being the *bachuan* [*Lutianus doleacanthus* (Bleeker)]. Another snapper called the *camangbuhu* (*Lutianus fuscescens* Cuv. et Val.) can usually be found in the markets, especially in Zamboanga. A very important member of the family is the *aleis* (*katumbang* in Moro) (*Lutianus gembra* Bloch et Schn.). These are caught in great numbers in the Naujan River at Batos, Mindoro. The adults weigh from 8 to 20 pounds each. I saw 108 of these fish caught in one-half day at the Batos corral.

The best banks for red snapper fishing seem to be in the vicinity of Zamboanga. *Dapa* and *managal* are other Moro names applied to the red snapper. They are usually caught by hook and line, or in the corral. In Zamboanga a red snapper 35 centimeters long can be bought for 40 centavos.

THE POMPANOS.

Family *Carangida*. (Pl. VII.)

There are thirty-six different species of the pompano family known in the Philippines. All of them are valuable commercial fishes. The cavallas (*Caranx*) are the most important branch of the family. They are termed *talakitok* in Tagalog and *daingputi* in Moro. These fish are very abundant in almost all markets. They range from 32 to 36 centimeters in length. As a rule they are caught in corrals.

Another abundant species is the *lison* [*Caranx ignobilis* (Forskål)]. These fish are dried in large numbers by the Moros. The *ballangoan*, termed *cubal-cubal* (*Megalaspis cordyla* Linn.), is another very abundant food fish of fine flavor, belonging to this family. These are reported to reach the length of 155 centimeters; ordinarily those in the market measure about 45 centimeters. They are caught in corrals.

THE SEA BASSES.

Family *Serranida*. (Pl. VIII.)

There are thirty-three species of this important family of food fish reported from the Philippines. One of the most familiar is the *apahap* (*tapog* in Moro) [*Lates calcarifer* (Bloch)], one of our largest sea basses. Specimens weighing from 25 to 35 kilos are frequently brought into the market. This fish would afford good sport for local anglers. The largest branch of the family is constituted by the groupers (*Epinephelus*), called *lapo-lapo* in Tagalog, *garopa* in Visayan, and *kukkut* in Moro. (Pl. VIII.) Ordinarily this name is given to the most common species, *Epinephelus merra* Bloch, but it is also applied to at least three others which closely resemble *E. merra*. These fish bring a high price in the Manila market; they are a favorite sea food for many Americans.

Another rather common species is the blue-spotted grouper [*Cephalopholis stigmatopomus* (Richardson)], which is especially abundant in the Zamboanga market. The fishes of this family are usually caught with hook and line in water of considerable depth; sometimes they are taken by net or corral. Gill-nets set in about 50 feet of water frequently make good catches.

THE MULLETS.

Family *Mugilida*. (Pl. IX.)

There are ten different species of mullet recorded from the Philippines, the most abundant being the *banak* (*Mugil cephalus* Linn.). This fish can always be found in the market and when quite fresh and properly cooked is most delicious. It is very common throughout the entire Archipelago. The mullet is a strictly vegetable feeder, and is usually

found wherever there is an abundance of sea moss. The shallow sea about the Island of Sitanki is a famous feeding ground for this fish.

On the morning of June 29 of this year I witnessed a most astonishing movement of mullet near the Island of Sitanki, Sulu Archipelago. A noise like a great waterfall was heard. Hastening to the beach I saw a vast shoal of the fish coming from the north, keeping quite near the shore; they were leaping along the water in great, flashing waves. The shoal was fully 100 yards wide and 500 yards long; there must have been over a million individuals in it. The fish seemed to be of almost uniform size, about 40 centimeters in length. Nothing stopped them. The natives jumped into the water and killed hundreds with sticks and stones; some were driven ashore, but the shoal passed, leaping, on to the south.

These fish were probably seeking a new feeding ground. They were not breeding, this fact being indicated by the extreme smallness of the ovaries. I should estimate that there were over one hundred thousand pesos' worth of fish in this one lot.

Several species of this family run up the fresh water rivers to the lakes. As many as ten thousand have been caught at one time with a drag-seine near the mouth of the Naujan River in Mindoro. These fish are easily dried and are a good commercial asset.

OTHER COMMERCIAL FISHES.

There are many other fishes in the Islands that are of commercial importance, but lack of space and time will not permit of a detailed description. However, among these we should mention the barracuda, called *pangaloan* or *lumbanak* in Moro. This is an abundant and excellent food fish sometimes reaching the length of 1.5 meters. There are also numerous species of porgies, termed *bitilla*, *cutcut*, and *guntul* by the natives. These fish are especially abundant about Sitanki, and there they are dried in large numbers. Many members of the grunt family (*Hæmulidæ*) are also seen, these are termed *leffe*, *pasinco*, *bakuku*, and *bagong*;¹ they are especially valuable for salting and drying.

Several members of the gar family (*Belonidæ*), the croakers (*Sciaenidæ*), the parrot-fishes (*Scaridæ*), the surmulletts (*Mullidæ*), the mogarras (*Gerridæ*) and the soldier-fishes (*Holocentridæ*) occur. All of these are good food fishes and of commercial importance. A provisional, but incomplete list of the Philippine market-fishes, giving the native, scientific, and English names will be found at the end of this article.

¹ *Bagong* is a general term applied to any small fish mixed with salt and partly dried. *Bagong* is most commonly eaten in the interior where fresh fish can not be obtained.

THE MILKFISHES.

Family *Chanidae*. (Pl. X.)

The *awa* or milkfish [*Chanos chanos* (Forskäl)], called *bañgos*, *bañgod*, *kawag-kawag*, and *tumulocso* by the Filipinos and *bangellus* by the Moros, is one of the most important commercial fishes in the Islands. It ranges over the entire group, from northern Luzon to Sitangi and is the most abundant fish in the Manila market. Frequently, during protracted rough weather it is the only variety obtainable. It is raised chiefly in the fish ponds at Malabon and at other places near Manila and therefore can be secured at any time regardless of the weather.

This fish is particularly adapted to pond culture, being a vegetable feeder of rapid growth. The *bañgos* superficially resembles the mullet, but can easily be distinguished by the fact that the mullet has two fins on the back, while the *bañgos* has but one. The *bañgos* frequently reaches a length of 1.2 meters and then it is termed *tumulocso*. The eggs are deposited in the sea. The young appear during the months of April, May, June, and July and are called *kawag-kawag*. They are supplied with a yolk-sack which furnishes them with food until they are about 14 millimeters in length. At this age they are to be found in great numbers along the beaches of Zambales, Batangas, Mindoro, Marinduque, and doubtless in numerous other places. Here they are captured by the natives and placed in large earthen jars full of water called *palyok*. They are then conveyed to the fish ponds, frequently a hundred miles distant. (Fig. 1.)

One of the jars, *palyok*, contains about 2,500 young *bañgos*. They sell for from 20 to 25 pesos per *isang laca* (10,000); about six *laca* (60,000) are used to stock one pond of 1 hektare. As the fish grow they are thinned out by transfer to other ponds. Thirty-three per cent should reach marketable size. Four months after the transfer the *bañgos* should each be 25 centimeters in length. This size of fish retails for 9 centavos each; in 8 months the young are each 40 centimeters long and bring 20 centavos, while a yearling should measure half a meter and bring from 50 to 60 centavos.

FISH PONDS.²

Almost any kind of ground other than a sandy soil will do for a fish pond. It should be near salt water and not beyond the influence of the tide, as the *bañgos* thrive best in brackish water. A complete system should have at least four ponds. These should be so constructed that one equals in area at least that of the other three combined.

² I am indebted to Mr. W. D. Carpenter of Malabon for most of the information regarding fish ponds.

Usually the area of the large pond is much greater. The dikes of the small ponds are low, often not 30 centimeters above the water level. These smaller ponds are of about equal size, being usually rectangular and each of about 200 square meters in area. The *palaistaan* are formed by throwing up dikes. The main dikes are large, especially along the banks of the so-called "river" or estero, where mangrove trees frequently are planted for their protection. The water from the estuary is permitted, when the tide is flowing, to enter one of the smaller ponds through a sluice (*pirinza*) usually constructed of masonry with two gates, one of several slides of solid wood for controlling the water and the other of close bamboo palings to prevent the egress of the *bañgos* and the ingress of undesirable tenants such as carnivorous fishes and crabs which burrow into the dikes and cause leakage. Snakes and birds are also evils that have constantly to be guarded against.

This small pond distributes the water supply to the others and is used for capturing the marketable *bañgos*. It is usually separated from the larger pond by a close paling of bamboo around the narrow opening in the partition dike. When it is desired to capture the fish in the largest pond, the paling is removed and a strong current is caused to flow from the smaller pond to the larger. The *bañgos* attracted by the fresh water swim against the current and enter the smaller pond in great numbers, where they are readily captured in a seine. This operation is often accomplished about midnight, so that the fish will be exposed in the Manila markets in the best condition.

The remaining two ponds, or subdivisions of the pond area inclosed within the limits of the boundary dikes, are connected with each other and with the pond which feeds the water by single pipes made of the hollow log of the *layong* (*Diospyrus nigra* Retz). These tubes are called *palabuñbuñgan*, the water and fish being controlled at these openings by a solid wooden plug or a funnel of bamboo strips. The water in these two small ponds is kept at a depth of but a few decimeters, the ponds being used interchangeably for cultivating the food alga (*Oedogonium*) and for developing the *kawagkawag*. (Fig 2.)

FOOD OF THE BAÑGOS.

If it is desired to cultivate the food alga (the large pond is originally stocked in the same way), the water is allowed to drain off and the clay is exposed to the full power of the sun. The alga rapidly makes its appearance and a little water is then permitted to cover the bottom. This is gradually increased as the *Oedogonium* develops.

The *Oedogonium* seems to thrive best upon a clean clay (kaolin). If the bottom is covered with a deposit of dark mud and in old ponds where a black, evil-smelling deposit has formed, it is scraped clean with

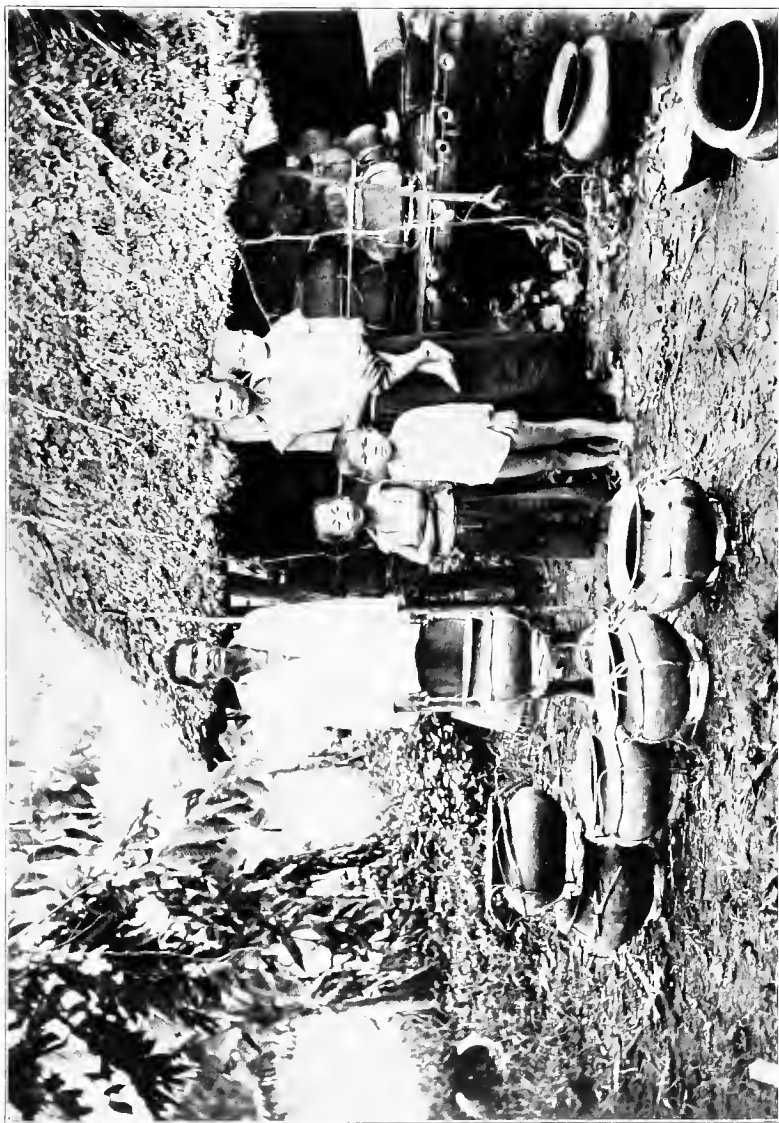

FIG. 1. THE GUARDIAN OF A FISH POND WITH HIS FAMILY, AND THE JARS OR PLYOK IN WHICH THE FRY ARE TRANSPORTED.

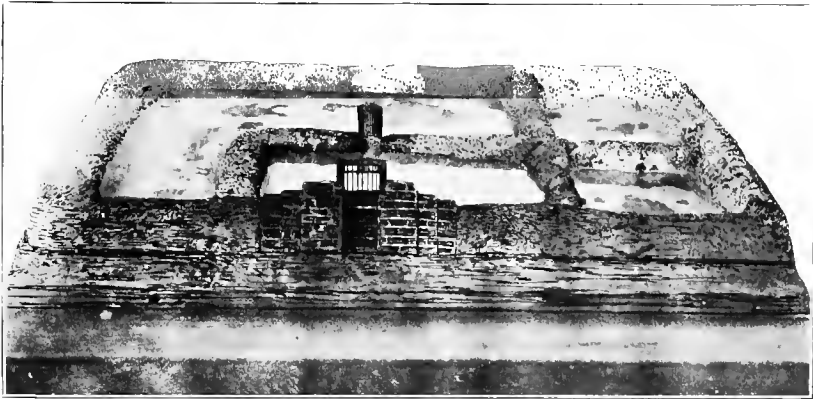

FIG. 2. MODEL OF A BAÑOS POND SYSTEM CONSTRUCTED BY THE STUDENTS OF THE MALABON INTERMEDIATE SCHOOL.

a board. This operation is not necessarily done at any particular season, but whenever the condition demands it. The *Oedogonium* is sometimes purchased and placed in an exhausted pond. A small *bancu* load is worth one peso.

A so-called "medicine" for the young fish (apparently used only in small ponds where the water is contaminated by close proximity to houses) is the *Lemna minor* Linn., the floating roots of which are greedily devoured.

When the fry are to be planted in the pond, the water is again allowed to drain off and the alga is partially killed by the hot sun. This, it is claimed, renders the *Oedogonium* soft and fragile for the tiny mouths. Eventually, the young *ban̄gos* are removed to the great pond where their quantity is largely governed by the supply of the food alga.

The average value of the ponds about Manila Bay is probably 40 centavos per square meter, giving a total of more than 6,000,000 pesos for the pond value alone, which I am convinced is a conservative estimate. I chose one pond which measured 140 by 170 meters as an average of the twenty or more shown on a surveyor's map compiled from data obtained from the owners of the properties.

METHODS OF FISHING.³

It has been my privilege to make personal observations of the methods employed in the fisheries of various parts of the world, in the United States, Alaska, New Zealand, Australia, Honolulu, and numerous Pacific Islands, also to some extent in Japan. Some time ago at the instance of the Secretary of the Interior, Mr. Dean C. Worcester and before I assumed my position in the Bureau of Science, I made a more detailed examination of the methods employed in the fisheries of the eastern United States in order to secure the latest information regarding the various kinds of nets and apparatus that could with profit be used to develop the commercial fisheries of the Philippine Islands.

It may not be out of place, therefore, to give brief descriptions of such apparatus as seems to me to be of especial value and short suggestions as to its use.

SEINES.

In the Atlantic fisheries a great many more fish are caught with the various kinds of seines than in any other way. In 1904, the New York fisheries alone captured by this method 214,099,725 pounds of fish, with a value of 826,597 dollars, United States currency.

³ A full description as to detailed method of construction, size of twine, mesh, hanging of net and methods of using can be obtained by applying to the United States Division of Fisheries.

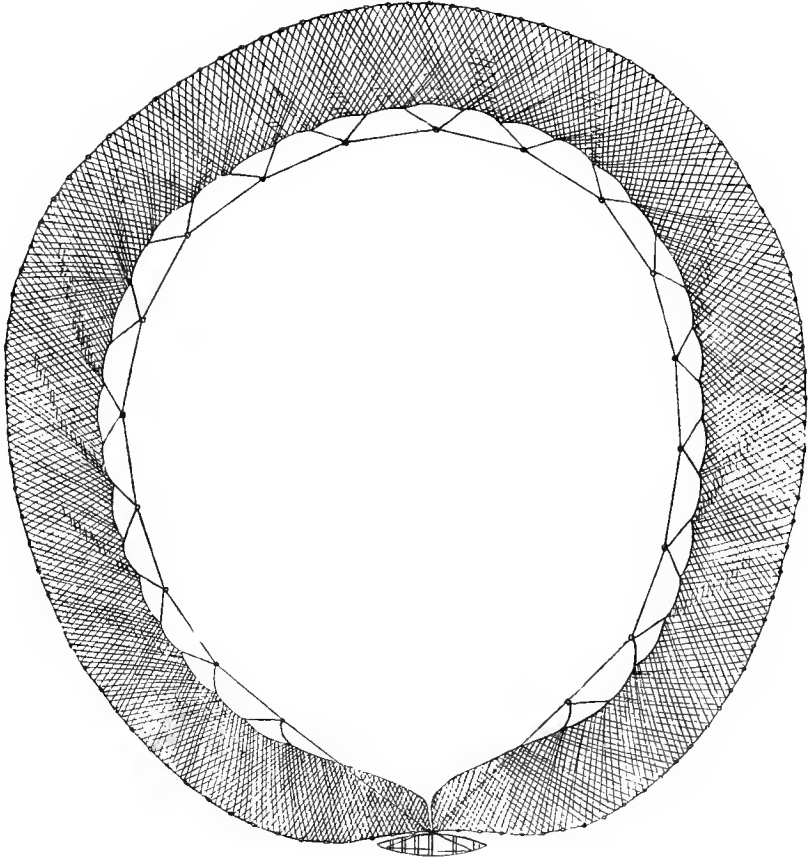

FIG. 3.—THE MACKEREL PURSE SEINE.

Purse seines (fig. 3).—One of the most effective nets used in the American fisheries is the purse seine. An ordinary, deep-water purse seine, such as is employed in the eastern mackerel fishing, is about 200

fathoms in length, and 20 to 25 fathoms in depth when it is hung, it being deeper in the center than at the extreme wings. The boat end of one wing is from 1 to 10 fathoms deep; the other end varies from 7 to 15 fathoms. It is made of three kinds of twine. The bailing-piece, which is a section of the net occupying about 10 to 12 fathoms along the center of the cork line and having about the same depth as length, is made of the stoutest twine. Beneath this, composing the remainder of the middle of the seine and extending to the bottom of the net, is a section knit of twine a size smaller. There is also a band of large twine, 15 meshes in depth, extending along the cork line of the seine on either side of the bailing-piece to the extremity of each wing. The remainder of the net is made of lighter twine. The lead and cork line are in the same position as in ordinary seines. This net is operated by a series of pursing ropes and rings, by means of which the bottom of the seine is drawn up and closed. Formerly this net was taken out in fishing schooners and when a shoal of fish was seen, it was placed in a seining boat, the shoal was surrounded by the net, the latter at once pursed, the vessel then brought alongside and the fish dipped out. Now, in some cases, the net is carried on a revolving table at the stern of a small steam-vessel or launch, and the surrounding of the shoal and pursing of the net is all done quickly and efficiently by steam. Frequently more fish are taken in this way than can be used in one day. In this event, they are put into a "spiller" or pocket, which is a form of live-box made of stout, coarse twine, and is attached to the side of the vessel, where it is kept in position by wooden poles or outriggers extending 15 feet from the vessel's side. This apparatus is nothing more than a big net bag 36 feet long, 15 feet wide, and 30 feet deep. This size will hold 200 barrels of live mackerel, but of course the spiller may be constructed of any dimensions. The purse net could probably be used with profit in catching the various kinds of mackerel (*masangui*, etc.) found in Philippine waters.

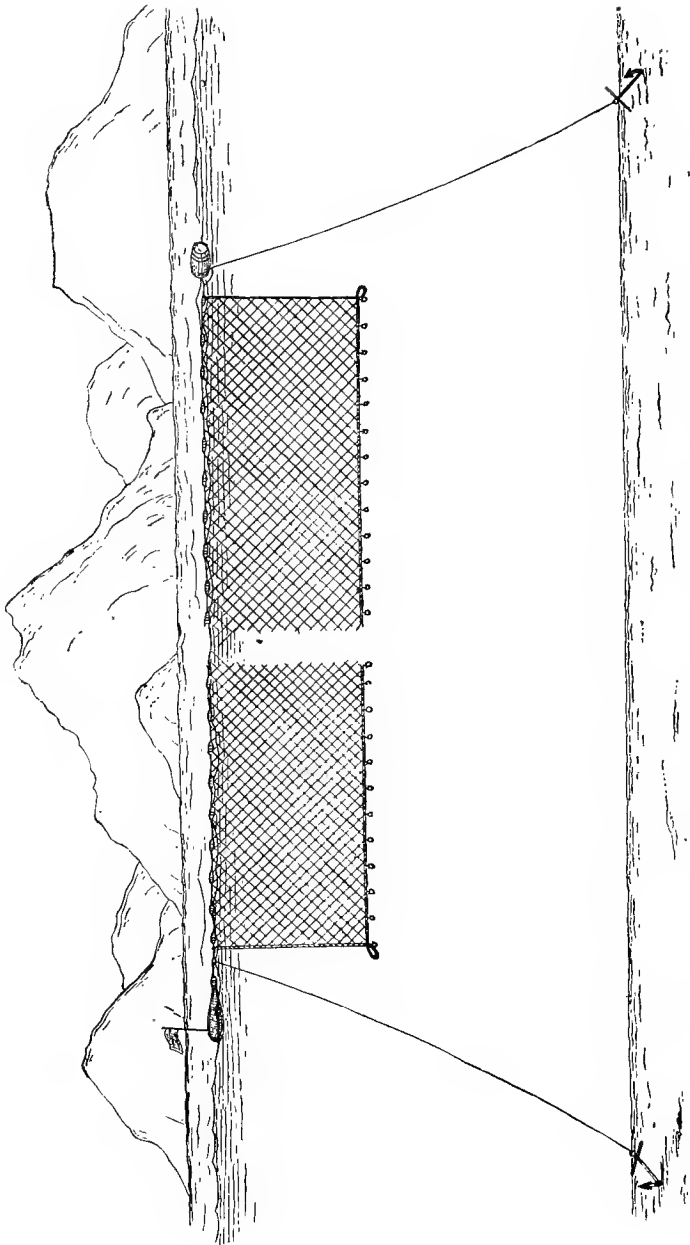

FIG. 4.—SHOWING METHOD OF SETTING GULL NETS AT THE SURFACE.

Gill nets (fig. 4).—The gill net is next in importance to the various kinds of seines. It is used chiefly in the herring fisheries, but in the Philippines large numbers of other kinds of fishes can profitably be taken by its means. This is especially true of the mullet, certain of the pompano, such as the *cassising* [*Scomberoides toloo-parah* (Rüppell)], *atoley* (*Caranx boöps* Cuv. et Val.), *mataan* (*Caranx freeri* Evermann et Seale), and such fish as the various kinds of snappers, for example the *bitilla* [*Lutianus fluviflamme* (Forskål)], *alangot* [*Lutianus lineatus* (Quoy et Gaimard)], and *pukit* [*Nemipterus nemurus* (Bleeker)]. These nets may be set either at the surface or at the bottom (see figs. 4 and 5), depending upon the kind of fish one wishes to catch. In the mullet fishery the nets are frequently allowed to drift with the current.

An ordinary herring net, 15 to 20 fathoms long and 2 to 3 fathoms deep, has a mesh varying from 2.25 to 2.75 inches. A herring vessel of the Atlantic fishery usually carries eight to fifteen of these nets with anchors and hangings. Off the coast of Palawan I have caught 120 fishes of good size in a single 20-fathom gill net in one night. So far as my experience goes this has been found the most successful net for use in the Philippines. The greatest drawback is the damage inflicted by sharks (fig. 5).

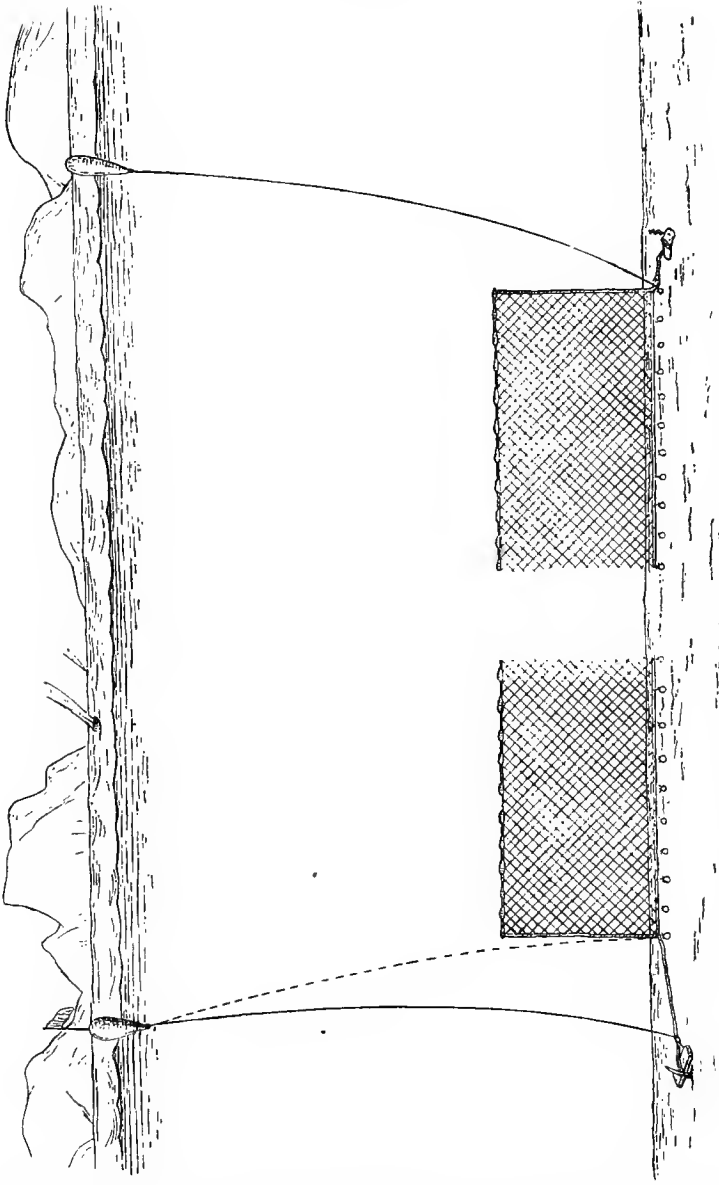

FIG. 5.—SHOWING METHOD OF SETTING GILL-NETS AT THE BOTTOM.

Paranzella, drag net.—San Francisco seems to be the only place in the United States where this form of net is used. The nets are from 50 to 75 fathoms in length, with short wings and a long bag and are from 6 to 8 feet high. A small steam-launch is used at each end and the net is dragged along the bottom. The meshes of the wings of the net are $1\frac{1}{2}$ inches wide, the lower side which drags the bottom is made of coarse twine with a mesh from 2 to 4 inches in width. Frequently, a

tug load of fish is secured at one haul. This net could only be used on smooth, sandy bottom free from coral, and employed chiefly to catch flatfish, flounders, etc.

Pound nets.—Many kinds of pound nets are used in the American fisheries, but as this manner of fishing is well known and used in the Philippines in the various forms of corrals or *baclods* no descriptions are necessary. Notwithstanding the expense of building, it is one of the most successful methods of fishing as is attested by the hundreds of corrals in the Islands.

Fyke nets.—These nets, which are usually of small size and consequently not very expensive, could be profitably used for the capture of the various species of catfishes, *dalags*, *martinicos*, etc.

OTHER METHODS OF FISHING.

Trawl lines.—While trawl-line fishing was formerly employed almost exclusively for catching codfish, it is now used to capture a great many varieties. At Monterey, California, I noticed the trawl lines being operated with good success to catch several kinds of fish, such as rock-cod, etc. They might be used with profit in the Philippines for such fish as the groupers (*Serranida*), the *mulmul*, and others which take the hook freely at the bottom. They are especially effective in taking eels.

The trawl line consists of a strong ground-line 300 fathoms in length, to which is fastened at intervals of one fathom a line 3 feet long to which a hook is attached. The hooks are baited and the ground-line anchored at the bottom with a buoy to indicate its location. A line for pulling it up is attached to it.

Live-cars.—Next to improving the method of catching the fish, the most important thing is to devise means by which they may be kept alive until they are wanted by the consumer. To this end the live-car is brought into requisition in several places, especially in tropical countries. This device is a very simple contrivance consisting of a square or quadrangular box constructed of slats placed close enough together to keep the fish in, but far enough apart to allow of a free circulation of water. The cars are immersed in the water and the fish are kept inside until they are wanted by the purchaser. At Key West the fishing schooners are now usually provided with wells in which the water is kept circulating, and in this way the fishermen are able to keep the fish alive. The fishing boats at Honolulu have wells with perforated sides through which the water circulates freely. At this place live-boxes or cars are in common use. Some of these are very large and are kept anchored close to the fish market. The purchaser selects his fish from the wharf, it is then dipped out of the live-box and delivered. Some modification of this plan could be adopted in the Philippines, but it is only feasible where the market is near salt water.

LOCATION OF FISHING BANKS.

The following fishing areas or banks seem to be the most prolific so far as I have investigated and they would well repay working.

The vicinity of Sitanki is practically all a fishing bank, being well supplied with organic life upon which fishes feed. The trade at this place is now in the hands of the Chinese. There are numerous good fishing banks in the vicinity of Zamboanga, especially off San Ramon and along the Basilan coast; one a few miles south of Cagayan Sulu and a number along the coast of Palawan. Some very prolific banks exist near the Cuyo Islands and close to Masbate and Cebu. The bank which chiefly supplies the Manila market is located near Corregidor Island.

Doubtless numerous other fishing banks can be found; in fact, wherever we encounter a comparatively shallow area of from 5 to 20 fathoms, with plenty of sea moss and rich in small marine organism, we may be assured of finding it well stocked with fishes. Sooner or later these places will all be accurately located and worked. What is needed is men of experience who will give the industry their entire attention; such people will win profitable results.

THE CHIEF FOOD FISHES IN PHILIPPINE WATERS.

Filipino.	Moro.	English.	Scientific.
Aguut		Grunts	<i>Sciaenidae</i> .
Aligasín		Mullet	<i>Mugilidae</i> .
Alumahan, mataán	Salay salay	Pompano	<i>Scorpaen microlepidotus</i> Rüppell.
Ayuñgin	Lagohot	Grunt	<i>Pristipoma husta</i> (Bloch).
Baga-baga	Bungu-bungu	Soldier fish	<i>Myripristis murdjan</i> (Forskål).
Bagaong, baraongan	Bigaong	Grunt	<i>Therapon jarbua</i> (Forskål).
Bakoko	Gaud-gaud	Porgy	<i>Sparus calamora</i> Russell.
Balang		Flying fish	Family <i>Ecoetidae</i> .
Balila		Band fish	Family <i>Trichiuridae</i> .
Banak, lumitog	Banak	Mullet	<i>Mugil cephalus</i> Linn.
Bañgos, banglot	Bangellus	Milkfish	<i>Chanos chanos</i> (Forskål).
Barangan	Tamban	Herring	<i>Ilisha havenii</i> (Bleeker).
Barikudo, babayo	Lambanak	Barracuda	<i>Sphyræna langsar</i> Bleeker.
Bia		Gobies	Family <i>Gobiidae</i> .
Bia, bunog	Tamangka	Goby	<i>Gnathob pis deltoides</i> (Seale).
Biang-itim	Tigbashay	Goby	<i>Glossogobius biocellatus</i> (Cuv. et Val.).
Biang-puti, balla	Kapalo	Goby	<i>Glossogobius giuris</i> (Ham. Buch.).
Bidbid		Ten-pounder	<i>Elops saurus</i> Linnaeus.
Bitilla, apahap, biquilla	Bahaba	Drum	<i>Umbrina russelli</i> Cuv. et Val.
Bonito, tangi	Sobad	Oceanic bonito	<i>Gymnosarda pelamis</i> (Linn.).
Buan-buan		Tarpon	<i>Megalops cyprinoides</i> Bronsonet.
Buguing		Half-beaks	Family <i>Eraconidae</i> .
Bungayngay, bunog	Tamangka	Goby	<i>Rhinogobius oxyurus</i> Jordan et Seale.
Buteteng-saguing		Puffers	<i>Spherooides lunaris</i> Bloch et Schn.

THE CHIEF FOOD FISHES IN PHILIPPINE WATERS—continued.

Filipino.	Moro.	English.	Scientific.
Butete	Tingga-tingga	Puffers	Family <i>Tetraodontidæ</i> .
Cabasi	Tatik	Bustard shad	<i>Anodontostoma chacunda</i> Ham.-Buc.
Dalag	Dalak	Mud fish	<i>Ophiocephalus striatus</i> Bloch.
Dangat, bagsang	Totok	Wharf fish	<i>Priopis wrotenia</i> Bleeker.
Dilis, Monamon	Anakbat	Anchovy	<i>Anchovia commersoniana</i> (Lacépède).
Dumpilas	Tatik	Anchovy	<i>Anchovia dussumieri</i> Bleeker.
Espada		Band fish	Family <i>Trichiurida</i> .
Guno, ti-i	Guno'e	Silverside	<i>Atherina temminckii</i> (Bleeker).
Garropa		Grouper	Family <i>Serranidæ</i> .
Hasa-basa		Japan mackerel	<i>Scomber japonicus</i> Houttuyn.
Hito, paltat		Catfish	<i>Clarias magur</i> (Ham.-Buc.).
Igat, quiet	Taguibns	Rice-paddy eel	<i>Jenkinsiella nectura</i> Jordan.
Kabasi	Tatik	Basling shads	Family <i>Dorosomatidæ</i> .
Kabayo-kabayohan	Undok	Sea horse	Genus <i>Gasterotokeus</i> .
Kalaso, daldalag	Tigbasbay	Lizard fish	<i>Saurida argyrophaneus</i> Rich.
Kanduli kanduli	Gagu'e	Catfish	<i>Neluma nasuta</i> (Bleeker).
Kapalo, bunog	Kapalo	Goby	<i>Ilana cacabet</i> Smith et Seale.
Kitang		Butter fish	Family <i>Ephippidæ</i> .
Lapo-lapo, garopa	Kukkut	Groupers	<i>Epinephelus merra</i> Bloch.
Lawin, bolader	Bengke	Flying fish	<i>Parezoceetus mento</i> (Cuv. et Val.).
Malakapas, icoran	Porok	Mojarritas	<i>Xystema kapas</i> (Bleeker).
Mamali		Thread fin	Family <i>Polymenidæ</i> .
Martínico, araro	Piit	Climbing perch	<i>Anabas scandens</i> Daldorf.
Moong, mamong	Bangka	Cardinal fishes	<i>Amia chrysoptoma</i> (Bleeker).
Mumul, molmol	Lammon	Wrasse-fishes	<i>Cherops unimaculatus</i> Cartier.
Mulmul, Molmol	Ogos	Parrot fish	<i>Callyodon latifasciatus</i> Seale et Bean.
Pagui-, pagui	Kiampao	Sting ray	<i>Dasyatis kuhli</i> (Müller et Henle).
Pating, i-yo	Kaitan	Shark	<i>Scolliodon walbecchii</i> (Bleeker).
Sakutin		Red fish	Family <i>Triacanthidæ</i> .
Samaral, malaga	Bel-long	Siganuo	<i>Siganus vermiculatus</i> Cuv. et Val.
Sapsap	Sapsap	Slip mouths	<i>Leognathus splendens</i> (Cuv.).
Saramullete, balaki	Mangentut	Goat fish	<i>Upeneus sulphureus</i> Cuv. et Val.
Siliñasi, bilis	Pinatay	Herring (young)	<i>Harengula</i> sp.
Siliu, sirin	Celo	Gar fish	<i>Tylosurus giganteus</i> (Tem- minck et Schlegel).
Smbbilang, ito	Baki'e	Catfish	<i>Plotosus anguillararis</i> (Bloch).
Sunog, uram-uram	Kanang	Flatheads	<i>Platycephalus insidiator</i> (Fors- kål).
Talakitok		Cavallas	Family <i>Cuvungidæ</i> .
Talakitok, tarakotokan	Anakbung	Cavallas	<i>Caranx sepiusciatus</i> Quoy et Gaimard.
Talang-talang, saleng- saleng.	Tangtang	Slipery dick	<i>Scomberoides totooparah</i> (Rüppell).
Tanguingne	Tangi	Spanish mack- erel.	<i>Scomberomorus commersoni</i> Lacépède.
Tulis, tulisan	Tamban	Sardine	<i>Sardinella clupeioides</i> (Bleeker).
Tunsoy, Bilis	Tamban	Herring	<i>Harengula moluccensis</i> (Blec- ker).

ILLUSTRATIONS.

PLATE I. Dili, anchovy (Family <i>Engraulidae</i>). <i>Aukoria commersoniana</i> (Lacépède).	
II. Silinasi, herring (Family <i>Clupeidae</i>). <i>Harengula moluccensis</i> (Bleeker).	
III. Gunoe, silverside (Family <i>Atherinidae</i>). <i>Atherina forskalii</i> Rüppell.	
IV. Tanguingue, Spanish mackerel (Family <i>Scombridae</i>). <i>Scomberomorus commersoni</i> Lacépède.	
V. Dalag, mud fish (Family <i>Ophicephalidae</i>). <i>Ophicephalus striatus</i> Bloch.	
VI. Mayamaya, red snapper (Family <i>Lutjanidae</i>). <i>Lutjanus doddecacanthus</i> Bleeker.	
VII. Talakitok, pompano (Family <i>Carangidae</i>). <i>Caranx speciosus</i> Forskål.	
VIII. Lapo-lapo, grouper (Family <i>Serranidae</i>). <i>Epinephelus megachir</i> (Richardson).	
IX. Banak, mullet (Family <i>Mugilidae</i>). <i>Mugil cephalus</i> Cuvier.	
X. Bauḡos, milkfish (Family <i>Channidae</i>). <i>Chanos chanos</i> Forskål.	Facing page—
FIG. 1. (In text.) The guardian of a fish pond with his family, and the jars or <i>polyok</i> in which the fry are transported.	520
2. (In text.) Model of a <i>bauḡos</i> pond system.	520
3. (In text.) The mackerel purse seine.	522
4. (In text.) Showing method of setting gill nets at the surface.	524
5. (In text.) Showing method of setting gill nets at the bottom.	526
	531

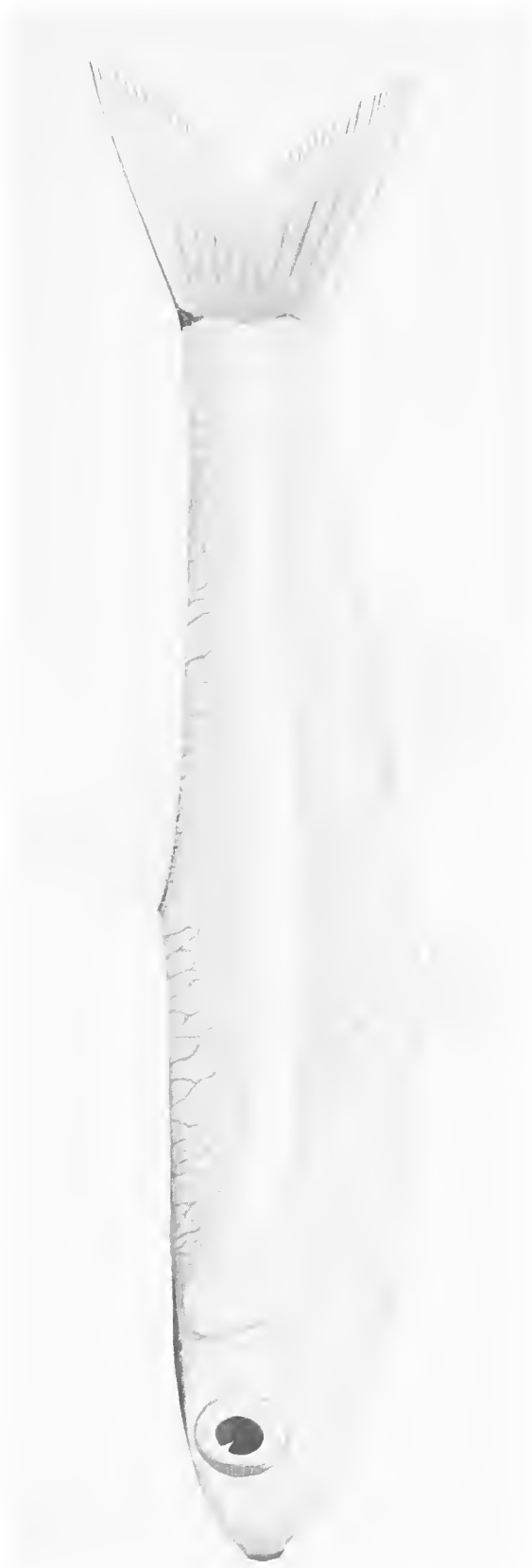

PLATE I. DILIS, ANCHOVY.

Anchoa commersoniana (Lacépède).

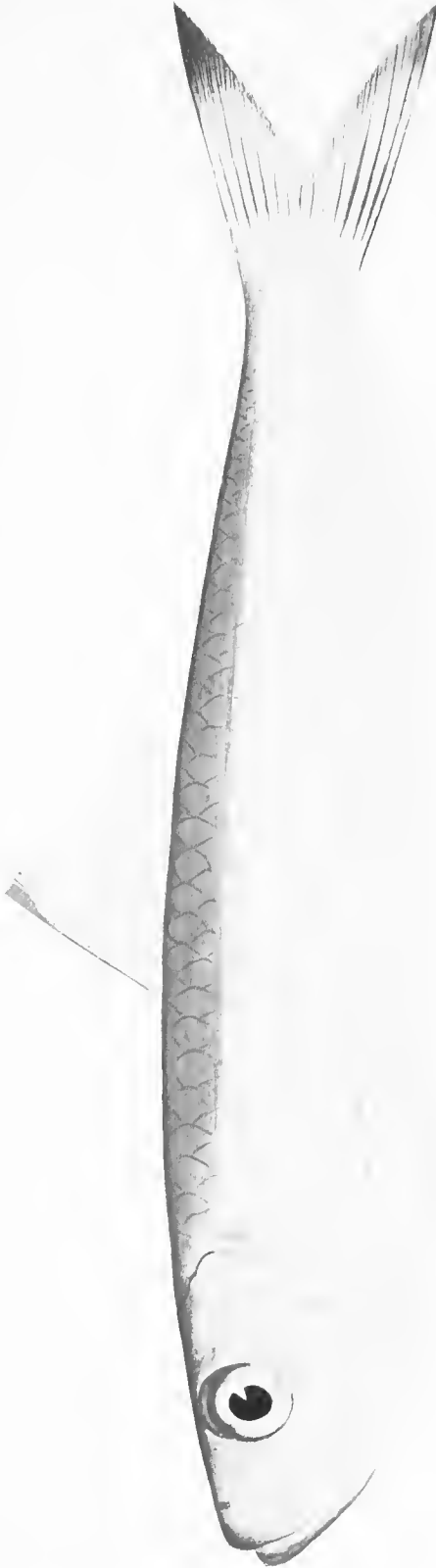

PLATE I. SILIÑIASI, HERRING.
Harengula malaccensis (Ehrenb.)



PLATE III. GUNOC, SILVERSIDE.
Atherina Forskali: Ruppell.



PLATE IV. TANGUINGUE, SPANISH MACKEREL.
Scomberomorus commersoni Lacépède.



PLATE V. DALAG, MUDFISH.
Family Ophichthidae.



PLATE VI. MAYAMAYA, RED SNAPPER.
Lutjanus decacanthus Bleeker.



PLATE VII. TALAKITOK, POMPANO.
Caranx xanippus Forskal.

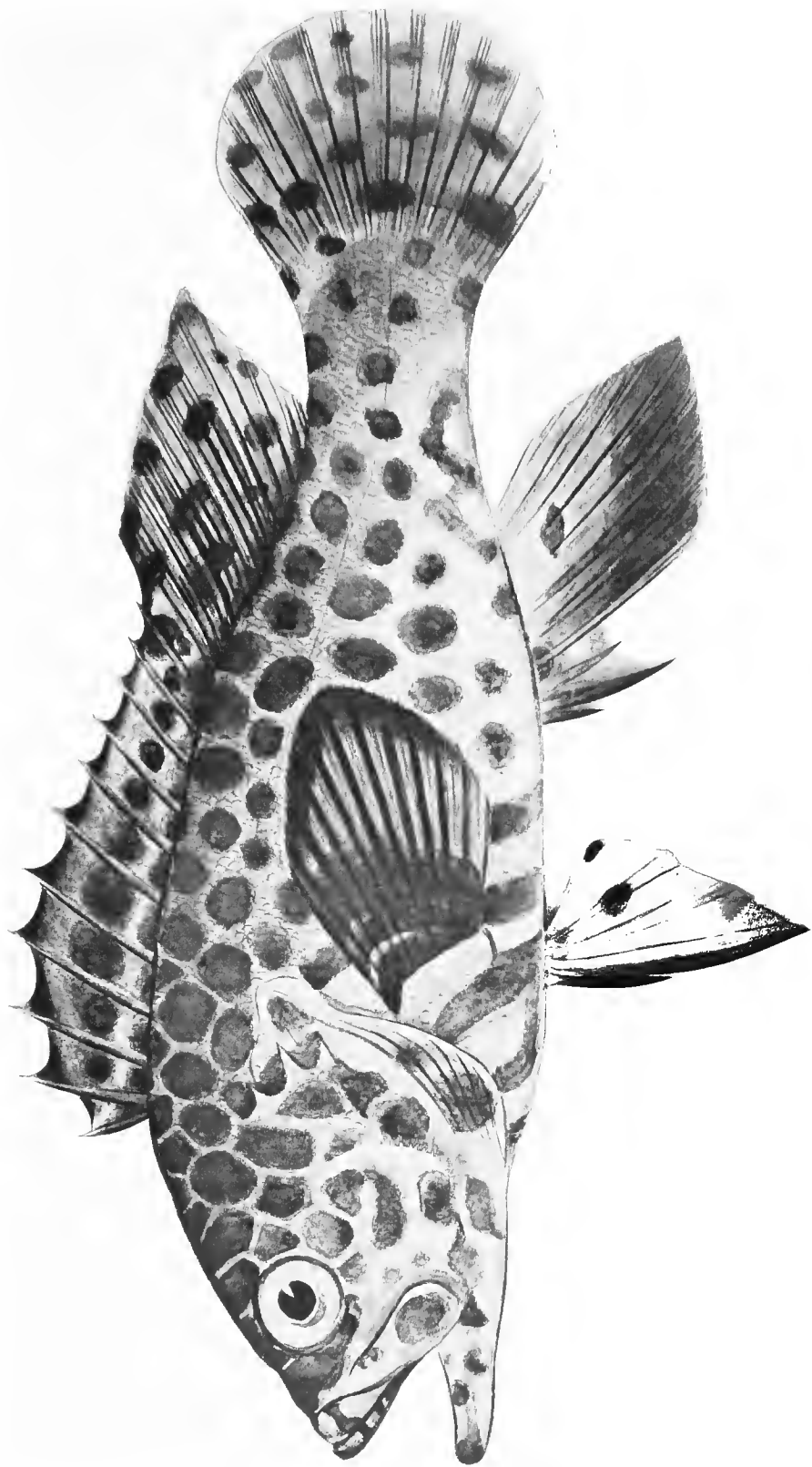

PLATE VIII. LAPO-LAPO, GROUPEE.
Epinephelus mequahir (Richardson).



PLATE IX. BANAK, MULLET.
Mugil cephalus Cuvier.

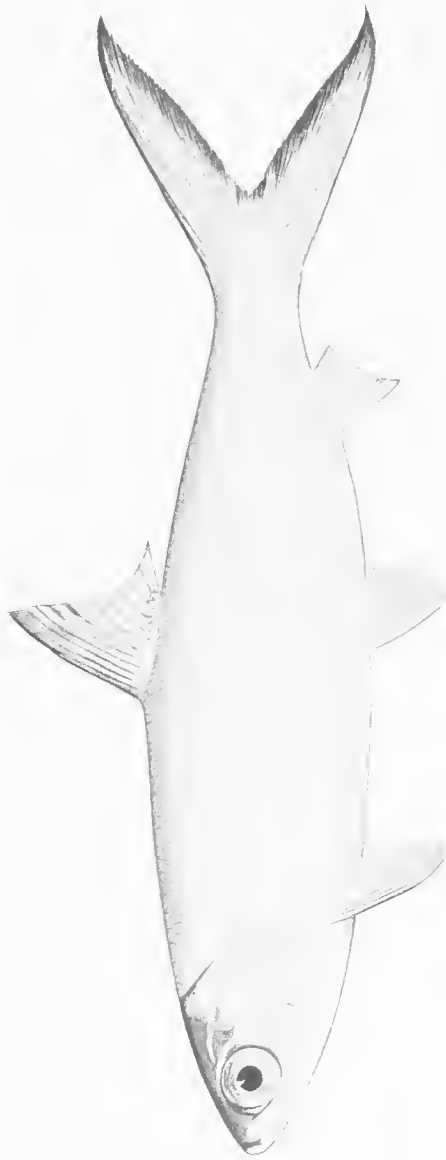

PLATE X. BANGOS, MILKFISH
Chanos chanos Forskål.

THE FISHERY RESOURCES OF THE PHILIPPINE ISLANDS: II. SPONGES AND SPONGE FISHERIES.

By ALVIN SEALE.

(From the Section of Fisheries, Biological Laboratory, Bureau of Science.)

INTRODUCTION.

The past year has marked the opening of the Philippine sponge fisheries from a commercial standpoint, some thirty thousand sponges having been shipped from the Islands during the year. The greater part of these were sold in Singapore for export to London. Philippine sponges are new products to the trade and many of them are slightly different from those usually handled and therefore the prices obtained varied greatly, in some instances, no doubt, being below the real value of the export.

Specimens of all the different varieties of Philippine sponges at present obtainable were taken to the United States and shown to Dr. H. F. Moore, of the United States Bureau of Fisheries. They were compared with specimens from Florida, Cuba, and the Mediterranean. After this the same specimens were taken to some of the largest wholesale sponge dealers in New York and San Francisco, who examined them with great interest, suggested commercial names for those new to the trade, and so far as possible, gave quotations of prices of sponges of the latter class among the samples. The facts I have so far collected are given below.

SPONGES IN GENERAL.

A sponge when in its native state (see Pl. I) closely resembles a boiled plum pudding covered by a thin, dark skin. It is quite different in appearance from the ordinary sponge of commerce which is merely the bleached skeleton of the animal.

Sponges are usually classed by themselves in the faunal subkingdom *Porifera*; most of the sponges belong to the division *Keratosa*; the great majority of the Philippine forms to the genus *Euspongia*.¹

¹ It is intended in a later paper to give a small check list with the scientific names of all the Philippine sponges.

All of the several varieties of soft sponges found in the Philippines are of more or less commercial value. In addition to these, an almost unlimited variety of silicious sponges is encountered; the fiber of these is now being used in some countries as a substitute for asbestos.

PHILIPPINE SPONGES OF COMMERCIAL VALUE.

THE SHEEP'S-WOOL SPONGE (PLATE II).

The sheep's-wool sponge is the most valuable variety found in the Philippines. It has a strong, elastic fiber, resembling in every respect the well-known sheep's-wool or bath sponge of Florida and it probably grows to about the same size. The only place where this sponge at present is known to occur in the Philippines is at Siasi, but doubtless it will also be found around Tawi-Tawi. It would be to the advantage of those interested in sponging to give particular attention to the finding and developing of these sponges, as they are well-known to the trade, are always in demand, and the supply is becoming limited. There would be no difficulty in marketing any quantity in the United States or Europe where the product would bring from 8 to 20 pesos (4 to 10 dollars, United States currency) per kilo in wholesale lots. The specimen figured is of second grade and the price quoted by the largest New York dealer was ten pesos per kilo.

THE PHILIPPINE ZOMOCCA SPONGE (PLATE III).

This is a very tough, elastic sponge of moderately coarse fiber, usually rather flat in shape. The organisms grow in shallow water of 1.2 to 2 meters' depth, on a hard rock bottom. Specimens 30 centimeters in diameter are frequently found. This sponge seems to be intermediate in grade between the sheep's-wool and grass sponges; some of the dealers classing it with the former and others with the latter. All admit it to be different from any of the American forms. Dr. Moore considered it to be the best among those submitted to him and suggested the name "flat bath sponge" for it. However, a comparison with a large number of European sponges on the market induced me to follow the suggestion of one of the sponge dealers and term it the Philippine Zomocca sponge because it most nearly resembles the well-known commercial form, the European "Zomocca."

This sponge is found in considerable numbers in the waters around Tawi-Tawi and the nearby islands; in deeper water, it will be of better quality. In all probability it occurs near other islands of the Archipelago.

The Philippine Zomocca sponge would find a ready market both in the United States and in Europe, the wholesale price quoted being from two to six pesos per kilo.

THE PHILIPPINE ROCK SPONGE (PLATE IV).

No commercial name exists for this organism. It resembles the Florida yellow sponge to a certain extent, but the fiber is not as strong and the texture is considerably softer. It is very porous and covered with small tufts. It grows attached to bowlders and rocks in water of 1.5 to 5 meters in depth, reaching a diameter of 40 centimeters. Some of the dealers whom I consulted designated this as a good sponge; others considered it to be almost worthless. As a matter of fact it is not very durable and therefore would probably not bring a large price. It is only known from the Island of Sitanki, but it probably will be found throughout the Sulu group.

THE PHILIPPINE REEF SPONGE (PLATE V).

This is a beautiful sponge of very soft, closely woven fiber; unfortunately it is quite fragile. This fact greatly detracts from its value; however, it is of a slightly better quality than the majority of American reef sponges. This specimen was termed "glove sponge" by some of the wholesale dealers of New York, but reef sponge is undoubtedly a better name. It is quite abundant in many places in the southern Philippine Islands, especially so at Sitanki, where it is found in very shallow water, usually growing on the reefs among the moss and seaweed. It reaches a diameter of 20 to 25 centimeters. It is a fine, soft, bath sponge, but because of its fragile nature its period of usefulness is short. Considering its abundance, cheapness, and the ease with which it is gathered, the probabilities are that it will play an important part in the Philippine sponge industry.

The prices quoted on this sponge ranged from 2 to 3 pesos per kilo.

PHILIPPINE GRASS SPONGES (PLATE VI).

The group of grass sponges which embraces a variety of forms representing distinct genera, contains the great majority of sponges found in almost all Philippine waters; they are especially abundant at Sitanki, Tawi-Tawi and Siasi to the south, and at Masbate and Cebu farther to the north. In these places they outnumber all the other sponges combined. They are usually encountered on reefs, in water of from 40 centimeters to 1.5 meters in depth. They are from 8 to 30 centimeters in diameter.

The best grade of Philippine grass sponge (shown by Pl. VI) is of a closely woven, fine, and soft texture; it is in every respect most desirable for bathing or general use. More than thirty thousand of these sponges were taken from the beds at Sitanki during the past year, but many were of very small size and also poorly cleaned, so that the price obtained was very low. Wholesale dealers gave the value of my specimen

at 2 pesos 40 centavos per kilo for the best quality and 40 centavos to 1 peso for the smaller kind, although I have seen sponges of the same classes marked in the retail trade at from 50 cents to 2 dollars, United States currency, each. The Philippine grass sponge, in comparison with any of the American or Cuban varieties, is regarded by wholesale dealers as being softer and stronger and of a better grade. It is probable that when these sponges are better known the price will be materially increased.

THE PHILIPPINE SILK SPONGE.

A small variety of the grass sponge, usually of 10 to 15 centimeters in diameter is frequently associated with the preceding variety. It is characterized by an extremely soft, silky texture; in fact it is the softest sponge found in the Islands. Acting upon the suggestions of sponge dealers I have decided to designate it as the Philippine silk sponge. The silk sponge has been taken in shallow water at Tawi-Tawi and Sitanki and it will also probably be found near several other islands. It would be very useful as a toilet sponge for infants and should bring a slightly better price than the ordinary grass sponge.

THE SULU SEA BATH SPONGE (PLATE VII).

This is a grass sponge of very coarse, tough fiber. It is quite common near Sitanki in water of from 1.3 to 2 meters in depth; it attains a diameter of 60 centimeters or more. No sponges exactly like the Sulu Sea sponge are taken in the American fisheries and therefore the large dealers were not inclined to consider it at its full value, mainly, I believe, because of lack of familiarity with it. One dealer believes that to a certain extent it resembles the Florida yellow sponge, but it is tougher than the latter, and contrary to what might be expected, holds water well.

It could be used as a bath or horse sponge, for cleaning carriages, automobiles, large guns, or mortars, or as a stiffening for various fabrics.

The prices given for this variety are only 40 to 60 centavos per kilo, but these are probably much below the true value of the sponge and much less than they will be when it becomes known to the trade.

THE PHILIPPINE ELEPHANT'S-EAR SPONGE (PLATE VIII).

This is a true elephant's-ear sponge, but specimens so far examined do not seem to have the thickness of the Mediterranean variety; however, those secured from a depth of 15 to 30 meters are thicker and have a softer texture. The Mediterranean elephant's-ear is in great demand and brings high prices, and the Philippine variety from deep waters should compare favorably with it.

This sponge is used by glazers, and as padding in the more expensive racing saddles. The market seems to be almost entirely European, and no quotation of prices could be secured in the United States, because of the very small and unsatisfactory specimen in my collection. This

sponge is found in many localities throughout the Sulu Archipelago, but it seems to be especially abundant in the vicinity of the Island of Sulu. The pearl divers frequently bring up fine specimens.

THE TUBE SPONGE (PLATE IX).

This is a peculiar sponge found in the shallow waters at Sitanki. It is of very little if any commercial value, but as sponges are becoming rarer each year and as even the smallest clippings are being utilized, it may in time come about that even this sponge will have a value.

THE PREPARATION OF SPONGES FOR THE MARKET.

The sponges are first placed in their normal position, on a platform, the deck of a vessel, flat rock, or any place where they will not become filled with sand or dirt. They are left in the sun for two or three days until killed. They are then placed in a corral (usually built at the edge of the water), where they will be covered with water; they are squeezed out from time to time and allowed to remain in this place for from five to six days, large sponges requiring more time than the small ones. The shorter the time in which they are macerated in the corral, the better for the sponges, the object being to keep them in the water only for a sufficient period to permit them to be squeezed out and cleaned easily. The corral may be constructed of any size and in almost any manner, the object being to keep the sponges covered with salt water and free from dirt. If the enclosure is made simply by driving stakes in the ground, it is best to put in a floor of bamboo or boards to keep the sponges off the bottom and thus prevent them from rotting. Mr. John Byersdoffer, of Sitanki, constructs a floating enclosure of boards and slats with cracks sufficiently wide to permit the water to enter freely. (Fig. 1.) The box is about 4 meters long, 2 meters wide,

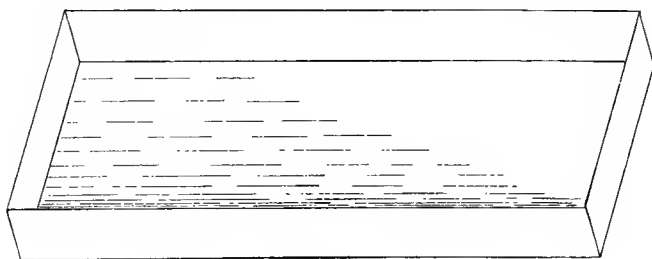

FIG. 1.



FIG. 2.



FIG. 3.

and 1.5 meters deep. Its advantages are that it keeps the sponges clean and it may be towed to any place; its own weight sinks it sufficiently to keep the sponges under water.

The cleaning is greatly facilitated by frequently squeezing out the sponges and a flat paddle of considerable weight may be used with good effect. (Fig. 2.) A washboard made by tacking a cleat 2 centimeters thick about 8 centimeters from each end of a wide board and then stretching galvanized wire netting of 2 centimeters' mesh over the cleats, tacking it to the ends of the board, is very useful. (Fig. 3.) This instrument is especially useful to remove the dead, black skin from the sponges. After five or six days in water, during which time the sponges have been thoroughly squeezed, they are washed out in clean, salt water and put in the sun to dry. They should still be kept in the same position in which they grow, otherwise they are apt to burn and become red. However, the red color should not be confused with that which many sponges naturally show in the center of their structure. The sponges may be strung on stout twine about two meters in length to facilitate handling them rapidly. Salt water only is used in curing. After the sponges are thoroughly dry they are ready to sack or bale for market. Great care should be taken that the sponges are thoroughly dry and clean, as the Philippine sponge can only obtain the best market if it is always shipped as a thoroughly cured, cleaned article.

BLEACHING SPONGES.

Sponges are always shipped to the general market in an unbleached condition, but the following method by R. F. Bacon, of the chemical laboratory, Bureau of Science, is very effective, doing the least damage to the fiber:

The sponges are placed in a saturated solution of potassium permanganate for two minutes, then transferred to fresh water and thoroughly washed. They are then squeezed out in a 10 per cent solution of sodium bisulphite until white; then again thoroughly washed in fresh water until all the chemicals are removed. They are afterward dried in the sun.

CULTIVATION AND GROWING OF SPONGES.

The growing of sponges for commerce has become established and it promises to result in a profitable industry.

Sponges are reproduced from eggs and by budding. The eggs are formed and fertilized within the body of the sponge; they develop into minute, free-swimming forms which are thrown out into the water through the large openings. After about twenty-four hours the young settle, become attached, and grow into separate sponges. Reproduction by budding, however, is the method taken advantage of in growing sponges from cuttings. The sponge should be placed on a wet board,

or better still, kept under water and cut with a very sharp knife into cubes of about 5 centimeters, care being taken to keep on as much of the thin, black skin as possible and not to squeeze the animal. These pieces are then placed on a thick, copper wire, about 4 centimeters apart, the wire being fastened to stakes at each end and about 15 centimeters above the bottom. (Fig. 4.) It is quite possible that rattan would do

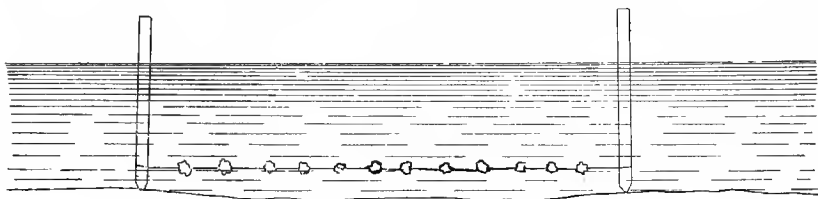

FIG. 4.

as well as copper wire; bamboo has been used with fair results. Within a day or two the sponges become attached to the wire and grow into fine, round organisms which have a much better shape than those growing naturally. These slips planted in Florida waters reached a marketable size in less than two years. The time required for them to grow in the Philippines is not known.

Sponges should always be propagated in water in which they grow well naturally and at about their normal depth. It is probable that improved varieties can be cultivated by uniting cuttings of superior sponges, and some of the best grade of European sponges might even be introduced with advantage.

It is my firm conviction that by care and work, not only in growing sponges, but by opening new beds, and fishing in deeper waters, a sponge industry amounting to several hundred thousand pesos per year may be built up in the Philippines.

Regulations governing the gathering of sponges in the waters of the Moro Province were passed in June, 1908, and copies of these regulations may be obtained from the Secretary of the Moro Province at Zamboanga.

LITERATURE.

The following is a very incomplete list of literature dealing with sponges, chiefly of this or related regions:

CARTER.

- Descriptions of Sponges from the Neighborhood of Port Philip Heads, South Australia, *Ann. & Mag. Nat. Hist.* (1885), V, 16, 277, 347; (1886), V, 17, 40, 112, 431, 502; (1886), V, 13, 34, 126.
 Contributions to our knowledge of the Spongida, *Ibid.* (1883), V, 11, 344; (1879), V, 3, 343; (1875), IV, 16, 126, 177; (1882), V, 9, 266, 346; (1869), IV, 3, 15; (1873), IV, 12, 17; (1872), IV, 9, 82; (1883), V, 12, 308; (1879), V, 3, 284; (1876), IV, 18, 226, 307, 388, 458.

DENBY.

The Sponge-fauna of Madras, *Ibid.* (1887), V, 20, 153.

Report on a Second Collection of Sponges from the Gulf of Manaar, *Ibid.* (1889), VI, 3, 73.

Report on Sponges of Ceylon, in Report on Pearl Oyster Fisheries of the Gulf of Manaar, Pt. III, Supplementary Reports (1905), 18, 57 to 246.

GRAY.

Notes on the Arrangement of Sponges, with the Description of Some New Genera, *Proc. Zoöl. Soc.*, Lond. (1867), 492.

HAECKEL.

Die Kalkschwämme, 1872.

HYATT.

Revision of the North American Poriferæ, *Mem. Boston Soc. Nat. Hist.* (1875), 2.

LINDENFELD.

A Monograph of the Australian Sponges, *Proc. Linn. Soc. N. S. W.* (1883), 9, 121, 310; (1884-85), 10, 283, 475, 481, 485.

Descriptive Catalogue of the Sponges in the Australian Museum, Sydney, London, 1888.

POLÉJAEFF.

Report on Keratosa. Collected by H. M. S. Challenger, 1884.

Report on the Carcareæ. Collected by H. M. S. Challenger, 1883.

RIDLEY.

Spongiidæ. Report on the Zoölogical Collections Made in the Indo-Pacific Ocean During the Voyage of H. M. S. Alert, Brit. Mus. 1884.

SCHULZE.

Die Familie Spongidiæ, *Zeit. f. wiss. Zoöl.* (1879), 32.

SMITH.

The Florida Commercial Sponges, *Bull. U. S. Fish Com.* (1897), 17, 225 to 240. Pl. 12 to 31.

WILSON.

The Sponges Collected in Porto Rico in 1899, *Ibid.* (1900), 2, 375.

On the Feasibility of Raising Sponges from the Egg, *Ibid.* (1897), 17, 241 to 245.

WHOLESALE SPONGE BUYERS.

For the benefit of those interested directly in the sponge industry I am appending a list of some of the sponge buyers in the United States who would be glad to correspond with those who have sponges for sale:

LASKER & BERNSTEIN, 161 William St., New York City.

COFFIN, REDINGTON, Co., 35 Second St., San Francisco.

LANGLY & MICHAELS Co., San Francisco.

AMERICAN SPONGE Co., 127 Larkin St., San Francisco.

A. ISAACS & Co., Beaman St., New York City.

LEONIS CLONNEY & Co., 39-41 Walker St., New York City.

SMITH, KLINE & FRENCH, Philadelphia, Pa.

JAMES H. KOHDS & Co., 117 E. Kinzie St., Chicago, Ill.

MEYER BROS., DRUGGISTS, St. Louis, Mo.

THE GREEK AMERICAN SPONGE Co., Chicago, Ill.

JOHN K. CHEYNEY, Tarpon Springs, Fla.

ILLUSTRATIONS.

- PLATE I. A Philippine commercial sponge in its natural state.
II. The Philippine Sheep's-Wool Sponge.
III. The Philippine Zomocca Sponge.
IV. Philippine Rock Sponge.
V. The Philippine Reef Sponge.
VI. The Philippine Grass Sponge.
VII. The Sulu Sea Bath Sponge.
VIII. The Philippine Elephant's-Ear Sponge.
IX. The Tube Sponge.
- FIG. 1. (In the text.) The Byersdoffer floating corral.
2. (In the text.) The Byersdoffer paddle.
3. (In the text.) The Byersdoffer sponge washboard.
4. (In the text.) Sponges planted on copper wire.

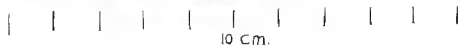

PLATE I.

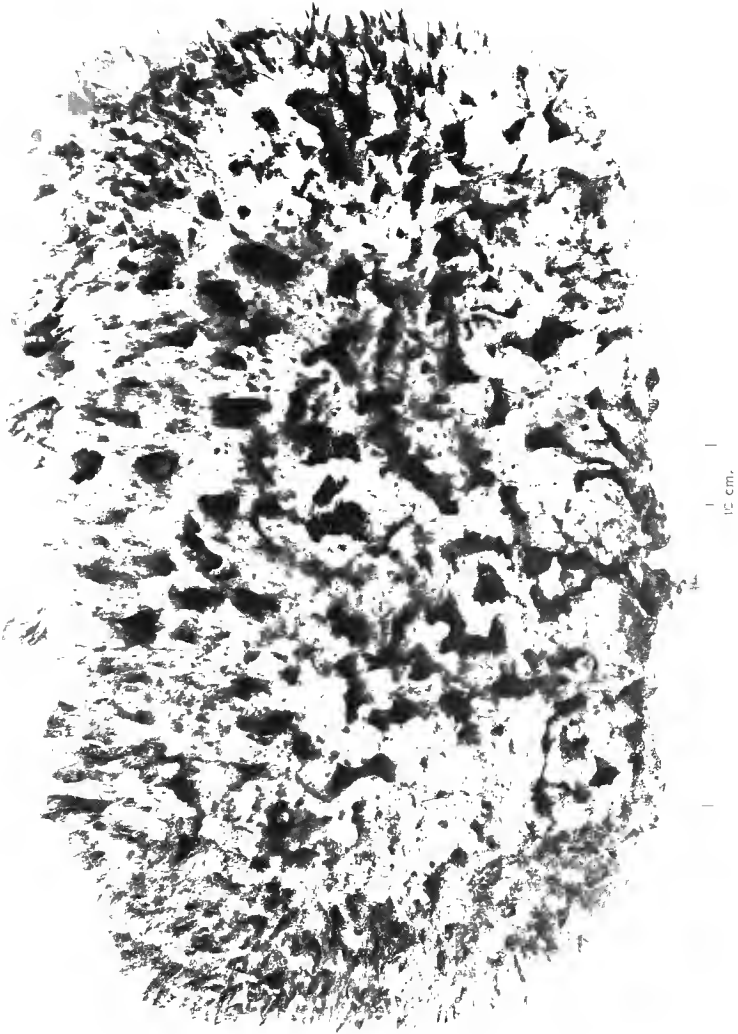

PLATE II.

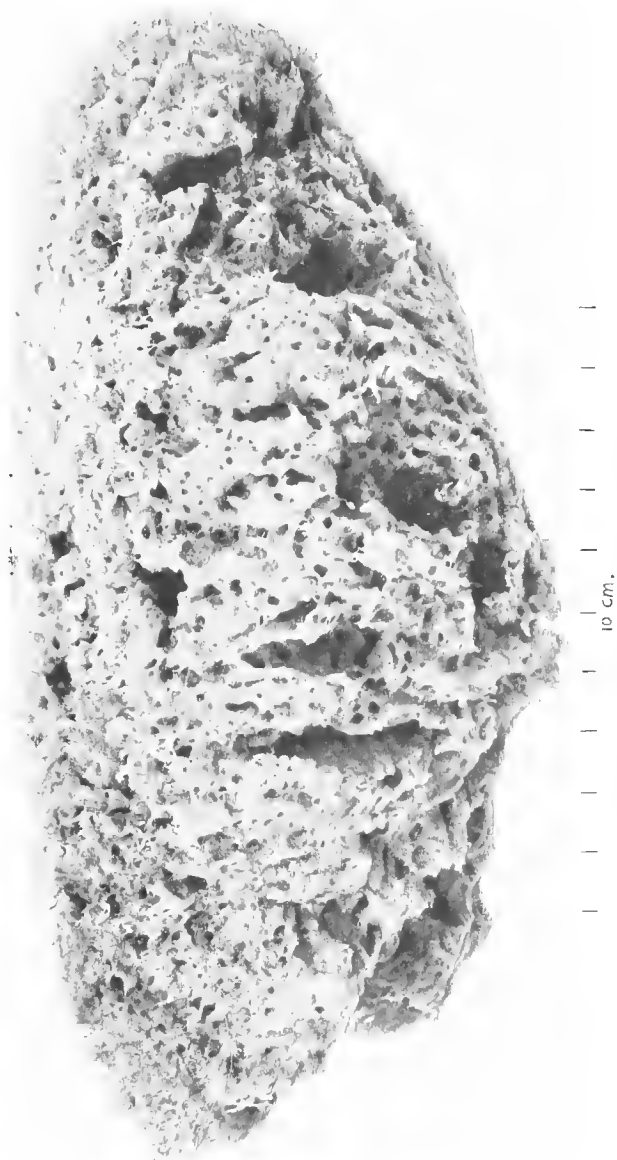

PLATE III.

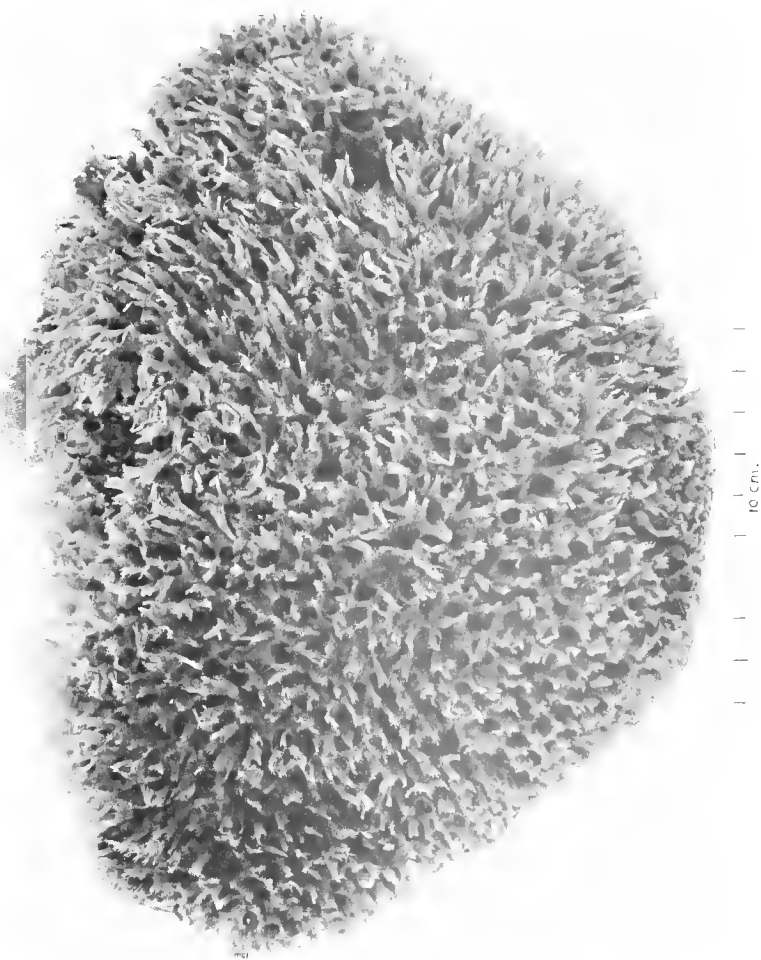

PLATE IV.



PLATE V.



PLATE VI.

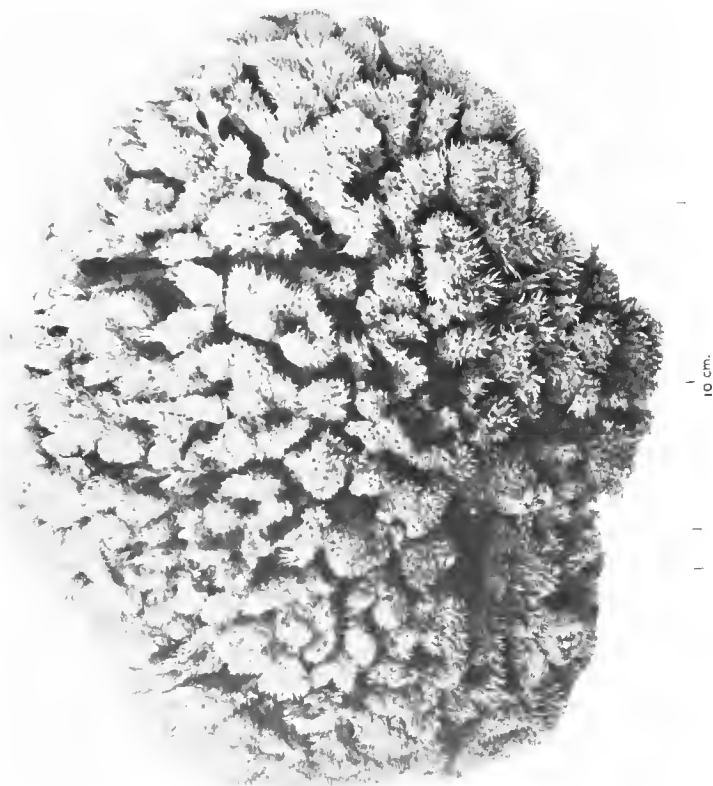

PLATE VII.



PLATE VIII.



PLATE IX.

THE PHILIPPINE
JOURNAL OF SCIENCE

D. ETHNOLOGY, ANTHROPOLOGY, AND
GENERAL BIOLOGY

VOL. V

JULY, 1910

No. 2

THE FISHERY RESOURCES OF THE PHILIPPINE ISLANDS.
PART III, PEARLS AND PEARL FISHERIES.¹

By ALVIN SEALE.

(From the Section of Fisheries, Biological Laboratory, Bureau of Science, Manila,
P. I.)

INTRODUCTION.

During the past ten years the writer has been engaged, as time would permit, in making a study of pearls and pearl fisheries. In 1900, a year was spent in the fisheries of Paumotu and Gambier Islands and in 1902 the fisheries of Australia and the Solomon Islands were visited; during the past year considerable time was given to a study of the pearling grounds of the Philippine Islands.

So far as possible, a careful study has been made of the development, life history and habits of the pearl oyster, chiefly with the view of increasing its value as a commercial asset. Experiments relating to pearl growth, development and culture have been inaugurated; and a large number of both hard and soft sections through pearls from various localities have been made in order to throw additional light on the direct cause of their origin and growth.

The object of the present paper is to give the results of these observations and a general review of our present knowledge of the subject, with the hope that such results may lead to increased interest in the Philippine pearl fisheries and to their greater development.

¹ Part I of this series appeared in *This Journal* Sec. A (1908), 3, 513; Part II, *Ibid.* (1909), 4, 57.

PHILIPPINE PEARL OYSTERS.

There are two varieties of pearl oysters in the Philippines which are of considerable commercial importance: One, called the gold lip pearl shell, Doctor Pilsbury kindly informs me is doubtless *Margaritifera maxima* Jamson² (see Plate III, figs. 1 and 2); the other, the black lip pearl shell, is *Margaritifera margaritifera* (Linnæus). (See Plate IV, figs. 1 and 2.) The gold lip shell is by far the most important, it being the variety chiefly sought in commercial ventures, its market value being from 30 to 80 pesos³ per picul of 63.3 kilos (139.5 pounds). This shell, when mature, is usually from 180 to 230 millimeters (7 to 9 inches) in diameter and weighs from 1.82 to 2.3 kilograms (4 to 5 pounds); shells weighing more than 5 kilograms (11 pounds) have been found. This species occurs in waters of from 5 to 20 fathoms throughout the Sulu Archipelago, and is probably more or less abundant throughout the entire Philippine group.

The black lip shell is a much smaller variety, rarely exceeding 150 or 180 millimeters (6 or 7 inches), with a weight of from 1 to 1.5 kilograms (2 to 3 pounds), although usually it is much smaller. It is common along the shores of almost all the islands of the Philippine Archipelago, and is of much less value commercially than the gold lip shell, being in but little demand and selling for about 13 pesos per picul. This form usually gives a large yield of pearls which are of comparatively little value, as they generally are small, irregular in shape and of a gray or dusky color.

In the year 1886 a paper was published in Bergen, Norway, which contained the following interesting statement regarding the Philippine pearl fisheries:

The Philippine Islands produce great quantities of pearl shell. In 1877, 155 tons were exported. In 1878, 152 tons, valued at 164,720 pesos were exported. In 1879 the value of exported pearl shell was 155,802 pesos. The entire region from Tawi-Tawi to Basilan is a continuous pearl oyster bed; the Sulu fisheries are the largest and most productive of any in the East Asiatic waters. The pearls are famous, and the shell has a fine luster. Labuan is the chief market. The yield is decreasing.

It will be of interest to compare the above account of the fisheries of thirty years ago with those of the present time. During the year 1907 there were exported from the port of Jolo 154,918 kilos (340,820 pounds) of pearl shell, valued at 119,045 pesos; and during the same period the product exported from Zamboanga was valued at 45,254 pesos, making a total of 164,399 pesos from the Moro Province alone, which shows a substantial increase rather than a decline in the fisheries. The above value

² Revised Nomenclature of Pearl Oysters. *Proc. Zool. Soc. London*, (1901), 1, 392.

³ One peso equals fifty cents U. S. currency.

is of the shell alone; that of the pearls secured during this time is unknown, but doubtless it amounted to several thousand pesos.

No export duty is charged on shell, but wharfage to the amount of 1.50 pesos per ton is collected.

The price of shell at the present time is from 60 to 100 pesos per picul for those of the first class of the gold lip variety, and about 20 pesos per picul for the black lip variety. The picul is counted at 63.3 kilograms (139.5 pounds, 16 piculs to the ton). Almost all the shell is sent either to Singapore or to Europe. There is one button factory located in Manila which has a capacity, when running constantly, of about 6,000 gross per month, requiring about 300 tons of shell per year; otherwise, all the shell is exported.

During the past year about 56 tons of shell were taken from the Davao pearl bed. These were of very large size and first class in every respect. They gave a very small yield of pearls, the value of which was probably not more than 6,000 pesos. Some very beautiful pearls are to be found in the Sulu fisheries, and it was my pleasure to examine two of these, each valued at 5,000 pesos, secured from this region during the past year.

Almost all the fishing for pearl oysters is carried on by the use of diving armor, in water of from 15 to 20 fathoms. Shells are occasionally found in shallower water, but in such cases naked Moros usually dive for them, or they are secured by a primitive rake-dredge worked by a rattan line from a native canoe and which can be used only in smooth water. The natives frequently soak dry shell in water for several days before it is sold, in order to increase the weight; and I have seen Chinese and other middlemen doing the same thing. The shells are usually opened on the boats and all the pearls extracted soon after the oysters are brought up.

THE PEARLING FLEET.³

At present about 30 vessels are engaged in pearling in the Sulu Archipelago. These boats range from 5 to 15 tons, and usually carry a crew of seven men, including the diver. All boats with armored divers

³The following boats constituted the Zamboanga pearling fleet for the year 1908: *Sirena* and *Nautilus*, owned by J. F. Maddy; *Cicopatra*, *Galatea*, and *Maritima*, owned by J. Wilson; *Ioenix* and *Placido Reyes*, owned by the Cebu Pearling Company; *Mina*, *Burtandy*, *Ida*, and *Manny*, owned by Capt. Chas. Linberg; *Paragua*, *Zamboanga*, and *Sapit*, owned by G. W. Langford; *Alice Holmes*, *Rosario*, and *Olinga*, owned by Mr. Holmes; *Mindanao*, owned by Mr. Teck; *Pruno*, owned by V. Sision. All of these boats carried on more or less active operations during the past year.

The Jolo pearling fleet is composed of the following boats: *Victoria*, *Helena*, *Santa Maria*, and *Elisabet*, owned by Ong Tiam Teng; *Almosouth*, owned by Hadji Abubacal; *King of Spades*, owned by Richard H. Gibbs; *Ramon*, owned by Hermandes & Co.; and *Alfonso* and *Nena*, owned by Asing.

are required to take out a license, for which the charges are 300 pesos a year for a first-class license, or a three months' license may be secured for one-fourth of this amount. These are obtained from the provincial treasurer at Jolo, Zamboanga, or Davao. The divers are usually natives or Japanese. Each boat is equipped with one complete diving outfit, consisting of armor, pump, tubes, weights, etc. The diver receives a wage of from 20 to 80 pesos per month, in addition to a percentage of the shell, but the terms upon which both men and divers are hired vary with almost every pearler.

The treasurer of Davao reports that nine first-class licenses have been taken out at that place since January, 1908, chiefly by local firms, and for the purpose of working the newly opened Davao pearl bed.

It costs about 55 pesos a month, aside from wages, to navigate a pearling boat. The diving armor used is nearly all of a modern type, and of English manufacture. The air pumps used are worked by hand, two men being stationed constantly at the pump when diving is in progress. The diver has from 18 to 20.4 kilos (40 to 50 pounds) of weight attached to him in order to reach the bottom. Divers usually remain under water until they fill the net basket which they carry, this requiring from ten minutes to an hour. The diver of a boat on which I was a guest for some time, usually made about three descents in one hour; this was on the Davao bank in a depth of 20 fathoms and where the man experienced great difficulty in working because of strong currents. The length of time during which an armored diver can remain under water is very indefinite, depending on the depth of water, strength of current, strength of the diver, and other factors. In calm water, but a few feet in depth and of an even temperature, a man should be able to remain for almost an indefinite period. The naked diver scarcely ever stays down for more than one minute. Fishing is carried on at all seasons of the year.

THE PHILIPPINE PEARLING BANKS.

Practically the entire region from Sibutu Passage to Basilan Straits and around the southern shore of Mindanao Island is a continuous potential pearling bank. However, the greater number of the known localities have so constantly been fished that they have had small chance to recover, and, as a result, much of the pearlers' time is lost in prospecting for new beds in various parts of this wide area; but the ground never seems to become completely exhausted, for we found pearling boats operating successfully directly in front of the town of Jolo, within half a mile of the beach. Fishing for shell had doubtless been carried on at this point for over a hundred years.

Occasionally, a pearler will locate a bank on which the oysters are

very abundant. Such a bank was found just south of Basilan Island; another near the Tapu Islands, and another in Tataan Pass of Tawi-Tawi Island. A large yield of shell has been secured near the Samales group. Shell has been reported from Illana Bay, and during the past year an extremely valuable bank was located in the Gulf of Davao in Pakiputan Strait between Samal Island and the mainland. The most prolific portion of the bank was in the narrow part of the passage directly between Point Lanang and Point Linao. The depth of water is from 20 to 25 fathoms. The bank is well protected above by the large reef known as Arboles Island. Usually, there is a very strong current pouring through this strait, but at the point where the pearl bank occurs the tides and currents form a strong eddy which has doubtless contributed to the formation of the bank by giving an opportunity for the spat to settle and attach. The bottom is of coral, sand, and gravel, and is comparatively smooth. The width of the strait at this place is less than 1.6 kilometer (1 mile); the beach on one side slopes steeply down, and on the other drops abruptly into several fathoms of water from a live coral reef. The water is quite clear, its temperature about 21° C., and its specific gravity 1.022. At the time of my visit (May, 1908), there were only four pearling boats operating on this bank; two others were prospecting in adjacent waters.

The currents were so swift that diving could be carried on only between the hours of 6 and 7 o'clock in the morning. The diver, a Filipino, during this hour made three trips to the bottom; on the first he secured three shells; on the second, eight; and on the third, two. These were all large, first-class shells, each weighing about 3.2 kilos (7 pounds). One contained a small pearl.

The diver brought up some young shells for our inspection, and reported that they were abundant on the bed. All the large oysters were in a breeding condition, so probably this bank will be able to keep up a moderate yield, unless overfished at the beginning. So far, the Davao pearl bank has yielded about 56 tons of first-class shell.

Pearl shells in considerable numbers are found in Tañon Strait, between Cebu and Negros Islands; in the vicinity of Guimaras; and also along the west and the north coast of Samar. Shell has also been reported from Palawan and Cagayan Sulu. It is more probable that as the Islands become better known, many new pearling banks will be found, and those now known will be mapped and better defined.

The most desirable bottom for a pearl bank is coarse sand, with dead coral and rock to which the young may attach. They can not grow on live coral, and they are very apt to be covered up and smothered on fine sand.

LIFE HISTORY OF THE PEARL OYSTER.

The oysters are of separate sex, male and female. The eggs of the female, when ripe, are extruded into the sea water, where they are fertilized by the spermatozoa of the male, if by chance the currents bring the two elements together. Doctor Hornell⁵ observed in regard to the Ceylon pearl oyster, "that a ripe female, in close proximity to a mature male, was sufficient cause to excite the male to throw off spermatozoa." The meeting of the spermatozoa and ova is left entirely to chance.

The eggs of the Philippine pearl oyster (*M. maxima* Jamson) are at first pyriform (see fig. 1) and float on the water; as soon as they are

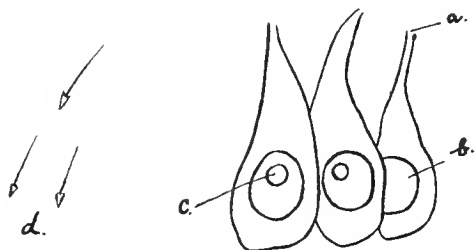

FIG. 1.—Spermatozoa and ova of Philippine pearl oyster.

- (a) Micropyle through which the spermatozoa enters the ova.
- (b) Nucleus.
- (c) Nucleolus.
- (d) Spermatozoa of male.

fertilized, they become round; and when from three to six hours old, they move about by means of small, hair-like cilia. Segmentation is complete, but unequal. The shell begins to form at the end of the second day, and in from four to eight days the young oysters settle and become attached to the bottom, or to any object they chance to fall upon. At this stage they are known as spat and

are about 1 millimeter (0.04 inch) in length. They attach by means of a small tuft of coarse, hair-like bristles, known as the byssus.

Each mature female contains several thousand eggs, but no doubt the destruction of eggs and young is very great, many being swept into great depths by strong currents, where they either perish or settle on the bottom so thickly as to smother each other; or else they become covered with sand, or attach to some floating object and are washed ashore. Apparently, there is no fixed time in the Philippines for the maturing of the ova, as sexually ripe individuals are found at all seasons of the year.

The shells are supposed to reach a maximum size and are most valuable commercially in from four to five years, although they doubtless continue to grow for several years longer. I have examined specimens weighing 5 kilos (11 pounds) which I believe were ten to twelve years old. However, shells older than five or six years are apt to be worm-eaten or full of holes caused by boring sponges, and so are of less value. More

⁵ Report on the operations of the Ceylon pearl banks during the fishery of 1905. *Rep. Ceylon Marine Biol. Lab.* (1906), 55.

accurate information regarding the age and growth of shells obtained from direct observations and measurements is very desirable.

Mr. Seville Kent states in regard to the rate of growth of the pearl oyster:

Under favorable conditions a period not exceeding three years suffices for the shell to attain to the marketable size of 200 to 230 millimeters (8 or 9 inches) in diameter, and heavy shells of 2.3 kilos (5 pounds) weight per pair may be the product of five years growth.

The food of the pearl oyster consists of minute marine infusoria, *Diatomaceæ*, etc. We discovered that in fully 75 per cent of the specimens examined, the food consisted of *Diatomaceæ* with a small amount of vegetable matter.

The pearl oyster does not travel to any great distance; in fact, after the spat stage, it remains in one spot for the greater part of its life, although it can, and does at times, cast off the byssus attachment and reattach to some more desirable place, moving very slowly by means of its small foot. The very old shells of *M. maxima* Jamson were, with but few exceptions, without attachment, probably the weight of the shell being sufficient to keep them in place.

ENEMIES OF THE PEARL OYSTER.

The pearl oyster, especially in its younger stages, is exposed, to constant danger. Numerous fishes consider it a great delicacy, and such fish are found in large numbers about the pearl banks. The various species of sharks, rays, sparoides, and balistes feed largely upon shell fish, including the pearl oyster. However, these are not wholly an evil, as they are probably the intermediate host for the cestode which is the cause of the growth of pearls; the fish becoming infested with this cestode by eating the oyster. Doubtless, star fishes also cause much destruction to the banks, and, in old specimens, the boring sponges, boring worms, and gastropods, do great damage.

In addition to these enemies which affect the oyster directly, there are an enormous number of marine animals and plants that, by using up the available space and food which otherwise would fall to the lot of the pearl oyster, affect the life of the oyster indirectly.

One pearl diver reported the finding of a very large pearl bank south of Basilan Island, where the shells were abundant and of very large size, but of no value, as they were dead and had lost their luster. In cases of this kind, it is almost impossible to state the cause of the destruction. It may have been brought about by some epidemic due to the crowded condition of the shells, or possibly by some volcanic disturbance, or a dozen other causes might be assigned, but without facts it is useless to theorize on the subject.

TRANSPLANTING AND CULTIVATING THE PEARL OYSTER.

Pearl oysters may with but little difficulty be transported for several days, if they are kept in running salt water, or if the water is changed frequently; thus the question of transplanting them from one bed to another in a more convenient locality, or in water of less depth, becomes a comparatively simple one and will doubtless play an important part in the pearl oyster industry of the future.

As a matter of fact, the Ceylon government is, or was at a recent date, engaged extensively in the transplanting of young oysters and the distributing of "clutch," i. e., rock of small size which is scattered over the bottom of the oyster beds, and to which the young oysters become attached. The young pearl oysters are removed from beds which are overcrowded to others which are less productive.

It would be an easy matter for men engaged in pearling to keep suspended over the side of their vessels bamboo crates or cars in which they could place the young oysters which are frequently brought up, and so transport them to a favorable place for development, as is the case in the sponge fisheries.⁶ In this way they might, with but little effort, accumulate a valuable pearl farm where a number of oysters could be harvested each year and the bed looked after just as in the case of the edible oyster. The yield of pearls and shell would doubtless pay a good dividend. This process would especially be easy to carry out in the Davao fisheries which are near shore and where local people are engaged in the fishing. Such farms should simulate the natural beds so far as practicable, but improvements over natural conditions could be effected by supplying an abundance of small, broken rock as "clutch," upon which the young could attach; the keeping of the beds free from undesirable tenants, such as star fish, holothurians, etc., could be accomplished by dredging.

LAWS RELATING TO PEARL FISHING.

I have abstracted the laws,⁷ or at least such portions of them not repealed by amendments, as are now in force in the Islands.⁸ They are of undoubted benefit in protecting the young shells, and, for the greater part, relate to the waters of the Moro Province. In other portions of the Archipelago, various local acts and provincial legislation greatly handicap the pearling industry.

⁶ *This Journal*, Sec. A (1909), 4, 62, 63.

⁷ These laws were enacted by the legislative council of the Moro Province. A copy of them may be secured from the provincial treasurer of either Jolo or Zamboanga.

⁸ Sec. 23, Act No. 51, of the Philippine Commission should read: "The words 'pearl shell and shell of the pearl oyster as used in Act No. 43 of the Legislative Council and in this Act shall be construed to mean the shell of the marine bivalve mollusk *Margaritifera maxima* Jamson, commonly known as the Philippine gold lip pearl oyster.'"

The laws should be extended to include the entire Archipelago, and all local regulations should be repealed. In this way only can the young shell properly be protected. Additional legislation protecting the black lip pearl shell, *Margaritifera margaritifera* (Linnæus), should be enacted.

Act No. 43 provides for the protection of pearl fisheries within the jurisdiction of the Moro Province, and was passed February 29, 1904. It forbids the taking of pearl oysters less than 100 millimeters (4 inches) in diameter.

Act No. 51 regulates the fishing for shells of marine mollusks and was enacted June 7, 1907, at the urgent request of the pearl fishers. It prohibits from engaging in pearl fishing all vessels not built in the Philippine Islands or in the United States, or not wholly owned by citizens of the United States or by people having the political rights of the natives of the Philippine Islands. It prescribes the places at which licenses to engage in pearl fishing may be secured, the price for such licenses, and the length of time for which they are granted. It states that the master of every vessel operating under a first-class license shall record the date of every operation and the number of shells taken each day. Before any shell can be landed, these records must be verified under oath in the presence of the collector of customs of Jolo or Zamboanga. This Act also amends Act No. 43 and requires the size of the shell to be 180 millimeters (7 inches) in diameter from the outer margin to the middle of the hinge, measured at a right angle to the hinge. A fine of not less than 50 pesos is provided for the violation of any provisions of this Act.

Act No. 131 amends Act No. 51 by reducing the price of first-class shell licenses to 300 pesos per annum, and provides for the issuance of such licenses for periods of three months. The enforcement of Act No. 51 resulted in such a decrease of revenues, owing to the excessive cost of licenses, that this amendment was made necessary, and it was enacted August 22, 1905.

Act No. 176 amends section 2 of Act No. 51 and was enacted October 12, 1906. It provides for the issuance of licenses only to those vessels wholly owned by citizens of the United States, to honorably discharged soldiers or sailors of the United States Army and Navy, to natives of the Philippine Islands, or to those having the political rights of natives.

Act No. 200 repeals Act No. 176 and was enacted September 19, 1907, and approved by the Philippine Commission October 7, 1907.

PEARLS.

The Philippine fisheries give a fair yield of pearls; in fact, some of the most beautiful specimens ever discovered have come from the Sulu fishery. The yield is fully as large as that in either the Gambier Islands or the Pearl Islands. The number of pearls secured in Ceylon is much greater. In that country the commercial pearl oyster is of a different species (*Margaritifera vulgaris* Schum.), a very small oyster prolific in pearls, but with shells of practically no value.

The composition of a pure pearl as given by Harley and Harley⁹ is as follows:

Carbonate of lime	91.72
Organic matter	5.94
Water	2.23
Loss	0.11

⁹ The Chemical Composition of Pearls. *Proc. Roy. Soc. London* (1888), 43, 461.

and that of the Ceylon mother-of-pearl, as given by Herdman and Hornell¹⁰ is—

Calcium carbonate	88.79
Calcium sulphate	4.93
Organic matter	2.32
Water	2.28
Loss (no magnesium, no phosphates, faint trace of iron)	1.68

It is well known that the organic basis of the shell, conchiolin, is a cuticular product excreted by the underlying epidermis of the mantle.

Passing without comment the many fanciful theories regarding the formation of pearls which have been held from historic times up to a comparatively recent date, we will consider only such facts as have been revealed by modern scientific investigation.

I have in my work dissected a large number of pearls from our large gold lip pearl oyster (*M. maxima* Jamson). Of this number, forty were prepared as "hard sections," each side being ground down so that a small transparent section through the center of the nucleus was obtained for microscopic examination. (See Plate V, figs. 1 to 3.) Ten were prepared as microtomic sections, and the remainder, and by far the greatest number, were dissolved in acids of various kinds and dissected.



FIG. 2.—Cestode from center of a Philippine pearl.

The results show that the round orient Philippine pearl may have various objects in the center forming the so-called nuclei, which, because of stimulation or irritation, have become incased in nacre, thus forming pearls. Fully 50 per cent of the pearls examined contained larval cestodes, two only contained sand, one a bit of seaweed, one a spicule of calcareous sponge, two, forms which with but little doubt were larval Distomids. One rather interesting form (see fig. 2) obtained from a perfectly round pearl appears very closely to resemble the free-swimming larval cestodes secured by Mr. Hornell in Ceylon,¹¹ and is doubtless a related form. Several pearls contained

material that had become calcified and could not be identified with any degree of certainty. Three had what I believe to be the ova of the small

¹⁰ Report of the government of Ceylon on the pearl fisheries of the Gulf of Manaar. *Roy. Soc. London* (1906), Part V, 6.

¹¹ Hornell & Shipley. Reports on Parasites of the Pearl Oyster. *Rep. Ceylon Pearl Fishery* (1903-1906), Part II, 77; Part III, 49; Part V, 43.

crab (*Alpheus avarus* Fabricius) which is almost without exception found living in pearl oysters as a commensal.

Pearls may be found in any part of the oyster, or in the shell. The free pearls and those attached to the shell result from some injury, while those in the muscles are formed around small, calcareous bodies called calcospherules. The so-called "blisters" on the inside of the pearl shell are usually produced by boring worms or by some external injury. How-

ever, in one case at least, a very fine blister now in my possession was caused by a small black pebble which was completely embedded in the shell. Blisters frequently contain pearls of value, and specimens of good shape and luster may become fully embedded in the shell. I now have a shell before me which, when found, exhibited no sign of a pearl, but when broken, showed two fine pearls, embedded and completely hidden in the shell. (For similar examples see figs. 3 and 4.)



FIG. 3.

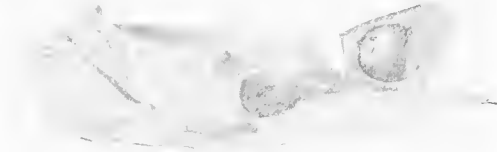

FIG. 4.

A bit of shell in which a pearl valued at 500 pesos was hidden. The X, fig. 3, shows where the pearl was located. Fig. 4 is the same shell cracked open, showing the pearl.

Cyst pearls are found in the mantle or soft parts of the oyster. These are formed by a larva, usually a cestode, which enters some portion of the connective tissue where, as stated by Doctor Jamson,¹² it at first occupies a space lined with connective tissue fiber; but the oyster soon gives rise to a pearl-secreting, epithelial layer which lines this space and becomes the pearl sac. I am of the opinion held by Mr. Herdman and Mr. Hornell¹³ that this pearl-secreting epithelium is of ectodermal origin.

ARTIFICIAL PRODUCTION OF PEARLS.

From the time of Linnæus, who claimed to have discovered a method whereby the oyster could be made to produce pearls, up to the present date, the attempt to force the passive oyster into producing culture pearls has never ceased, so that almost each year some one announces in the press of the country that he has at last reached the true solution of the problem and can produce pearls at will. There is no question but that,

¹² The Formation of Pearls in European Mussels by Action of Trematodes. *Proc. Zool. Soc. London* (1902), 140.

¹³ Notes on Pearl Formation in the Ceylon Pearl Oyster. *Rep. Brit. Assoc.* (1903), 695.

in some cases at least, cultural pearls have been produced; but when the methods have been brought to the crucial test there is always some small point or flaw which has prevented their application with profitable results. This is at least true concerning the forming of the free, round, cyst pearls of fine luster, but in so far as the production of half-pearls and blisters is concerned, the Mikimoto pearl farm in the Bay of Ago, Japan, need only be visited to carry conviction that the artificial production of pearls is both practicable and profitable, for at this place several hundred people are employed in the work, and the cultural pearls harvested find a ready market at a good price. In fact some of the "antique" jewelry sold in Manila was found to be set with these. (See photograph of some of these culture pearls, natural size, Plate VI, fig. 1.)

From 200,000 to 300,000 oysters are treated each year at this pearl farm. The method employed is similar in most respects to that used by the Chinese hundreds of years ago, when small, rough images of Buddha were placed between the mantle and shell of the live river clam, which was then returned to the water until the images were coated over with nacre, after which they were taken out and sold as charms. The Japanese use a small canula to insert a minute mother-of-pearl bead which is flat on the side and which fits against the shell. The oyster is then again placed in the water and allowed to grow for six or seven years, when the pearls are harvested. The undertaking is profitable, owing to the large number of oysters treated.

However, the chief object to be desired is to grow round, perfect, cultural pearls of fine luster; in other words, to produce a cyst pearl, or one so closely resembling it as to be indistinguishable from it. Our efforts have been directed to this end, but the results so far obtained do not warrant publication. As an illustration of some of the difficulties encountered by those engaged in experimenting in pearl growing, a gentleman from Australia, who some time ago purchased the experimental pearl farm inaugurated at Tuesday Island by Seville Kent, and who had spent several thousand pounds in attempting to grow cultural pearls, remarked to me, "I have succeeded in growing the perfectly round pearls, but my great difficulty is to prevent their discoloration."

It may be predicted that within the next few years perfectly round cultural pearls of fine luster will be produced commercially and that the undertaking will prove to be the most profitable achievement of modern zoölogy.

Pearls of value sometimes are found in other mollusks of the Philippines, as, for instance, in the Taclobo (*Tridacna gigas* Linn.) which occasionally contains pearls of great beauty. (See Plate VI, fig. 2.) However, these usually are without luster and hence valueless.

DETERMINATION AND VALUATION OF PEARLS.

Pearls have a hardness of 4, they are so compact that they do not break when stepped upon; their specific gravity is 2.65 to 2.68. To be of much value they must be round or drop-shaped and either pure white, or dark, or of a golden color, with a peculiar luster and slight translucency. They must be free from spot, speck, or blemish. As they are formed, layer upon layer, around a central point, like the layers of an onion, they are sometimes peeled or "doctored" to remove spots or flaws, in the hope that the new layer will be of better luster. Such pearls are obviously of much less value than those found perfect, in their natural condition. However, any such tampering with a pearl can usually be detected by the use of a good glass, which shows any minute band-like stripes or slight scratches. It is also a very easy matter to detect whether a trifle more than one layer of a pearl has been taken off, and equally as easy to tell the difference between a pearl that has been ground into a round shape and one naturally round; such specimens are of but little greater value than marbles. The following is a table of the actual size of pearls of from 0.1296 to 1.944 grams (2 to 30 grains).























Grains.		Grains.		Carats.
2		3		$\frac{1}{2}$
4		5		$\frac{2}{3}$
6		7		1
8		9		$\frac{1}{4}$
10		11		$\frac{5}{8}$
13		14		2
15		16		$2\frac{1}{4}$
17		18		$2\frac{1}{2}$
20		22		3
25		30		4

FIG. 5.—Exact sizes of pearls from 2 to 30 grains in weight.

No one but an experienced buyer can properly estimate the value of a pearl, as many conditions, such as size, shape, luster, flaws, etc., must be taken into consideration. In 1896 a very interesting publication was issued by the United States Government,¹⁴ giving the value of pearls all over the world, together with an estimate of the yield. In Manila, a perfect pearl of 0.0643 gram (1 grain) with good luster and shape retails for about 5 pesos. The price increases more rapidly than the size of the pearl, as from 70 to 100 pesos per 0.205 gram (1 carat) is asked for perfect pearls over 0.41 gram (2 carats) in weight.

¹⁴ Pearl Fisheries and Pearl Supply. *U. S. Consular Report*. (1896), 51, 622.

ILLUSTRATIONS.

PLATE I.

Landing pearl shell at Jolo.

PLATE II.

- FIG. 1. Jolo pearling fleet.
2. Pearl diver in the water.
3. Pearl diver coming out of the water.

PLATE III.

Philippine gold lip pearl shell (*Margaritifera maxima* Jamson).

- FIG. 1. Inside view.
2. Outside view.

PLATE IV.

Philippine black lip pearl shell (*Margaritifera margaritifera* Linnæus).

- FIG. 1. Inside view.
2. Outside view.

PLATE V.

- FIG. 1. Section through center of Philippine pearl, showing an encysted cestode.
2. Section through a Philippine pearl, showing a calcified cestode in the center.
3. Section through a Philippine pearl which had a grain of sand in the center. It is also shown how a perfectly round pearl may become irregular and how it may be peeled to form a perfectly round pearl.

PLATE VI.

- FIG. 1. Culture pearls from the pearl farm in the Bay of Ago, Japan.
2. Pearls, found at Siasi Island in Tacloban shells.

TEXT FIGURES.

- FIG. 1. Spermatozoa and ova of Philippine pearl oyster.
(a) Micropyle, through which the spermatozoa enters the ova.
(b) Nucleus.
(c) Nucleolus.
(d) Spermatozoa of male.
2. Cestode from center of a Philippine pearl.
3. A bit of shell in which a pearl valued at 500 pesos was hidden. The *x* indicates the spot where the pearl was hidden.
4. The same shell as in fig. 3, but cracked open showing the pearl.
5. Exact sizes of pearls from 0.1296 to 1.944 grams (2 to 30 grains) in weight.



LANDING PEARL SHELL AT JOLO.
PLATE I.



FIG. 1.

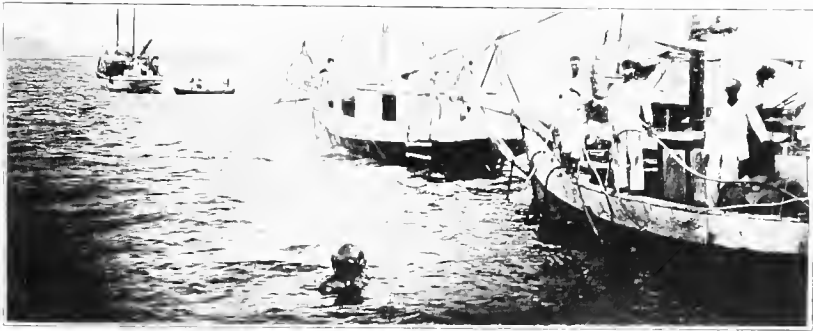

FIG. 2.

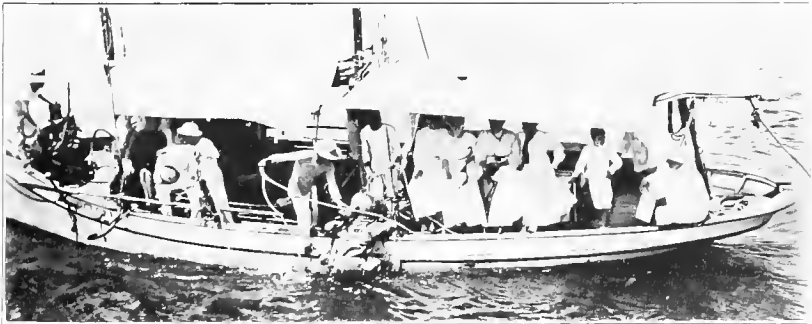

FIG. 3.



FIG. 2.

FIG. 1. PHILIPPINE GOLD LIP PEARL SHELL (*MARGARITIFERA MAXIMA JAMSON*).

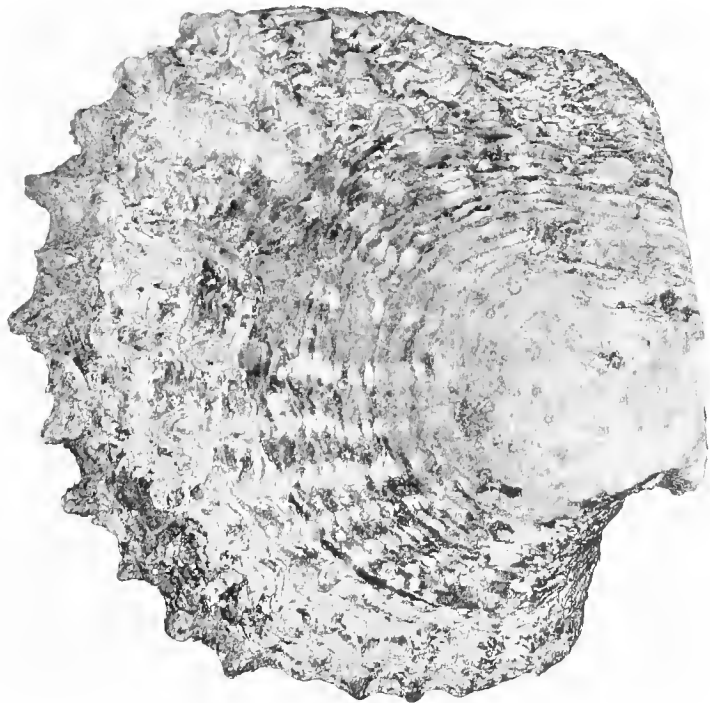

FIG. 2.

FIG. 1. PHILIPPINE BLACK LIP PEARL SHELL (*MARGARITIFERA MARGARITIFERA* LINNEUS).

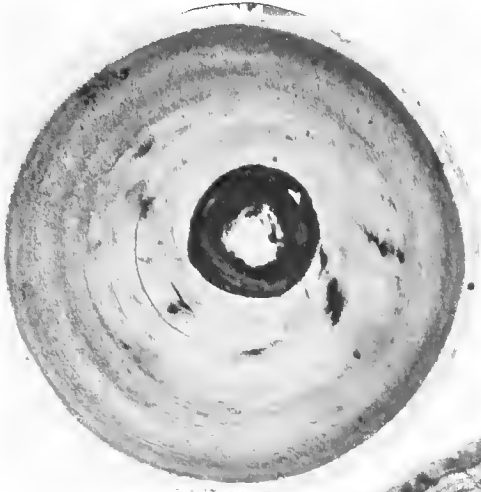

FIG. 1

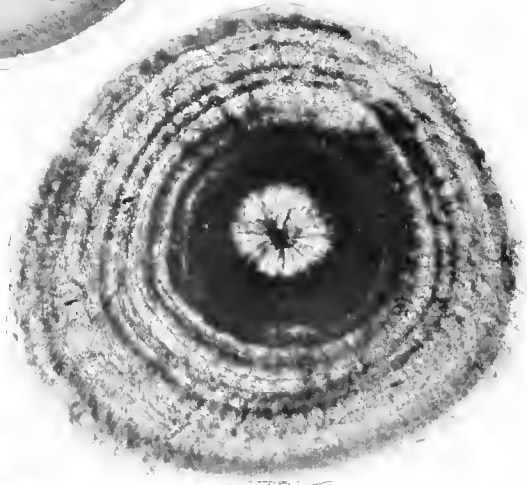

FIG. 2.



FIG. 3.

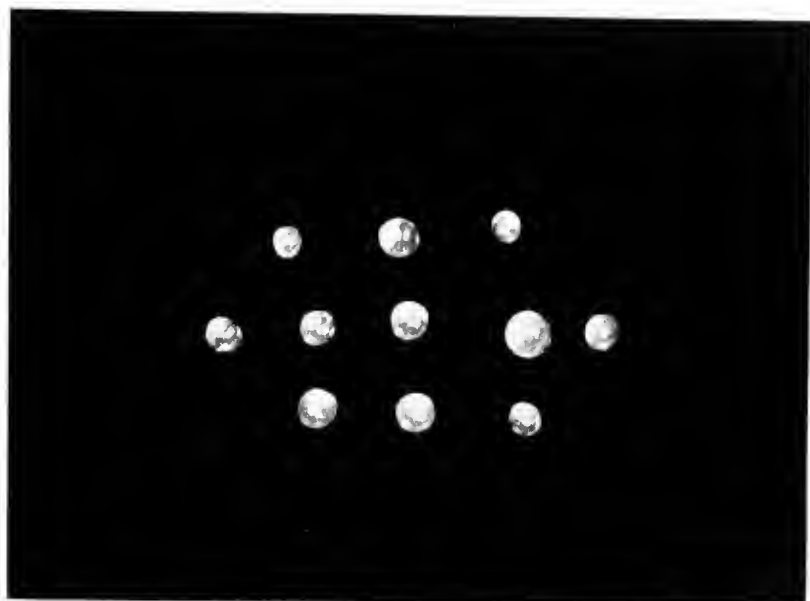

FIG. 1

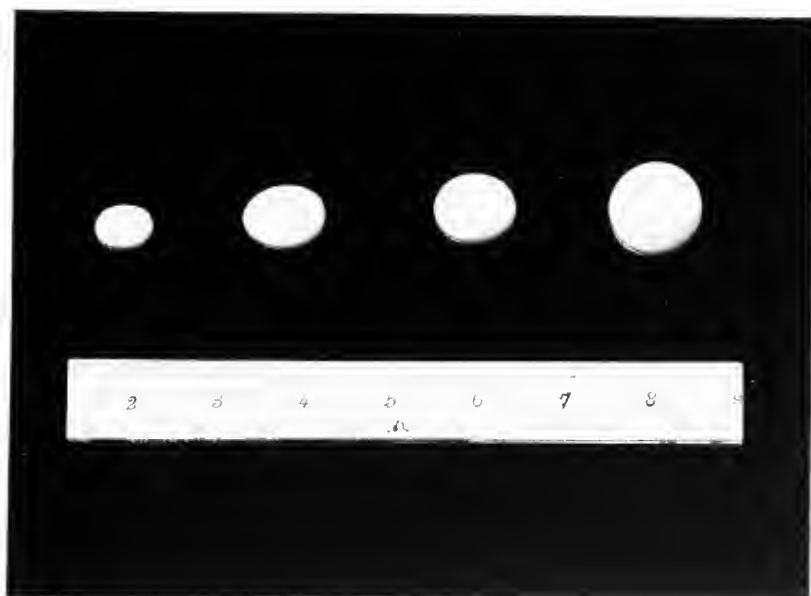

FIG. 2.

THE PHILIPPINE
JOURNAL OF SCIENCE

D. GENERAL BIOLOGY, ETHNOLOGY
AND ANTHROPOLOGY

VOL. VI

DECEMBER, 1911

No. 6

THE FISHERY RESOURCES OF THE PHILIPPINE ISLANDS.
PART IV, MISCELLANEOUS MARINE PRODUCTS.

BY ALVIN SEALE.

(From the Ichthyological Section, Biological Laboratory, Bureau of Science,
Manila, P. I.)

CONTENTS.

- I. Trepang (*Bêche de Mer*).
- II. The Shark-fin Industry.
- III. Philippine Sea Turtles and Tortoise-Shell.
- IV. The Philippine Window Shell.
- V. Philippine Shells Used in the Manufacturing of Buttons.
- VI. Precious Corals.
- VII. Edible Seaweeds of the Philippines.
- VIII. The Preparation of Isinglass in the Philippines.
- IX. Preparing Skins of Aquatic Animals for Leather.
- X. A Check-list of Philippine Holothurians.

I. PHILIPPINE TREPANG (BÊCHE DE MER).

Trepang is a general name applied in the Philippines to all of the many species of animals belonging to the group Holothurioidea and known locally as *bêche de mer*, *balatan*, *bilate*, *munang*, *hisam*, sea cucumber, and cotton-spinner. Large quantities of these animals are gathered in the Philippines for export to China and Japan. Trepang is a staple food of all Oriental people and is an important item of export from the Philippine Islands.

Trepang in general appearance resembles pickled cucumbers. The

skin may be smooth, or covered with prickle-like teats arranged in rows or scattered over the body. In color they range from pale flesh-color to black. These animals, when dry, are hard, sausage-shaped, and appear to be altogether unpalatable and it is not until they have been cleaned, minced, and made into a most delicious soup by the skillful hand of the Chinese cook that the real value of this product of the sea is understood. *Bêche de mer* live among the white sand and coral in the sea-gardens and feed upon small sea-animals and sea-vegetation, so there is no reason why they should not rank as a delicious food product and come into general use among Europeans and Americans. I can, from experience, heartily recommend a trial of trepang soup¹ to those who delight in a dish free from the contaminations of the land, with a delicate aroma of the deep sea about it.

VARIETIES OF PHILIPPINE TREPANG.

In Manila all the large dealers in trepang are Chinese. They recognize five different varieties, as follows:

*No. 1.*²—*Oë* (Plate I, fig. 1). A large, uniformly black, perfectly smooth variety (*H. atra* Jæger). This species, when dry, is from 120 to 200 millimeters in length and 40 to 60 millimeters in diameter. This is regarded as the most desirable species found in the Islands and sells for the highest price, being valued at 65 to 98 centavos per kilogram wholesale, according to the size of the animal, and care in curing. I will call it the great smooth black trepang.

No. 2.—*Gan Sim* (Plate I, fig. 2), is a large brownish trepang, with two rows of teats on each side. The animal, when dry, is of a rather flat, oval shape, about 120 millimeters in length and 60 millimeters in width. Its back is but slightly roughened. This species is regarded as being next to the best variety, sells for 40 to 80 centavos per kilogram, and is in fair demand. We will call it the great oval brown trepang.

No. 3.—*Bark Sim* (Plate I, fig. 3) is the third grade of trepang and to this belongs the great mass of trepang shipped from the Islands. It includes a large variety of forms ranging in price from 35 to 70 centavos

¹ *To make trepang soup.*—Clean and wash out the trepang in cold water, slice and put them in a chopping bowl and mince fine, soak in cold water five hours, then boil for one hour, add salt and pepper and a quantity of beef or chicken stock and bring to a boil. Serve hot. [Sing Fat.]

² I have been unable to find anyone in the Philippines who recognized or could give me any information regarding the names given to the Philippine trepang by Simmonds in his *Commercial Products of the Sea*, although I have repeatedly asked dealers and fishermen both in Jolo and Manila. It is possible that his so-called "bankolungen" is the gan sim, his "munang" the oë, his "telepan" the moi whar che, his "sapatos grande" the smooth white ringed bark sim, his "sapatos china" is perhaps the great convoluted bark sim, and his "lowalowan" is possibly the bark sim, called the small black wrinkled trepang in the present paper.

per kilogram, the most abundant, perhaps, being small, black, slightly roughened, cylindrical in shape, and when dry about 90 millimeters long by 25 millimeters wide (Plate II, fig. 1). Another very common form of this grade is the Philippine convoluted trepang, a large, light brown species about 130 millimeters by 40 millimeters, cylindrical, with the body, when dry, thrown into deep folds (See Plate II, fig. 5). Another bark sim is a moderately roughened, cylindrical trepang of a dull yellowish-brown color and 150 by 35 millimeters in size (Plate II, fig. 3). Another is a dark brown, almost smooth form (when dry), with the back covered with small orange spots with black centers. This is a large species, 170 by 70 millimeters, and cylindrical in shape (Plate 4, fig. 4). I will call this the smooth white-ringed trepang. Another form very similar to the last I will term the rough white-ringed trepang. (Plate II, fig. 2.) This trepang is 160 by 48 millimeters in size, cylindrical, with the body decidedly tuberculate; it is rather dark brown in color with numerous white circles around the large tubercles of the sides and back. Another rather common trepang of the bark sim grade, is a small, very black form, with deep wrinkles in the body (Plate II, fig. 6). This variety when dry is cylindrical in shape and about 80 millimeters long by 20 millimeters deep. I will call it the small black-wrinkled trepang.

No. 4.—Moi Whar Che (Plate I, fig. 4). This trepang is a large, cylindrical black form, easily distinguished by the fact that the entire back is covered with numerous, very long teats which are black or reddish brown in color. This variety is quite abundant, but is regarded as fourth rate as a food product, the price being from 30 to 50 centavos per kilogram. I will term it the great prickly trepang.

No. 5.—Hong Che (Plate I, fig. 5) is the fifth grade of trepang, and resembles the last except that it is smaller and more cylindrical; the teats are more pointed and slightly longer. Its wholesale price is from 35 to 45 centavos per kilogram. Many of the young of the moi whar che are to be seen in this class, but are distinguished easily by their short teats. In size the hong che is from 50 to 90 millimeters in length by 16 to 20 millimeters in width.

There are numerous other grades among the 63 species of these animals found in the Philippines, but none are of sufficient importance or value to be recognized in trade. However, one very common form, called "yellow belly," is so abundant, especially about Mindoro, that it deserves at least to be catalogued. This form when dry is yellow-white on the belly and black on the back, about 60 millimeters in length and 25 in depth; its value is not above 12 pesos³ per picul. It is only the great abundance of this grade that makes it worth our consideration.

All of the above grades retail in Manila for fully 30 per cent advance on the prices obtained by the fisherman.

³ One peso is equal to 50 cents United States currency, and 1 picul is 139 pounds.

DISTRIBUTION, HABITS, GROWTH, AND PRODUCTION OF PHILIPPINE TREPANG.

The wide distribution of these apparently helpless, sedentary sea-animals is a matter of interest and astonishment to all who give the subject any thought. Twenty of the species found in the Philippines are also common to Polynesia, 16 to the Malay Archipelago, 30 to the Red Sea and the coast of Africa, while 3 extend even to the west coast of America. The majority of the recorded forms are believed to be well distributed throughout the Philippines, but are most abundant in the Sulu Archipelago. The supply for Manila comes chiefly from Tacloban, Polillo, and Ambos Camarines. They are found in water of various depths, even in very shallow water and also on reefs dry at high tide, down to 137 fathoms and even to much greater depth. Sheltered places inside the coral reefs where the bottom is of coral sand seem to be favorite haunts of the bark sim and hong che forms, while moi whar che, gan sim, and oê seem to prefer water of greater depth just at the edge of the reef. The greater number of the trepang appear to pass large quantities of sand and mud through their alimentary canals; from this sand they extract the small animals and plants on which they feed. On Arboles Reef, Gulf of Davao, Mindanao, I once noticed a large number of *Colochirus quadrangulus* Less. feeding on sea-weed which at low tide was about 75 millimeters (3 inches) under water. They were so abundant that it was scarcely possible to step without treading them down, and in one scoop of an ordinary dip net I secured 57 of them. It is probable that during the season for depositing the eggs they all seek the reefs or rocky crevices. Mitsukuri,⁴ in his most interesting paper on the common Japanese trepang, writes, referring to the Island of Oki,

The people there have for a hundred years or more been in the habit of putting up loose stone-piles in the shallow sea in order to obtain a supply of this trepang.

Nowhere in the Philippines is this device put into practice although it doubtless would yield profitable results.

Practically nothing is known about the breeding time of the Philippine trepang and it is a subject well worth investigating. In Japan (as abstracted from the above paper), the trepang spawn in May and June, and at the end of the first year have a maximum size of 5 by 25 centimeters. They reach the adult condition at the end of the second year, but do not spawn until the end of the third; some individuals probably live two or three years after spawning. The young specimens are white and transparent, and they attach themselves to the roots of algæ, or seek rocky crevices in sheltered localities. Hence a rock pile affords a natural collecting ground for the very young as well as for the old. Japan has put some measures in force setting aside certain localities as

⁴ Notes on the Habits and Life-History of *Stichopus japonicus* Selenka. *Annot. Zool. Jap.* (1903-06), 5, 1-21.

breeding reserves for trepang, upon which stone piles or dikes have been constructed, and in these places fishing for trepang is strictly forbidden. In this way the Japanese hope to conserve this valuable food supply.

There are so many natural breeding places in the Philippines along the coast and among the rocks on the shore line of the many islands, that our supply now is, and probably for years to come will be, much greater than the demand, or rather more than the fishermen under present conditions will take the trouble to dry and prepare for market.

METHODS OF FISHING FOR TREPANG.

In gathering trepang, the fisherman usually goes out at low tide wading in the shallow water, dragging a small canoe or *banca* behind him, into which he throws all the trepang he picks up; sometimes he fishes from a boat, with a long handled, one-pronged spear, with which he gathers up the trepang in water of 3 to 4 meters. In water of greater depth some fishermen dive and bring up the trepang in their hands. There are localities where small dredges undoubtedly could be used with good effect.

PREPARING TREPANG FOR MARKET.

The Filipino method of preparing trepang for the market is to boil them for a short time (from five to twenty minutes) in fresh water, after which they are split up the belly, eviscerated, and then thoroughly dried in the sun. Each variety seems to require a slightly special treatment particularly in regard to the length of time required for boiling, in order to bring out the best flavor. However, they should all be heated thoroughly throughout, and when taken out of the boiling water they should be hard and elastic, and should dry quickly like a hard boiled egg. The oê frequently is boiled only five minutes; it should be well stirred. Experience really is the only guide as to the length of time required for boiling. Sun-dried trepang are the best, and in the greatest demand, but the method of sun-drying is too slow for preparing a whole ship-load. The following method given by V. Simmonds^o is followed in preparing large shipments of trepang.

The first thing to do on arriving at an island where trepang is plentiful is to erect a curing house on shore. This house may be of any desired size but one 30 meters long by 15 meters wide, with sides 4 meters high, will be found convenient for preparing a ship's cargo. This structure may be built of native material such as mats, bamboo, etc., and roofed with a coconut thatch which must be put on well to keep out the rain. A small door should be left in each end of the house. Platforms for drying the trepang are then erected along one side of the entire length of the house and these should be 2 meters wide, the lower one about breast-high from the ground and the upper one 1 meter above that.

^o The Commercial Products of the Sea. New York (1897), 111.

These are made of split pieces of bamboo or small slats. A trench 1 meter in width and a half meter deep is then dug beneath the lower platform along its entire length, for the fires. Tubs filled with salt water are placed at short intervals along the trench, with buckets near at hand for use in preventing the fire blazing up and burning the trepang or destroying the house.

The process of curing is as follows: The trepang is first caught and gutted and washed in fresh water; it is then carried into the curing house and placed on the lower platform where it is spread out about 14 centimeters (5 inches) thick, to dry. When this platform is covered with the trepang, the fires are lighted in the trench; they must constantly be kept going, day and night, and be carefully guarded. Much skill is required in properly drying the trepang as well as in boiling it, as too much heat will cause it to blister and get porous, like a sponge, whereas too little will lead to its spoiling and turning putrid within twenty-four hours after being boiled; care is requisite likewise in gutting, for if this is not properly attended to the animals will turn into a blubbery mass within a few hours after being caught. On the afternoon of the second day after the fires are lighted, they are extinguished for a short time and the trepang is shifted to the upper platform; splints of wood should be put in those not properly drying. The lower platform is then filled again with a fresh supply of trepang from the pots, and the fires are again lighted. The trepang on the lower platform should be turned frequently during the first twelve hours. After another two days the fires are again put out and the trepang on the upper platform shoved over at one end to make room for those on the lower platform, and the same proceeding repeated for the two following days, by which time (six days in all) the first day's product will be cured properly. The trepang is then taken off the upper platform and carefully examined, those not dry are put back again, and the quantity cured is stowed away in bags on shipboard or in a dry storehouse. The product soon becomes damp unless packed in air-tight casks. If held in storage for three months, it requires to be dried again for a short time in the sun.

Forty men are necessary to work a house of the above size to its greatest capacity.

UTILIZING TREPANG AS FOOD.

The chief use of trepang as food is in the form of a savory soup, as heretofore described. It is also eaten as a meat by certain natives of the Philippines, after it has been roasted. In some islands of the Busuanga group, the natives collect these animals and by irritation cause them to eject a viscous white fluid which swells up greatly when it comes in contact with sea-water and splits into numerous white threads, not unlike cotton; these threads are cooked and eaten and are regarded as a delicacy. However, as the animal frequently ejects almost all the viscera as well as the mucus, the dish probably would not appeal to Europeans or Americans.

The Chinese believe that trepang is not only a most delicious food, but that it also possesses excellent medicinal qualities.

QUANTITY AND VALUE OF EXPORTED PHILIPPINE TREPANG.

Sixty-six thousand eight hundred thirty-eight kilograms of trepang were exported from the Philippines in 1909. The export in 1910 was 120,969 kilograms, which, at the low price for third grade quality, would

be valued at 51,780 pesos. As a matter of fact much of it was first and second grade trepang so that probably the true value would more nearly approximate 75,000 pesos. According to British statistics, the Sulu Archipelago alone supplied Singapore in 1907 with trepang valued at 21,975 pesos. Singapore's total trade in trepang for that period was valued at 442,102 pesos, two-thirds of which was shipped to Hongkong. It would be much cheaper for Hongkong to buy directly from Manila; as a matter of fact, our last year's increase in export largely was due to the direct buying of Hongkong dealers.

China imports each year about 3 million kilograms of trepang, chiefly from the Malay Archipelago, Philippine Islands, and the South Pacific Islands. The export from Manila might easily be doubled without damage to the fisheries.

COMMERCIAL POSSIBILITIES IN PHILIPPINE TREPANG.

While it is true that trepang is one of the minor marine products of the Philippines, nevertheless, we should not lose sight of the fact that it is a staple and recognized article of diet with a country which has the largest population on the face of the globe, and where it finds a ready market; also, that it can be cheaply prepared, that the natural supply in the Islands is large, and that with but little care the output probably could be increased readily. Taking all these facts into consideration, it is rather a matter of astonishment that large canning companies, especially in the United States, have not awakened to the possibility of this product of the sea and added the delicious trepang soup to their list of conserved products.

A check list of Philippine holothurians appears at the end of this paper.

II. THE SHARK-FIN INDUSTRY IN THE PHILIPPINE ISLANDS.

The drying and curing of sharks' fins (Plate III, fig. 1) in the Philippines, for export to China, is one of the minor industries, requiring but little capital and yielding profitable returns. At present the business is almost entirely in the hands of Chinese merchants.

The fins of all of the numerous species of sharks found in the Islands are used, as well as some of the fins of the larger rays. The big, dorsal fin of the shark is the most desirable; this is usually of a uniform pale grayish or whitish color on both sides, and is supposed by the Chinese to contain more gelatin than any of the others, therefore it commands the highest price and is known in commerce as the "white fin." All the remaining fins, which include the ventrals, pectorals, anal, and caudal, are classed together as "black fin." The large caudal fin, when uniform in color, is frequently put in as "white fin." The fine white fins are selected for the making of soup, while the black fins are largely used in manufacturing a superior grade of fish glue.

METHOD OF CATCHING SHARKS.

Sharks are principally caught by the Moros, although they are captured in considerable numbers in corrals and nets throughout the Islands. The Moros usually spear them, or catch them with hook and line, using stale fish for bait. The observer can not fail to be impressed by the number and size of the sharks caught by the Samal Moros in the vicinity of Sitanki Island.

A number of Philippine sharks will take the trolling spoon, especially if it is painted red on one side; they afford very good sport. In India, sharks are captured in large nets for the sake of the oil secured from the liver; they are also used as food by the poorer classes. In the Philippines the Moros alone seem to relish shark-meat, and the manufacture of fish oil is an entirely neglected industry. If we consider the great number of sharks caught in these Islands, it is a matter of surprise to find that the making of fish-oil is not carried on in connection with the shark-fin industry, as this would very materially increase the revenue derived from each shark.

THE PREPARATION OF SHARKS' FINS.

The fins are cut from the shark as soon as possible after its capture, the thick fleshy portions of the larger fins are slit open to facilitate their drying, and they are then spread out in the sun. It requires from three to six days to dry the product depending upon the amount of sunshine. After the fins are thoroughly dry they are assorted into two grades: The white fins, or first class variety, in which are placed all the large dorsal fins; and the black fins, or second class, which includes all the small fins. They are then packed tightly in bales of about 100 kilograms each and are ready for export.

These fins are further prepared by being soaked in boiling water for a short time and the skin removed. They are then shredded into small cartilaginous rods, somewhat resembling a very fine grade of spaghetti. These are waxy white and attractive in appearance (Plate III, fig. 2).

At this stage they are either made into soup, or dried and reexported to all parts of the world at considerably more than double the original price. To make this prepared fin into a savory and wholesome soup it is soaked in cold water one day, then placed in hot water for one hour, this causes all the rods to separate. Eggs and some chicken or beef stock, salt, pepper, and butter are added and the mixture boiled for two hours. That the above receipt produces a most delicious soup was the unanimous verdict of the staff of the Bureau of Science after testing a sample prepared by Sing Fat, a well known Chinese cook of Manila.

No great Chinese feast is complete without a dish of this soup and I believe it is worth while to call the attention of our large soup manufacturing establishments to the possibilities of this industry in the Philippines. I believe that an almost unlimited market could be found in China.

THE AMOUNT AND VALUE OF SHARK-FIN EXPORTED FROM THE PHILIPPINE ISLANDS.

Sharks' fins weighing 172,610 kilograms, valued at 85,000 pesos (42,500 dollars), were exported from Manila during the year 1910. The current price of shark-fin at Zamboanga, which is one of the centers of the trade,

is 84 centavos per kilogram for the white fin and 58 centavos for the black, therefore, it is evident that the export valuation is very low and that the real value probably would be somewhat over 100,000 pesos. The price is subject to considerable variation. In 1909 the maximum price paid for the entire yield was 2.19 pesos per kilogram including both white and black fins. Chinese merchants in Zamboanga informed me that the price for the first grade white fin sometimes reaches 6.58 pesos per kilogram, but this is unusual. Almost the entire yield of Philippine shark-fin is shipped to Singapore or Hongkong, and from these places is distributed to various parts of China.

In Manila the retail price of prepared shark-fin, as shown in Plate III, fig. 2, is from 8 to 10 pesos per kilogram.

In conclusion I wish again to call attention to the fact that the by-products of the shark fishery are entirely wasted. If, in addition to the fins, the liver was used to make fish oil, and the skin which is used for scabbards for swords was also saved, the revenue derived from each shark would be about doubled.

III. PHILIPPINE SEA TURTLES AND TORTOISE-SHELL.

VARIETIES OF PHILIPPINE MARINE TURTLES.

Sea turtles of large size find a congenial home in the warm waters of the Philippines. Abundant schools of fish supply them with plenty of food, and the hot sandy beaches of numerous, small, uninhabited islands furnish them ideal nesting places; hence, as a result of these conditions, the three recognized species of sea turtles are found throughout the Archipelago.

The marine turtles⁶ are easily distinguished from all other kinds by the fact that their limbs have become completely changed into paddles, the fingers being entirely encased in a single skin, with one or two claws only projecting. They swim swiftly in the sea, but are almost helpless on the land, and if turned on their backs they can not regain their normal position.

Our most important sea turtle, popularly known as the hawksbill turtle, is *Chelone imbricata* Linn. (Plate IV, figs. 3 and 4), which supplies the tortoise-shell of commerce. It is easily recognized by the fact that it has a hooked bill (Plate IV, fig. 4) and but 13 plates on the back, which overlap like the shingles on a roof; in addition, there are 25 small plates which form the margin of the back. This turtle feeds largely on fish, crabs, and mollusks, and when full-grown is about 1 meter in length.

⁶All members of the turtle family that live in the sea are called turtles; those living on the land only are termed tortoises; and those living in fresh water terrapins.

The green turtle (*Chelone mydas* Linn.) is next in importance. (Plate IV, fig. 5.) This turtle has a straight bill (Plate IV, fig. 6), but the shields on the back, while the same in number as in the hawkbill, are perfectly smooth, evenly joined, and do not at any stage overlap. This turtle is valued chiefly as food, the shell being of no value. However, as an article of food it has from time immemorial been considered a great delicacy. This species is herbivorous, and when adult it is about 1.25 meters in length. The flesh may be cooked in any desired way, either roasted, used as soup, fricasseed, or made into stews or pies. The following method of cooking the plastron, or shell of the belly, is given by Father Labat, a Dominican monk.⁷ It sounds so appetizing that I give it in full.

The plastron or buclker is the shell of the belly, on which is left three or four inches of flesh, with all the fat, this being green, and of a very delicate flavour. The plastron is placed in the oven. It is seasoned with lemon, capsicum or cayenne, salt, pepper, cloves, and eggs beaten up. The oven ought not to be too hot, as the flesh of the turtle being tender it should be cooked slowly. While it is baking the flesh must be pierced from time to time with a wooden skewer, so that the gravy may penetrate all parts. The shell is sent up to the table and the meat carved out from it. I have never eaten anything more appetizing or better flavoured.

There are large factories in various countries that can the soup made of this turtle.

The third variety of marine turtle found in the Philippines is the loggerhead (*Thalassochelys caretta* Linn.) (Plate IV, figs. 1 and 2). This species is easily distinguished from either of the above from the fact that it has 15 shields on the back and 27 around the margin of the shell. The jaw is strongly hooked (Plate IV, fig. 2). It feeds on crabs and other crustaceans. The shell is about 1.25 meters in length when full-grown. The shell practically is of no value, being almost as thin as paper (Plate V, fig. 4), and it is only used for veneering and inlaying work. The price for which it sells is from 2 to 4 pesos per kilogram. However, the animal supplies a large portion of the turtle oil of commerce.

TORTOISE-SHELL.

During the fiscal year 1909 there were exported from the Philippines 2,040 kilograms of tortoise-shell valued at 34,942 pesos. During the year 1910 the exportation fell to 1,191 kilograms, probably owing to home buying and domestic use.

The hard, bony plates which cover the back (carapace) of the hawkbill turtle are the tortoise-shell of commerce (Plate V, fig. 1). There are 13 of these plates on the back of each turtle, 5 in the center and

⁷ Simmonds, Commercial Products of the Sea. New York (1895), 367.

4 on each side. In commercial terms these are known as 8 "sides," 2 "hoofs," 1 "skull," and 2 "main" plates. The two middle side-plates are of the greatest value, being the largest and thickest. Plates 17 by 30 centimeters in diameter with a thickness of 5 to 6 millimeters are not unusual in the Philippines. In addition to these large plates, there are 25 small ones around the margin of the shell; these are known as "hoofs" and are of much less value. All of the plates together are known as a "head" of shell, and tortoise-shell nearly always is sold by the "head."

Practically all the Philippine tortoise-shell is brought into the market by native fishermen. Now, while a small number of these turtles is captured by fair means, with hook, net, spear, or trap, by far the greater number is taken when they come ashore to deposit their eggs. The fishermen are so eager to secure their prizes that as a rule they do not give the poor turtle a chance to deposit her eggs before they kill her. This short-sighted policy eventually will result in the destruction of the fisheries unless the turtles are protected during the breeding season, which is from May to August. The turtle fishermen go to small, uninhabited islands, frequently many miles from the large islands surrounding the Sulu Sea, and wait perhaps days for the turtles to come ashore to deposit their eggs. If the men are in no especial hurry they may wait until the turtle has deposited her eggs, which sometimes are 150 to 200 in number, and about the size of hens' eggs, with tough leathery shells. The fishermen then kill her before she can reach the water, and dig up the eggs which they use as food. The islands of Bancoran, Lumbucan, Arena, Cavilli, and others in the Sulu Sea, are well-known nesting places of the turtle, and it is only necessary to visit these islands to see the destruction wrought during the nesting period.

The best method of removing the tortoise-shell from the back of the turtle is to immerse the back in boiling water until the shell loosens; another method is to bury the body in the sand for eight days, when the shell becomes loosened; still another is to hold the shell over a slow fire until loosened. This latter process usually is employed. In some countries the live animal is held over the fire until the shell is loosened; it is then turned loose "to grow another shell." This method is barbarous, not only for its cruelty but also for its lack of utility, for the animal promptly dies.

WORKING AND WELDING TORTOISE-SHELL.

The methods employed in the working of tortoise-shell are quite similar to those used in working horn. As a matter of fact, horn frequently is used as an imitation of tortoise-shell. Slow heat or steam is employed, the shell becoming plastic by immersion in water of 90°C. for two minutes. When cool, it retains any shape given it while hot.

The exact technique⁸ of welding tortoise-shell is as follows:

When two pieces of shell are to be joined, the two edges are beveled so that one inclined edge may lie upon the other. The edges are scraped perfectly clean, contact with the fingers or any greasy substance being carefully guarded against. A piece of paper is then bound around the overlapping edges and fastened with a string. A pair of flat tongs or pincers, something like hair-dresser's tongs, are then heated and applied to the shell, one jaw of the pincers above and the other beneath, by means of which the shell is grasped throughout the length of the seam or overlap. By holding it a short time in this position, the heat of the iron penetrates through the paper, softens the shell, and causes the two pieces to unite firmly. Sometimes two pieces of shell are united by means of boiling water as follows: The two edges are overlapped, two pieces of metal are placed along the joining, the shell is placed in a press, and the whole is immersed in boiling water. As the shell softens, the press is screwed more tightly, by which the two pieces of shell become firmly united. Owing to the fact that the shell becomes mobile with heat, it is easily molded into almost any desired shape by means of boiling water and the screw press, and even small bits of shell are utilized by being thus welded together. If too much heat is used the shell becomes blackened, consequently in many places, especially in Japan, most of the work is accomplished by hand graving, following a pattern as in scroll work. The same method is followed in Manila, where the outfit of the workman consists simply of scraper, saws, files, and a bench. Manila has two small factories employing about six men (all Chinese), where crude combs (Plate VI, figs. 1 to 6) of tortoise-shell are made. There is also a small factory in Iloilo. All the work in this place is done by hand and is of the crudest sort.

The method used to weld tortoise-shell in Japan differs in slight detail. Dr. Shigeo Tawaka of the Zoological Institute, College of Science, Imperial University of Tokyo, kindly supplies the following information.

First of all, shells which are to be welded are just dipped in water and thus moistened, the shells are then put in between two thin pieces of magnolia wood (*Magnolia hypoleuca*) and then the whole thing is moderately pressed with a pair of heated pincers which have been dipped in water an instant before operating (a hissing sound is the usual sign of these being sufficiently heated). The welding of the shell is thus completed. The reason why they use the magnolia pieces is to avoid the direct contact between the heated pincers and the shell. The temperature of the pincers is not scientifically made known, being said to be the trade secret kept among the preparators.

The appearance of tortoise-shell frequently is given to horn by brushing it over with a paste made of two parts lime to one part litharge, and a little soda lye, which is allowed to dry on. Artificial tortoise-shell is manufactured by melting gelatine and various metallic salts.

VALUES AND GRADES OF PHILIPPINE TORTOISE-SHELL.

It is very difficult to arrive at a true valuation of tortoise-shell, owing to its variations and the reluctance of the Chinese merchants, who now control the trade, to give out any facts regarding the matter, but 4 different grades are

⁸ Simmonds, Commercial Products of the Sea. New York (1895), 355.

recognized. Two of the principal merchants of Zamboanga give the value of the first grade (which is not often found), as 50 pesos per kilogram while 2 principal dealers in Balabac quote the value of the first grade at 167 pesos per kilogram. These prices were quoted to customs officials. The value of the second grade is from 16 to 20 pesos per kilogram. A considerable portion of the Philippine shell falls in this grade (Plate V, figs. 1 and 2). The third grade is thinner and is valued at from 11 to 13 pesos per kilogram, while the fourth, consisting of small shell is valued at 4.16 to 8 pesos per kilogram. It usually is sold by the *catty*, which is equal to 1.39 pounds.

The value of tortoise-shell depends not only on the size and thickness of the plates, but also largely upon the coloring and marking, there being a great variation in the beautiful clouded and mottled patterns in the shell. The color most in demand at present seems to be the rather dark shell with but few light spots. Golden-colored combs, at one time greatly prized and to-day much used by ladies with blond hair, are made from the plates of the plastron or belly. The price of the shell also depends largely upon the prevailing style in ladies' hair dressing as well as upon the fashion in toilet articles. However, the demand for good tortoise-shell seems steadily to be increasing. Japan is the center of the work for oriental countries.

POSSIBILITIES OF TORTOISE-SHELL WORK IN THE PHILIPPINES.

Personally I have seen nothing in the Philippines which seems to offer so sure a return to a man with a small amount of capital, say 6,000 to 10,000 pesos, as the buying and working of tortoise-shell. The machinery required is but little. The manufactured articles would enter the United States duty free, thereby finding a ready market. The supply of shell is, on the average, about 2,000 kilograms per year, which would be sufficient to keep a small factory in operation and I have no doubt that the returns would be remunerative. The main difficulty would be to induce the Chinese middlemen to deal directly with the factory rather than with Shanghai or Singapore (the two places that take practically our total yield). A man who could buy directly from the fishermen would have a still larger profit.

CULTIVATION OF THE TORTOISE.

The cultivation of the hawksbill turtle has never been undertaken in the Philippines, but it is not improbable that it could be cultivated to advantage in much the same way as is the edible turtle (*Tryonix japonicus* Schlegel) in Japan. It is a subject worthy of consideration not only by private individuals but by the Government. A careful study of the habits, nesting places, rate of growth, and food of the hawksbill and green turtles should be undertaken with artificial cultivation in view, and if thought practical, steps should be taken to establish turtle farming, for practical and experimental purposes.

IV. THE PHILIPPINE WINDOW-SHELL.

DESCRIPTION.

In the majority of windows in the city of Manila, the pane is of shell instead of glass. The shell used for this purpose is called *kapas* or window-shell (*Placuma placenta* Linn.).

This shell (Plate VII, fig. 2) is thin and flat with a rounded outline, and somewhat resembles a very large wafer. The entire shell including the animal is about 1 centimeter in thickness (Plate VII, fig. 1) by 14 centimeters in diameter. The left side (valve) of the shell is slightly convex, the right side is flat. The right side is easily transformed into a windowpane simply by squaring off the edges with a big pair of scissors or a crude machine such as is used for cutting plug tobacco. The shells are then framed and are ready for use. The size of shell most in demand will square 7.5 centimeters, although those that square 6.5 centimeters are also much used. The opinion prevailing among the general public regarding window-shell is that it is a slab of shell split off from some larger shell. This, needless to say, is entirely erroneous, as the window-shell is used in its natural condition, the two halves being torn apart and the edges merely trimmed. The left side of the shell is convex and hence is in but small demand. Windows made of these shells are translucent, admitting a soft light, very grateful to the eyes in a tropical country.

The windows present a most attractive appearance (see Plate IX, fig. 1) and consequently are used in some of the handsomest structures in Manila, such as the American Cathedral, the new General Hospital, and the new Young Men's Christian Association building; and while they increase considerably the beauty of this type of architecture, they are also peculiarly adapted to, and make a most attractive appearance in, buildings of the bungalow style.

DURABILITY AND STRENGTH OF THE WINDOW-SHELL.

These windows of shell last for generations. Some of the old churches of Manila have shell windows which have been exposed to the weather for over a hundred years and which are still serviceable. Shell windows are easily repaired, as a new shell is readily sprung into place when one becomes broken or worn.

The strength of these thin, wafer-like shells is something astonishing. Below is given a table showing the relative strength of window-shell as compared with plate glass 2 to 3 millimeters in thickness by actual test in the Bureau of Science.⁹ It is shown by this table that window-shell is much stronger than plate glass 3 millimeters in thickness. The

⁹The tests were made by W. C. Reibling of the laboratory of inorganic and physical chemistry, Bureau of Science.

relatively poor showing of the Capiz shells probably is due to the fact that they were old and very dry; they also were somewhat smaller than those from Cavite.

Table showing the strength of window-shell compared with plate glass.

Material tested.	Average thickness.	Average weight per square cm.	Number of falls of a steel ball weighing 3.55 grams, necessary to produce failure on samples 2.54 cm. wide and supported at both ends 5 cm. apart.			Number of blows necessary to produce failure with 1 kg. weight with a rounded striking end falling 1 cm. high on specimen 7 by 7 cm. and supported at both ends 6 cm. apart.
			Height of fall.			
			50 cm.	100 cm.	150 cm.	
Capiz shells	0.8	0.162	50, not broken	6 to 61	Two	6 to 73.
Cavite shells	1.1	0.227	do.	50, not broken	50, not broken	390 to 1,500.
Glass	2		do.	One		1.
Glass	3		do.	do.		2.

GENERAL ANATOMY OF THE WINDOW-SHELL.²⁰ See Plate VIII (a-l).

These shells when alive are more or less transparent and in younger specimens the functions of the animal may readily be observed through them. Old specimens are thickened and opaque.

The largest and most striking object that attracts attention upon opening a window-shell is the mantle, or pallial lobe (Plate VIII, fig. a), which lines the interior of the shell, the margin of which has numerous, fine, finger-like projections forming the pallial fringe (fig. b); the mantle usually is much pigmented. When the left valve is removed and the left pallial lobe cut away, the 4 scimitar-shaped gills or branchiæ are exposed (fig. c). Near the center of the shell is the round, hard adductor muscle (fig. d) which has been cut in order to open the shell. Directly above the muscle, surrounding the stomach, is the large, yellowish-green liver (fig. e); directly to the right of this is the large, yellow, genital lobe (fig. f); originating just above the highest point of the gills is the foot (fig. g), a long tube-like organ extending to or beyond the edge of the mouth and ending in a disk which is usually full of mud. On the opposite side of the shell is seen a structure slightly similar but much smaller and ending in a disk; this is the anal funnel (fig. h). The intestine extends up to the stomach. Near the base of the foot, between two, thin, flap-like membranes, the labial palps (fig. i), is found the small, slit-like mouth. Between the lower genital lobe and the muscle will be seen a delicate, thin-walled organ, the heart (figs. j and k), consisting of 2 auricles and 1 ventricle. The aorta, with some of its large branches, is on the top of the liver. To the left and near the muscle are the kidneys, or nephridia (fig. l); dark colored, elongate organs. By dissecting between these and the muscle, a long, curved, cartilage-like rod is exposed. This is the crystalline style; it is inclosed in a sac, the pyloric cæcum.

²⁰ For a detailed and accurate account of the anatomy and histology of *Placuma placenta* L. we refer the reader to the excellent work of James Hornell, F. L. S., of the Madras Fishery Bureau, in a Report to the Government of Baroda on the Marine Zoölogy of Okhamandale in Kittrawar, Part I (1909), 43-90, 5 pl.

The nervous system is similar to that of other members of this order, being composed of the following three ganglia: (1) The cerebral ganglion may be seen by folding back the labial palps; it is a large, pale, orange-colored mass halfway between the base of the palps and base of the foot. (2) The pedal ganglion is on the base of the foot in the middle on the dorsal side. (3) The parieto-splanchnic ganglion will be found on the lower front curvature of the muscle close to the extremity of the kidneys. The byssus and byssus gland are absent.

DISTRIBUTION OF THE PHILIPPINE WINDOW-SHELL.

The window-shell is widely distributed throughout the Islands in certain definite areas. A large bed exists in Manila Bay, especially in the shallow arm of the bay east of Cavite known as Bacoor Bay. It is also found at Parañaque; in fact, the entire east end of the bay from Parañaque to Cavite is a potential bed for the window-shell. Kawit is the center of activity for window-shell fishing for the Manila Bay beds. Important beds also occur at Pangolao and Talibon in Bohol, at Valladolid in Oriental Negros; in Capiz, Masbate, and Iloilo; in the Province of Pangasinan, Luzon, and in numerous localities in Mindanao. Doubtless, there are a number of other places in the Islands where this shell is found which have not been reported. Iloilo supplies large quantities of shell for the Manila market. Shells from the Province of Pangasinan seem to be uniformly thicker and more opaque than Iloilo shells, but average slightly less in size, being 112 and 107 millimeters in diameter.

In no place in the Philippines are these shells fished for the pearls which they sometimes contain, but always for the shell alone.

HABITS, CULTIVATION, AND FOOD OF THE WINDOW-SHELL MOLLUSK.

The window-shell mollusk is usually found in shallow water, but has been known to exist in a depth up to 20 fathoms. It requires a bottom of grayish or bluish mud where more or less fresh water is carried in by streams.

There is a large variety of marine life found in the Manila beds, such as large quantities of clams and edible oysters; in fact, the cultivation of the oyster and the window-shell is carried on simultaneously by a number of fishermen. The oyster beds are staked off by their respective owners, and when fishing for window-shell or oysters outside of their claims, all the small and half-grown window-shell oysters are collected and planted on their oyster farms and kept there until they are mature. The young shells can not be sold as they are not large enough for windows. The adults keep the claim well supplied with spat.

The owners of these claims club together and hire a watchman, who is stationed in a house built over the water near the claims.

The yield of the Cavite beds is estimated at 14,000 adult shells for a good week's fishing. However, the fishing is intermittent, depending upon the demand and also upon the owner's need of ready cash. The shells are fished entirely at low tide in water of 1 meter or less in depth; the fishermen feel for them

either with their toes or their hands, just as the fancy strikes them. Adult shells are rather scarce on the public fishing grounds of these beds. I secured but 35 in one hour of fishing, but in ten minutes an owner of one of the planted beds secured 100 adult shells for me. These measured 118 to 135 millimeters in their greatest diameter.

The shell matures in three years. At the end of the first year it is 62 to 83 centimeters in its largest diameter. The sexes are separate, the eggs being fertilized in the water. The mature ova have a decided resemblance to the form (in outline) of the mature shell, while the spermatozoa have globular-shaped heads and extremely long tails, fully 10 to 15 times the length of the head. It is a comparatively easy matter to fertilize the ripe ova under artificial conditions by taking the ripe spermatozoa of the male in sea-water or normal salt solution.

The artificial fertilization and cultivation of this important commercial mollusk is well worth our careful consideration, and it is to be hoped that with the opening of the salt-water aquarium and fish hatcheries having running salt water, that the study of the life and cultivation of this shell will be made with great care and detail.

The food of the window-shell mollusk consists of small marine organisms, chiefly diatoms, which it collects from the water. The window-shell mollusk apparently does not move about, but lies flat on the mud on its convex, left side. The foot, instead of being a means of locomotion, is used to keep the mud from the gills and other organs.

QUANTITY OF SHELL AVAILABLE AND PRICES DEMANDED.

The supply of this shell in the Philippines is so large that at no place has it been found necessary to resort to diving for it, as is done in India, as plenty of shell is secured by wading in water less than 1 meter in depth and feeling about with the toes.

There are no laws regulating the gathering of window-shells, and so far as we have been able to ascertain there are no municipal ordinances relating to them.

It is estimated that there are 5,000,000 of these window-shells used each year in the City of Manila alone. A single lumber company of this city in 1910 used 1,500,000. The demand is increasing.

The price depends upon the size. Shells that will square 63 millimeters (2.5 inches) sell for 3 to 7 pesos (1.50 to 3.50 dollars) per thousand; while the large ones which square 7.5 centimeters (3 inches) sell for 8 to 10 pesos (4 to 5 dollars) per thousand. One window-shell fisherman explained to me that he had three prices for the first-grade shells. These were valued at 8 pesos per thousand to the Filipino, 10 pesos per thousand to the Spaniard, and 12 pesos per thousand to the American.

The Chinese traders do not hesitate to ask the amateur buyer 15 pesos per thousand. The shells usually are sold in large baskets, each holding 10,000 pieces.

The window-shell is not exported to any extent, the only shipment for last year being 1,458 kilograms sent from Iloilo to New York. However, it is expected that when the builders of bungalows in the United States, especially in California, recognize how much stronger, cheaper, and more attractive these shell windows are than the same thickness of glass, there will be a brisk demand for them in that country.¹¹

HOW WINDOW-SHELL IS USED.

Shell windows are made of narrow strips of wood usually 13 to 18 millimeters wide and 13 millimeters thick, or they may be any size desired. These strips are grooved on two sides and notched every 6.0 or 7.5 centimeters as the case may be, to receive the cross stick which also is notched; thus a solid square frame is formed for each shell. After these are put together the entire square is set in a solid frame to fit the window or door. (Plate IX.)

The following uses are also suggested for the shell:

Screens.—(Plate IX, fig. 2.) These shells make a most attractive and useful screen, made up either in three divisions in the usual form of the Japanese screen, or else in a single division like the Spanish screen.

Lights for verandas.—(Plate I, figs. 1, 2, and 3.) These shells make a most durable and desirable light for open verandas, as they lend themselves to a great diversity of forms, the shell being easily trimmed to fit into any form of opening. The old-fashioned lantern shape is a popular form for these lights.

Old mission shade lights (Plate X, fig. 3) are most attractive and serviceable; they are usually made up with hard-wood frames and large window-shells.

Conservatory windows.—These shells would be found most desirable by the owners of hot-houses or conservatories in countries where hail is prevalent or where the direct rays of the sun are too strong; they admit a soft light with a fair amount of heat, and the expense as compared to that resulting from breakage and painting or frosting of glass would be almost nothing.

Fronts to kitchen cabinets.—These window-shells would make up into most attractive fronts for kitchen cabinets, being easily kept clean and not liable to breakage.

A dozen other uses might be suggested for window-shells. We can most highly recommend them for almost any purpose to which opaque glass would ordinarily be applied, and I feel confident that, when their cheapness and utility are recognized in the United States, they will be exported in larger quantities.

V. PHILIPPINE SHELLS USED IN THE MANUFACTURE OF PEARL BUTTONS.

In addition to the pearl-oyster shells, which are exported from the Philippines in large quantities,¹² there are three varieties of shells found in these Islands and used in the manufacture of pearl buttons. These

¹¹ Names of Philippine dealers from whom window-shells may be obtained in quantity, can be obtained by applying to the Bureau of Science.

¹² See *This Journal*, Sec. D (1910), 5, 87 to 101 (with 6 plates).

are the great top shell (*Trochus niloticus* Linn.), the green snail (*Turbo marmoratus* Linn.), and the chambered nautilus (*Nautilus pompilius* Linn.).

THE GREAT TOP SHELL.

The great top shell (*Trochus niloticus* Linn.) (Plate XI, figs. 1 to 4) known locally as the lock, conic shell, trochus, *susong-dalaga*, or *samong*, is a large, conical, top-shaped shell, found in abundance in many islands of the Philippine Archipelago. Aside from the true pearl oyster, this shell is the one in greatest demand for manufacturing buttons. As a matter of fact, owing to its cheapness, it is frequently made into buttons in preference to employing the pearl oyster. The great top shell when mature is from 10 to 15 centimeters in diameter and a trifle less in height; it has many close whorls, the largest of which flares decidedly. The shell is marked with radiating or zigzag bands of red, violet, or brown; the aperture is oblique and has a spiral operculum. An adult shell 10 centimeters in diameter weights 330 grams.

The great top shell is usually found at low tide near the outer edge of coral reefs or under large rocks, and while small quantities may be encountered on almost any coral reef in the Archipelago, they are especially abundant in the vicinity of Sitanki, along the coast of Pangasinan, and Ambos Camarines, Luzon, and on the northern coast of Palawan, the eastern coast of Samar, and in the vicinity of Masbate. There are also numerous places on the coasts of Mindoro where they are abundant. I noticed a number of these shells washed up on the beach on the eastern side of the Gulf of Davao.

The soft portion of the great top shell is regarded by the Filipinos as a very fine article of food and, as a matter of fact, this species of mollusk is more sought after for its meat than for its shell. One proof of this is in the numerous piles of empty shells to be found on the beach in localities near the ocean. It is usually noticed that they have been placed on the fire, in order to cook the animal, after which it is easily removed from the shell. Of course, shells treated in this manner are spoiled so far as their commercial value is concerned. The proper way to remove the animal is to place the shell in hot water, as the shell is in no wise injured by this treatment.

So far as my experience shows, the great top shell is always more or less solitary and while five or six are frequently found under one large stone they never occur in beds or in great numbers over a given limited area.

The average annual export of this shell from the Philippines during the past four years has been about 350,000 kilograms valued at about 60,000 pesos. The price fluctuates greatly. For a considerable period the standard price was 7.50 pesos per picul for middle grade shells. The Manila

button factory, in 1910, was paying from 10 to 22 centavos per kilogram, depending on the grade. A small quantity of shell sent to the United States was sold for about 22 centavos per kilogram (5 cents gold per pound). Japanese button factories offered to buy, in large quantities, half-grown shells for 28 pesos per picul of 137.5 pounds. During May the price for great top shell in Zamboanga was 18 pesos per picul. During the past few weeks the price has fallen to 12 pesos.

The establishment of a second button factory in Manila, together with the evident desire on the part of American button factories to secure Manila shell, no doubt, are responsible for the increase in the price. The result will certainly be greatly beneficial to the trade as it will stimulate the gathering of these shells and the native fishermen will soon learn that it is more profitable to bring them to market than to destroy them by fire in order to extract the animal for food.

The one objectionable feature which must soon be taken into consideration is the desire of the Japanese buyers to secure the young, half-grown shells. It is very evident that if the young shells are taken it will not be long before there are none left to propagate. However, this is a condition that may easily be remedied by legislation. An adequate export duty on great top shells of less than 9 centimeters (3.5 inches) should be imposed at the earliest possible date.

No careful study has been made in the Philippines of the reproduction, habits, rate of growth, food, or the possibilities of artificial cultivation of this commercially important shell.

THE GREEN SNAIL SHELL.

The green snail shell (*Turbo marmoratus* Linn.) (Plate XII, figs. 1 to 4) known locally as turbo, sea snail, *lalong*, or *bulolo*, is a large, heavy, turban-shaped shell, found throughout the Philippine Archipelago, and largely used in the manufacture of buttons. It is not in as great demand as the great top shell, as it is considerably harder to work, and of less desirable color, having an opalescent instead of a pure white luster.

The green snail is the largest of the turbo family, sometimes reaching a diameter of 20 centimeters. The usual size is about 16 centimeters; the whorls are few, more or less knobbed; the body whorl is the largest; the aperture is nearly round.

The color of the shell is a rich green, mottled or spotted with brown and white. The very old shells lose much of the brown color, and show continuous bands of white following the whorls. When the rough outer layer is removed they are of a beautiful, opaline mother-of-pearl color inside and out.

In addition to being made into buttons they are also a favorite shell for cabinets, spoons, and drinking horns. The royal family of Scandinavia from time immemorial have had these shells studded with gems, mounted with silver, and formed into royal drinking cups.

The animal is highly esteemed as food by the Filipinos and is eaten in Japan also, where it is made into *chop suey*.

The green snail is found in the greatest abundance at the edges of coral reefs and in water several fathoms deep. It is also to be encountered along rocky shores under large boulders. The small islands in the vicinity of Cebu yield a considerable quantity. It is also fairly abundant along the coast of Negros and Masbate. The northern coast of Palawan also yields a large supply.

About 100,000 kilograms of the green snail shell are exported from the Philippines annually. The price paid to the fishermen ranges from 7.50 to 11 pesos per picul of 63.25 kilos.

As in the case of the great top shell, very little is known of the life history, habits, reproduction, or the possibilities of artificial cultivation of this shell in the Philippines.

THE CHAMBERED NAUTILUS.

The chambered nautilus (*Nautilus pompilius* Linn.) (Plate X, fig. 4) is so well known that a description is unnecessary. It is world-wide in distribution and is an inhabitant of water of from 300 to 350 fathoms in depth. China seems to be the only country that manufactures this shell into buttons, consequently its export from the Philippines is practically limited to that country.

The chambered nautilus is obtained in large numbers along the southern coast of the Island of Negros, sometimes as many as 3,000 nautilus shells being gathered in this region during one season. They are frequently caught in fish traps and are sold as a sort of "by-product" at 10 centavos each, although when brought into market the very fine, large specimens sell for much more. In many countries these shells are fashioned into spoons, vases, and pearl ornaments. A practical as well as an ornamental use has been made of these shells by the author, who has them mounted on red coralline, set in a solid base of red cement and with an electric globe fitted to the inside of the shell. This makes a most satisfactory reading lamp. (Plate X, fig. 4.) In Paris these shells are used for making the finest grades of cameos, and ornamental objects of pearl. They are among the most striking common shells in all museum cabinets. In New York City dealers charge from 2.50 to 5 dollars each for fine, large shells. Unfortunately the New York market is limited.

However, there is an increasing demand for these shells for the purpose of export, and some fishermen are found who give their entire time to catching nautilus. Ordinary bamboo fish-traps with funnel-shaped entrances are used. These are baited with crab and lowered into deep water, in a day or two they are drawn up and the nautilus removed. The Filipinos eat the flesh to a limited extent.

SUGGESTIONS FOR ESTABLISHING BUTTON FACTORIES IN THE PHILIPPINES.

Judging from the numerous letters of inquiry received by the ichthyological section of the Bureau of Science from various parts of the world regarding the establishment of button factories in the Philippines, this

is a subject of sufficient interest to warrant giving the following suggestions:

Location of factory.—Manila, Cebu, Iloilo, or Zamboanga would be a good place for the establishment of a button factory. The cost of renting a suitable building for a factory in either of these places would not exceed 50 dollars per month. A building would cost somewhat more than a similar structure in the country or coastwise districts in the eastern United States.

Labor.—The laborers would be Filipinos. They are found quite satisfactory by the Manila button factory, the pay in this factory being from 5 to 10 pesos per month, ten-hour days.

Power.—Steam or gasoline power would probably be found most satisfactory, although in all the places mentioned, except Zamboanga, electric power could be obtained. Wood as fuel is quite out of the question; coal costs from 10 to 14 pesos per ton in Manila. At Zamboanga water-power might be secured. Gasoline in Manila sells at from 4.50 to 5.00 pesos per 10 gallons; petroleum costs 1.40 pesos per tin of 5 gallons.

Taxation.—A manufacturer's license, costing 2.40 pesos, is required, and the internal revenue tax is one-third of 1 per cent of the gross receipts, payable quarterly.

Amount of shell available.—The amount of shell available for button making is about 450,000 kilograms of great top and green snail shell and 300,000 kilograms of pearl shell, making a total of about 750,000 kilograms (1,675,000 pounds) of shell per year.

Bleaching shell for button making.—A large portion of the button trade is with the Chinese and they require a very white button, consequently a bleach of some sort is necessary. The following method, given by Robert R. Williams of the laboratory of organic chemistry, Bureau of Science, is effective and cheap.

"Many processes are in existence for the bleaching of ivory, horn, and shell for ornamental or other purposes. When chemicals are used those having a solvent or oxidizing action on the organic matters in the horn or shell are chosen. Nowadays the most commonly used agent is hydrogen peroxide which may be had very reasonably in Europe and America. It is not feasible to use it at a distance from the factories making this chemical because of the deterioration in transit. Therefore it is more practicable to use a metallic peroxide and generate the hydrogen peroxide when needed. Barium or sodium peroxide may best be used, preferably the latter. The following process has been tested on shell buttons and found satisfactory. The buttons are first immersed in fuming sulphuric acid for ten to fifteen minutes. The acid is then drained off and may be used repeatedly if kept in well stoppered bottles. The buttons are then rinsed three times with water and covered with a 5 per cent solution of oxalic acid. Ordinarily 1 liter of buttons will require 1 liter of solution, though more is necessary for large or dark-colored buttons than for small or light ones. The oxalic acid solution should be kept ice cold if possible or at least below 20° C. Commercial sodium peroxide is now added in small quantities with constant stirring till the solution is alkaline to litmus paper. About 40 to 45 grams will be required per liter according to the purity of the chemicals. A very little of the 5 per cent oxalic acid solution is now added till, after stirring, the solution reacts acid to litmus. It is important that the solution be acid, but a large excess of acid is to be avoided.

"The buttons are allowed to lie in this solution for 24 to 72 hours according to their size and color. Bleaching proceeds better and more rapidly if the buttons are exposed to direct sunlight while lying in the liquor. This can be done in colorless glass jars which, if possible, should be tightly stoppered.

"The buttons after removal from the bleach liquor may be washed with water containing a little hydrochloric acid. This removes the encrustation from the outside and brings out the luster. After washing again with water they are ready for the further processes of manufacture.

"It will be found that buttons can be bleached effectively by this means and that the strength of the shell is increased by the deposition of calcium oxalate in the interior."

VI. PRECIOUS CORAL.

A small spray of true precious coral (*Corallium* sp.) was found on the beach of the Gulf of Davao, Mindanao, directly in front of the small station called Vigas. This specimen resembled very closely a species of Japanese precious coral (*C. japonicum* Kishinouye).

As it is not improbable that considerable quantities of precious coral eventually may be discovered in the Islands, it seems worth while to give a short description of this article of commerce, and to describe the methods employed in coral fisheries.

DESCRIPTION OF PRECIOUS CORAL.

The precious coral of commerce in its natural state closely resembles a small shrub, or the branch of a tree from which the leaves have been removed. Each stem and twig of this coral shrub has a hard central axis, or skeleton. Outside of this and similar to the bark on a plant is the thin soft covering or skin, which is easily rubbed off when fresh and is friable when dry. There are numerous small holes in the "skin" through which minute, flower-like animals project when the coral is alive; these are the coral animals (zooids); each of them has 8 small arms or tentacles around its mouth, with which it gathers food. All of these zooids are connected by a vascular system inside of the skin.

The hard part or skeleton is the valuable portion of the coral. It is made up of fused spicules consisting of carbonate of calcium with a small amount of silica and magnesia. The structure is concentric with radiating lines. The entire skeleton is very hard and so compact that no pores can be seen in a cross-section without the aid of a lens. This furnishes an easy test for distinguishing the precious coral from the numerous varieties of no value.

In color these corals range from white or delicate pink to dark red. Precious corals reproduce sexually, and by budding. The reproductive organs are internal and attached to the faces of the mesenteries; they shed their contents within the body where fertilization takes place. The precious corals are believed to be viviparous. Colonies are sometimes composed entirely of males, sometimes entirely of females, frequently all on one branch are males, while all on another branch of the same colony are females. Occasionally both sexes are combined in one animal, forming a hermaphrodite. The eggs contain a considerable amount of yolk and when hatched the larval forms are free swimming and may move a fair distance before they settle and become fixed.

The food of the precious corals consists of living organisms; they have been known to eat the powdered flesh of fishes.

VARIETIES AND DISTRIBUTION OF PRECIOUS CORALS.

The best known species of precious coral is *Corallium nobilis* Pallas, more generally known under its synonym of *C. rubrum* Linn. This species is found in the Mediterranean Sea off the northern coast of Africa, also off the coast of

Tunis, Sardinia, Italy, Corsica, and at the Cape Verde Islands. Eight species of precious coral have been described from Japan. These are *Corallium japonicum* Kishinouye, *C. elatius* Ridley, *C. boshuensis* Kishinouye, *C. sulcatum* Kishinouye, *C. pusillum* Kishinouye, *C. inutile* Kishinouye, *C. confusum* Moroff, and *C. konojoi* Kishinouye. Two species, *C. johusoni* (Gray) and *C. maderense* (Johnson), are found in Madeira. *C. stylasteroides* (Ridley) occurs in Mauritius, *C. regina* (Hickson) is found in Timor, and *C. secundum* (Dana) has been found at Banda, Ki Islands and in the Hawaiian Islands. This constitutes the entire list of established species of precious corals known to the present time.

The vertical distribution of these corals in the sea varies from 5 to 500 or more fathoms. They are found attached to rocks, dead shells, or dead coral; some species seem to prefer overhanging, submarine cliffs.

In general the vertical distribution of the Japanese species ranges from 50 to 180 meters, while in the Mediterranean fisheries the work of obtaining the coral is usually carried on in waters of much greater depth.

FISHING FOR PRECIOUS CORAL.

Fishing for precious coral is almost always carried on by means of various sorts of dredges. In Japan the dredge consists of a rectangular bag net about 1.5 meters wide and 1 meter high, with a 13 centimeters mesh, this is fastened to a frame of bamboo, tufts of old netting are fastened to the lower edge of the net and at the sides. These collect many broken coral branches. The coral fishing boats are allowed to drift over the banks with the sails at half mast. The net is allowed to touch the bottom and proceeds with a jerking motion. When the fishermen think they have secured or fastened to coral they pull up the net.

The dredge used in the Mediterranean coral fisheries is of wood in the shape of a large cross with a heavy stone attached to the extremity of the lower arm and with coarse, twine bags of large mesh and with numerous tangles of frayed ropes attached to the anterior arms. Numerous variations of this, as well as ordinary tangles, are also used.

USES AND VALUE OF PRECIOUS CORAL.

The chief use of precious coral is in the manufacture of coral beads and ornaments. It is first sorted into different grades, of which there are several recognized in commerce; it is then cut into suitable pieces and all necessary holes are drilled in it. It is then filed into any shape desired, and engraved. Next it is polished with pumice stone and water, followed by a polish of very fine chalk and water. Oil is never used on coral.

The value of precious coral depends upon its color, form, and quantity. A string of large uniform beads may be bought in Italy for 20 pesos, while a string of beads of similar size but of the best quality will cost 400 pesos. Japanese precious coral in its native state sells for from 100 to 500 pesos per kilogram, and the best Mediterranean sells for twice these amounts.

The export value of coral from Japan is about 500,000 pesos per year.

THE CULTURE OF CORAL.

The culture of precious corals has not received the careful scientific attention that it should.

C. nobilis has been kept alive for some time in aquaria, and if it were planted under natural conditions possibly it could be grown with profit. Careful experimenting along this line might lead to useful and valuable information.

LITERATURE ON PRECIOUS CORAL.

- KISHINOUE, K. Notes on the Natural History of Corals. *Journ. Imp. Fisheries Bur.* (1904), 14, 1-32, (13 plates).
- KITAHARA, T. On the Coral Fisheries of Japan. *Journ. Imp. Fisheries Bur.* (1904), 13, 1-14 (5 plates).
- THOMPSON and HENDERSON. Report on the Alcyonarian Corals Collected by the Investigator. *Pub. Indian Mus.* (906), pt. I, 120.¹³
- WRIGHT and STUDER. Challenger Report (1889), 31, 185.
- JOHNSON, J. Y. Notes on the Corallidae of Madeira with Descriptions of two New Species. *Proc. Zool. Soc.* (1899), 57.
- RIDLEY, S. O. On the Arrangement of the *Corallida*, with Descriptions of new or rare Species. *Proc. Zool. Soc.* (1882), 221.
- DANA, J. D. United States Exploring Expedition. *Zoöphytes*. Phil., (1846), 8, 641.
- LACAZE-DUTHIERS. *Histoire Naturelle du corail*. Paris (1864).
- MOROFF. On a New Species of coral from Sagami Bay, Japan. *Zool. Jahrb. Syst.*, (1902), 17, 404.

BLUE CORAL.

In numerous localities throughout the Philippine Archipelago a fine quantity of blue coral, *Heliopora cœrulea* Linn., is found in considerable quantities, usually in water of from 2 to 10 fathoms depth.

This coral is a beautiful, permanent, cerulean blue in color. It takes a fine polish and is found in large heavy masses. No doubt it could be used in jewelry and ornamental work. No amount of polishing, however, will entirely obliterate the pores. I have collected this coral at Jolo, and at Butuan, Mindanao, on the eastern coast of Samar, and on the northern coast of Palawan. No use is made of it at the present time, but as a body for broaches, bracelets, etc., it would be very beautiful or as a background for pearls it would, in my judgment, be unsurpassed.

RED ORGAN-PIPE CORAL.

The red organ-pipe coral (*Tubipora* spp.) is very common throughout the Philippines. It has no especial value, its only use apparently being for cabinet specimens. It is a shallow-water form. I have seen large blocks of it used with other corals in the construction of a wharf.

REEF CORALS.

The common reef corals comprising a great variety of genera and species, which have as yet never been identified, are used largely in the building of roads throughout the Islands. They are employed to a limited extent in the manufacture of lime.

BLACK CORAL.

The so-called black coral (*Antipatharia* sp.) is very common in the Philippines. Fine specimens several meters in length and from 5 to 15 millimeters in diameter are common throughout the Jolo Archipelago. It is also found in larger quantities in the Gulf of Davao, Mindanao and near Cebu. It is usually secured in water of from 10 to 20 fathoms.

The U. S. S. *Albatross* dredged large quantities of this "insulated cable wire" as it was called by the sailors and this term, indeed, is fairly descriptive of the body of this coral; however, the branches are very numerous and give the small corals a decidedly shrub-like appearance.

¹³ This report includes a complete bibliography relating to corals.

This coral is used chiefly for making canes, as it is easily straightened or bent into any desired shape by immersion in hot water for a short time. It takes a most beautiful jet-black polish and could doubtless be used in the manufacture of coral beads and rosaries. A cane of this coral nicely prepared and polished can be bought for from 5 to 10 pesos. The raw material has very little value at present.

VII. EDIBLE SEAWEEDS OF THE PHILIPPINES.¹⁴

In connection with the series of articles on minor marine products, it has been thought advisable to include what is known regarding the edible seaweeds, with the hope that the publication of the meager data available may stimulate interest in the subject. Below is given a list of the species known to be used for food, and it is confidently expected that eventually it will be greatly extended as data on the subject become available. Very little seems to have been published on the subject. The determinations have kindly been made by Dr. M. A. Howe, of the New York Botanical Garden. The list is for the most part based on a collection made by Eugenio Fénix of the Bureau of Science, in Union Province, Luzon, supplemented by some local observations in and about Manila.

In most parts of the Philippines, along the seashore, various species of marine algæ or seaweeds are found, although in this Archipelago as in most tropical countries, these are not found in masses, or in such great quantities as is the case with many forms in temperate regions, at least in shallow waters.

The first impression on studying Philippine algæ is that the number of species is very limited, but intensive collecting has brought to light a considerable number and, doubtless, as botanical exploration progresses, the list of Philippine algæ will be greatly increased. In some regions the marine algæ play no small part in the economy of the natives, a considerable number being used for food, thus entering into the local commerce.

At the present time a large percentage of our material is unclassified. Doubtless very many of our species are used for food, but collectors have given this phase of the subject comparatively little attention, so that the data on the utilization of local marine algæ are very fragmentary.

Seaweeds are used for food both raw, in the form of salads, and cooked sometimes with vegetables, such as tomatoes, and sometimes with the addition of sugar, forming the dish, popular among the natives, known to the Tagalogs as *gulaman*. It is probable that in Manila, at least, a large part of the *gulaman* is made from prepared seaweeds imported by the Chinese, although the local product is almost always to be found in the markets. In Manila various species of algæ are known as *gulaman*, but the most important appear to be *Aghardella* sp. (*Fucus gulaman* Blanco), and *Gracillaria confervoides* (L.) Grev.

¹⁴ Data supplied by E. D. Merrill, botanist, Bureau of Science.

Aghardhiella sp. (*Fucus gulaman* Blanco). This species is common in Manila Bay and is universally known to the Tagalogs as *gulaman*. It is probably the most generally used species in Manila, and during certain seasons is almost always to be found in the native markets.

Chaetomorpha crassa (Ag.) Kütz. Known in Union Province as *cauat-cauat*, and locally used for food.

Codium tenue Kütz. Known in Union Province as *pupu-lo*; edible.

Enteromorpha intestinalis L. This green alga is abundant in brackish water about the mouths of streams, and is eaten by the natives to some extent.

Euचेuma spinosum (L.) J. Ag. Known in Union Province as *rupruppuuc*; edible.

Gracillaria confervoides (L.) Grev. Abundant in Manila Bay at certain seasons, locally known as *gulaman*, and sold in the native markets of Manila.

Gracillaria crassa Harv. Used for food in Union Province; known to the Ilocanos as *susuedot-baybay*.

Gracillaria euचेumoides Harv. Known in Union Province as *canot-canot*; edible.

Gracillaria lichenoides (L.) Grev. Known in Union Province as *guraman*; edible. The above four species are allied to a Japanese species largely used in the manufacture of agar-agar.¹⁵

Halymenia formosa Harv. Known in Union Province as *gamet*; there used for food. An allied species found in Manila Bay, native name unknown, is doubtless also edible.

Liagora cheyneana Harv. Known in Union Province as *baris-baris*; edible.

Sargassum siliquosum J. Ag. Known in Union Province as *aragan*, there used for food. Widely distributed in the Philippines, as are several other species of the genus, all of which are doubtless utilized to a greater or less extent as food.

VIII. THE PREPARATION OF ISINGLASS IN THE PHILIPPINES.

The preparation of isinglass is an industry that could be carried on easily in the Philippines, but so far as I have been able to ascertain, it has never been inaugurated.

Isinglass is the purest form of commercial gelatin known: it is prepared from the "sounds" or air-bladders of certain fishes.

The preparation is very simple and requires no outlay of capital. The exact method of procedure is as follows:

Remove the air bladders (also called "maw", "swim bladder") from the fishes soon after they are caught, slit them open and wash thoroughly, take off any thin membranes which envelop them. Then expose to the air to stiffen. If oily, wash in lime water, then in fresh water and dry. They should be put to dry on "flakes" or nets so the air will have free access to all parts. It is sometimes desirable to give slight pressure in which case they may be dried between sheets of paper, or flat driers, like botanical specimens. When thoroughly dry they are put up in convenient packages and are ready for market.

¹⁵ The well known seaweed-isinglass, or *agar-agar* of Japan, is made from an alga of the genus *Gelidium*. This genus has not yet been reported from the Philippines.

USES OF ISINGLASS.

Probably the chief use of isinglass is in fining liquors of various sorts, especially the best grades of wine. It is also used in the preparation of creams and jellies, in stiffening fabrics, and in lustering ribbons. Isinglass is also used in the manufacture of court plaster, artificial pearls, diamond cement, and imitation glass.

It is true that owing to the expense of securing pure fish isinglass, agar-agar prepared from seaweed, is used largely as a substitute. However, there is no question that pure, fish isinglass is more desirable and gives better results in almost all cases than the vegetable product.

FISHES FROM WHICH ISINGLASS IS SECURED.

The best grade of isinglass is secured from the sturgeon and is put up in Russia. In the Malay Archipelago a very fair grade of isinglass is secured from the fishes called thread-fin and from certain species of catfish and croakers. In the Philippines, a profitable source of isinglass could be found in the thread-fin, *Polydactylus plebeius* (Brouss.), called *mamali* in Tagalog, and *tatik* in Moro. It is a very common fish in the Manila markets, and ranges in length from 35 to 50 centimeters. The common catfish (*Netuma nasuta* Bl.), called *kanduli* in Tagalog, which is very abundant, especially in Laguna de Bay, also supplies a good grade of isinglass. In addition, there are several species of croakers, (*Otolithes argenteus* Kuhl & Van Hasselt), (*Otolithes leuciscus* Gunth.), and *Johnius belengeri* C. & V.), and at least two species of *Umbrina*, from all of which isinglass can be secured. The above are all common market-fish and *it has been estimated that the isinglass thrown away from them is greater in value than the price secured by the fisherman for the entire fish.*

VALUE OF ISINGLASS.

The current value of isinglass quoted from a late trade journal is as follows:

Russian isinglass, 2.75 to 3 dollars per pound; American isinglass, 0.73 to 0.75 dollar per pound; 14,000 pounds were imported into New York during the month of April, 1911.

There seems to be no local demand for this product, but, owing to the recent tariff regulation, it would enter the United States duty free; consequently, it could be exported from the Philippines with profit.

IX. PREPARING SKINS OF AQUATIC ANIMALS FOR LEATHER.

CAYMAN OR CROCODILE SKIN.

(*Crocodilus porosus* Schneider and *C. palustris* Lesson.)

For commercial purposes, skins of the medium-sized cayman, of about 3 meters (9 feet) length, are the most desirable as they are easier to tan, and make the best leather. The skin should be cut along the middle line of the belly from the chin to the tip of the tail and carefully removed

from the animal soon after its death. Fine salt in sufficient quantity should then be rubbed thoroughly into the raw side of the skin. It is then rolled compactly and placed in a dry place to cure; occasional examination should be made to see if it is curing properly. When thoroughly cured the skin is ready for tanning.

To tan, it is first soaked in a tub of clear fresh water from two to six days—depending on the size of the skin,—a 3-meter skin requires about five days. It is then placed in a rather weak solution of lime and water which should be increased in strength daily for about ten days. The wet skin is now placed on a smooth beam, raw side out, and all the fat or flesh rubbed or shaved off. It is then placed in a thick mixture of bran and water and allowed to soak for one day—this is to neutralize the alkali of the lime. During all of the above processes through the solutions it is better if the skin be agitated occasionally so that all parts receive sufficient treatment. The hide is then washed and immersed in a tank of tanning extract. Any of the native tans may be used, or oak bark, gambia, or sumac liquid of 4 per cent strength, and stronger liquid is added each day until the strength has reached 20 per cent at the end of eighteen days. The length of time will vary according to the size of the skin, strength of the solution, or the color desired. The hide is then hung up to dry and harden. It is then shaved and cleaned again so as to leave it of the desired thickness. If black, red, brown, or green shades of color are desired the skin is put into a bath of wood and aniline dyes, for about three-quarters of an hour. It is then stretched out and nailed to a board or wide frame for drying. When dry it is rubbed briskly over an iron or wooden beam to make it flexible.¹⁵ The skin is then ready for use. The price paid for prepared skins is from 2 to 4 pesos per 20 lineal centimeters.

So far as I have been able to learn no serious attempt has been made to prepare the Philippine crocodile skin for leather. It is an experiment well worth trying, as the cayman is notoriously abundant in many streams of the Philippines.

WATER-SNAKE SKINS.

(*Lapemis hardwickii* Gray, *Chersydrus granulatus* Schneider, and other species.)

There are great numbers of water snakes in the Philippines. I have seen more than one hundred brought in with one haul of an ordinary fish sein on the Malate beach. It is quite probable that a good industry could be built up in tanning the skins of these snakes for leather. Many of them are finely marked and would make attractive belts, card cases, and ornamental objects. Considerable quantities of snake-skin leather are used in France. The following is the method of preparation:

The skins are removed from the animals and soaked for ten days in a strong solution of sulphate of zinc. They are then fleshed, scraped, washed by hand, and placed in a bath containing 100 parts water, 10 parts borax, 100 parts boracic acid, 25 parts tartaric acid, and 25 parts saturated solution of precipitated alumina. They remain in this bath one day and are then transferred to bath No. 2 containing 1000 parts water, 25 parts phosphate of zinc, 25 parts benzoate of aluminium, 50 parts glycerine, 20 parts alcohol. The skins are

¹⁵ Report U. S. Fish Comm. (1902), 350.

left one day in this solution, then they are placed in the first bath again for one day, then back into the second for another day, this alternating of baths being continued for five or six days, by which time the tanning is complete. The skins are then dried, lightly staked, and finished off.

PREPARING SHARK SKIN.

Shark skin is used for a great many purposes, especially for sword grips, knife and sword sheaths, for polishing wood and ivory, and for covering small ornamental objects, such as jewel boxes or card cases. A manufacturer in Paris has made a big reputation by tanning the skin of the Malabar shark into morocco leather.

Some very beautifully marked sharks are found in the Philippines such as *Chiloscyllium indicum* (Gm.), *Stegostoma tigrinum* Linn., *Seyllium capense* Mull. & Hen., and *S. marmoratum* Gray & Hard. Their skins could be made into excellent leather.

To tan shark skins, the skins are (if hard) first soaked in water for four or five days; they then are placed in a solution of lime and water, as in the case of the crocodile skins; they remain in this solution from two to six days, and are then washed free of lime, and soaked in bran water for a day or so; they are then fleshed, or shaved, and immersed in an alum solution composed of 0.5 kilogram of alum and 0.1 kilogram of salt to 4 liters of water; they remain in this solution two or three days, with occasional stirrings. On removal they are dried and are ready for manufacturing.

To prepare shark's skin for the use of cabinet-makers it is merely cleaned and not tanned, the hard dry skin is soaked in lukewarm water for three or four days, shaved on the flesh side, and then dried. This skin will outwear many sheets of sand-paper of equal size.

We are indebted to Chas. H. Stevenson's valuable paper regarding methods of tanning, for much of the above information.¹⁷

X. A CHECK LIST OF PHILIPPINE HOLOTHURIANS.

1. *Cucumaria conjungens* Semper.

General color brownish. Habitat: Mariveles, Luzon. In shallow water. Length 20-25 millimeters.

2. *Cucumaria longipeda* Semper.

Color dull gray. Habitat: Bohol, Pandanon. In water of 30 fathoms. Length 20 millimeters.

3. *Cucumaria citrea* Semper.

Color orange-yellow. Habitat: Bohol. In 8 fathoms. Length 15-20 millimeters.

4. *Cucumaria versicolor* Semper.

General color olive-green. Habitat: Bohol. In water of 6 to 10 fathoms. Length 6-7 centimeters.

5. *Cucumaria maculata* Semper.

Habitat: Bohol. In water of 10 fathoms. Length 4.5 centimeters.

¹⁷ Report U. S. Fish Comm. (1902), 283.

6. *Cucumaria mirabilis* Théel.
Habitat: Cebu, at the depth of 100 fathoms.
7. *Cucumaria canescens* Semper.
Habitat: Bohol. In water from 6 to 30 fathoms. Length 1.5–3 centimeters.
8. *Mülleria nobilis* Sel.
General color dusky. Habitat: Bohol. In shallow water.
9. *Mülleria mauritiana* Quoy & Gaim.
Habitat: Philippines. In shallow water.
10. *Mülleria lecanora* Jæger.
General color dirty yellowish. Habitat: Philippines. In shallow water up to 6 fathoms.
11. *Psolus complanatus* Semper.
General color grayish. Habitat: Zamboanga. In shallow water. Length 22 millimeters.
12. *Psolus boholensis* Semper.
Upper portion gray, lighter below. Habitat: Bohol. In water from 6 to 17 fathoms. Length 15 millimeters.
13. *Psolus boholensis pandanensis* Semper.
Habitat: Bohol at Pandanon. In water of 30 fathoms.
14. *Thyone villosa* Semper.
General color yellowish-brown. Habitat: Philippines. In water of 10 fathoms. Length 20–30 millimeters
15. *Thyone rigida* Semper.
General color grayish brown. Habitat: Bohol. In 10 fathoms.
16. *Thyonidium cebuense* Semper.
General color brownish gray. Habitat: Cebú. In 10 fathoms. Length 30–35 millimeters.
17. *Echinocucumis adversaria* Semper.
General color grayish. Habitat: Bohol. In 30 fathoms. Length 8–10 millimeters.
18. *Haplodactyla molpadioides* Semper.
General color pale-violet or lavender. Five branching papillae around the anal pore. Habitat: Bohol, Cebú. In 13 to 20 fathoms.
19. *Haplodactyla molpadioides pellucida* Selenka.
Habitat: Cebú. Shallow water.
20. *Chirodota rigida* Semper.
Color light brown with whitish dots. Habitat: Bohol.
21. *Chirodota incongrua* Semper.
Sixteen tentacles, each with 18 to 20 digits. Habitat: Camiguin Island. Shallow water.
22. *Chirodota dubia* Semper.
Tentacles 18, each with 18 to 20 digits. Habitat: Camiguin Island. Shallow water.
23. *Chirodota variabilis* Semper.
Tentacles 17 or 18, each with 20 to 24 digits. Habitat: Mariveles, Luzon.

24. *Chirodota panaensis* Semper.
Habitat: Panay. Shallow water.
25. *Synapta dubia* Semper.
Habitat: Bohol. In water from 6 to 10 fathoms.
26. *Synapta pseudo-digitata* Semper.
Habitat: Bohol. In water of 15 fathoms.
27. *Synapta molesta* Semper.
Habitat: Philippines. In shallow water.
28. *Synapta reticulata* Semper.
Habitat: Philippines. In water of 8 fathoms.
29. *Synapta indivisa* Semper.
Tentacles 13, each with about 20 very long slender digits. Habitat: Zamboanga.
30. *Synapta nigra* Semper.
Digits of tentacles united by web at base. Habitat: Bohol. In shallow water.
31. *Synapta grisea* Semper.
Color in life greenish-gray, arranged in spots and bands, the ground color being a dirty light-green. Habitat: Bohol. In water from 4 to 6 fathoms.
32. *Synapta glabra* Semper.
Color dark yellowish-brown above, yellowish below. Habitat: Cebú, Bohol. Length 500 millimeters. Found in water from 4 to 6 fathoms.
33. *Synapta innominata* Ludwig.
Habitat: Manila Bay.
34. *Synapta recta* Semper.
Thirteen tentacles, with very short digits. Habitat: Bohol. In water of 6 to 8 fathoms.
35. *Synapta gracilis* Semper.
General color whitish with slight wash of yellowish-brown. Habitat: Manila Bay.
36. *Synapta beselii* Jæger.
Color in life greenish. Habitat: Cebú reefs.
37. *Synapta similis* Semper.
Pinkish-white, with some brown anteriorly. Habitat: Bohol. In shallow water.
38. *Ocnus pygmæus* Semper.
Upper color greenish, the underparts yellowish-brown. Habitat: Bohol. In water of 9 fathoms. Length 10 millimeters.
39. *Ocnus imbricatus* Semper.
General color yellowish-brown, lighter below. Habitat: Bohol. In water of 8 to 15 fathoms. Length 35-40 millimeters.
40. *Colochirus cœruleus* Semper.
General color pinkish and green with markings of yellowish. Habitat: Bohol. In water of 10 fathoms. Length 18-20 centimeters.
41. *Colochirus viridis* Semper.
General color sea-green. Habitat: Zamboanga, Mindanao. In shallow water.
42. *Colochirus cucumis* Semper.
Habitat: Bohol. In 6 fathoms. Length 3 centimeters.

43. *Colochirus anceps* Selenka.
General color orange, the feet red. Habitat: Bohol. Shallow water up to 10 fathoms. Length 8-10 centimeters.
44. *Colochirus cylindricus* Semper.
Habitat: Bohol. In water of 10 fathoms. Length 5 centimeters.
45. *Colochirus tuberculosus* Quoy & Gaim.
Habitat: Bohol. In shallow water and up to 10 fathoms.
46. *Colochirus quadrangularis* Less.
Habitat: Bohol. In shallow water and up to 10 fathoms.
47. *Stichopus variegatus* Semper.
Yellowish-gray with markings of gray and brown. Habitat: Philippines. In shallow water up to 10 fathoms.
48. *Stichopus naso* Semper.
General color yellowish-gray. Habitat: Bohol. In 10 to 15 fathoms.
49. *Holothuria marmorata* Jæger.
Auburn above, with some large spots or bands of yellowish-white; yellowish below. Scattered over the sides of the body are violet spots on a yellowish-white area. The deposits in the body wall are X-shaped, or oval with central incisions on each side. Habitat: Bohol. In shallow water.
50. *Holothuria tenuissima* Semper.
Pedicels all over the body. The deposits consist of incomplete rosettes, or slightly branched rods. Habitat: Bohol, in 15 fathoms of water.
51. *Holothuria similis* Semper.
Fine papillæ all over the body. Habitat: Bohol, in 10 to 15 fathoms of water.
52. *Holothuria erinæus* Semper.
Color dark-brown or blackish, lighter below; pedicels a light yellowish-brown. The rods bear a few spines on their sides, their ends are slightly branched or perforated. Habitat: Bohol and Luzon, in shallow water.
53. *Holothuria græffeii* Semper.
Ventral pedicels in three distinct longitudinal series. The dorsal papillæ large. The deposits consist of tables, rosettes, and irregular branched plates. Habitat: Luzon.
54. *Holothuria pulchella* Selenka.
The ventral pedicels are more crowded than the dorsal papillæ. The spire of the table consisting of a reduced almost annular disk, with 12 teeth on the top. Habitat: Philippine Islands, in shallow water.
55. *Holothuria pervicax* Selenka.
Color in alcohol grayish-brown, with some darker cross bands on the back. The pedicels and papillæ are about the same size. The ventral surface is more crowded. The tables are not well developed, the spire being short and terminating in but 4 teeth; disks small, rounded, smooth or slightly uneven on the margins. Rods small, elongate, and uneven on the margins, or with holes on the sides. Habitat: Philippine Islands.
56. *Holothuria atra* Jæger.
Dorsal papillæ and ventral pedicels of nearly equal size. Disks forming simple rings; often with small hole at the base of each vertical rod. The spire terminating in 8 horizontal and 4 vertical teeth. The plates are evenly rounded, or

undulated on margins, often with X-shaped branches. Habitat: Philippine Islands, in shallow water.

57. *Holothuria edulis* Lesson.

Color a dark reddish-brown, light gray on sides and belly, a minute, dark ring around the base of the pedicels. The dorsal papillæ are very minute and more scattered than the ventral pedicels. Disk of the tables reduced to a small ring more narrow than the top of the spire, which, when seen from above, presents a small circular hole surrounded by 4 prominences, each with 4 or 5 teeth. Habitat: Bohol, in 10 to 20 fathoms of water.

58. *Holothuria monacaria* Lesson.

Color yellowish white, speckled with brown or greenish-brown on the back. The young specimens are auburn, with the ventral surface white. The papillæ paler. The dorsal papillæ are arranged in 4 indistinct longitudinal rows. The rounded disks of the tables have a central hole surrounded by 4 to 12 holes. The spire terminates in 12 teeth. Habitat: Zamboanga, in shallow water. Length 110 millimeters.

59. *Holothuria vagabunda* Selenka.

The color varies from a dark brown to a reddish-brown. The tables have small disks; the spires terminate in 8 to 10 teeth placed around a nearly circular aperture at their top; buttons with 6 holes; the dorsal pedicels alone have supporting rods, these are spinous and taper towards the ends. Habitat: Philippines, in shallow water.

60. *Holothuria fusco-cinerea* Jäger.

Color dusky-red, with some darker transverse bands on the back. The tables never seem to attain the usual length of the spire, nor to have the usual number of transverse beams. Habitat: Bohol, in 6 to 10 fathoms of water. Length 222 millimeters.

61. *Holothuria immobilis* Semper.

Color on dorsal surface brown, with some darker spots or bands, belly dirty yellowish-white inclined to brown anteriorly. Tentacles 26; ventral surface with pedicels, the dorsal surface with papillæ. The disks of the tables spinous; the buttons irregularly formed, with about six holes. Habitat: Bohol, in from 6 to 8 fathoms of water.

62. *Holothuria coluber* Semper.

The dorsal surface with papillæ; ventral surface with pedicels. The tables have long spire of 4 rods, and 3 to 5 transverse beams. Habitat: Bohol, in 6 to 8 fathoms.

63. *Holothuria impatiens* Forskål.

Color in alcohol, light brown, inclined to violet. Integuments rough, the smooth disks of the tables are pierced with 9 holes of equal size; buttons symmetrical with 6 holes. Habitat: Philippines, in 6 fathoms.

64. *Holothuria scabra* Jäger.

The color varies with different localities. Some are cinereous with almost black transverse bands, with a few small whitish bands or spots on the back, the belly being yellowish-white, and each papilla being surrounded with a small dark circle. In other localities they are paler and punctated with a few large dark spots, but are without the dark bands. The tables are solid, with smooth, well developed disks, spires of usual shape with 12 to 16 teeth. The buttons have 6 holes, are symmetrical, and for the most part knotted. Habitat: Bohol, in shallow water. Length 170 millimeters.

65. *Holothuria albiventer* Semper.

Belly dirty gray, finely punctated; papillae whitish; back dusky; tentacles yellowish-white. The tables have large rounded disk with numerous small holes. The spire is formed by 6 or 10 rods, its large rounded top is covered with small teeth; buttons oval. Habitat: Bohol, in shallow water.

66. *Holothuria squamifera* Semper.

Papillae scale-like. Tables small, numerous; spire long narrow, with 5 transverse beams; buttons with from 6 to 12 holes. Habitat: Philippines.

THE MOST IMPORTANT WORKS RELATING TO TREPANG.

- SEMPER, C. *Reisen im Archipel der Philippinen* (1868), 1, pt. 2.
 THÉEL, H. Report of the Scientific Results of the Exploring Voyage of H. M. S. Challenger, 1873-76. *Zoology* (1882), 4, pt. 3: (1886), 14, pt. 2.
 PEARSONS, J. Report on the *Holothurioidæ* of the Gulf of Manaar. In Ceylon Pearl Oyster Report. *Roy. Soc. Supp. Rep.* No. 5 (1903), 1, 181.
 SIMMONDS, V. *Commercial Products of the Sea*. New York (1879).
 MITSUKURI, K. Notes on the Habits and Life-History of *Stichopus japonicus* Selenka. *Annot. Zool. Jap.* (1903-1906), 5, 1.
 MITSUKURI, K. On Changes which are found with Advancing Age in the Calcareous Deposits of *Stichopus japonicus*, Selenka. *Ibid.* (1897), 1, 31.
 SLUITER, C. Fanna des Java-Meer. *Nat. Tijds. v. Ned. Indië* (1887), 47.
 SELENKA, E. *Zeit. f. wiss. Zool.* (1867), 17, 291.
 BELL, F. J. *Zoological Collection of H. M. S. 'Alert.'* (1884).
 EDWARDS, C. L. Variation, Development and Growth in *Holothuria floridana* Pourtalès and in *Holothuria atra* Jäger. *Biometrika* (1908), 6, 236-301.

ILLUSTRATIONS.

PLATE I. PHILIPPINE TREPANG.

- FIG. 1. The oe.
2. The gan sim.
3. The bark sim.
4. The moi whar che.
5. The hong che.

PLATE II. DIFFERENT VARIETIES OF "BARK SIM."

(Third grade Philippine Trepang.)

- FIG. 1. Small black trepang.
2. White ringed trepang.
3. Yellowish brown trepang.
4. Dark brown trepang.
5. Convoluted trepang.
6. Small convoluted trepang.

PLATE III. PHILIPPINE SHARK-FIN.

- FIG. 1. Dried shark-fin prepared for export.
2. The fin prepared for soup.

PLATE IV. THREE VARIETIES OF SEA TURTLES.

- FIG. 1. The loggerhead (*Thalassochelys caretta* Linn.).
2. Head of the loggerhead turtle.
3. The hawksbill turtle (*Chelone imbricata* Linn.).
4. Head of hawksbill turtle.
5. The green turtle (*Chelone mydas* Linn.).
6. Head of green turtle.

PLATE V. PHILIPPINE TORTOISE-SHELL.

- FIG. 1. Plate from the hawksbill turtle.
2. Section showing thickness of the above plate.
3. Plate from the green turtle.
4. Section showing thickness of the green turtle shell.

PLATE VI. COMBS MADE IN MANILA FROM PHILIPPINE TORTOISE-SHELL.

PLATE VII. PHILIPPINE WINDOW-SHELL.

- FIG. 1. Cross-section of shell near the adductor muscle showing actual width of shell including the animal.
2. Window shell, with growth of crustacean eggs near one margin.
3. Window shell opened and with the mantle of left side removed showing the organs in place.

PLATE VIII. ANATOMY OF THE WINDOW-SHELL MOLLUSK. *a*, Mantle; *b*, pallial fringe; *c*, gills; *d*, adductor muscle; *e*, liver; *f*, genital lobe; *g*, foot; *h*, anal funnel; *i*, labial palps; *j*, ventricle; *k*, auricle; *l*, kidneys.

PLATE IX. UTILIZING WINDOW SHELL.

- FIG. 1. Shell window in the new General Hospital, Manila.
 2. Screen made of window shell and red *narra* wood.

PLATE X. SHELL LAMPS.

- FIG. 1. Small porch-light made from window shell.
 2. Lantern light made from window shell.
 3. Reading lamp made of wood and window shell.
 4. The nautilus reading light. *a*, Base of red cement; *b*, stem of red coral-line; *c*, shade of chambered nautilus; *d*, electric wire to bulb which is hidden in nautilus shell.

PLATE XI. THE TOP SHELL.

- FIG. 1. Top shell (*Trochus niloticus* Linn.). Showing cuts for buttons in the partition walls.
 2. Side view of *Trochus niloticus* Linn.
 3. *Trochus niloticus* cut through the vertical plane.
 4. Top view of *Trochus niloticus* Linn.

PLATE XII. THE TURBON SHELL.

- FIG. 1. Turbon shell (*Turbo marmoratus* Linn.)
 2. Turbon shell (young).
 3. Turbon shell cut on a vertical plane.
 4. Side view of *Turbo marmoratus* Linn.



Fig. 1.

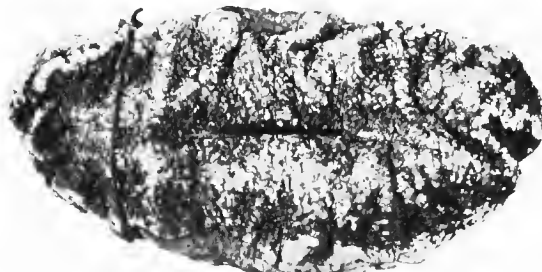

Fig. 2.

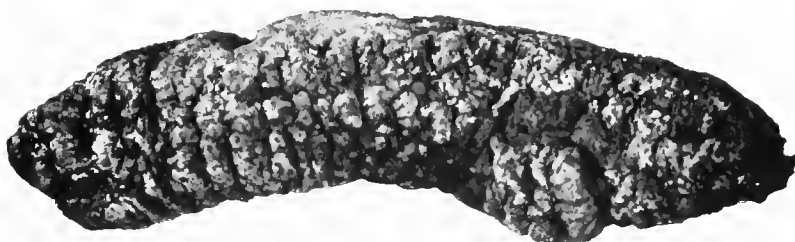

Fig. 3.

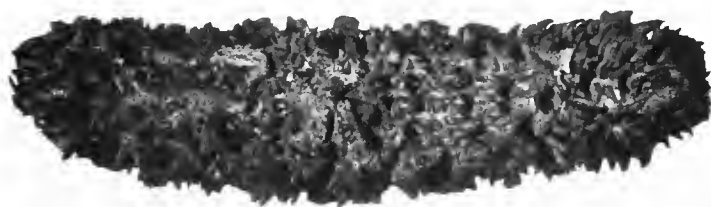

Fig. 4.

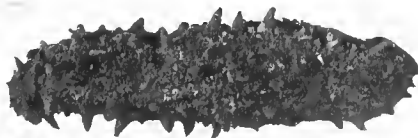

Fig. 5.

PLATE I.

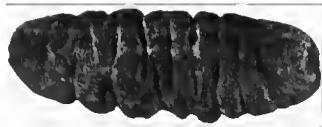

Fig. 1.

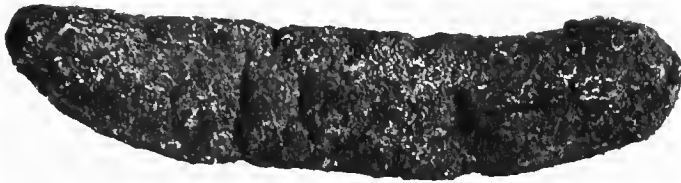

Fig. 2.



Fig. 3.

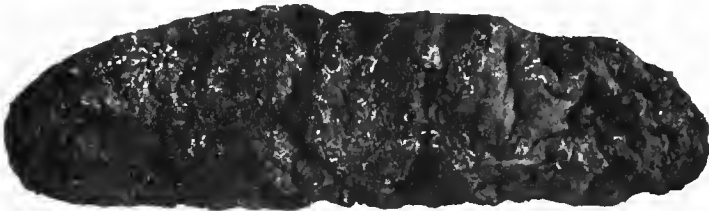

Fig. 4.

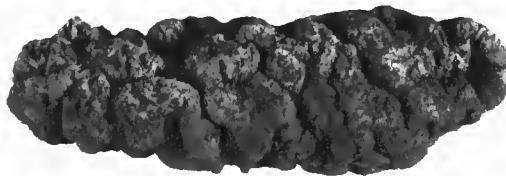

Fig. 5.

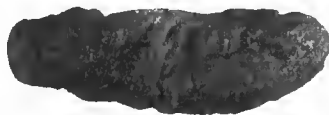

Fig. 6.



Fig. 1.



Fig. 2.



Fig. 1.



Fig. 2.

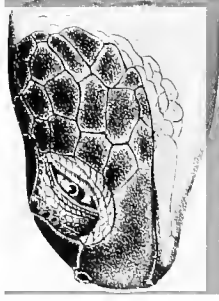

Fig. 3.

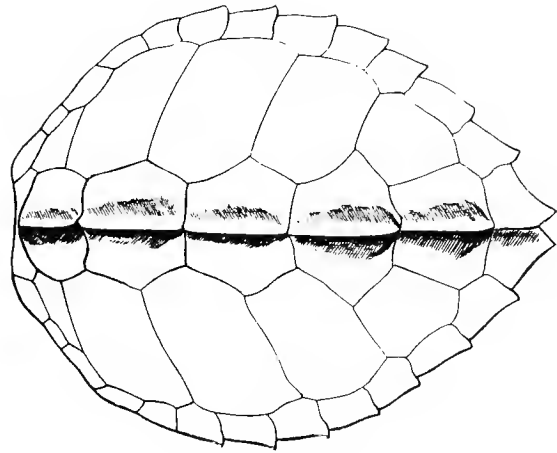

Fig. 4.

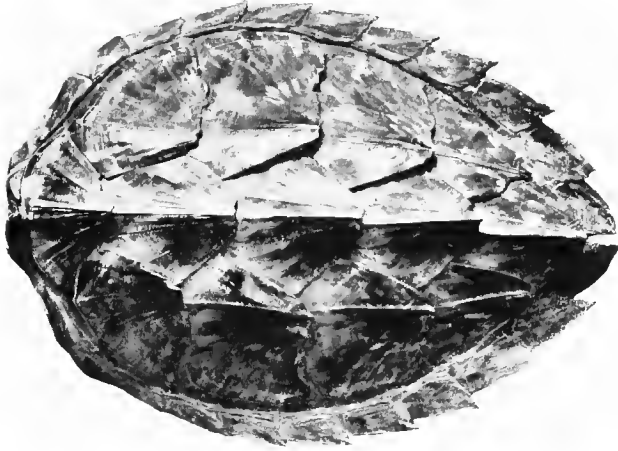

Fig. 5.



Fig. 6.

15 c m.



Fig. 1

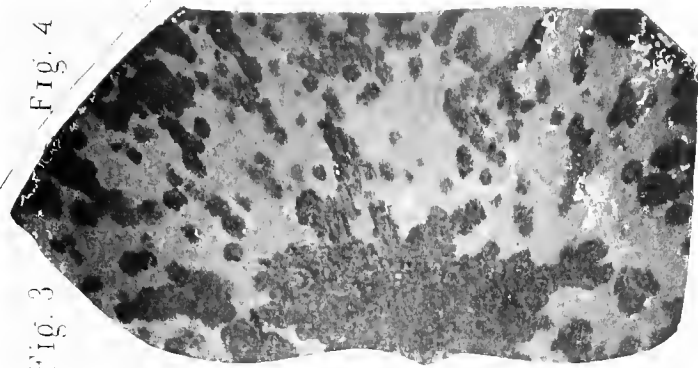

Fig. 3

Fig. 4

Fig. 2



Fig. 1.



Fig. 4.



Fig. 2.



Fig. 5.



Fig. 3.



Fig. 6.

15 cm.





Fig. 1

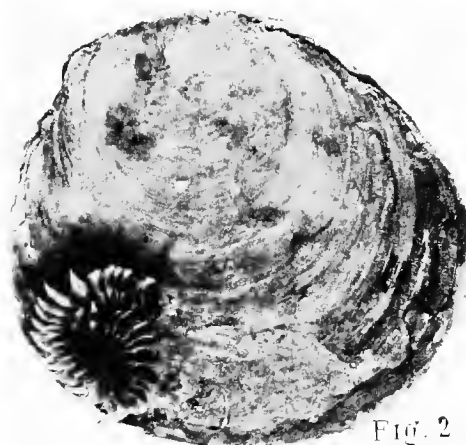

Fig. 2

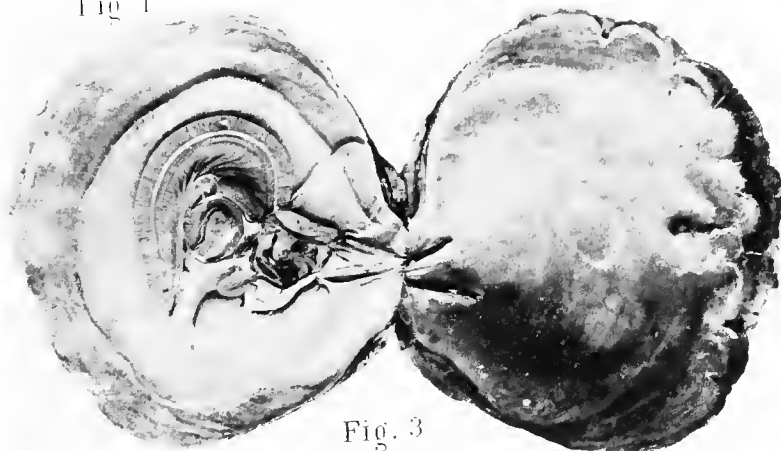
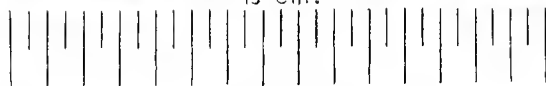

Fig. 3

15 cm.



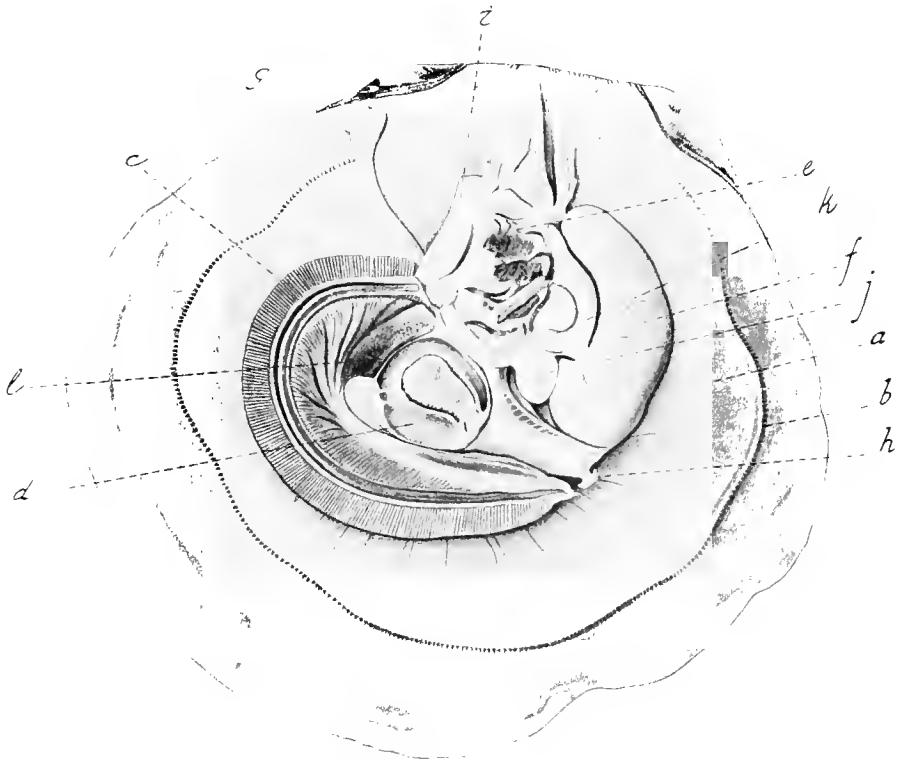

PLATE VIII.

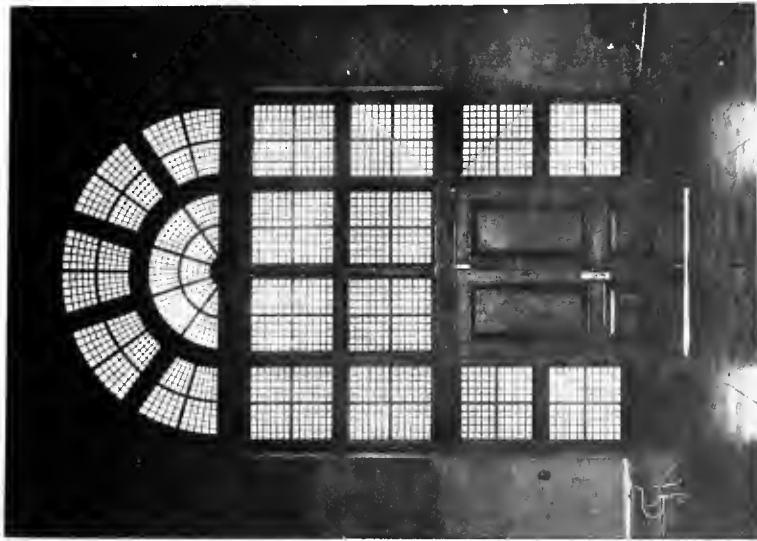

Fig. 1.

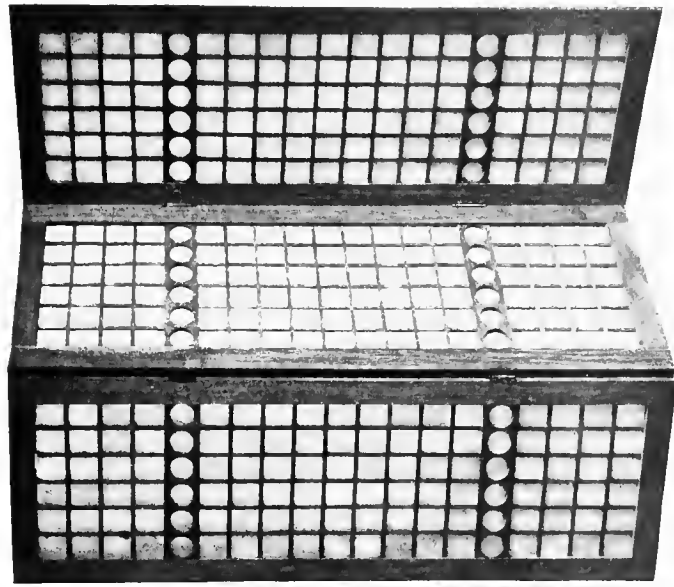

Fig. 2.

PLATE IX.



Fig. 1

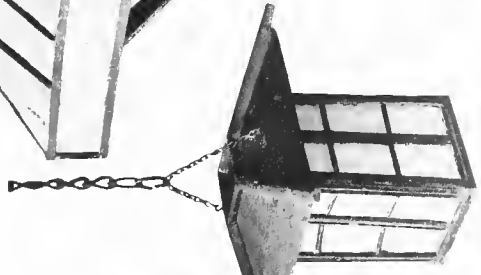

Fig. 2

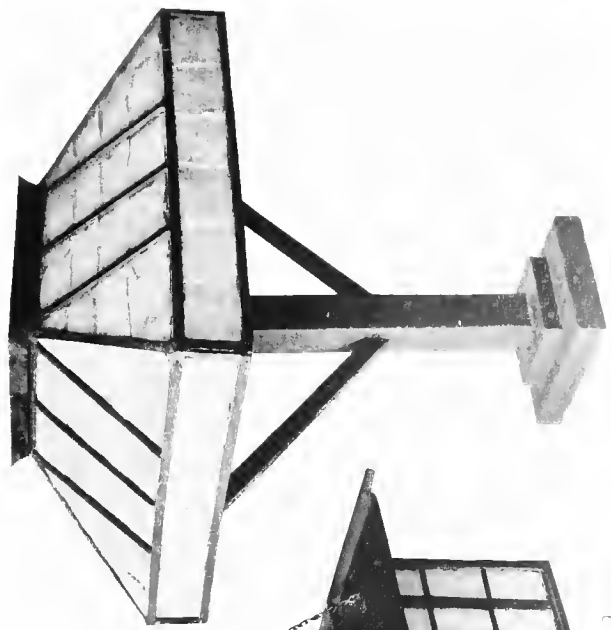

Fig. 3



Fig. 4.



Fig. 1.

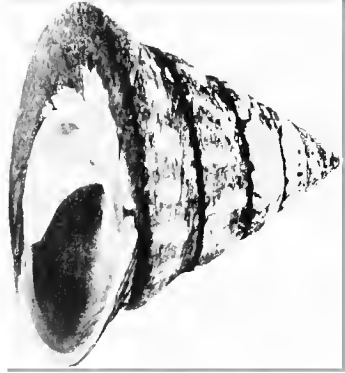

Fig. 2.

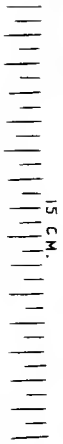

Fig. 3.

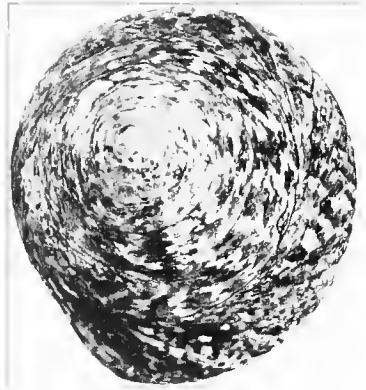

Fig. 4.

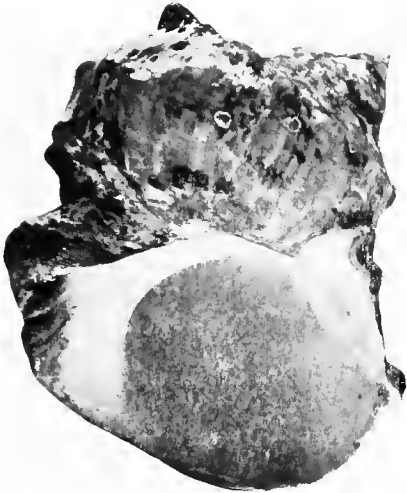

Fig. 1.



Fig. 2.



Fig. 3.

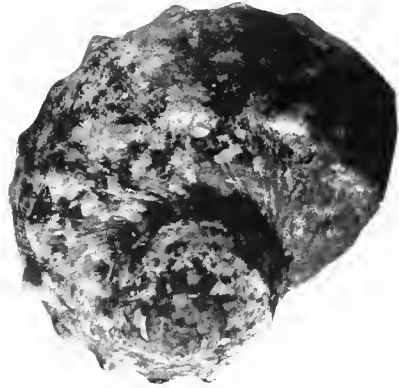

Fig. 4.



NOTES ON PHILIPPINE EDIBLE MOLLUSKS.

By ALVIN SEALE.

(From the Ichthyological Section, Biological Laboratory, Bureau of Science,
Manila, P. I.)

Mollusks¹ are daily sold in Manila markets, and no one seems to be able to give any definite information about them. Filipinos, especially of the laboring class, depend largely upon these shell fish for their daily food, and it is obviously important that we should make a careful study of the most important mollusks, in order that we may devise means of cultivating and continuing the supply, and especially there should be careful supervision of oyster beds, in order that they may be free from contamination.

The mollusks treated of in this paper are merely the common forms that are constantly used as food by the Filipinos. Any species listed may be purchased in the Manila markets at almost any time. A detailed list of all the mollusks used for food in the Philippines would include practically every species known to occur here.

OYSTERS.

Three species of edible oysters are found in the Philippines. These are *Ostrea orientalis* Ch., *O. palmipes* Saub., and *O. pyxidata* Reeve. All are known as *talaban* in Tagalog and *timer* in Ilocano. They form an important food supply in the Philippines, being found in almost all the islands. Near Manila large oyster beds occur on the tide flats at Malabon; and, in fact, almost all the *esteros* of Manila Bay have their quota of oysters.

¹ I do not claim to be a conchologist, and the identifications in this paper are the results of comparing specimens with identified species in the Quadras collection, and an examination of such literature as was available. Doubtless there are mistakes.

Large oyster beds are found along the south side of Manila Bay, where the cultivation of the mollusks receives considerable attention from the Filipinos. Almost all these beds are staked off as private claims, and a watchman is employed by the owners to prevent any serious thieving. In these beds small branches of bamboo are stuck in the mud as spat collectors. It is probable that these privately-controlled oyster beds have prevented the complete destruction of the Manila oyster industry by preserving the oysters until they are large enough to spawn. There is no law in force limiting the gathering of oysters.

The oysters found in the cultivated beds reach a length of from 12 to 14 centimeters, while shells 18 centimeters in length are not uncommon. Oyster beds of considerable extent and containing unusually well-flavored oysters are found in several localities in Palawan, especially in Malampaya Sound. No chart or survey of any kind has ever been made of the Philippine oyster beds except a preliminary inspection by the writer during the past year. They are well worth a thorough investigation, and no doubt the output could be greatly increased by proper cultural methods. An adaptation of the methods employed on the oyster farms at Arcachon, France,² could be inaugurated easily, especially in the oyster beds of Manila Bay.

The Manila Bay oyster is looked upon with considerable suspicion by the American population of this city, but, if fresh oysters are selected from the beds at a distance from the city and properly *cooked*, there is no reason why they should not be used as food.

In Manila markets, oysters sell for from 20 to 50 centavos³ per liter, very small ones can be bought for 1 centavo per dozen. It is estimated that about 50 liters are sold each day. The method of handling oysters in the local markets is to be deplored, and should speedily be remedied. They are usually brought to the market husked, placed on or in a tin box where the proposed buyers run their fingers over them. The seller also frequently dips in an unclean hand and gives them a generous mixing. There is no doubt that oysters are taken from certain of the *esteros* quite near the city, especially one draining the district of Tondo where there is every possibility of their being infected by sewage. The gathering and sale of such oysters in the market should be prohibited.

² Hornell, *Madras Fisheries Bull.* (1910), 1, 1 to 90, pls.

³ One peso (100 centavos) Philippine currency equals 50 cents United States currency.

The shell of the oyster is used in some parts of Luzon for the manufacture of lime, the price paid being 2 pesos per cubic meter. At Malabon there are piles of old shells of fully 100 cubic meters, which will serve to indicate the extent of the oyster industry at that place.

SURF CLAMS.

The *calumismis*, *Tapes striatus* Chem. (Plate I, fig. 4), is easily distinguished by the narrow black lines which form reticulations on the sides and straight lines on the margins. It measures about 7 centimeters across the widest diameter. It is found buried in the sand along the beach in shallow water, apparently much scattered, not growing in regular beds. These clams sell for from 7 to 12 centavos per dozen in the market. They are usually secured in the greatest numbers during October.

HARD SHELL CLAMS.

There are at least two species of clams included under the names *halaan*, *patayog*, and *cabia*. One, *Tapes literata* Linn. (Plate I, fig. 2), is brownish pink to white, with about three broad, radiating, white stripes from the back to the margin of the shell; these stripes have dark margins. This is by far the most abundant mollusk to be found in the Manila market, and can be secured at any time. In size it is about 6 centimeters across the greatest diameter. The clams are secured chiefly on the Pasay beach near Manila, usually at low tide. After a heavy storm, thousands are washed ashore and the beds are greatly damaged. They sell in the market for 40 centavos per hundred. They make excellent soup. Another clam, also called *halaan*, *Tapes virginæ* Linn. (Plate I, fig. 3), is in shape and general appearance much like the above, except that the stripes radiating from the beak to the margin of the shell are black or purple. This is a finely flavored clam, and commands the same price in the market as *T. literata* Linn.

SAND CLAM.

The *saropsarop* or *daroparpar*, *Circe undatina* Linn. (Plate I, fig. 5), is not so abundant as the *halaan*. It is also of less width between the valves; its longest diameter is about 6 centimeters. It is yellowish white with black lines across the hinge margin and above the beak. It is a good, clean food and sells in the market for 10 centavos per kilogram. It is found in salt water on practically all sandy beaches of the Philippines.

PHILIPPINE LITTLE-NECK CLAM.

The *lucan*, *Cyrena suborbicularis* Phil. (Plate I, fig. 6), next to the *halaan*, is perhaps the most important species in the Philippines. It forms a large percentage of the food of the poorer people of Manila. The *lucan* is quite abundant in most of the mud flats and *esteros* throughout the Islands, being a brackish-water species that burrows in the mud. In color it is uniform dark greenish; the epidermis is roughened or velvety to the touch. This species is the largest of the clams commonly sold in the markets, being from 6 to 9 centimeters across its greatest diameter. It sells for 6 centavos per kilogram. The *lucan* is wholesome, when fresh, and makes an excellent chowder.

SMALL GREEN CLAM.

The *tulla*, *Psammobia togata* Slesh. (Plate II, fig. 1), is found in abundance by sifting the black sand of the river mouths; it seems to extend into the fresh water. The shell is green, and about 3 centimeters in greatest diameter. This clam is excellent for soup. It sells for 7 centavos per kilogram in the Manila markets.

RIDGED SAND CLAM.

The *camotpusa*, *Circe gibbea* Lk. (Plate II, fig. 2), is a rather small clam, usually measuring about 5 to 6 centimeters across its widest diameter. It is characterized by the strong ridges on the posterior half of the shell. These ridges gradually diminish in size posteriorly. The color is white with about 3 angular black bands crossing the hinge. This clam is abundant about Manila on sandy beaches which are exposed at low tide. It has a fine flavor. The market price is 6 centavos per kilogram.

ROCK CLAM.

The *bototoy*, *Cardium dule* Linn. (Plate II, fig. 3), is a small clam usually about 5 centimeters across its greatest diameter; the width between the valves is about 5 centimeters. The shell is strongly and uniformly ridged, with the greenish fuzz of the epidermis filling the space between each ridge except on the beak, where it is usually worn off, thus exposing the white shell. This clam is found on reefs or among rocks in shallow water. It is regarded as a good food, and sells for 7 centavos per kilogram. It is very unusual, however, to see it offered for sale in any large quantity.

"BUTIL."

The *butil*, *Cryptogramma squamosa* Linn. (Plate II, fig. 4), is a clam 2 to 3 centimeters in its greatest diameter, found in the salt water on sandy beaches, throughout the Islands. The strongly-ribbed shell is white and brown. This small clam is a common article of food for the natives living near the sea. It sells for 3 centavos per hundred and makes excellent soup.

VENUS CLAM.

The *kanturi*, *Cardium donaciforme* Speng. (Plate II, fig. 6), is a white clam about 4 centimeters in length, common on sandy, salt-water beaches. It is of little value, and sells for 3 centavos per hundred.

MINUTE SAND CLAM.

The *alamis*, *Dorax radians* Lk. (Plate II, fig. 5), is a white or bluish clam, measuring about 3 centimeters across its greatest diameter. It is very abundant on sandy beaches in shallow salt water. It sells for 5 centavos per kilogram in the local markets.

WAVED VENUS CLAM.

The *morans*, *Venus alta* Saw. (Plate II, fig. 7), is a small clam, and is not found in sufficient quantities to be of much importance. It is interesting because of the curious sculpturing of its shell which resembles a minute model of the terraces on the hills of Japan or in the Igorot country of the Philippines.

DUCK-BILL CLAM.

The *lutos*, *Anatina truncata* Linn. (Plate I, fig. 9), is found in abundance in the sand and mud of the shallow water of Manila Bay. It is easily distinguished by the long thick "neck" protruding from the posterior portion of the shell. The color is uniformly white; the shell is very thin, and ranges in size up to 8 centimeters or more. It is regarded as a good food and sells for about 10 centavos per kilogram in the local markets.

SUNSET AND TELLEN SHELLS.

Paros. (Plate II, fig. 9.) There are about 14 species of the genus *Tellina* found in the Philippines, all of which are used as food. They are found on sandy or muddy shores, in the *esteros* or near the entrances to streams. They are usually beautiful shells, being a delicate purple with radiating stripes extending

from the beak to the margin of the shell. The usual size of our most abundant species is about 6 to 8 centimeters. Six species, *T. pellucida* Phil., *T. perplexa* Hem., *T. incerta* Desh., *T. capsoides* Lam., and *T. timorensis* Lam., are to be found in the local markets; they sell for 15 centavos per kilogram and make very good soup. The young are sometimes called *paros-parosan*. The *paros*, *Capsella elongata* Linn. (Plate II, fig. 8), is very similar to the above.

MUSSELS.

Tehong. There are about a dozen different species of mussels, family Mytilidæ, in the Philippines, representing at least three genera—*Mytilus*, the edible mussel; *Modiola*, the horse mussel; and *Lithodomus*, the rock-eaters. All are used as food in these Islands; perhaps the most abundant species is *Modiola matealfei* Hare. (Plate I, fig. 10.) They are found in the salt water usually attached to stones or piles. They are bluish or greenish, and from 4 to 13 centimeters in length. Their price in the local market is about 8 centavos per kilogram.

RAZOR CLAMS. FAMILY SOLENIDÆ.

There are three varieties of razor clams (*tikhan*) found in the Philippines. These are *Solenocurtus acurtidens* Brod. et Low., *Solen grandis* Dkr., and *Solen gracilis* Phil. (Plate II, fig. 10). The last-named species is the most abundant, being found on sandy or muddy beaches at very shallow depths. The shells are pale green, and measure about 7 to 8 centimeters in length by 1.5 centimeters in width. All are used as food and sell for 10 centavos per kilogram in the markets.

FRESH-WATER MUSSEL.

The *sulib*, *Anodonta tenuis* Lea (Plate I, fig. 8), is common in the Pasig River. The shell is greenish brown, smooth, and about 8 to 10 centimeters in length. The inside is a beautiful mother-of-pearl color; however, the shell is too thin for the manufacture of buttons, and I have never known of a pearl being found in one of them. They are highly regarded as food by the native inhabitants, and sell in the local market for 6 centavos per kilogram.

"BALAY." TONGUE CLAM.

These strangely-shaped shells, *Lingula anatina* Linn. (Plate I, fig. 11), are found in great abundance on Pasay beach, especially after a heavy storm, when they are secured by thou-

sands. They are used as food, but care should be exercised to get them perfectly fresh, as otherwise they are apt to produce gastric trouble. They sell in the local market for 6 centavos per hundred.

HORN SHELL.

The *bangongon*, *Telescopium telescopium* Linn. (Plate II, fig. 12), is a large, dark brown, cone-shaped shell, found in Manila Bay in salt or brackish water; usually on a mud bottom in shallow water. It is regarded as good food by the natives and frequently sold in the local market. There are at least 25 species of this family (Cerittindæ) found in the Philippines. Most of the individuals are very small. All are used as food. One species called *suso*, *Potomides sulcatus* Born (Plate II, fig. 13), is often sold in the local market at 5 centavos per kilogram. It is found in brackish water on a mud bottom. Perhaps the most abundant species is one called *susong-puti* or *bayongon*, *Cerithium rhizoporarum* A. D. (Plate II, fig. 11), a shell about 5 centimeters in length. It is yellowish with dark lines. These shells almost invariably have the tip broken off, and the tail of the animal protruding. They are sold in the local market for about 5 centavos per kilogram.

STROMBUS SHELLS.

The *palagsi*, *Strombus canarium* Linn. (Plate II, fig. 15), is quite common in Manila Bay. It prefers shallow water and a sandy bottom. It is used as food, selling for 6 centavos per kilogram in the local markets. There are at least 30 species of this family (Strombdæ) found in the Philippines.

WHELK.

The *alaunghuga*, *Melongena cochlidium* Linn. (Plate I, fig. 7), is 8 to 10 centimeters in length, deep chestnut in color, and is very common in Manila Bay. The animal is used for food.

BLEEDING TOOTH SHELLS.

The family Neritidæ (Plate II, fig. 14) is represented by a great number of species which are very abundant in the Philippines. The local name is *sihî*. All are small shells usually much striped or highly colored. The children of the natives gather quantities of these animals for food. The species most frequently seen in the local market is *Neritina pennota* Bonn. which is picked up from shallow water along almost any beach near Manila.

FRESH-WATER MOLLUSKS.

The *suso*, black river-snail (Plate II, fig. 16), and the *cohol*, green river-snail (Plate II, fig. 17), are apparently the only two fresh-water mollusks (except *Anodonta tenuis*) sold in the local markets; however, these are quite abundant and sell for about 6 centavos per kilogram.

In addition to the shells named, there are other species of mollusks which are only occasionally found in the Manila market, but which are of considerable importance as food in other islands of the Archipelago, such as the various species of *Murex* (Muricidæ), tritons (Tritonidæ), spindle shells (Tuscidæ), volutes (Volutidæ), olives (Olividæ), cones (Conidæ), helmet shells (Cassididæ), turbin shells (Turbanidæ), top shells (Trochidæ), and abolons (Haliotidæ). A complete list of these species together with an account of their habits, abundance, times of breeding, methods of reproduction, and notes regarding the possibilities of their culture would be a most desirable and useful work.

ILLUSTRATIONS.

(From photographs by Charles Martin.)

PLATE I.—PHILIPPINE EDIBLE MOLLUSKS.

- FIG. 1. *Talaban*, oyster (*Ostrea orientalis* Ch.).
2. *Halaan*, patayog, cabia, hard shell clam (*Tapes literata* Linn.).
3. *Halaan*, hard shell clam (*Tapes virginæ* Linn.).
4. *Calumismis*, surf clam (*Tapes striatus* Chem.).
5. *Saropsarop*, sand clam (*Circe undatina* Linn.).
6. *Lucan*, little-neck clam (*Cyrena suborbicularis* Phil.).
7. *Alaunghuga*, whelk (*Melongenella cochlidium* Linn.).
8. *Sulib*, fresh-water mussel (*Anodonta tenius* Lea).
9. *Lutos*, duck-bill clam (*Anatina truncata* Linn.).
10. *Tehong*, mussel (*Modiola metealfei* Hare.).
11. *Balay*, tongue clam (*Lingula anatina* Linn.).

PLATE II.—PHILIPPINE EDIBLE MOLLUSKS.

- FIG. 1. *Tulla*, small green clam (*Psammobia togata* Slesh.).
2. *Camotpusa*, ridged sand clam (*Circe gibbea* Lk.).
3. *Bototoy*, rock clam (*Cardium dule* Linn.).
4. *Butil*, lesser ridged clam (*Cryptogramma squamosa* Linn.).
5. *Alamis*, minute sand clam (*Dorax radians* Lk.).
6. *Kanturi*, venus clam (*Cardium donaciforme* Speng).
7. *Morans*, waved venus clam (*Venus alta* Saw.).
8. *Paros* (*Capsella elongata* L.).
9. *Paros*, sunset shell (*Tellina incerta* Desh.).
10. *Tikhan*, razor clam (*Solen gracilis* Phil.).
11. *Susong-puti*, horn shell (*Cerithium rhizoporarum* A. D.).
12. *Bangongon*, horn shell (*Telescopium telescopium* Linn.).
13. *Suso*, horn shell (*Potomides sulcatus* Born.).
14. *Sihi*, bleeding tooth shell (*Neritina pennota* Bonn.).
15. *Palagsi*, strombus shell (*Strombus canarium* Linn.).
16. *Suso*, black river-snail (*Helicidæ*).
17. *Cohol*, green river-snail (*Helicidæ*).

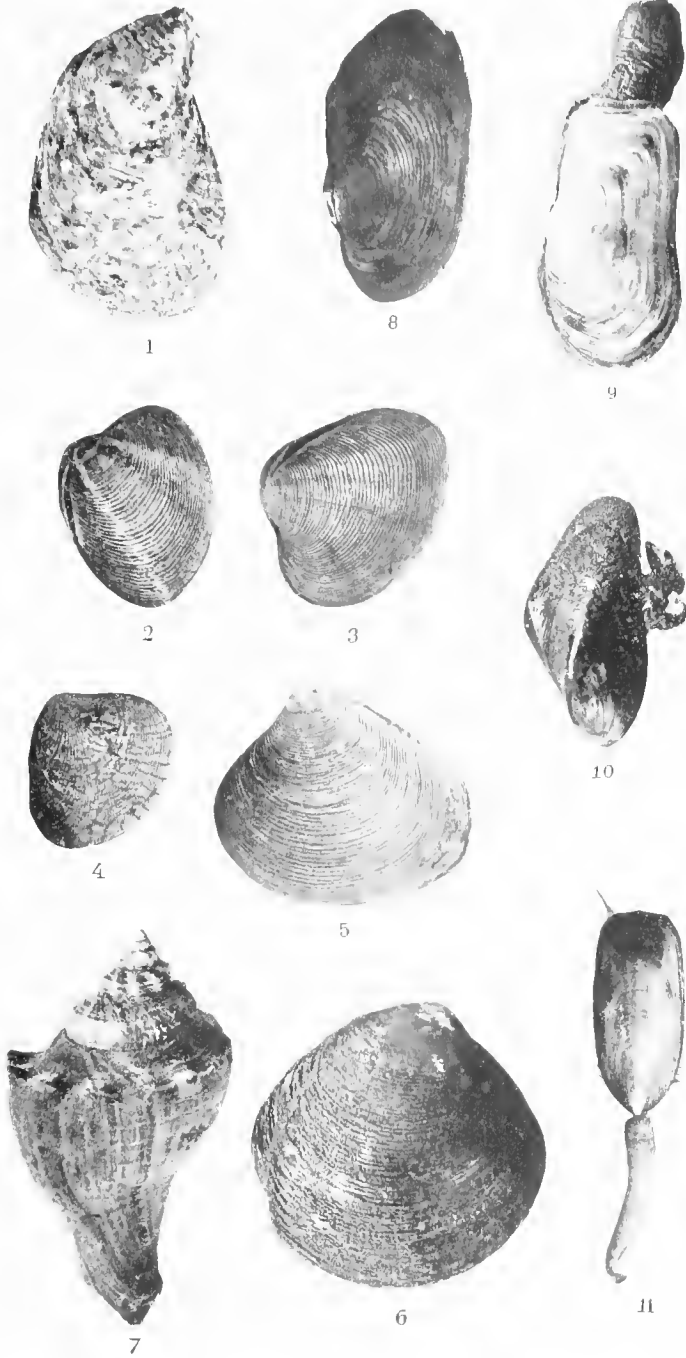

10-C.M.



PLATE I. PHILIPPINE EDIBLE MOLLUSKS.

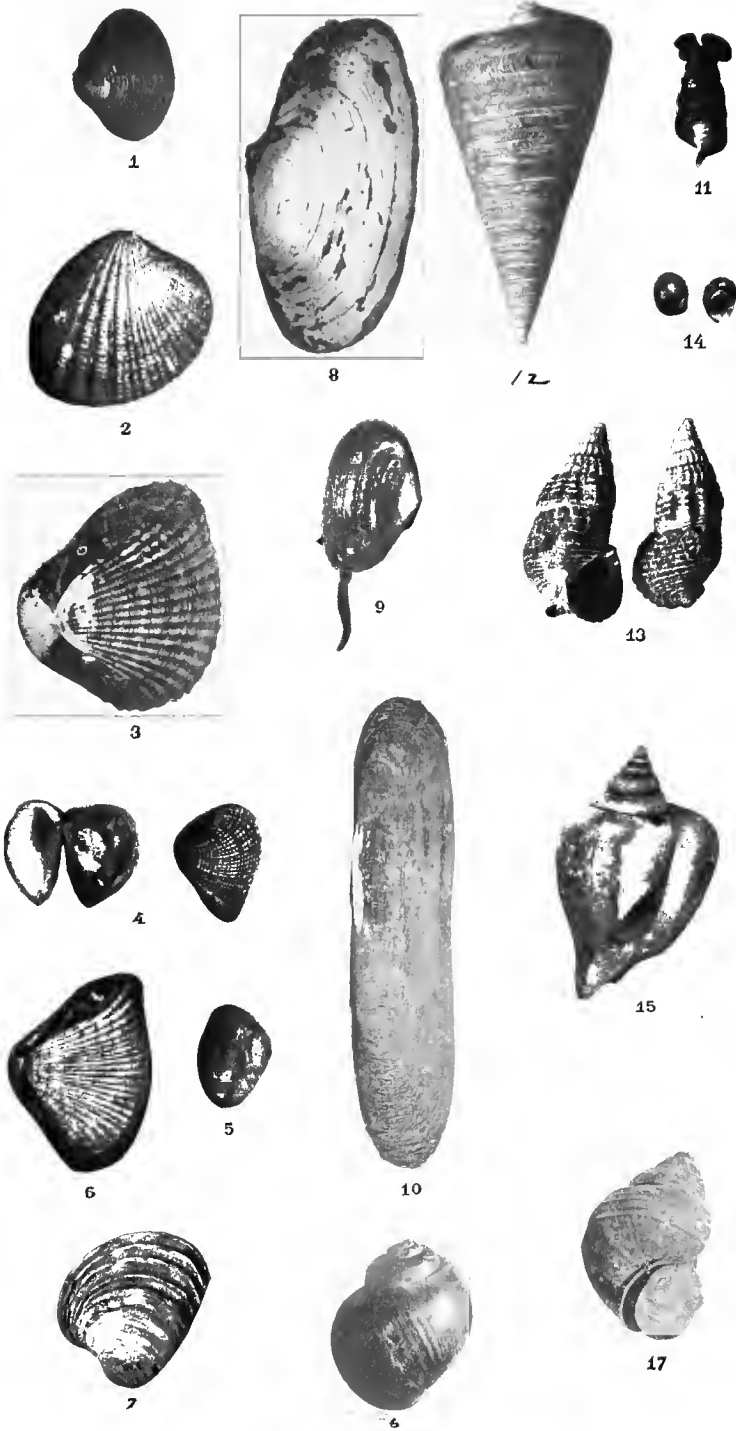

PLATE II. PHILIPPINE EDIBLE MOLLUSKS.

THE SUCCESSFUL TRANSFERENCE OF BLACK BASS TO
THE PHILIPPINE ISLANDS, WITH NOTES ON THE
TRANSPORTING OF LIVE FISH LONG
DISTANCES.

By ALVIN SEALE.

(From the Section of Fisheries, Biological Laboratory, Bureau of Science,
Manila, P. I.)

In April, 1907, I was authorized by the Insular Government to secure and bring to the Philippine Islands a shipment of live large-mouthed black bass [*Micropterus salmoides* (Lacépède)]. One hundred and seventy-five fingerlings, alive and in good condition, were secured at Folsom, California, upon the payment of a fee to the California State Fish Commission. Permission was secured from the United States Army Transport Service to ship the fish on the transport *Sherman*, and the success of this enterprise was due largely to the interest of both officers and men of that ship.

A small motor, driven by the electric current of the ship, was installed on the mess deck. An iron boiler, capacity 265 liters, was secured from the transport as an air reservoir, and a small air pump was connected with the boiler. A system of rubber pipes conducted the air from the boiler to the bottom of the cans in which the fish were carried and by working the motor only a short time sufficient air could be pumped into the reservoir to circulate through each can for four hours, the advantage of the reservoir being to maintain an even pressure and allow the air to cool. By means of a pipe, cold water could be kept running over the reservoir, which was also arranged so that ice could easily be packed around it.¹ The end of each of the rubber pipes leading

¹ A system of cold-water coils inside the reservoir would perhaps be a better, but more expensive method.

into the cans was drawn to a very minute point so that the air simply bubbled up through the water in a very small stream. (See fig. 1.)

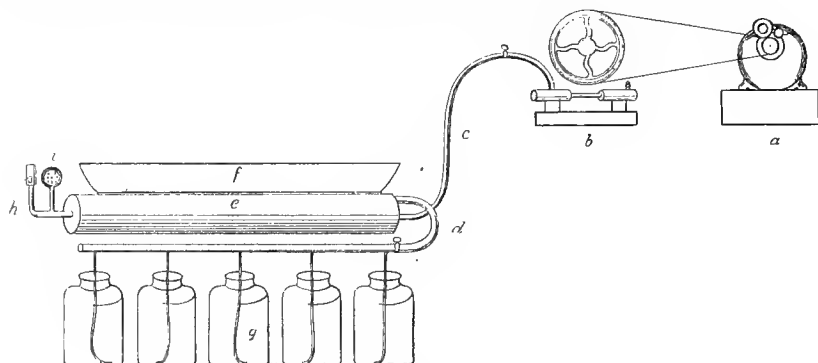

FIG. 1.—APPARATUS USED IN TRANSPORTING BLACK BASS TO THE PHILIPPINE ISLANDS.

When everything was ready, the fish were placed in six 38-liter milk cans which had previously been scalded and cleaned; about twenty-nine fish being allotted to each can. The temperature of the Spring Valley water in which the fish started was 11° ; that of the air, 16° ; and of the sea-water, 14° .

We sailed from San Francisco April 5, 1907. The next morning, while washing down decks, a sailor carelessly allowed some salt water to run into one can and fourteen of the fish therein were dead before we discovered the cause. However, not another fish was lost until we reached Honolulu. The second day out, food in the form of hard-boiled eggs, was offered the fish, but they would not eat. In the meantime the temperature of the water in the cans had been increased gradually to 21° , the air was 26° , and the sea water $25^{\circ}.5$.

When the transport coaled at Honolulu, despite all efforts to prevent it, more or less coal dust sifted into the cans, and six fish died during the two days' stay at that port. The remaining fish were alive when we reached Manila, May 4, twenty-eight days after starting from San Francisco.

When we were two days out from Honolulu the fish began to eat. They were fed on chopped crabs secured from the cold storage on the ship. They were given a small amount of food once a day, and they ate greedily. Shrimps were substituted occasionally for crabs.

A large pailful of water was taken from each can every day and replaced by one of fresh water from the ship's reservoir. On every third day each can, after the fish were poured into another, was thoroughly cleaned and scalded in order to prevent the growth of fungus; and every morning and evening the excreta and refuse in the bottom of the cans were siphoned out with a rubber pipe 18 millimeters in diameter. After leaving Honolulu the temperature of the water in

the cans was kept at about 21° until within two days of Manila, when it was increased gradually to 23°. When we arrived in Manila the temperature of the water in the cans was 23°, that of the air was 29°, and of the sea water 28°.

The fish had to be transported from Manila to Dagupan by rail, a distance of 193 kilometers, and thence 120 kilometers overland to Baguio, a mountain town in the Province of Benguet. This was the most difficult part of the trip, but it was accomplished in two days, with the loss of but one fish. The temperature of the water was lowered considerably during the last stages of the trip to Baguio, at which place the fish were planted in three distinct spots: One lot in the small lake near the Hotel Pines, another in a deep pool in the Trinidad River, and a third in the large Trinidad Lake. (See diagram, fig. No. 2.)

In December, 1909, I visited the places where these fish had been planted, and found that those placed in the small lake near the Hotel Pines had escaped early in the year; nothing was seen or heard of those planted in Trinidad River, but a tale was current of the capture of some large fish by the natives. The bass planted in Trinidad Lake had flourished and multiplied exceedingly well. A short trial with a fly gave sufficient proof that the lake was well stocked, as not only one of the original fish, but also one of the offspring was hooked; the latter (see Plate I) was 190 millimeters long and the parent fish was almost twice this length.

During February of the past year the small artificial lake in front of the Hotel Pines at Baguio was transformed into a good spawning pond by raising its walls, putting in concrete gates, and adding several loads of gravel for spawning beds. Twelve large bass caught in Trinidad Lake with a fly hook were transferred to this breeding pond on February 23. By May 4 they had spawned and there were hundreds of young bass in the pond, many of these have since been planted in other places, and some large bass were placed in Cayman Lake at Los Baños, Laguna Province. It is now an assured fact that people who live far inland may have this most desirable addition to their diet, and for those who care for it there is the pleasure and excitement of angling for this noble game fish.

TRANSFERRING MOSQUITO-EATING FISH.

In the year 1905 I was authorized by the Government of the Hawaiian Islands to secure and bring to Honolulu a shipment of live top minnows, *Fundulus heteroclitus* (Linn.), *Gambusia affinis* (B. & G.) and *Mallinencia latipinna* La S. to assist in ridding that place of the pest of mosquitoes. These fishes belong to the family *Poeciliidae* and are found in the southern United States. They feed almost exclusively on the eggs and young of the mosquito. Fifteen hundred dollars United States currency was

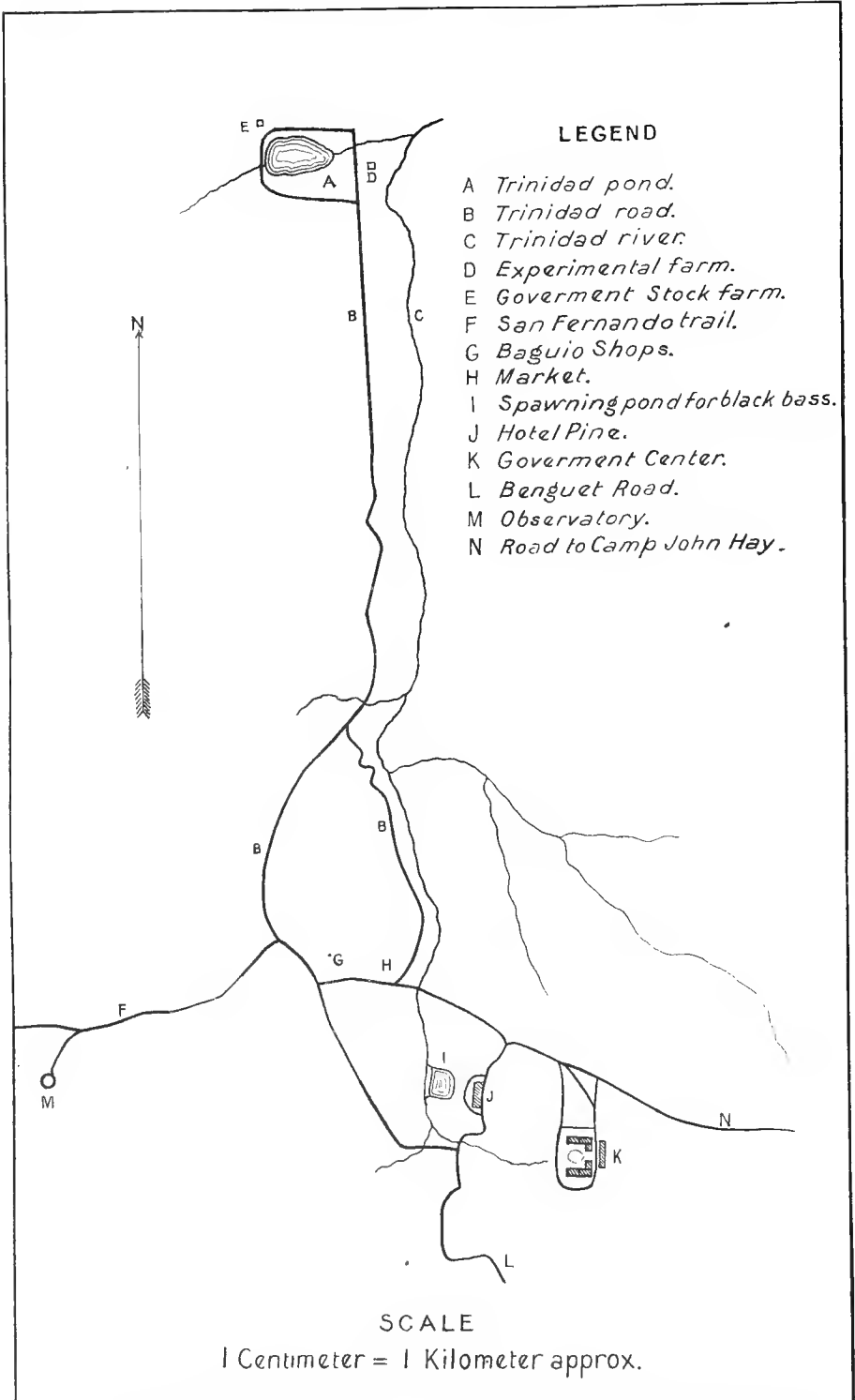

FIG. 2.—DIAGRAM OF BAGUIO AND VICINITY, SHOWING LOCATION OF BASS PONDS.

provided by the Territorial legislature for this venture. The fish were secured at Seabrook, Texas, and two weeks were spent in experimenting on conditions under which they could be transported through this long distance. It was proved that they could not successfully be iced and carried at a low temperature, a method which is usually most satisfactory, but that at a temperature of 23° they could be kept in ordinary milk cans with but little trouble.

On September 4, 1905, I left Seabrook, Texas, for Honolulu, with six 38-liter milk cans and 75 top minnows in each can. By adhering to the following routine, but little difficulty was experienced in the transportation of the fish. At 8 o'clock in the morning the fish were fed sparingly on prepared fish food, finely ground liver or hard-boiled eggs;² at 9.30 half the water in each can was siphoned from the bottom, thus cleaning out the can and removing all uneaten food and excrement, and an equal amount of fresh water was added. At noon, all the cans were aerated by means of a large bicycle pump, a sponge being tied over the hose to separate the air into fine particles. At 4 o'clock in the afternoon 8 liters of water were siphoned from the bottom of the cans and fresh water added; and late in the evening the cans were again aerated. At each place where the water was changed it was first tested by placing two fresh fish in a bucket containing the new water at the proper temperature.

Twelve fish died between Galveston, Texas, and San Francisco, California, and fifteen between San Francisco and Honolulu. I landed in Honolulu from the steamship *Alameda* on September 15, 1905, after a twelve days' trip from Texas. Only 27 of the 450 fish were lost. They were in good condition when they arrived and were at once transplanted to small breeding ponds which had already been prepared for them, and they at once began work on the mosquito larvæ. There was but 0.56° difference between the natural temperature of the water at Seabrook and that at Honolulu.

At the present time, these fish have multiplied to such an extent that there are now several hundred thousand of them and they have been distributed to all the large islands and have very perceptibly diminished the mosquito pest, as is evidence by the following statement quoted from a letter from the governor of Hawaii written on May 23, 1910:

* * * I am glad to state that top minnows have been a decided success here. They were introduced, I believe, about six years or so ago, and have been placed in all the different districts of this island and in a number of places on the other islands. They have multiplied rapidly and the streams and ponds about Honolulu are full of them. I understand that in some cases where ponds have swarmed with the larvæ of mosquitoes, the top minnows have entirely cleaned them out within a few days after their introduction. At Waimanalo, on this island, where mosquitoes were usually plentiful, there are now scarcely

² It would be better to feed every third day.

any, owing to the introduction of this fish. One difficulty has been experienced, and that is that the natives and Chinese catch them in considerable quantities to eat and for bait.

As a result of my experience in carrying live fish great distances, I have found that there are three important things which must not be lost sight of. *First, cleanliness.* All cans in which the fish are transported must be cleaned thoroughly at least every third day with hot water; this prevents the growth of fungus. The water in the cans must always be pure and the excrement and uneaten food must be siphoned out each day. The fish must never be touched with the hands. *Second, temperature.* Above all else a sudden change in the temperature of the water must be avoided; it must never be changed all at once, but the fresh water must gradually be mixed with that in which the fish already are. It should take at least several hours to lower the temperature one or even one-half degree. *Third, vigilance.* Success in this work is attained only at the cost of eternal vigilance. When the fish are suffering from any cause whatsoever, they come to the top of the can continually and only by constant care and watching can the proper remedy be learned.

ILLUSTRATIONS.

PLATE I.

Large-mounted black bass [*Micropterus salmoides* (Lacépède)] from Trinidad Lake, Baguio, Benguet.

TEXT FIGURES.

FIG. 1. Apparatus used in transporting black bass to the Philippine Islands.

- (a) Three-fourth horsepower electric motor.
- (b) Air pump.
- (c) Air supplying pipe to reservoir.
- (d) Air supplying pipe from reservoir.
- (e) 265-liter air reservoir (old iron hot-water boiler).
- (f) Box for holding ice.
- (g) 38-liter milk-can containing fish.
- (h) Safety valve.
- (i) Pressure indicator.

FIG. 2. Diagram of Baguio and vicinity, showing location of bass ponds.

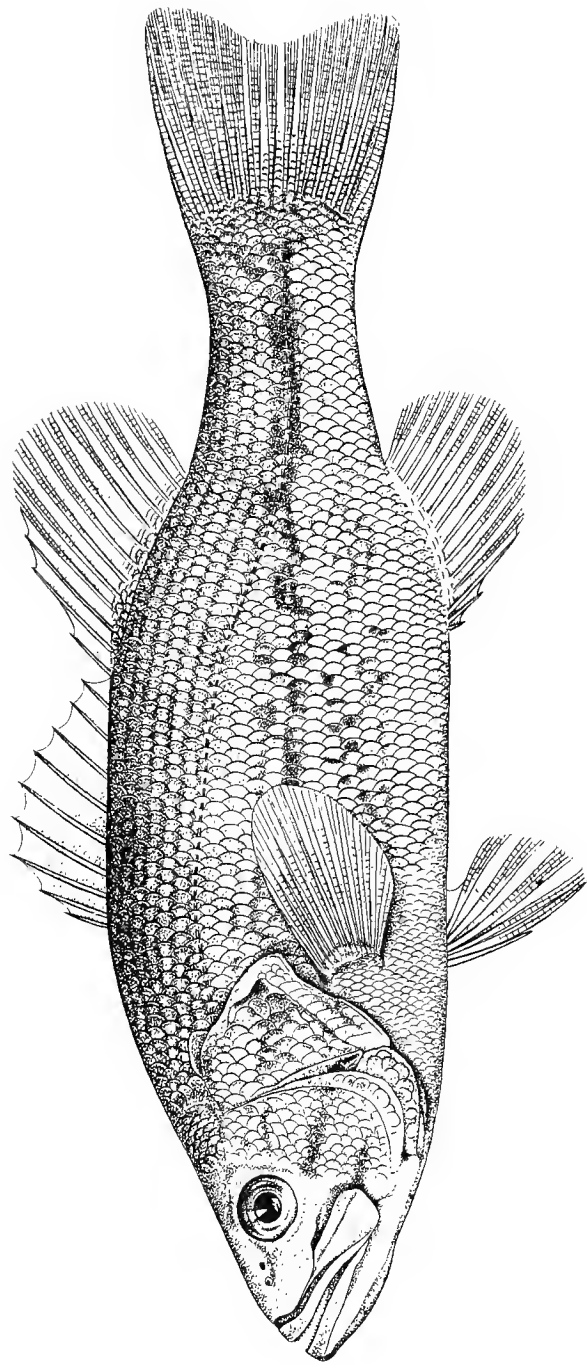

EDITORIAL.

SOME POISONOUS PHILIPPINE FISHES.

The following letters serve to call our attention to the fact that death resulting from eating certain species of fish is of occasional occurrence in the Philippine Islands.

SIR: I have the honor to send you a bottle containing a small specimen of the poisonous fish known among the Moros as *tinga-tinga* and among the Filipinos as *botete*. This is the first specimen I have been able to get since the last case of poisoning which resulted in the death of a little girl and the narrow escape of several members of the family. The first effect after eating the fish is a dizziness and sickness at the stomach, but if the latter does not occur at once the victim, if he yields to his inclination and lies down and sleeps, will soon be aroused, vomit and soon expires. There have been so many fatalities among the Moros on account of eating the *tinga-tinga* that the people are careful. They say that if the head of the fish is cut off at once and the entrails removed the fish may be cooked and eaten.

In the case of the fatality to which reference is made, the woman who cooked the fish knew of its dangerous character, but thought she had taken all necessary precautions. The little girl, a visitor in the house, ate of the fish, was seized with the dizziness, and leaving the meal, lay down and slept a short time, when she was seized with an attack of vomiting and died in a few moments. All members of the family were seized with the well-known effects and vomited all night. These eventually recovered.

We have another poisonous fish in these waters and its use is as equally dangerous as the *tinga-tinga*. It is called in the Moro "loco."

(Signed.) SAMUEL D. CRAWFORD,
Governor of Basilan.

SIR: I have the honor to inform you that at the sitio of Kamayá in this municipality, several cases of poisoning caused by a fish commonly known as "*botete*" have occurred, the victims being Roque Noruega, Lorenzo Noruega, Genoveva Noruega, Ciriaco Noruega, Petra Sales, Fernando Noruega, Matias Noruega, Proceso Useñas, Antonio Tamora, Amada Useñas, Pomposa Useñas, Carmen Useñas, and Francisco Villarín. These persons, without any thought of evil, ate of the fish mentioned yesterday

afternoon between 5 and 6 o'clock, and from the effects thereof the youth Fernando Noruega died last night between 11 and 12, and the boy Matias Noruega this afternoon between 2 and 3 o'clock. Petra Sales is in a very serious condition.

All survivors have been given the necessary aid and treatment by the physician in charge of the quarantine station.

(Signed.) VALENTIN SEMILLA,
Municipal President.

DECEMBER 11, 1911.

The fish called *tinga-tinga* or *botete* in the above communications is the black-spotted puffer, *Spheroides sceleratus* (Forster) (Fig. 1). It belongs to the family Tetraodontidæ. There are 14 species of this family found in the Philippines; all of them

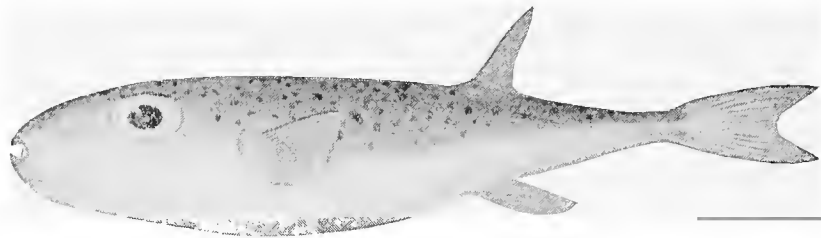

FIG. 1. "Tinga-tinga" or "botete."

are supposed to secrete a specific poisonous alkaloid which gives rise to gastric trouble of a very serious nature when taken into the stomach of man.

These fishes are common all over the tropical Pacific; they are usually found in shallow water, and under ordinary conditions are sluggish in their movements. When one is captured, it distends its stomach until it resembles a ball. Their color is usually white below, with black dots, stripes, or bands on the sides and back. In length they range from 2 to 20 centimeters.

The fish called "loco" in the first letter belongs to the family Diodontidæ, or porcupine fish, called *botiting laot* in Tagalog. There are 3 species of this family found in Philippine waters, all believed to be poisonous.

In addition to the above, there are 7 species of Balistidæ, or trigger fishes, called *papaco*, and 10 species of Monacanthidæ, or file fishes, called *pacol*, which should be regarded with grave suspicion.

There is very little danger of an American or European eating any of these fishes, as their appearance and smell are offensive, and they are too small to be desirable for the table.

Nearly all the natives of the Islands know that these fishes are poisonous, but either because of the peculiar flavor, or because of the ease with which they are caught, the fish are often eaten, and usually with deplorable results.

The treatment of a person who has eaten poisonous fish is promptly to empty the stomach of the patient with an emetic, such as tepid salt water or mustard. Then a stimulant such as whisky or *vino* should be given. In case of collapse, artificial breathing should be employed.

ALVIN SEALE.

DESCRIPTIONS OF FOUR NEW SPECIES OF FISHES FROM
BANTAYAN ISLAND, PHILIPPINE ARCHIPELAGO.

By ALVIN SEALE.

(From the Section of Fisheries, Biological Laboratory, Bureau of Science, Manila,
P. I.)

Chaetodon carens Seale, sp. nov.

Head 3.10; depth 1.75; eye 2.80 in head; snout 3.25; interorbital 3; dorsal XIII, 21; anal III, 17; scales 7-38-20, the scales are larger on middle of sides; maxillary 4.50 in head, its distal end under nostril. Body slightly more elongate than is usual in this genus, strongly compressed, length of caudal peduncle 1.10 in its depth. Head of moderate size, characterized by the large eye, and short pointed snout; profile from tip of snout to origin of dorsal forms an angle of about 45°, the line from tip of snout to nuchal region is straight, slightly concave on the shoulder; the depth of the fish at origin of dorsal 1.75 in length to end of vertebra; origin of soft dorsal and origin of anal about on line. Mouth small; teeth brush-like in several rows, slightly projecting; gill openings wide, being carried forward to below eye; nostrils small, close together, in front of eye; gill rakers few, short and weak; dorsal spines rather long and saber-like, the third, fourth, and fifth the longest, the fourth 1.30 in head; dorsal and anal rounded; the origin of anal midway between middle of opercle and end of caudal vertebra; the second anal spine is the strongest and equal in length to the third spine, its length 1.50 in head; origin of ventrals midway between origin of anal and middle of cheeks, its tip extending slightly past anal pore; pectorals 1.10 in head.

Color in alcohol sepia-brown; no ocular band; nuchal region and top of head slightly darker, being a clove-brown; a wide black band on middle of spinous dorsal extends back and occupies almost the entire anal, except a narrow white tip and a small portion at the base of the anal spines; caudal yellow with a slight dusky wash on its posterior third; ventral brown with some indistinct yellowish blotches; pectorals yellowish white.

Type, No. 6173 in collection of Bureau of Science, from Bantayan Island, P. I. Length, 108 millimeters.

Chaetodon adiergastos Seale, sp. nov.

Head 3; depth at middle of dorsal 1.30; eye 3 in head; snout 3; interorbital 3; dorsal XII, 26; anal III, 21; scales 4-31-14; maxillary 4, its tip below nostril. Body short, deep, and strongly compressed; scales large on sides, small on head, soft dorsal, anal, and base of caudal. Head small, the profile steep, concave; snout small and pointed, its length about equal to width of eye; mouth small; teeth setiform, in several rows in each jaw, somewhat curved and projecting; nostrils small, close together and in front of eye; interorbital space slightly convex; gill openings large, being carried forward to below middle of eye; gill rakers few, short and weak; dorsal spines short and strong, the middle ones the longest, about 1.80 in head; soft dorsal rounded, similar to anal; origin of anal midway between anterior margin of eye and tip of caudal, the second anal spine strong and equal in length to the third which is slim; caudal truncate, its length 1.75 in head; ventrals midway between middle of cheek and origin of anal, the tip extending beyond the anal pore, the axil with an elongate scale; pectorals slightly less than head. Lateral line arched and high, ending at posterior angle of dorsal.

Color in alcohol is yellowish with numerous oblique brown lines extending down and forward over the entire side, each line marking the center of a row of scales, a jet-black ocular band of greater width than eye, the band not uniting above with its fellow, and its lower margin ending on the suboperculum. This band is very distinct and sharply defined, and is without marginal white borders, although the opercles and chin are almost white. On the shoulder midway between the first dorsal spine and the interorbital space is a small black saddle, not connected with the ocular band. Snout yellow, unmarked; soft dorsal and anal brown, with dark tips which have a rather narrow band across the posterior yellowish white area, basal third of fin brown; ventrals yellowish with some very indistinct darker blotches; pectorals yellowish.

Type, No. 5800 in collection of Bureau of Science, from Bantayan Island, P. I. Length, 116 millimeters. Also cotype No. 5791, length 111 millimeters.

This species is related to *C. flavirostris* Günther, but lacks the wide, dusky band from dorsal to anal which characterizes that species. Our species is more distinctly striped than *C. xanthurius* Bleeker. It differs also in having a wide ocular band and in being distinctly striped, the stripes running obliquely forward over the entire sides. It also has no "broad yellow band occupying the posterior part of the body," and neither the ocular band nor the saddle is bordered by a white line.

Amblygobius insignis Seale, sp. nov.

Head 3.60; depth 4.70; eye 4 in head; snout 4.10; maxillary 2.50; interorbital less than width of pupil; dorsal VI, 13; anal 13; scales 60-70 in lateral series. Head naked; no barbules; no serri. Teeth in two

or more rows with an outer row of enlarged curved canines in the anterior part of each jaw. Tongue rounded, not adnate to floor of mouth. Head rounded, angle of mouth under anterior third of eye.

Body oblong compressed; depth of caudal peduncle 2.30 in head; its length 1.75 in head. No hair-like filaments at upper part of pectorals. Origin of dorsal fin midway between tip of snout and base of sixth dorsal ray, the second, third and fourth dorsal spines slightly elongate, the second spine the longest, being almost equal to head; anal similar to soft dorsal, its longest ray 2.10 in head, its origin under the second ray of soft dorsal, its posterior rays not reaching to caudal; caudal rounded, 1.10 in head; ventrals fully united, their origin midway between tip of snout and origin of anal, their length 1.25 in head, their tips not reaching to anal opening; pectorals 1.10 in head.

The color markings of this species are very striking and characteristic, the posterior half of the body being covered with oblique bands of brown alternating with yellowish. These run downward and backward at an angle of about 70° ; the yellow bands are slightly less in width; below the spinous dorsal they are broken up. The coloring of the belly is lighter, with about six narrow white lines which extend entirely around the belly and nearly to the median line on sides. Two oblique narrow dusky lines extend forward across cheeks and around the throat, the anterior one just back of angle of jaw; some small black dots scattered over head and shoulders; about three very indistinct darker bands over nuchal region. Spinous dorsal yellowish with a dusky stripe near the margin and some dusky punctulations at base. soft dorsal with the alternating brown and yellowish bands of body extending into the fin and forming the markings; caudal grayish with indistinct yellowish vertical lines; some black dots on upper portion of fin; anal yellowish, the distal half black in which color are small scattered yellow dots; ventrals grayish, with a dusky wash on the posterior portion of the interior; pectorals yellowish, slightly darker at base.

Type, No. 5779 in collection of Bureau of Science, from Bantayan Island, P. I. Length, 58 millimeters. One specimen.

Amia griffini Seale, sp. nov.

Head 2.50 (including opercular flap); depth 2.25; eye 3.10 in head; snout 4.50; interorbital space 4; dorsal VII, 19; anal II, 8; scales 2-26-7; lateral line complete; two rows of scales on cheeks; posterior limb only of preopercle serrated. Mouth large, oblique, the maxillary ending under middle of eye; minute teeth in jaws, vomer and palatines; gill rakers rather long and strong, 15 on lower arch; gill openings large, being carried forward to below anterior third of eye.

Body oblong, compressed, the depth appearing greater than is usual in members of this genus; depth of caudal peduncle 1.25 in its length. Head deep and pointed, the profile almost straight; fins long, the soft

dorsal with the three anterior rays elongate, greater than length of head; first dorsal spine very minute, the second 1.30 in eye, the third and fourth the longest, 1.85 in head; origin of anal midway between base of caudal and posterior margin of eye, its second spine equal to width of orbit, its longest ray 1.75 in head; origin of ventrals on a line with origin of first dorsal, its rays reaching anal spines, its length 1.30 in head; pectorals 1.50 in head.

General color in alcohol mars-brown; yellow on belly; margins of the scales on sides above belly are shaded with minute brown dots. There is a very indistinct indication of five or six narrow dark stripes on the middle of the rows of scales anteriorly, scarcely to be distinguished in the cotypes; no marking on head; a brownish blotch on base of pectorals; a small black dot on base of caudal just above the lateral line, one of the cotypes is without dot. Dorsal fin grayish, the spinous dorsal slightly darker on margin; caudal yellowish, the margin grayish; anal yellowish at base shading into grayish on outer half; ventrals yellowish, their margins grayish; pectorals yellowish.

Type, No. 5701 in collection Bureau of Science, from Bantayan Island, P. I. Length, 125 millimeters. Cotypes, Nos. 5696 and 5698, from same locality. Length, 124 and 135 millimeters.

Named in honor of Dr. L. E. Griffin, the collector.

ILLUSTRATIONS.

PLATE I.

- FIG. 1. *Chatodon carcus* Seale.
2. *Chatodon adiergastos* Seale.

PLATE II.

- FIG. 1. *Amblygobius insignis* Seale.
2. *Amia griffini* Seale.

96836—3

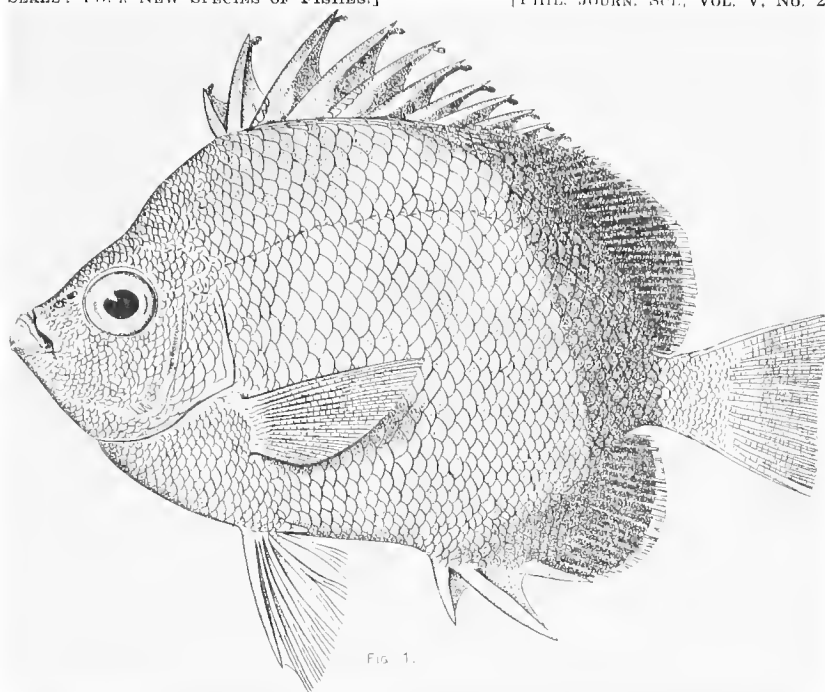

FIG. 1.

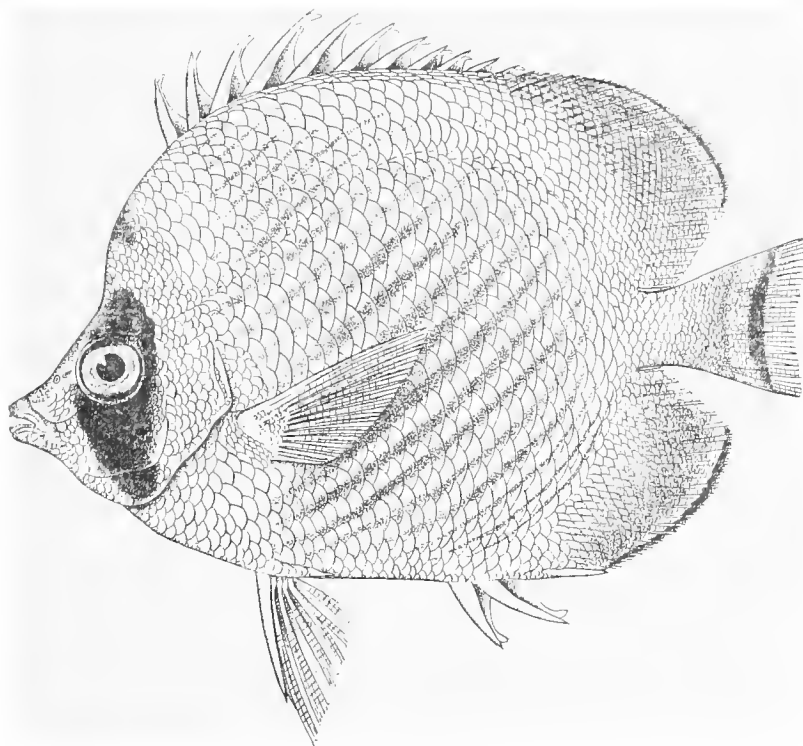

FIG. 2.

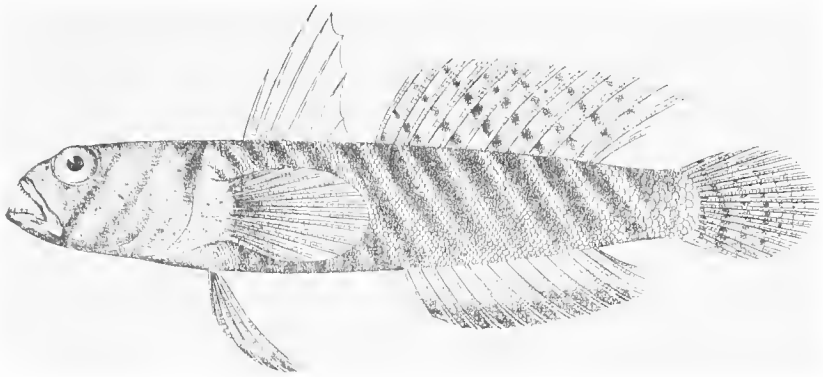

FIG. 1.

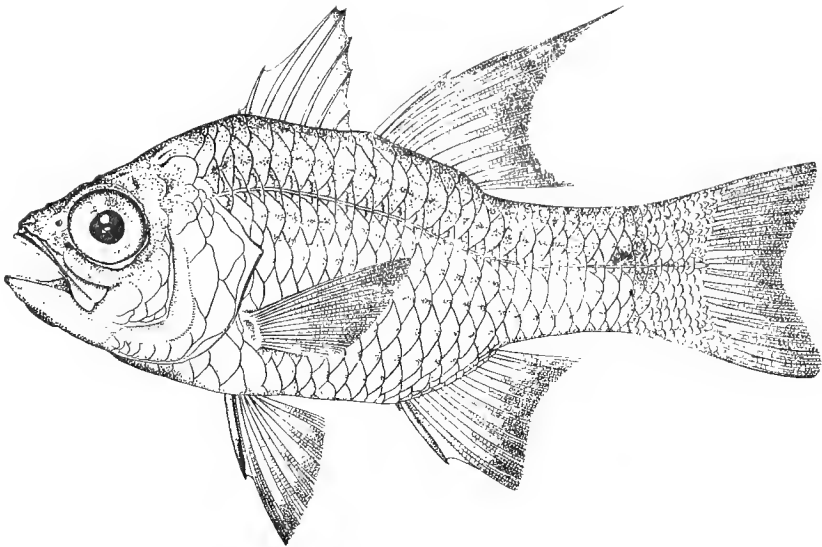

FIG. 2.

PLATE II.

FISHES OF BORNEO, WITH DESCRIPTIONS OF FOUR
NEW SPECIES.

By ALVIN SEALE.

(From the Section of Fisheries, Biological Laboratory, Bureau of Science,
Manila, P. I.)

The following collection of fishes was secured by me at Sandakan, British North Borneo, February 10 to 14, 1908. Of the one hundred and seventeen species, ninety-one were common to Borneo and the Philippines. Twenty-six only were recorded from Borneo and not from the Philippines. The method of measurement is the same as that used by Jordan and Evermann.¹ The color markings recorded are all from specimens which have been two years in alcohol.

Family CARCHARIIDÆ. Sharks.

Charcharias borneensis Seale, sp. nov. Plate I.

Head 4; depth 5.1; eye 6.50 in head; snout but slightly less than interorbital; middle of eye exactly midway between tip of snout and second gill arch; no spicules; nostrils considerably nearer mouth than to tip of snout; length of under jaw 1.60 in snout; width of mouth at angle 1.25 in snout; five gill arches, the posterior ones above base of pectorals. Teeth all oblique in two rows at least $\frac{2\frac{2}{4}}$ on each side; all with swollen bases; those of the upper jaw have one large sharp point and three smaller points on the inner side, the longest about one-third the size of the large point; these graduate in size, both the large and small points are denticulate. Each tooth of the under jaw consists of a single, smooth, sharp point on a swollen base. I was unable to detect any denticulations on the lower teeth. (See Plate I, figs. 3 and 4).

The origin of the ventral is located posteriorly to the pectorals by a distance one-third greater than the eye, the fin being midway between the tip of snout and the middle of the base of the second dorsal; height of dorsal 1.50 in head, its base 1.75 in its height; origin of second dorsal midway between tip of caudal and fourth gill opening; height of second

¹ *Bull. U. S. Nat. Mus.* (1896), 47, pt. 1, ix.

dorsal about equal to its base; caudal with two notches, its length one-third greater than head; a distinct pit at base of caudal both above and below; origin of anal midway between origin of ventrals and origin of caudal, being directly below the second dorsal; origin of ventrals midway between under part of caudal and anterior gill opening; length of outer margin of pectorals 1.10 in head, the inner margin 2.60 in outer, the posterior margin concave.

Color in alcohol uniform pale drab above, yellow below; fins uniform with coloring of body, except the second dorsal which has its upper two-thirds black.

This species in appearance resembles *C. dussumieri* (Val.), but the location of the fins and the form of the teeth are different. This is also true of *C. acutus* (Rüppell) which it also resembles.

Type, No. 2720 in the collection of the Bureau of Science, from Sandakan, Borneo. Length, 372 millimeters.

Family DASYATIDÆ. Sting Rays.

Dasyatis kuhli (Müller and Henle).

Color brown above, with large round blue spots; belly yellowish-white. No. 2503; disk 140 millimeters in diameter.

A common sting ray of Borneo, used as food; also found in the Philippines.

Family CLUPEIDÆ. Herrings.

Hisha xanthoptera Bleeker.

Head 4.25, measured to tip of upper jaw; eye 3.75; adipose eyelid well developed; snout 3.35; depth 3.85; scutes strong, 7 on gular region and 27 on belly, a total of 34; dorsal 17; anal 49; villiform teeth on palatines and minute teeth in each jaw; none on vomer. Origin of anal below posterior rays of dorsal.

Color silver bluish from above; a dusky blotch on upper anterior part of opercle, and another posterior to upper portion of opercle; tip of jaws dusky. No. 2713; length, 370 millimeters.

A food-fish of Borneo, not recorded from the Philippines.

Family SYNODONTIDÆ. Lizard-fishes.

Saurida tumbil (Bleeker).

This specimen agrees with Bleeker's² description and figure. It is common in Borneo and used as food. It has not been recorded from the Philippines. No. 2587; length, 195 millimeters.

² Atlas Ichthyologique (1866-1872), 6, 155, pl. 277, fig. 4.

Family MURÆNESOCIDÆ. Eels.

Murænesox cinereus (Forskål).

Color drab-brown above, paler below. The lateral line very distinct; fins yellowish, the tips of dorsal and anal black, these fins becoming entirely dusky near and at end of caudal. Snout long; teeth large, the vomerine teeth with cusps on each side. Nos. 2498, 2500; length 490 to 556 millimeters.

A fish of considerable food importance in Borneo; also recorded from the Philippines.

Family CYPRINIDÆ. Minnows.

Barbus elongatus Seale, sp. nov. Plate II, fig. 1.

Head 4; depth 3.1; dorsal 12; anal 8; scales 5-27 (to end of caudal vertebra)-4; the lateral line curves down to a little below the median line of sides, then up to middle of base of caudal; eye 3.75 in head; snout 4; interorbital 2.70; maxillary scarcely reaching to anterior margin of eye; two maxillary barbules on each side, the longest 2 in head; pectorals about equal to head; ventrals 1.15 in head. No teeth except pharyngeals which are 4-3-2, the larger ones slightly hooked and each with a small shoulder.

Body oblong, compressed, the outline between origin of dorsal and tip of snout somewhat gibbous and with a concave area above the eye; caudal peduncle rather long and slim, its depth being 1.75 in its length; origin of dorsal midway between tip of snout and end of caudal vertebra, the second large ray enlarged and serrated on its upper two-thirds; the enlarged hard portion equal to distance from middle of eye to end of opercles; origin of anal much nearer origin of ventrals than the end of caudal vertebra, longest anal ray 1.70 in head; origin of ventrals midway between origin of anal and posterior margin of opercles; caudal deeply emarginate, its length greater than head. Gill openings restricted, ending on a line with angle of preopercle. Gill rakers small, rather sharp pointed, about 9 on lower arch.

Body entirely covered with large smooth scales which have 4 to 8 striate lines; tubes of lateral line unbranched; ventral with axillary scale; scaly sheaths to dorsal and anal; head entirely naked.

Color silvery with a slight shade of yellowish; four round black spots on middle line of sides, one at base of caudal, one at origin of lateral line, two on the lateral line near the middle. A black spot at origin of anal. Upper rays of dorsal, anal, and caudal, dusky.

This species is nearly related to *Barbus ivis* Seale from Balabac Island, from which it is easily distinguished by its more elongated form, long caudal peduncle, the more anterior location of the anal, and the less distance between the anal and ventrals. This species also has a larger eye.

Type, No. 2566 in the collection of the Bureau of Science, from Sandakan, Borneo. Length 80 millimeters.

Family SILURIDÆ. Catfishes.

Arius sagor Hamilton.

Hexanematichthys sundaicus Bleeker, Atlas Ichth. (1862), 2, 26, pl. 62.

Bleeker³ gives an excellent figure of this species. It is easily recognized by the banded appearance of the upper half of the body. These bands extend down to, or slightly below, the single lateral line and are evident even in specimens which have been long in alcohol. The young do not show the banded markings.

There are four patches of teeth on the palatine, separated by interspaces. The bony shield at base of dorsal spine is separated from the head shield. No. 2497; length, 370 millimeters; Nos. 2437, 2462 and 2518; length, 115 to 135 millimeters, young.

The species is regarded as an excellent food-fish and is common in the market of Sandakan. It has not been reported from the Philippines.

Tachysurus venosus (Cuvier and Valenciennes).

Arius venosus Bleeker, Atlas Ichth. (1862), 2, 33, pl. 54, fig. 1.

Grayish with a silvery wash; the fins have a slightly darker shade; under parts white. Nos. 2514 and 2625; length, 135 to 170 millimeters.

Characterized by an almost smooth head. Two triangular shaped areas of villiform teeth on the palate. A common food fish of Borneo. This species is recorded by Cuvier and Valenciennes from Manila.

Arius argyropleuron (Kuhl and Van Hasselt).

Grayish with a yellowish wash; yellowish white below. No. 2682; length, 145 millimeters.

Characterized by the ovate maxillary patch of granular teeth, the elongate snout, and the dusky, adipose fin. A food fish of Borneo, not reported from the Philippines.

Family PLOTOSIDÆ. Sea Catfishes.

Plotus anguillaris (Bloch.).

Color drab-gray; three longitudinal white stripes on each side from tip of head to tip of tail; fins all washed with slate-gray, darker at extremities; chin, belly, and throat yellowish cream. Nos. 2683, 2446, 2677, 2655; length, 160 to 195 millimeters.

This species is regarded as a good fish, but owing to the stinging wounds inflicted by its spines and because of its small size, it is not often seen in the market. It is also common throughout the Philippines.

³Atl. Ichth. (1862), 2, pl. XIV.

Family BELONIDÆ. Needlefishes.

Tylosurus strongylurus (Kuhl and Van Hasselt).

Head 2.60; eye 3 in postocular portion of head; origin of ventrals midway between origin of pectorals and middle of base of anal. Nos. 2538 and 2696; length, 250 millimeters.

This species is easily distinguished by the round black spot on the base of the rays of caudal.

A food-fish of Borneo; also recorded from the Philippines.

Tylosurus anulatus (Cuv. and Val.).

Head 3; eye 2 in postorbital portion of head; origin of ventrals midway between end of caudal vertebra and anterior margin of eye.

Color silvery, washed with brownish above; pectorals, dorsal, caudal, and anterior part of anal, dusky. Nos. 2667 and 2718; length, 290 to 300 millimeters.

A food-fish of Borneo; also recorded from the Philippines.

Family ENOCCETIDÆ. Half-beaks and Flying-fishes.

Zenarchopterus buffonis Cuv. and Val.

Head 4; depth 6; eye 1.50 in postorbital portion of head; snout 2 in head; interorbital space considerably greater than eye; dorsal 11; anal 12; origin of ventrals midway between tip of caudal and the posterior margin of opercle. Prolonged portion of under jaw beyond the upper 3.75 in head. Length from posterior margin of opercle to tip of under jaw much less than from posterior margin of opercle to end of caudal vertebra. Nos. 2622, 2672, and 2699; length, 170 to 215 millimeters.

A small brackish-water fish, dried and sold for food in considerable numbers in Borneo; also recorded from the Philippines.

Hemirhamphus gaimardi (Cuv. and Val.).

Head 4.25; depth 1.75 in head; exposed under jaw, beyond the upper, 1.75 in head; ventrals located midway between end of caudal vertebra and anterior margin of eye; dorsal 15; anal 15; origin of dorsal very slightly in advance of origin of anal; caudal forked.

Color silvery, bluish above; a blue and a silver line along the side; tip of dorsal and posterior portion of caudal dusky. Nos. 2473, 2640, 2664 and 2666; length, 145 to 195 millimeters.

A food-fish of Borneo; also recorded from the Philippines.

Zenarchopterus dux Seale, sp. nov. Plate II, fig. 2.

Head, from tip of upper jaw, 4 to end of caudal vertebra; lower jaw, beyond the upper, 3 to end of vertebra; posterior margin of opercle midway between tip of lower jaw and end of caudal vertebra; dorsal 12; anal 14, the 6th ray modified into an intromittent organ; scales in lateral series 41, about 45 in lateral line, 6 in vertical series; eye 3.25 in head;

snout 3.1; width of exposed upper jaw equal to its length; origin of anal midway between end of caudal vertebra and origin of ventrals, being below fifth dorsal ray; length of ventrals 2.50 in head; length of pectorals 2.50 in head; caudal truncate, its length equal to distance from posterior end of upper jaw to end of opercle; body covered with smooth deciduous scales.

Color yellowish with a silver stripe along side which is bordered above with dark green. A dusky wash on dorsal and caudal, the anal with a distinct dusky blotch anteriorly.

Type, No. 2679 in the collection of the Bureau of Science, from Sandakan, Borneo. Length, 150 millimeters.

Family ATHERINIDÆ. Silversides.

- *Atherina forskalii* Rupp.

Head 3.50; depth 4; eye 2.30 in head; interorbital about equal to eye; dorsal V-10; anal I, 12; scales 39 in lateral series from enlarged scale above opercle.

Common in Borneo and the Philippines.

Family MUGILIDÆ. Mulletts.

Mugil belanak Bleeker.

One specimen collected agrees with Bleeker's * description and figure.

Color yellowish with a slight brownish wash above; scales with slightly darker centers, giving an indistinctly striped appearance; adipose eyelid moderately developed; tip of maxillary exposed. Origin of spinous dorsal about midway between tip of snout and end of caudal vertebra; origin of ventrals midway between origin of anal and notch of preorbital; origin of anal very slightly in advance of origin of dorsal. No. 2481; length, 175 millimeters.

An important food-fish of Borneo; not reported from the Philippines.

Liza cæruleomaculatus (Lacépède).

Color silvery, slightly bluish above; a black spot at upper axil of pectorals; scales 38. Nos. 2559 and 2602; length, 120 millimeters.

A common and valuable food-fish of Borneo; also recorded from the Philippines.

Family SPHYRÆNIDÆ. Barracudas.

Sphyræna toxéusa Forster.

Head 3.30; depth 6.50; eye 5.50; interorbital 4.75; scales 115.

Dusky above; white below; all the fins more or less stained with gray. No. 2736; length, 440 millimeters.

A valuable food-fish of Borneo; not yet recorded from the Philippines.

* Java, 4, 337.

Family POLYNEMIDÆ. Threadfins.

Polydactylus zophomus Jordan and McGregor.

Five pectoral appendages, the longest not extending beyond middle of pectoral; posterior half of dorsal black; a black spot at origin of lateral line; pectorals shaded with dusky punctulations; tip of ventrals with a slight dusky wash; general color uniform silvery. Nos. 2448, 2624, 2638, and 2687; length, 90 to 100 millimeters.

It is possible that *P. zophomus* Jordan & McGregor is another synonym for *P. plebeius* (Broussonet).

Polynemus tetradactylus Shaw.

Four pectoral appendages, the longest of which extends to middle length of ventrals; tips of fins, except ventrals, shaded with dusky. Head 3.50; depth 3.75. General color silvery with slight brownish wash above. No. 2489; length, 265 millimeters.

A common food-fish of Borneo; also recorded from the Philippines.

Family SYNGNATHIDÆ. Sea-horses.

Hippocampus kuda Bleeker.

A series of four specimens illustrates a considerable degree of variation in this species due to age; the older specimens are much less spinate than the young; a very decided change is seen in the coronet which in the younger form is decidedly five-spined, but with advancing age the front spines gradually atrophy, leaving a three-spined coronet.

The color varies from yellowish-white in young to almost black in adult; usually some five black specks are discernible; all show a more or less banded appearance of the snout. Nos. 2727, 2728, 2729, and 2730; length, 100 to 140 millimeters.

This species is common in Borneo, and also has been taken at numerous points in the Philippines.

Hippocampus barbouri described by Jordan and Richardson⁵ from Cuyo Island is doubtless this species.

Gasterotokeus biaculeatus Bloch.

Nos. 2731, 2732, 2733, 2734 and 2735; length, 205 millimeters.

This species is used to a considerable extent in China as medicine; it is common in Borneo and all over the Philippines.

Family STROMATEIDÆ. Butterfishes or Pomfrets.⁶**Stromateus cinereus** (Bloch.).

Head 3.50; depth 1.50; eye 3.50 in head; snout 1.25 in eye; inter-orbital 2 in head. No ventrals. Anterior rays of dorsal and anal elongate.

⁵ *Bull. U. S. Bu. of Fisheries* (1908), 27, 247.

⁶ In Hongkong fishes of the family *Stromateidæ* are called pomfrets.

Color dull yellowish, some small dusky dots on sides of head and chin. Nos. 2439 and 2894; length 100 to 116 millimeters.

Used for food in Borneo; not yet recorded from the Philippines.

Family SCOMBRID.E. Mackerels.

Rastrelliger brachysomus (Bleeker).

Color dull bluish-gray above, silvery with a yellowish wash below; posterior margin of dorsal dusky, fins otherwise uniform; round dusky spots at base of dorsal. Nos. 2648, 2649 and 2695; length 190 to 200 millimeters.

This species is easily distinguished by its great depth (3 in length), its long gill rakers which project into the mouth making it look "as if full of feathers." Scales below base of pectorals slightly the largest. This species is well described by Jordan and Dickerson.⁷

A common food-fish of Borneo; also found in the Philippines.

Lactarius lactarius (Bloch and Schneider).

Head 2.85; depth equal to head; eye 3.30 in head; dorsal VIII-I, 24; anal III, 26; scales about 60; a row of small teeth in jaws with two or three enlarged canines. Teeth on vomer and palatine.

Color silvery, a very distinct opercular spot. Dorsals grayish at tips. No. 2610; length, 100 millimeters.

Family CARANGID.E. Pampanos.

Caranx speciosus (Forskål).

This species is easily recognized by its yellow color, with the alternating wide and narrow black bands over the body, the anterior one being through the eye; the distinctness of these stripes seems to vary a great deal, but they are never entirely absent. I have seen very old specimens of 400 millimeters in length with the markings very distinct. Nos. 2458, 2465, and 2630; length, 85 to 250 millimeters.

Caranx sexfasciatus (Quoy and Gaimard).

Caranx rhabdotus Jenkins, Bull. U. S. Bu. Fisheries (1903), 23, pl. 1, 193.

Caranx semisomnus Fowler, Journ. Acad. Nat. Sci. Philad. (1904), 12, 2d. ser. 510, pl. 16.

Head 3.10; depth at origin of anal 2.55; eye 3.75 in head; snout 3.50; interorbital space 3.40; dorsal VIII-I, 21; anal II-I, 17; scales about 52 in curved portions of lateral line, and 30 scales in the straight portion; the line becomes straight under the second soft ray of dorsal, the curved por-

⁷ *Proc. U. S. Nat. Mus.* (1908), 34, 603.

tion is 1.45 in the straight, the depth of the curve is equal to the length of snout; breast fully scaled. Adipose eyelid covering the iris posteriorly, very slightly developed anteriorly, cheeks scaled; opercles naked except on upper portion. Maxillar ending on a line with posterior margin of pupil, its length 2.10 in head. A single row of small sharp teeth in each jaw with some slightly enlarged canines anteriorly; the upper jaw in addition has bands of setiform teeth interiorly; teeth on vomer, palatine, and tongue.

Color silvery, with golden reflections. The young have five dusky vertical bands; tips of dorsals and caudal grayish, fins otherwise yellow. A small opercular spot. Inner axil of pectorals dusky. Nos. 2469, 2483, 2567, and 2653; length, 66 to 260 millimeters.

An abundant food-fish of Borneo; also common in the Philippines.

***Caranx brevis* Bleeker.**

Head 4 to end of scutes; depth 3; eye 3.50 in head; snout 3.50; interorbital 3.50; maxillary 2.80, ending on a line with anterior margin of pupil, dorsal VIII-I, 21; anal II-I, 17; 44 scutes in straight portion of lateral line, the line strongly curved, becoming straight under origin of soft dorsal; the curved portion 2.3 in the straight; depth of curve equal to eye; depth of largest scute one-third less than width of eye. Breast scaled; teeth small, in single series in each jaw; villiform teeth on vomer, palatine, and tongue.

Color grayish-blue above, silvery with a yellowish wash below; a very large and distinct opercular spot. Fins yellow, margin of soft dorsal with a wash of grayish; spinous dorsal grayish. Nos. 2460, 2464, and 2646; length, 175 to 260 millimeters.

A common food-fish of Borneo; also recorded from the Philippines. Resembles *C. megalaspis* Bleeker, but the scutes are of much less depth.

***Caranx ira* (Cuv. and Val.).**

Head 3.50; depth 2.55; eye 3.30 in head; snout 3.10; interorbital equals eye; maxillary 2.50, ending on a line with anterior margin of pupil. Breast scaled; lateral line with low curve, becoming straight under 9th dorsal ray; scutes 28, straight portion of line 1.25 in curved; depth of curve less than eye; dorsal VIII-I, 23; anal II-I, 19. Teeth of upper jaw in two series, those of lower jaw in single series, villiform teeth on vomer, palatines, and tongue.

Color silvery with a bluish tint above. Fins all yellowish-white, except soft dorsal, which has the lobe very black, with a white tip, a very characteristic marking for the species. Nos. 2613 and 2738; length, 137 millimeters.

A common food-fish of Borneo; also recorded from Negros, Hoilo, and Manila, Philippine Islands.

Citula armatus (Forskål).

Characterized by the peculiar shape, and the elongate ventral, dorsal, and anal; the ventrals extend beyond caudal; the spinous dorsal is represented by six minute spines; scutes very small.

Color silver, with indistinct dusky bands; a more distinct band extends through the eye. No. 2545; length, 86 millimeters.

A common food-fish of Borneo; also found in the Philippines.

Scomberoides lysan (Forskål).

These specimens are silvery with a bluish wash above; the fins yellowish, the soft dorsal slightly grayish without distinct dusky blotch. The species may be distinguished by the deep body, the short snout, which is less than eye, and the long premaxillary, which is 1.50 in head, ending posteriorly to eye.

Large specimens have the grayish blotches, like finger prints, 6-7 in number, all above the lateral line, except the two anterior ones. Nos. 2459, 2484, and 2506; length, 178 to 300 millimeters.

A food-fish of some importance in Borneo; also recorded from the Philippines. This species affords excellent sport with rod and reel.

Family TRICHIURIDÆ. Cutlass-fishes.

Trichiurus haumela (Forskål).

Head, from tip of upper jaw 6.85; eye 5.35 in head; snout 2.90; interorbital 2.50 in snout.

Color silvery, tip of dorsal dusky. Anterior anal spines not enlarged. No. 2657; length, 331 millimeters.

A common food-fish at Sandakan; also found throughout the Philippines.

Family EQUULIDÆ. Slip-mouths.

Gazza minuta (Bloch).

Head 3; depth 2; eye 2.50, lateral line complete; breast naked; rather strong canine teeth in jaws.

Color silvery, with more or less bronzy reflections; some very indistinct mottling showing on the back in some specimens; axil of pectorals dusky; tip of dorsal with very slight trace of dusky color; fins yellowish-white. Nos. 2569, 2605, 2650, 2658, and 2757; length, 87 to 110 millimeters.

Important as a food-fish because of its abundance. Found also in the Philippines.

Equula ruconia (Hamilton).

Head 3.75; depth 1.50; eye 2.50 in head; lateral line incomplete.

Color yellowish-brown above, with brownish bands and markings; silvery below. Axil of pectoral dusky; some dusky dots on sides of

thorax; a dark line from orbit to chin; tip of dorsal with a slight trace of dusky color. Nos. 2468, 2708, and 2781; length, 45 to 50 millimeters.

Common food-fish of Borneo; also found in the Philippines.

***Leiognathus blochii* Cuv. and Val.**

Head 3; depth 2.1; eye 3 in head; snout 3; interorbital about 3; dorsal VIII, 16; anal III, 14; scales 55 to end of caudal vertebra. A small spine in front of orbit, lower margin of preopercle serrated, mandible moderately curved; length of median crest 2.60 in head, second dorsal spine 2.50 in depth.

Color yellowish-brown above, silvery below; a black band around tip of snout; a dusky blotch on shoulder at end of nuchal spine; numerous vertical or undulating lines over back. Inner axil of pectoral black; some dusky coloring on inside of gill openings. Day⁸ gives a good figure of this species, although in our specimens the dusky saddle on shoulder is not so distinct. Nos. 2556, 2644, 2662, 2711, 2748, and 2756; length, 66 to 100 millimeters.

A common food-fish of Borneo; also recorded from the Philippines.

***Leiognathus caballa* (Cuv. and Val.).**

Head 3; depth 1.55; eye 2.70 in head; dorsal VIII, 16; anal III, 14; second dorsal spine 2.80; breast naked; lateral line complete; superorbital edge serrated; nuchal spine 1.75 in head.

Color grayish-silvery above, with numerous fine vertical lines over back down to near median line of sides; no black on the fins, which are yellowish-white. Nos. 2463, 2515, 2520, and 2551; length, 70 to 110 millimeters.

Leiognathus edentulus Bloch and *L. dussumieri* Cuv. and Val. both have the breast fully scaled and are probably synonymous; they certainly are not the above species which has the breast naked.

***Leiognathus splendens* (Cuvier).**

Head 3.10; depth 1.75; eye 2.50 in head; snout 3 in head; interorbital 2.60; first dorsal spine 2.50 in depth of fish; nuchal crest 1.85 in head; orbital serrated; two distinct spines in front of eye on each side; breast fully and distinctly scaled.

Color silvery, darker above, with some irregular vertical markings scarcely showing, and entirely obsolete in some specimens. A distinct dusky blotch on upper portion of spinous dorsal. Axil of pectoral dusky; end of snout dusky; some dusky markings at tip of anal. Nos. 2543, 2690, 2737; length, 65 to 89 millimeters.

A food-fish of importance because very abundant. Also found throughout the Philippines.

⁸ Fishes of India (1878), 241, pl. 52, fig. 5.

Family APOGONICHTHYIDÆ. Cardinal Fishes.

Amia hyalosoma Bleeker.

Color yellowish, a large black spot on base of anal; black between anterior dorsal spines. Nos. 2608 and 2629; length, 115 millimeters.

Too small to be of much importance as food. Common also in the Philippines.

Amia quadrifasciata (Cuv. and Val.).

Color yellowish, two or three brown stripes on upper half of body, the lower stripe extending to tip of caudal fin; the arrangement of scales on sides gives the appearance of vertical bands. Nos. 2440, 2577, 2594, 2596, 2636, 2676, 2745, 2768, and 2780; length, 57 to 88 millimeters.

Common in Borneo and the Philippines.

Pseudoamia polystigma Bleeker.

Color brownish, specked; a black spot on opercle with a short brown line above it; two brown lines passing downward and backward from the eye. Nos. 2580, 2595, 2663, and 2743; length 65 millimeters.

Common in Borneo; also in the Philippines.

Amia ceramensis Bleeker.

Color yellowish, a black dot on base of caudal; a narrow dusky line along middle of side. Nos. 2456 and 2571; length, 67 to 69 millimeters.

Common in Borneo and the Philippines, but too small to be of importance as a food-fish.

Family AMBASSIDÆ. Climbing Perches.

Ambassis kopsi (Bleeker).

Color in alcohol yellowish-white with an indistinct silvery line down the middle of side. Nos. 2476, 2510, 2544, 2592, 2568, 2753, and 2783; length, 62 to 95 millimeters.

Common in Borneo and in the Philippines; of no importance as food.

Priopis gymnocephalus Lacépède.

Nos. 2707 and 2724; length, 50 to 63 millimeters.

Common in Borneo and also in the Philippines. Too small to be of importance as food.

Family SERRANIDÆ. Sea-basses.

Psammoperca waigiensis (Cuv. and Val.).

Similar to *Lates calcarifer* (Bloch), but without spines on lower border of preopercle.

Color uniform dull brown, centers of scales slightly darker; fins like body, except pectorals and ventrals which are yellowish-white. The

ventrals are slightly stained with gray. No. 2617; length, 166 millimeters.

A valuable food-fish of Borneo; also common in the Philippines.

Lates calcarifer (Bloch).

Silvery-gray; fins gray; pectorals yellow. Strong spines on lower margin of preopercle. No. 2490; length, 290 millimeters.

A valuable food-fish of Borneo; recorded also from the Philippines.

Epinephelus sexfasciatus (Cuv. and Val.).

Color brownish, with dull yellowish and brownish spots; six darker vertical bands down sides; fins grayish without distinct markings. Ventrals darker at tips. No. 2098; length, 121 millimeters.

A valued food-fish of Borneo; also recorded from the Philippines.

Family LUTIANIDÆ. Snappers.

Lutianus erythropterus Bloch.

This species is easily distinguished by the white mark in the posterior axil of the soft dorsal which is followed by a deep black area covering the remainder of the top of caudal peduncle. No. 2900; length, 210 millimeters.

A common food-fish of Borneo; also recorded from the Philippines.

Nemipterus upeneoides (Bleeker).

Head 3.45; depth 3.50.

Color yellowish-white with silvery reflection; darker above; a round dusky spot on the lateral line above middle of pectorals. No. 2516; length, 130 millimeters.

A common food-fish of Borneo; not known from the Philippines.

Lutianus fulviflamma (Forskål).

Color white, with longitudinal yellow stripes; a distinct black blotch on each side. Young specimens have a dusky stripe from eye to tip of snout and on upper portion of preopercles. Fins yellowish. Nos. 2519, 2548, 2486, and 2439; length, 100 to 230 millimeters.

A common and valued food-fish of Borneo; also recorded from the Philippines.

Lutianus vitta (Quoy and Gaimard).

Yellowish-white, with a distinct black line along the side from head to caudal. No dusky shadings on dorsal. No. 2493; length, 210 millimeters.

A food-fish of value in Borneo; also common in the Philippines.

Family HÆMULIDÆ. Grunts.

Spilotichthys pictus (Thunberg).

Our specimens show the complete transformation from the older specimens on which round brownish spots cover the body and extend on the dorsal and caudal, to the young specimens with dark longitudinal bands which are just beginning to break up into rows of round spots. Nos. 2491, 2467, 2604, 2643, and 2740; length, 120 to 210 millimeters.

This species during its various color changes may be distinguished by the presence of only 10 dorsal spines.

A food-fish of importance in Borneo; also recorded from the Philippines.

Euelaticthys crassispinus (Rüppell).

Head 3; depth 2.1; dorsal spines 14.

Color dusky; the fins black without white margins or spots; pectorals grayish-white. The center of each scale is lighter in color giving the appearance of narrow light lines on sides. No. 2489; length, 175 millimeters.

A food-fish of value; also recorded from the Philippines.

Pristipoma hasta Bloch.

Color yellowish with a silvery wash; back and dorsal fins with black spots. No. 2442 represents the form called *P. negeb* Rüppell, probably a color variation. Nos. 2479, 2635, 2442, and 2758; length, 81 to 210 millimeters.

Common in Borneo; also recorded from the Philippines.

Pristopoma therapon Bleeker.

Color silvery; a large oval black spot occupying a large portion of the spinous dorsal, otherwise uniform in color. No. 2589; length, 80 millimeters.

A food-fish of value in Borneo; also recorded from the Philippines.

Family THERAPONIDÆ. Therapons.

Scolopsis vosmaeri Bleeker.

Similar in every respect to the figure given by Bleeker.⁹ Color yellowish white; a white longitudinal stripe backward from origin of lateral line; another white band over nuchal region. No. 2717; length, 156 millimeters.

An important food-fish of Borneo; also found in the Philippines.

⁹ Atlas Ichthy. (1876-1877), 8, 8, pl. 61, fig. 5.

***Therapon quadrilineatus* (Bloch).**

Color silvery, with five longitudinal brown lines on sides; caudal unmarked; a black blotch on spinous dorsal; grayish on anal; tip of soft dorsal dusky. Nos. 2612, 2671, 2725, 2715, 2782, and 2792; length, 77 to 100 millimeters.

A common inshore food-fish of Borneo and the Philippines.

***Therapon jarbua* (Forskål).**

This common species is identical in every respect with the Philippine form. It is characterized by the concave brown lines on sides, the oblique bands on the caudal, and the dusky markings on the dorsal. No. 2615; length, 130 millimeters.

***Therapon puta* (Cuv. and Val.).**

Characterized by the elongate teeth of the preopercle; four straight brown lines on body; oblique brown lines on caudal, the central line of which is straight, being a prolongation of the median brown line of the body; dorsals with dusky markings. Nos. 2524, 2528, 2529, 2530, 2531, and 2749; length, 78 to 100 millimeters.

A common inshore food-fish of Borneo and the Philippines.

Family SPARIDÆ. Porgies.

***Sparus calamara* Russell.**

Color yellowish; centers of scales darker; dorsals, caudal, anal, and ventrals, with dusky tips. No. 2499; length, 200 millimeters.

A food-fish of importance in Borneo; also recorded from the Philippines.

***Lethrinus amboinensis* Bleeker.**

Similar to specimens from the Philippines. Color dull brownish, indistinctly mottled with greenish; a dusky spot between pectoral fin and lateral line. Nos. 2438, 2558, 2582, 2679, and 2742; length, 80 to 120 millimeters.

An excellent food-fish; also found in the Philippines.

Family GERRIDÆ. Mogarras.

***Zystæma punctatum* (Cuv. and Val.).**

Head 3; depth 2.40; eye 2.50 in head.

Color silvery below, with a wash of yellowish; brown above. Some very indistinct darker bands or spots over back. This species is characterized by the elongate second dorsal spine, which in our specimens equals the head. Nos. 2451, 2564, and 2588; length, 75 to 92 millimeters.

A common food-fish of Borneo, also recorded from the Philippines.

Xystæma kapas (Bleeker).

This species has the third anal spine considerably longer than the second; however, the latter is the strongest. Head 3.1; depth 2.35; eye 2.75 in head; snout 4.

Color dull light brown above, silvery below; fins yellowish. No. 2537; length, 87 millimeters.

A common food-fish of Borneo; also found in the Philippines.

Xystæma oyena (Forskål).

Head 3.1; depth 2.1; eye 2.55 in head; snout 3.50; interorbital 2.75; second dorsal spine 2.50 in depth; the third anal spine is the longest, but the second is the strongest.

Color yellowish-white, margin of spinous dorsal dusky, tip of caudal with an indistinct dusky shade. No. 2609; length, 105 millimeters.

A common food-fish of Borneo; also recorded from the Philippines.

Xystæma lucidus (Cuv. and Val.).

Head 3.1; depth 2.30; eye 2.50; snout 4; interorbital 3; second dorsal spine 2.20 in depth; second anal spine longer and stronger than the third.

Color yellowish, slightly darker above with 4 or 5 wide distinct darker bands over back, tip of dorsal black. No. 2583; length, 92 millimeters.

A food-fish of but little importance in Borneo; not recorded from the Philippines.

Xystæma abbreviatus (Bleeker).

Depth about 2 in length; eye 2.50 in head (measured with jaws not projected), pectorals extending well along the base of anal.

Color silvery; centers of scales slightly darker; tip of dorsal dusky. Nos. 2478 and 2542; length, 114 to 185 millimeters.

A food-fish of importance in Borneo; also found in the Philippines.

Family MULLIDÆ. Goat-fishes.

Upeneoides tragula (Richardson).

I have examined several hundred specimens of this species, and they are without exception distinctly speckled with black, with a distinct black line along each side, the anterior dorsal is very largely dusky, the caudal is always distinctly marked with oblique lines; the ventrals and anal are marked with two or three dusky lines. These, aside from structural differences, make the species very easily recognized. Nos. 2435, 2545, 2553, and 2616; length, 110 to 155 millimeters.

A food-fish of Borneo; also recorded from the Philippines.

Upeneoides vittatus (Forskål).

Color dull silvery-brownish; a yellow line on sides; tip of dorsal black, a black line through the middle of fin, another through base of fin; soft

dorsal with three dusky bands; caudal with oblique dusky bands. Belly yellow; anal, ventrals, and pectorals unmarked. Nos. 2551 and 2615; length, 105 to 140 millimeters.

This is a shorter, deeper fish than *U. fragula* (Richardson) and is without black dots.

A food-fish of some importance; also recorded from the Philippines.

Upeneoides sulphureus (Cuv. and Val.).

This species in form and markings somewhat resembles *U. vittatus* (Forskål). However, it has the caudal uniform or with a single dusky line at the margin of the lower lobe; the actual tip of the lower caudal lobe is white; dorsals barred with dusky; ventrals, pectorals and anal yellow, without markings. No. 2633; length, 120 millimeters.

A food-fish of Borneo; also common in the Philippines.

Upeneoides luzonius (Jordan and Seale).

An indistinct dusky saddle over back, just behind soft dorsal; a dusky longitudinal line from eye to caudal; dorsals scarcely marked; caudal with rather fine oblique dusky bars, 7 on lower lobe. Nos. 2447, 2517, 2555, 2572, 2579, 2618, and 2632; length, 90 to 136 millimeters.

This species was originally described from the Philippines.

Family SCLERIDLE. Croakers.

Umbrina russelli Cuv. and Val.

Silvery, a dusky band over shoulders; a dusky blotch on opercles; anterior dorsal dusky; a short barbule; no enlarged canines. No. 2552; length, 103 millimeters.

Common food-fish of Borneo; also recorded from the Philippines.

Otolithus maculatus (Kuhl and Van Hasselt).

Color silvery, the upper portion of body with some scattered spots; our specimens show some indistinct markings on soft dorsal fin. No. 2495; length, 260 millimeters.

A food-fish of Borneo; not recorded from the Philippines.

Pseudosciaena diacanthus (Lacépède).

Color grayish-silvery with numerous brown spots over body and fins; pectorals, ventrals, and anal of a uniform dusky color. No. 2654; length, 165 millimeters.

An important food-fish of Borneo; not recorded from the Philippines.

Johnius borneensis (Bleeker).

Color silvery; tips of dorsals grayish; caudal grayish; an indistinct dusky spot on opercles. No. 2509; length, 205 millimeters.

A food-fish of Borneo; not recorded from the Philippines.

Johnius vogleri Bleeker.

Color dull yellowish with slight silvery reflections; centers of rows of scales darker; a slight wash of grayish on spinous dorsal. No. 2445; length, 190 millimeters.

A food-fish of considerable importance in Borneo; not recorded from the Philippines.

Pseudosciæna anea (Bloch).

Color silvery; fins yellowish-white; jaws almost equal, teeth strong.

Head 2.85; depth 3; eye 4.25 in head; dorsal X-I, 24; anal II, 7; scales about 43; rather strong, curved teeth in each jaw; upper jaw with an inner row of small teeth, none on vomer, palatine, or tongue. No. 2452; length, 105 millimeters; No. 2512; length, 135 millimeters.

A common food-fish of Borneo; also recorded from the Philippines.

Otolithus dolorosus Seale, sp. nov. Plate III.

Head 3.75; depth 5; scales 54 in lateral line, 11 between lateral line and base of anal, 11 between origin of dorsal and lateral line; dorsal XI, 25; anal II, 7; eye 6.20; snout 4.15; interorbital 5; maxillary 2.50; its posterior margin ending under anterior margin of pupil; cheeks and opercles scaled, the opercle with a single flat spine; jaws with small sharp teeth in two or more rows, the outer row slightly enlarged with about 4 enlarged curved canines anteriorly on each jaw; no teeth on vomer, palatine, or tongue; gill rakers rather strong, not very sharp, the longest about equal to diameter of pupil, about 14 on lower arch.

Body oblong, slightly compressed; lower jaw projecting; length of caudal peduncle (measured to a line with posterior axil of anal) greater than depth of body, and almost equal to head; depth of caudal peduncle 3 in its length; longest dorsal ray 1.75 in head; the two dorsals not separated; origin of anal midway between base of caudal and axil of ventrals, under the seventh dorsal ray. First anal spine minute, the second about two-thirds the length of second anal ray; the origin of the ventral considerably nearer the tip of lower jaw than to origin of anal; length of ventrals about 1.40 in head; pectorals 1.30 in head; caudal 1.15 in head; scales of body in oblique rows, those of lateral line enlarged, arborescent.

Color uniform silvery, with more or less distinct narrow black lines following the rows of scales above the lateral line, tip of dorsal and caudal dusky; axil of pectorals dusky.

This species somewhat resembles *O. argenteus* (Kuhl and Van Hasselt), but has much smaller teeth and the location of the fins is decidedly different, the origin of anal being much nearer the base of caudal in *O. argenteus*.

Type, No. 2485 in the collection of the Bureau of Science, from Sandakan, Borneo. Length, 300 millimeters.

Otolithus orientalis Seale, sp. nov. Plate IV.

Head 3.20; depth 4.1; dorsal XI, 28; anal 2.7; scales 51 in lateral line, 7 between origin of anal and lateral line, 6 between origin of dorsal and lateral line; eye 5.45 in head; snout 4.15; maxillary 2.15 ending on a line with posterior margin of pupil; interorbital equal to snout; lower jaw slightly projecting, teeth of upper jaw small, sharp, in two or more rows, those of lower jaw similar but in a single row on each side, two very large curved canines in each jaw anteriorly. No teeth on vomer, palatine, or tongue. Gill rakers short, not very sharp, about 12 on lower arch, the longest scarcely equal to pupil.

Body oblong, slightly compressed, the dorsals not completely divided; longest dorsal spine 2 in head; length of caudal peduncle (measured to angle of anal) about 1.35 in head, being slightly less than depth of fish; its depth 3 in its length. Origin of anal very much nearer to end of caudal vertebra than to axil of pectoral, being under the middle of soft dorsal; second anal spine very short, less than one-third of first ray. Origin of ventrals nearer tip of snout than to anal pore; length of ventrals 1.75 in head; pectorals 1.50 in head; caudal 1.75.

Color uniform silvery with a slight yellowish wash above and with indistinct dusky lines following the rows of scales which run obliquely, the lines extending to below the lateral line; dorsals and caudal tipped with grayish, a grayish spot in axil of pectoral.

Characterized by the posterior position of anal and ventral, the number of scales, and the teeth.

Type, No. 2744 in the collection of the Bureau of Science, from Sandakan, Borneo. Length, 235 millimeters.

Family SILLAGINIDÆ. Kisugos.

Sillago sihama (Forskål).

Head 3.45; depth 5; eye 4 in head.

Color dull yellowish; a silvery stripe along side, which scarcely shows. Tip of dorsal dusky. Nos. 2492, 2755, and 2769; length, 120 to 220 millimeters.

A common food-fish of Borneo; also found in the Philippines.

Family LABRIDÆ. Urasse-fishes.

Chærodon oligacanthus (Bleeker).

Color greenish, a black spot under sixth dorsal spine; just behind and above this is a large whitish area, scarcely showing in some specimens; some indistinct bluish longitudinal streaks on sides, most distinct anteriorly; the young specimens show, in addition, a black spot below and slightly posterior to axil of soft dorsal; the young also may have an additional blackish blotch midway between these black spots (see No. 2455). The ventrals are quite long, reaching to the soft rays of anal.

Nos. 2155, 2180, 2182, 2505, 2525, and 2621; length, 110 to 270 millimeters.

A valued food-fish of Borneo; also recorded from the Philippines.

Family TOXOTIDÆ. Ring-fishes.

Toxotes jaculatrix (Pallas).

Nos. 2475 and 2611; length, 89 to 125 millimeters.

Common in the streams of Borneo; also in the Philippines. Not highly esteemed as food.

Family SCATOPHAGIDÆ. Kitingis.

Scatophagus argus (Gmelin).

Color yellowish-white with a bluish wash. The entire fish, except under parts, covered with numerous round bluish spots. The young are similar but have larger spots. Nos. 2549 and 2722; length, 75 to 130 millimeters.

An important and excellent food-fish in Borneo; also recorded in the Philippines.

Family DREPANIDÆ. Eastern Spade-fishes.

Drepane punctata (Gmelin).

Color silvery, with about ten vertical rows of dots over the back and downward to median line or a little below on sides; a black spot in axil of pectoral; ventral dusky at tip. Nos. 2507 and 2581; length, 100 to 165 millimeters.

A food-fish of value; also recorded from numerous places in the Philippines.

Family EPHIPPIDÆ. Ehippids.

Ehippus orbis (Bloch).

Head 3.15; depth 1.20; three anterior dorsal spines elongate.

Color silvery; very indistinct indications of about four wide dusky bands on back and sides, more distinct in young specimens; pectoral and caudal yellowish; other fins with a grayish tinge. Nos. 2474 and 2626; length, 104 millimeters.

A rare fish in Borneo; not yet recorded from the Philippines, but reported from Formosa.

Family SCORPIDIDÆ. Scorpidis.

Monodactylus argenteus (Linnaeus).

Color silvery; a black orbital band; an additional band at posterior margin of opercles; caudal and pectorals yellow, dorsal and anal grayish, ventrals represented by small spines. No. 2750; length, 60 millimeters.

A valuable food-fish of Borneo; also recorded from numerous places in the Philippines.

Family PLATACTIDÆ. Leaf-fishes.

Platax orbicularis (Forsk.).

Dusky, with black ocular band, another band across posterior portion of opercles; two short bands across caudal peduncle; caudal and pectorals yellowish; other fins grayish, becoming black at tips. Nos. 2477 and 2689; length, 95 to 100 millimeters.

Not of much importance as a food in Borneo; common in the Philippines.

Family CILÆTODONTIDÆ. Butterfly-fishes.

Chætodon ocellatus Bleeker.

Color yellowish with five brown bands; the anterior one darkest and forming the ocular band. The upper portion of the third band has a round black spot at the base of soft dorsal. The fourth is on the margin of dorsal and anal fins. This band has white margins on the caudal peduncle. No. 2575; length, 65 millimeters.

Of no importance as a food-fish; recorded also from one locality in the Philippines.

Family HEPATIDÆ. Tangs.

Hepatus matoides (Cuv. and Val.).

Color dull brownish; a gray ring around base of caudal; dorsal and anal black; ventrals black at tips; pectorals yellowish; caudal grayish at base and on upper and lower margins, darker in center. No. 2721; length, 130 millimeters.

A food-fish of considerable value; also recorded from the Philippines.

Family SIGANIDÆ. Siganids.

Siganus vermiculatus Kuhl and Van Hasselt.

Head 4; depth 2; eye 3.50.

Color dull brown, with numerous vermiculating blue lines. No. 2684; length, 226 millimeters.

A common food-fish of Borneo, not greatly prized; also found in the Philippines, where it is extensively used in the manufacture of *bagonŷ*, a native sauce.

Siganus javus (Linnæus).

Head 3.90; depth 2.10; eye 3.10 in head.

Color dull brown above, with blue dots which become larger and form longitudinal lines on the lower half of body. The blue color really predominates below and gives the appearance of brownish longitudinal lines on a bluish background. Nos. 2454 and 2513; length, 118 to 190 millimeters.

A common food-fish of Borneo; also common in the Philippines.

Siganus albopunctatus (Temminck and Schlegel).

Head 3.1; depth 2.50; eye 3.35 in head.

Color pale brownish above, bluish below; body covered with small blue dots, considerably less than interspaces; yellowish-brown spots on the shoulders. No. 2470; length, 222 millimeters.

A common food-fish of Borneo; also recorded from the Philippines.

Siganus hexagonata Bleeker.

Head 3.75; depth 2; eye 3 in head.

Color bluish, with brownish hexagonal spots larger than the interspaces. The young show scarcely any marking after being in alcohol a short time. No. 2488; length, 235 millimeters; Nos. 2436 and 2685; length, 100 millimeters.

A common food-fish of Borneo; also recorded from the Philippines.

Siganus fuscens (Houttuyn).

Head 3.65; depth 2.45; eye 3.1.

Color dull bluish with some indistinct darker spots. Nos. 2561 and 2754; length, 50 to 90 millimeters.

Common in Borneo; also in the Philippines.

Family TRIACANTHIDÆ. Three-spines.

Triacanthus blochi Bleeker.

Head 3.10; depth 2.80; eye slightly greater than interorbital, 3.10 in head; snout 1.3 in head.

Color silvery, with yellowish blotches on sides. Nos. 2598, 2599, 2619, 2688, and 2793; length, 65 to 110 millimeters.

Common in Borneo; also recorded from the Philippines. Not used as food unless skinned immediately after death.

Family MONOCANTHIDÆ. One-spines.

Monocanthus chinensis (Bloch).

Color dull yellowish-brown, covered with numerous small black spots; caudal barred with dusky. Easily distinguished by the very elongate ventral fin. Nos. 2532, 2661, 2677, 2723, and 2743; length, 70 to 150 millimeters.

Common in Borneo, also in the Philippines, but not used as food as it is reputed poisonous.

Family TETRAODONTIDÆ. Puffers, Poison-fishes.

Tetraodon immaculatus (Bloch and Schneider).

In the series before me the young are colored and marked the same as the adult, all being dull brown above and yellowish-white below; with four or five longitudinal lines down the back. Only one specimen, No.

2784, shows many lines on the belly. Nos. 2502, 2710, 2774, 2777, and 2784; length, 44 to 184 millimeters.

Common in Borneo; also in the Philippines. Regarded everywhere as poisonous.

Tetraodon fluviatilis (Hamilton).

Characterized by the large round black spots which cover the body; belly yellowish-white; caudal distinctly barred with black. Nos. 2527, 2600, 2601, 2628, 2680, 2681, and 2771; length, 45 to 110 millimeters.

Common in Borneo; also recorded from the Philippines. Regarded as poisonous.

Spheroides lunaris (Bloch).

Depth about 3; eye 3.10. Color silvery; a slight dusky wash on back. Nos. 2560, 2656, 2677, and 2691; length, 90 to 150 millimeters.

Common in Borneo; also in the Philippines. Poisonous.

Family GOBIIDÆ. Gobies.

Rhinogobius caninus (Cuv. and Val.).

The most distinctive color marking of this fish is the blue-black spot just above, and on a line with, the posterior margin of opercles. There are also about five dusky blotches along sides, alternating with the dusky bands over back; fins more or less grayish; ventrals darker. The males usually have the anterior dorsal spines elongate. Nos. 2443, 2457, 2522, 2550, 2591, 2620, 2623, 2631, 2642, 2674, 2718, 2746, and 2778; length, 75 to 120 millimeters.

Common in Borneo, also in the Philippines. It is of no importance commercially.

Oxyurichthus cristatus (Day).

Our specimen corresponds perfectly with the description and figure given by Day.¹⁰ No. 2765; length, 95 millimeters.

Common in Borneo and the Philippines.

Rhinogobius nebulosus (Forskål).

The mottlings on this specimen are not so distinct as on our Philippine specimens, but this is probably due to methods of preservation. No. 2767; length, 75 millimeters.

Gnatholipis callurus Jordan and Seale.

Our specimens from Borneo are identical with the cotype of this species from the Philippines, except number 2593, which seems to have a slightly sharper profile and may be a different species. Nos. 2453, 2586, 2593, 2694, and 2787; length, 50 millimeters.

¹⁰ Fishes of India (1878), 291, pl. 62, fig. 8.

Glossogobius aglestes Jordan and Seale.

These specimens have the large mouth and the color markings of the Philippine cotypes of this species, although an examination of a good series may show specific differences. Our specimens are in poor condition. Nos. 2701, 2707, and 2712; length, 85 millimeters.

Family SCORPÆNIDÆ. Scorpion-fishes.

Gennadius stoliczæ (Day).

Color pale yellowish, mottled with brownish; fins barred with brown; no cranial spines. No. 2606; length, 110 millimeters.

Not common; recorded from the Philippines.

Prosopodasys trachinordes (Cuv. and Val.).

Dorsal III, 12, 4, anal III, 3.

Color yellowish, mottled with brownish specks; fins barred with dark brown. Nos. 2472, 2533, 2693, 2702, 2709, 2762, 2763, 2775, and 2791; length, 48 to 62 millimeters.

Not recorded from the Philippines, and differing chiefly from Philippine species of this genus in the number of spines.

Polycaulus elongatus (Cuv. and Val.).

These specimens agree with Day's description and figure,¹¹ which he states are identical with Bloch and Schneiders type examined by him. Nos. 2534, 2741, and 2779; length, 60 to 85 millimeters.

Not reported from the Philippines.

Family PLATYCEPHALIDÆ. Flatheads.

Thysanophrys tentaculatus (Rüppell).

Color clove-brown, without distinct bands over back, all the fins more or less mottled with brownish; anal and ventrals tipped with brownish; however, the ventrals are fully colored above. Tentacles of eye very distinct, the spines at angle of opercles very short, about equal to width of nostril. Head with few low spines. No. 2496; length, 315 millimeters.

This species is common at Sandakan; it has also been recorded from Cuyo, Philippine Islands. It is esteemed as a food-fish.

Platycephalus indicus (Linnæus).

Pale sepia above, yellowish-white below; rays of the dorsals barred with brown; a dark median line on middle of caudal fin with converging dark lines from the upper and lower portions of the fin, meeting the median line at its extremity; four or five brown dots on the upper ray of caudal.

¹¹ Fishes of India (1878), 164, pl. 39, fig. 6.

The entire body has a more or less finely reticulated appearance. No. 2501; length, 160 millimeters.

A food-fish of small value. This species has been reported from numerous places in the Philippines.

Thysanophrys bobossok (Bleeker).

Brownish, with darker bands over back; sides of head with four dark vertical stripes about as wide as interspaces; caudal banded with brownish and white; spinous dorsal with a large dusky blotch; second dorsal rays banded with brown; anal yellowish-white, some dusky spots on margin; pectorals and ventrals with brownish markings. Lateral line with small spines anteriorly; preopercular spine \uparrow in head. Nos. 2504, 2553, 2652, 2678, 2704, 2714, and 2772; length, 77 to 155 millimeters.

A very common species but not large enough to be of importance for food. It has not yet been recorded from the Philippines.

Thysanophrys scaber (Linnæus).

Grayish-brown, with some very indistinct dusky bands over back; ventrals and anals with dusky tips; spinous dorsal and caudal each with a dusky blotch; soft dorsal and pectorals barred with brown. Characterized by the lateral line having spines extending its entire length. Nos. 2449, 2641, and 2665; length, 150 to 180 millimeters.

A common species in Borneo, but not yet reported from the Philippines.

Our specimens differed from the figure given by Bleeker¹² in having the lower and posterior half of caudal taken up by a large dull dusky blotch, the brown bars showing only on the upper portion of the fin. It may be different.

Family PLEURONECTIDÆ. Flounders.

Microbuglossus humilis (Cantor).

Color dull brown, with numerous fine dusky spots; a row of larger round black spots near bases of fins. Nos. 2563, 2570, 2576, 2697, 2764, and 2766; length, 60 to 70 millimeters.

Not recorded from the Philippines.

Pseudorhombus javanicus Hamilton.

Color dull brown, with slightly darker blotches and spots; two dark spots on lateral line, one of which has scarcely a trace of an angle above the nostrils, the other has it quite distinct. Nos. 2466 and 2471; length, 155 to 175 millimeters.

It is probable that Jordan and Richardson¹³ were wrong in regarding *P. polyspilus* collected by Doctor Lung in Cavite as belonging to this species.

¹¹ Atlas Ichthy. (?) 9, pl. 419, fig. 5.

¹² Bull. U. S. Bur. Fisheries (1907), 37, 281.

Cynoglossus borneensis (Bleeker).

Head 4; depth 4.

General color dull yellowish-white; the fins darker posteriorly. No. 2659; length, 130 millimeters.

Common in Borneo; not recorded from the Philippines.

Cynoglossus kapwasensis Fowler.

Nos. 2461 and 2670; length, 95 millimeters. These specimens seem to correspond with the description and figure given by Fowler.¹⁴ His specimens came from Western Borneo.

Cynoglossus macrolepidotus Bleeker.

I refer this to the above species with considerable doubt, as our specimens seem to be of less depth, 5.50 in total length to tip of caudal. The head is 5.1, two lateral lines on left side, scales large. No. 2510; length, 210 millimeters.

A food-fish of Borneo of considerable importance; also recorded from the Philippines.

¹⁴ *Proc. Phil. Acad. Sci.* (1905), July, 519.

LIST OF ILLUSTRATIONS.

PLATE I.

- FIG. 1. *Charcharias borneensis* Seale, sp. nov.
2. Ventral surface of head.
3. Upper tooth.
4. Lower tooth.

PLATE II.

- FIG. 1. *Barbus elongatus* Seale, sp. nov.
2. *Zenarchopterus dur* Seale, sp. nov.

PLATE III.

Otolithus dolorosus Seale, sp. nov.

PLATE IV.

Otolithus orientalis Seale, sp. nov.



FIG. 2.

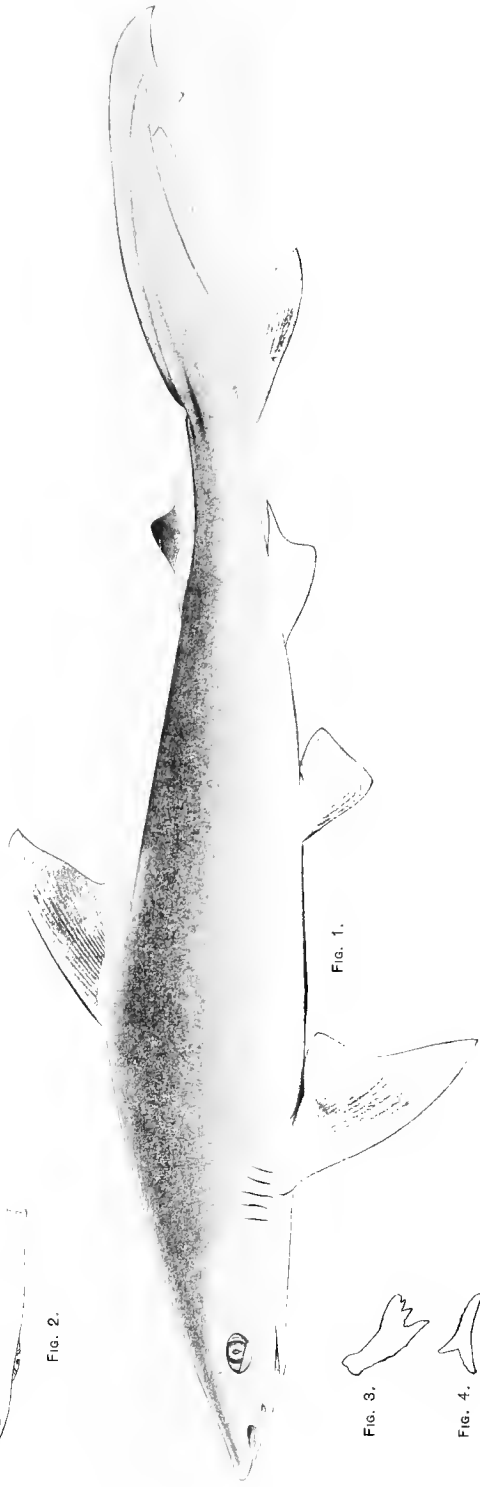

FIG. 1.



FIG. 3.



FIG. 4.

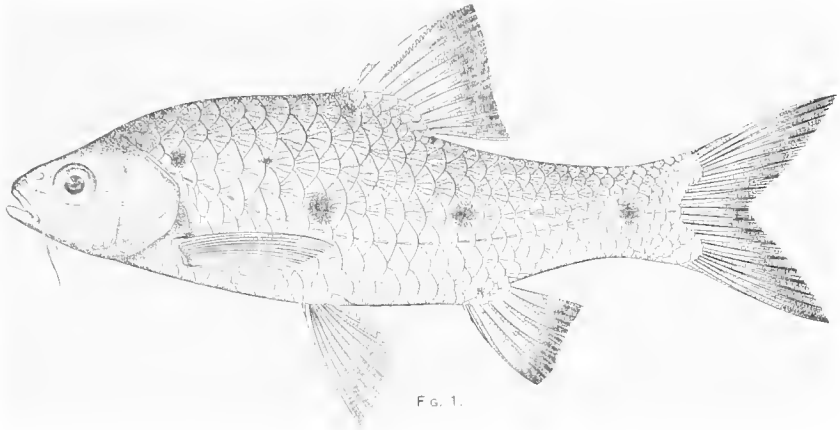

FIG. 1.

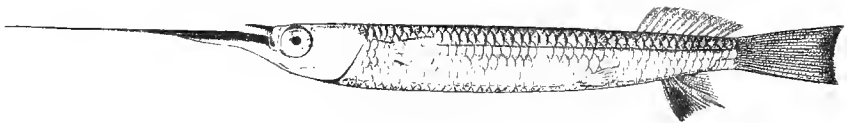

FIG. 2.

PLATE II.

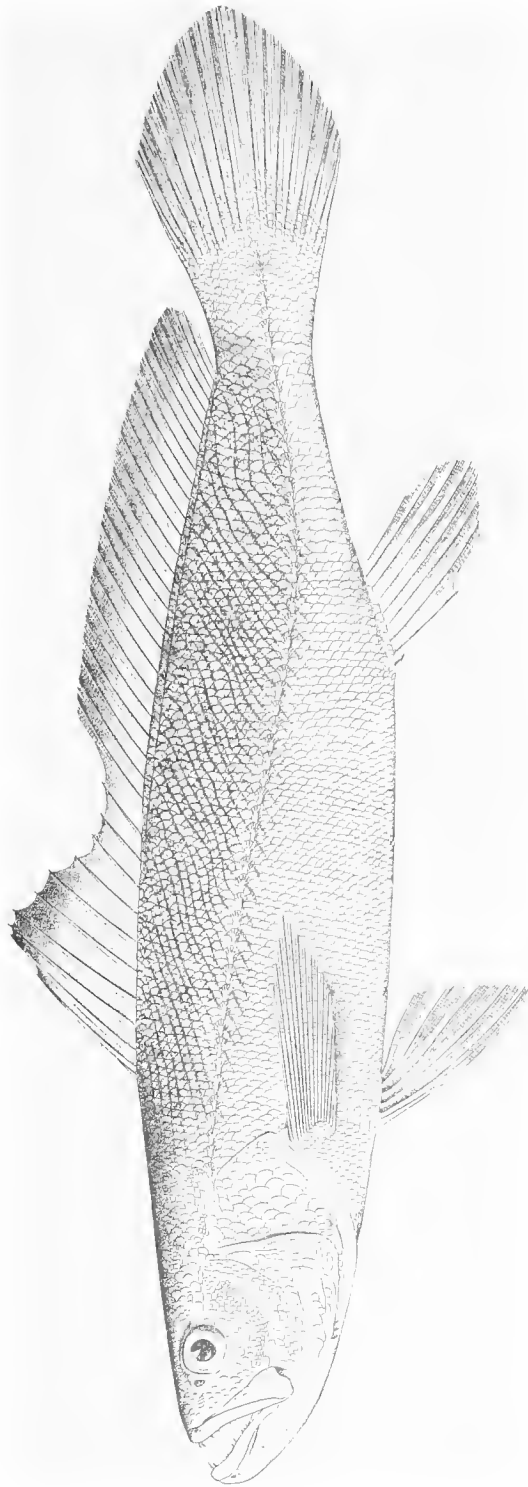

PLATE III.

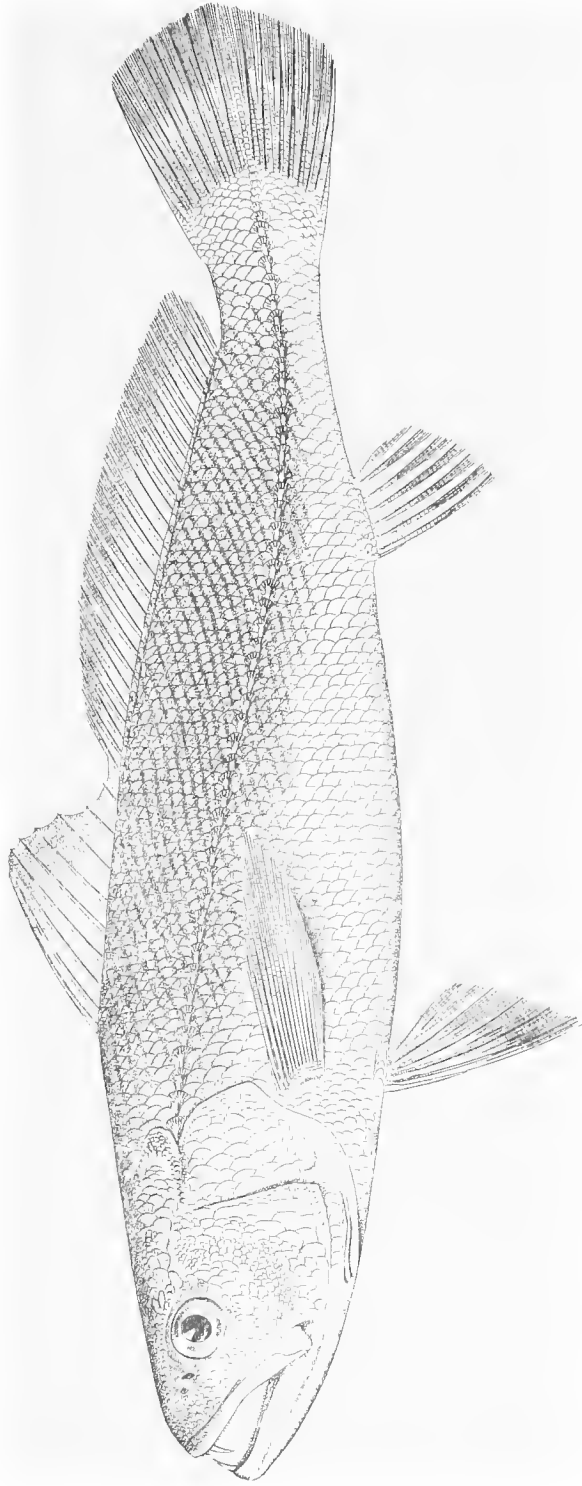

PLATE IV.

THE PHILIPPINE
JOURNAL OF SCIENCE

A. GENERAL SCIENCE

VOL. IV

NOVEMBER, 1909

No. 6

NEW SPECIES OF PHILIPPINE FISHES.

By ALVIN SEALE.

(From the Section of Fisheries, Biological Laboratory, Bureau of Science,
Manila, P. I.)

The present paper is based on the study of about ten thousand specimens of fishes collected in the Philippine Islands by the author and his native assistants, C. Canonizado and Datto Ali, during 1907 and 1908. The collections were made in almost all the important islands of the Archipelago. All of the specimens were taken to Stanford University and compared with the material in the collection of that institution which included a number of types. All types mentioned in this paper are in the ichthyological collection, Bureau of Science, Manila, P. I.

I take this opportunity to thank President David Starr Jordan for valuable suggestions in regard to the work.

Family MURENIDÆ. The Morays.

*Gymnothorax indong*¹ Seale, sp. nov. [Indong-indong.]

² Head 3.50 in body to anal pore; tail is longer than the body by a distance equal to about two-thirds of head; eye 2 in snout; snout 5 in head; interorbital space equal to eye. Mouth large, the jaws not closing completely, mandible 1.70 in head; gape 2. Teeth strong and saber-like,

¹ Indong is a Moro name for Morays.

² All comparative measurements in this paper are taken in the length from tip of snout to end of last caudal vertebra, and the head is measured to posterior edge of hard operculum and excluding the membranous opercular flap. Scale count is to end of caudal vertebra, the vertical series being counted at origin of anal, unless otherwise stated.

in a single series in each jaw. Three large median canines anteriorly, no teeth on shafts of vomer except a few small ones at its extreme posterior end. Posterior nostrils consisting of a large round pore situated just above the anterior half of iris, anterior nostrils consisting of two tubes at extremity of snout, their length about two-thirds of eye. Between the nostrils, the skin on sides of snout has a loose fold capable of dilatation. Dorsal fin is low, beginning slightly anterior to gill opening, which is of moderate size, being about equal to eye. Origin of anal fin at anal pore, fins are low, the dorsal the highest, its longest rays being almost equal to snout. The fins are continuous around caudal.

Color in life, brown with irregular-shaped black blotches, which assume the form of irregular, broken vertical bands slightly less than interspaces. Head has a distinct elongate white mark between eye and gape of mouth, this white stripe penetrates the lower portion of a large blackish blotch bordering the posterior portion of eye; another short white stripe from anterior border of eye to middle of maxillary. A black blotch in angle of jaws which is bordered anteriorly by an elongate white stripe on the mandible. A dusky area crossing near the posterior portion of lower jaws, this area with a white median line. Throat crossed with narrow white lines, pores of jaws white, the fins are barred with black.

Color in alcohol similar but slightly faded.

Type is No. 4445, a specimen from Zamboanga, Mindanao, P. I., 16 June, 1908. Length, 385 millimeters.

Gymnothorax samalensis Seale, sp. nov.

Head 3.80 in body; body is shorter than tail by a distance equal to under jaw; gape of mouth 2.70 in head; snout 6.75 in head; eye 1.25 in snout; interorbital space, measured to include soft portion, is equal to eye; posterior nostrils round, pore-like; openings of nostril just above eye; anterior nostrils consisting of two rather long tubes at end of snout, their length about two-thirds of eye. Teeth of upper jaw in a single series except in front where there are several enlarged canines, four enlarged depressible ones in the median line; vomerine series single, about 10 in number, short and rounded. Teeth on lower jaw in a single series except in front, where there are about five or six enlarged depressible canines on each side. Origin of dorsal, a distance equal to length of snout in front of gill openings. Origin of anal directly back of anal pore, the fins of moderate length.

Color in alcohol brownish with indistinct darker cross-bands, more numerous and distinct on posterior of tail, almost obliterated anteriorly; belly and throat yellowish. A distinct white blotch on lower jaw just in front of angle. A white spot on upper jaw below eye and another halfway between eye and tip of snout; these form rings around the mucous pores. Three similar white spots on lower jaw. Top of head and snout

brown, the color fusing gradually with the yellowish of the under jaw and throat.

Type is No. 3781 from Samal Island, Gulf of Davao, Mindanao, P. I., 1 May, 1908. Length, 220 millimeters.

Family OPHICHTHYIDÆ.

Jenkinsella oliveri Seale, sp. nov.

Head 5.10 in body; body 1.80 in tail; gape 1.75 in head; snout 5.75 in head; eye 1.75 in snout; interorbital space about equal to eye; upper jaw projecting beyond lower by a distance equal to eye; upper lip well fringed; mouth large; mandible 2.50 in head. Teeth in lower jaw in two rows, short sharp teeth, no canines. Teeth of upper jaw in two rows on sides, the inner row being larger and depressible; vomerine teeth in two series, uniting posteriorly into one; a patch of 8 or 10 sharp teeth at tip of upper jaw; no canines; posterior nostrils with an inflated membranous opening more or less fringed. Their location midway between eye and anterior nostril; the anterior nostril is tube-shaped, near end of snout, length about two-thirds length of eye. Several distinct pores on head, one just above and in front of eye, another on middle posterior portion of interorbital space. Origin of dorsal fin about the length of pectorals in front of the gill openings and extending to tip of caudal, its longest rays slightly more than half depth of body, pectorals 3.30 in head. Origin of anal directly behind anal pore, it extends to tip of caudal, no caudal fin.

Color, light yellowish brown above, yellow below median line, belly whitish, sides finely punctulate with minute black specks, throat white, top of head brown, these two colors uniting in a sharp line on the middle of side of head, extending from angle of fins to gill openings; tip of snout and anterior portion of dorsal darker.

Type is No. 4299 from Zamboanga, Mindanao, P. I., 2 June, 1908: Length, 360 millimeters.

Moringua cagayana Seale, sp. nov.

Head 8.75 in body to anal opening, the caudal being just one-third of total length from tip of snout to tip of caudal; angle of mouth 4.50 in head; snout 8; eye 2.25 in snout; interorbital 1.10 in snout; pectorals equal to distance from tip of snout to posterior of eye. Origin of dorsal fin posterior to vent by a distance equal to the length from tip of snout to tip of pectorals, its origin being over the anterior third of anal, the fin is then high and distinct for about this same distance when it becomes atrophied, reappearing again near tip of tail to form part of the paddle-shaped end of caudal. The anal fin is similar to dorsal but its origin is nearer the anal pore. Both the anal and dorsal widen at the end of tail and unite with caudal forming a wide paddle or fin-like end to the

fish, the caudal is lunate, its length equal to upper jaw. A single row of rather short strong canine teeth in each jaw and irregular double row of the same kind down shaft of the vomer. Posterior nostril consisting of a large round open pore with a membrane on its anterior margin. Anterior nostril consisting of a small round pore with a membranous cover formed something like lips to the small central opening, each nostril on a line in front of eye. Buccal cavity large and baggy.

Color yellow brown, the posterior of tail and the head brown, a black line along the entire dorsal surface, angle of jaws white, fins brown except pectorals which are yellowish.

Type is No. 1621 caught in the sea near Cagayan, Mindanao, 13 September, 1907.

Probably the form most nearly related to this species is *M. bicolor*.

Family CYPRINIDÆ. The Minnows.

Barbus ivis Seale, sp. nov. Plate I. [Ivis.]

Head without opercular flap 3.75; depth 2.55; dorsal 10; anal II, 6 (not counting branch on last ray) scales 4-23-3, the lateral line curves down to a little below median line of sides, then up again to middle of caudal peduncle; eye 4.70 in head; snout 3.50; interorbital space 2.35; maxillary 3.10 in head, its end under anterior margin of eye. Two maxillary barbules on each side, the lower one the longest, its tip reaching to angle of preopercle; mandible 2.55; pectorals 1.15; ventrals 1.45.

Body is oblong compressed, the upper outline between the spinous dorsal and head is distinctly gibbous; the lower outline from anal to tip of snout is a low even curve, the profile of head from nape to tip of snout is practically straight. The greatest depth of the body is at origin of ventrals. Length of caudal peduncle 1.50 in head, its least depth 1.75; its median width 6.50. The upper portion of head is somewhat rounded, the interorbital space is very slightly convex. Snout is rounded at tip, its median width is slightly greater than its length; anterior nostril with a funnel-like membrane. Greatest depth of head 1.35 in its length, the greatest width 1.55. Eyes small, less than snout. Mouth small, the upper lip closing over the lower. No teeth except pharyngeals, which are 5-3-2, larger ones slightly hooked with a small shoulder. Gill openings restricted, ending on a line with angle of preopercle.

Gill rakers rather short, shaped something like the pharyngeal teeth with the points exaggerated, 7 on lower limb, the longest 3 in pupil.

Body entirely covered with large smooth scales which have five or six striate lines in the centers. Dorsal and anal with high scaly sheaths, base of caudal scaled, ventrals with a long axillary scale, pectorals without axillary scale. Head entirely naked.

Origin of spinous dorsal midway between end of last caudal vertebra and nostril, the third ray of which is large and modified, the longest being 1.14 in head, its hard portion is distinctly serrated except on its lower third; posterior ray 1.50 in modified ray; base of anal 1.55 in head. Origin of anal is slightly nearer origin of ventrals than to end of caudal vertebra; its longest ray 1.55 in head, its base 2.75, its last ray 3; ventral fins are midway between anal and origin of pectorals, their tip not reaching to anal pore; pectorals low on body. Caudal deeply emarginate, its length a fifth greater than head.

Color in life is grayish above, the margins of the scales darker, shaded with greenish, yellowish on sides, shading into pinkish below. From 3 to 5 black spots along the median area of sides, all specimens have at least an indication of a dusky stripe connecting these spots, some show the stripe very distinctly; a slight dusky blotch just below origin of dorsal, none at origin of anal. The head has some bronzy markings on opercles and in front of eye. Dorsal grayish with dusky tip, caudal pinkish with dusky tip, the lower lobe bright red, anal and ventrals bright red with slightly dusky tips. Pectorals bright red.

Color in alcohol is similar except the dark markings show more distinctly. The lower half of fish is yellowish white, the fins are yellowish, dorsal, caudal, and anal with dusky tips.

Ninety specimens from a small stream near the town of Balabac, Balabac Island. Type is No. 5233, Balabac Island, P. I., taken by the author 11 August, 1908. Length, 130 millimeters.

Family BELONIDÆ. The Gars.

Oxyporhamphus brevis Seale, sp. nov. Plate II. (Bamban).

Head 4.40; depth 8.50; dorsal 15; anal 15; scales are very deciduous, about 50 from axil of pectoral to end of caudal vertebra; eye 3.75 in head; snout 3.20, the width of the free triangular portion of upper jaw considerably greater than its length; maxillary equal to eye; mandible 1.75 in head, the beak on under jaw scarcely developed, its length beyond the end of upper jaw equal to pupil of eye; interorbital space equal to eye; pectorals 1.75 in head; ventrals 2.45.

Body elongate, compressed, length of caudal peduncle 3 in head, its least depth 1.50 in its length, its width 3.

Upper profile of head and snout a low even curve; interorbital space like nuchal region very slightly convex, a wide distinct ridge down the middle of interorbital space; greatest width of head 2.50 in its length, its greatest depth 2.10. The most characteristic thing about the head is the extremely short beak of under jaw which while it varies slightly, in most specimens and in type is nearly equal to width of pupil of eye or 2.50 in snout. Eyes of moderate size, impinging slightly on upper profile; mouth large, teeth in villiform bands in jaws, none on vomer,

palatine, or tongue. Gill openings carried forward to below anterior margin of eye. Gill rakers short, wide at base, sharp, pointed, and denticulate on their inner surface, about 20 on lower limb, the longest less than pupil.

Entire body covered with large, smooth, thin deciduous scales; head naked; vertical fins scaled. Origin of dorsal is just one-third distance between end of caudal vertebra and lower axil of pectorals, its longest ray 1.90 in head. Origin of anal is under third ray of dorsal, its longest ray 3.50 in head. Origin of anal is slightly nearer the origin of ventrals than to end of last caudal vertebra. Origin of the ventrals is midway between end of last caudal vertebra and angle of preopercle. Caudal forked, upper lobe scarcely equal to head, lower lobe considerably longer.

Color in life greenish above, silvery and white below, a distinct silvery band on side, bordered above by a narrow greenish band, fins white, the dorsal, anal, and caudal distinctly tipped with jet black.

Color in alcohol dull yellowish, green above, margins of scales darker. Sides with silvery bands which have a bluish green upper margin, yellowish white below. Cheeks silvery; tip of under jaw, snout and top of head more or less dusky; eyes golden, with dusky blotch above; dorsal, caudal, and anal yellowish, broadly tipped with jet black; pectorals and ventrals yellowish, a black spot on upper base and axil of pectorals.

Fourteen specimens, type is No. 5301 from Paawacan, Palawan Island, P. I., 14 August, 1908. Length, 145 millimeters.

Family ATHERINIDÆ. Silversides.

Atherina regina Seale, sp. nov. Plate III, fig. 1. (Gunoc.)

Head 3.50; depth 4.95; dorsal VI-I, 10; anal I, 10; scales 36, counting from the enlarged scale directly above axil of pectoral, 7 in vertical series; eye 2.25 in head; snout 4; interorbital space 2.75, being less than eye; maxillary 2.50; mandible 2; pectoral 1.25; ventrals 1.60; depth of caudal peduncle 3.45.

Body elongate, moderately compressed, greatest depth at origin of ventral fins. Caudal peduncle compressed, its least depth equal to twice its length.

Head heavy and rather blunt, its greatest width equal to its greatest depth, the lower portion of head strongly compressed. Interorbital space is slightly concave, caused by the prominence of the superocular ridges, these bones form distinct ridges on upper lateral part of snout. Top of snout flat except the small hump anteriorly caused by the processes of the maxillary, the anterior margin of the snout is an even concave curve, with a point on each side of processes; width of snout considerably greater than its length. Eye large; mouth large, oblique, the lower jaw slightly protruding. Maxillary narrow, ending on a line with the front margin of iris. Mandible ending under anterior third of pupil.

Preorbital with two or more distinct pores. Teeth in villiform bands in jaws, a small patch of villiform teeth on vomer, back of tongue, and pterygoids; the type specimen has the vomer broken but the two cotypes show teeth on the vomer; no teeth on palatine. Gill openings wide. Gill rakers long and slender, twenty-five or more on lower arch. Pseudo-branchia large.

Scales large and smooth, their margins rounded and scarcely broken, the scaling not extending on the head except on the occiput, no scales on the fins except on base of caudal, but there is a distinct sheath of scales for the soft dorsal and anal. Top and sides of head well furnished with pores. A very large one just above opercles. There are sixteen scales in front of dorsal fin, ten scales between the origin of the two dorsals, and six scales along the base of the soft dorsal.

The origin of the spinous dorsal is midway between end of caudal vertebra and the anterior margin of eye, its longest spine is equal to orbit, the spines are slender and pungent. Soft dorsal on a line with origin of anal, and much nearer tip of ventrals, or to spinous dorsal, than to caudal; the second ray is longest being 1.85 in head; anal rays similar to soft dorsal, the longest being 2 in head. Origin of ventrals midway between end of maxillary and origin of anal. The anal pore is located between the posterior third of the ventral fins. Caudal rather large and deeply emarginate, the lower lobe being at least 1.40 in head. Pectorals are above the median line of body.

Color in alcohol is straw-yellow all the scales on upper half of body more or less punctulate with fine black or bluish dots. These black dots very thick on the middle of the three rows of scales on the back forming a median dark line on its either side. A distinct silvery band occupies the entire median row of scales on the side, the upper margin of this band is of a dull lead color, a double row of small black dots separating the two colors; there is an additional row of very minute black dots on the row of scales below the silvery stripe. The lower third of body is unmarked. Snout and rim of lower jaw washed with dusky, a distinct dusky spot at upper anterior margin of opercle directly behind eye, a dusky spot at upper axil of pectorals and a dusky bar across its inner base; a dusky area just over and impinging on eye. Dorsal, anal, and ventral fins uniform yellowish white. Pectoral with a distinct dusky blotch occupying an area slightly greater than eye at the beginning of the posterior third of fin; the tip of pectorals and the basal third of most of the rays white. Caudal slightly washed with dusky, two more or less distinct dusky blotches on its base.

The type is No. 2082, in the collection of the section of fisheries, Bureau of Science, Manila. It was secured by the writer at Culion Island, P. I., 7 October, 1907. Length of type, 80 millimeters. Two additional specimens No. 2083 were secured the following day at the neighboring island of Busuanga.

This species is related to *A. pinguis* Lacépède, which is no doubt the *A. lacunosa* Forster from which it differs in the fewer scales, location of fins, size of eye and absence of teeth on the palatines.

It somewhat resembles *A. morrisoni* Jordan & Starks but their fish has 14 anal rays and scales 45 and the origin of the anal is in advance of the soft dorsal.

A. tsuruga Jordan & Snyder is a long panetela-shaped fish whose chief resemblance to the present species consists in its dusky spot on the pectorals; in other respects it is quite different. *A. lacunosa* Bleeker has no black spot on pectorals. *A. insula* Jordan & Seale has a large number of scales and is a quite differently shaped fish. I have compared this type with all of the above species now in the Stanford University museum and find it quite distinct.

Atherina balabacensis Seale, sp. nov. Plate III. fig. 2. (Gunoc.)

Head 3.75; depth 4.10; dorsal VI-I, 10; anal I, 12; scales 36; six in vertical series; eye 2.10 in head; snout 5; interorbital space 2.50, being less than eye; maxillary 2.50; mandible 2; pectorals 1.10; ventrals 1.80; depth of caudal peduncle 3.

Body elongate, moderately compressed, rather heavy and deep, its greatest depth at origin of spinous dorsal; the back is slightly but evenly curved; caudal peduncle compressed, its least depth 1.50 in its length, measured from end of caudal vertebra to posterior axil of anal.

Head rather heavy and deep, its depth being considerably greater than its greatest width, the lower profile of head is an even rounded curve while the upper profile from the occiput is almost straight. The lower jaw is the longest, forming the anterior point of head. The interorbital space is almost flat and has three short low ridges. Width of snout equal to its depth at its median point. Top of snout flat except for the small hump caused by the processes of the maxillary. Mouth large, oblique, the lower jaw protruding. Maxillary narrow, ending on a line with anterior margin of orbit. Mandible ending under the anterior margin of pupil. Preorbital with about four large pores or mucous cavities which give this bone a sculptured appearance. Villiform teeth in jaws, vomer, pterygoids, and back of tongue; no teeth on palatine. Gill openings large and carried forward to below anterior margin of iris. Gill rakers long, slender, and numerous. Pseudobranchia large, longer than the longest gill filaments. Isthmus long and narrow, a distinct groove on its lower surface.

Scales large and smooth, their margins not rough nor denticulate. Head without scales, fins unscaled, but with a scaly sheath to the soft dorsal and anal. Head is well furnished with numerous pores and canals. Fifteen scales in front of dorsal fin; nine scales between the margin of the two dorsals, and six scales along the base of the soft dorsal.

The origin of the spinous dorsal is midway between end of caudal

vertebra and the posterior margin of pupil, its longest spine is equal to orbit, the spines are slender and pungent. Origin of soft dorsal on a line with the origin of the fourth ray of anal, and much nearer spinous dorsal and tip of ventrals than to base of caudal, the second ray is longest being 1.80 in head. Anal similar to soft dorsal, its longest ray 1.50 in head. Origin of ventrals midway between origin of anal and a line with anterior margin of pupil. Anal pore between and at beginning of posterior half of ventrals. Caudal deeply emarginate, its lower lobe at least 1.20 in head. Pectorals are above the median line of body.

Color in alcohol straw-yellow, a slight greenish wash above. The scales above lateral line with fine dark punctulations. A dusky line along the middle of back from head to caudal, some darker shadings at the origin of the two dorsal fins, a dusky line from origin of anal fin to caudal. A bright silvery stripe occupies the middle third of the median line of scales, a narrow lead-colored margin along the upper margin of this silvery stripe, the row of scales below this silvery stripe has a row of very small black dots along its middle, there is also an indistinct incomplete row of dots on the next row of scales below. Base of pectorals with a dusky band and dusky spot in axil. A dusky blotch on upper part of eye. Lower jaw, top of head, and snout, shaded with dusky. No dusky spot on pectoral rays. Fins all grayish white, the caudal with a slight dusky wash, but without dusky spots at base.

The type is No. 4983 from Balabac Island, P. I. Taken by the writer 1 August, 1908, near the mouth of a small stream. Length of type, 10 millimeters. Eight cotypes were secured from the same locality, Nos. 4983, 5308 and 5229. Additional specimens of this species were secured from the following places: 1241 Samar Island, 1295 Cebu, Cebu Island, 1370 Siquijor Island, 1447, 1457, 1495, 1658 and 1659 Cagayan, Mindanao Island, 1981 and 5475 Puerto Princesa, Palawan Island, 2079 Culion Island, 4866 Samal Island, Mindanao. Thirty-two specimens in all including types.

This species but slightly resembles *A. forskalii* (Rupp.) being a deeper, heavier fish with a caudal peduncle not nearly so deep and has fewer scales and anal rays. Evermann and Seale³ refer specimens from Bacon and Bulan to *A. forskalii* which probably belong to this species. This species somewhat resembles *A. duodecimalis* Bleek., but the shape and color markings are different, the rows of black dots on the sides being always present in our specimens. This species somewhat resembles *A. lineata* Gunther but the latter species has teeth on the palatines, a smaller eye, and different location of fins. *A. lineata* also has the pectoral slightly washed with dusky over its entire surface and the rows of dots are larger and more distinct.

³ Bull. Bur. Fish. (1906).

Family MUGILIDÆ. The Mulletts.

Mugil joloensis Seale, sp. nov. Plate IV.⁴ (Banak.)

Head 4.30; depth 3.60; dorsal IV, I, 7; anal I, 9; scales 33, 10 in vertical series; eye 3.30 in head; snout 4.10; interorbital space 1.95; maxillary exposed at tip; mandible 2.75; pectorals equal to head; ventrals 1.30; least depth of caudal peduncle 2.

Body moderately elongate, compressed, the greatest depth being in middle of body, the depth of the caudal peduncle is scarcely less than its length (measured to axil of dorsal). The profile from origin of spinous dorsal to snout is almost a straight line.

Interorbital space is moderately convex. Top of snout almost flat. Greatest width of head 1.45 in its depth. Depth of head at middle of eye 1.75 in length. Snout short and blunt. The preorbital has a very deep notch, its depth being greater than width of pupil. The upper lip is very thick, with a fold, and fringed with a row of papillæ, an additional row of papillæ on the lip just above the fold, an additional fringed fold at each corner of the mouth; under lip with moderately broad membrane. The nostrils are situated directly above the posterior margin of preorbital notch. Teeth on tongue, vomer, and palatine, none in jaws. Eye with but the slightest indication of adipose eyelid, which is present as a narrow rim to orbit. Snout is much broader than long, it is fully tipped by the broad maxillary. There are four soft differentiated areas between the scales on preopercle. Gill openings large being carried forward to under pupil. Gill rakers numerous slender, longest about equal to pupil. Pseudobranchia present.

Body and head covered with large smooth scales which are slightly ctenoid at margin. A single small ridge in center of each scale. About nineteen scales in front of dorsal fin; soft dorsal and anal scaled. Pectorals without axillary scale. An axillary scale at ventrals. Eleven rows of scales between the origin of the dorsals.

The spinous dorsal is midway between end of caudal vertebra and middle of pupil, the longest spine 1.70 in head. Origin of soft dorsal midway between end of last caudal vertebra and origin of first dorsal being over the middle of anal, its longest ray equal to longest anal ray, 1.50 in head. Origin of anal is slightly nearer end of caudal vertebra than to origin of ventrals. The ventrals are midway between anal and anterior margin of orbit. The upper portion of pectoral base is on a line with upper margin of eye. Caudal fin is rather deeply emarginate its length greater than head.

Color in alcohol silvery with wash of yellowish, grayish above. Upper third of pectorals washed with dusky; soft dorsal, anterior rays of anal, and tip of caudal also slightly washed with dusky. No stripes on body,

⁴ In our figure the spinous dorsal and the ventrals are drawn too far forward.

except those caused by the small ridge along center of scales. A distinct black dot at axil of pectorals.

Type is No. 2379. Secured by the writer at Jolo, Jolo Island, P. I., February, 1908. Length, 125 millimeters.

This species is related to *M. labiosus* C. & V., but *M. labiosus* has "upper lip without fringe." Our species has fewer scales, and the upper third of dorsals dusky, our species has teeth on vomer and palatine.

Mugil banksi Seale, sp. nov. Plate V. (Banak.)

Head 4.50; depth 3.50; dorsal IV, 9; anal III, 9; scales 37, 10 in vertical series; eye 3.10 in head, the exposed portion 4; snout 5; interorbital space 2; maxillary is entirely hidden; mandible 9 in head; preorbital with shallow notch, its end but slightly denticulate, its width at end 1.30 in pupil; pectorals equal to head; ventrals 1.30.

Body moderately elongate and compressed, the upper and lower outlines being about evenly curved to the short blunt snout. Tip of head formed by the deep upper lip. Caudal peduncle is thick and strong, its depth 1.25 in its length measured to vertical dorsal axil.

The head from the blunt snout is rounded conical; interorbital space convex. Eye is large with the adipose lid developed as a narrow fringe to orbit and not covering more than a third of the iris before and behind. Greatest width of head 1.45 in its length being almost equal to its greatest depth, width of snout is equal to twice its length and is much more than its depth. An elongate shallow depression on upper sides of snout containing the two nostrils, the posterior one much the larger. Upper lip thick, with two distinct rows of papillæ, these becoming united into little folds near the corners of the mouth. Lower lip thin, without papillæ. No teeth in jaws or mouth. Gill openings extend forward to below posterior margin of pupil. Gill rakers are short slender and numerous. The two margins of the subopercles fitting closely below, the space between them being confined to a short narrow line anteriorly. The mandibles cover the entire chin.

Head and body including soft fins scaled. The scales of body large, smooth, thin, margined with a thin soft membrane. A short narrow groove in the center of each scale, about 20 scales in front of dorsal fin and 13 series between the origins of the two dorsals. A distinct axillary scale at pectoral and ventral. Anal with scaly sheath. Five soft differentiated areas on the margin of the preopercle between the marginal scales.

Origin of spinous dorsal midway between tip of snout and end of last caudal vertebra, length of first spine 1.50 in head; origin of soft dorsal very little nearer origin of spinous dorsal than to end of caudal vertebra, being on a line with the third anal ray, its longest ray 1.30 in head. Origin of anal slightly nearer end of caudal vertebra than to axil of ventrals. The longest ray equal to longest ray of soft dorsal, base of

fin 1.70 in head. Origin of ventrals midway between origin of anal and notch of preorbital, caudal deeply emarginate, its length considerably greater than head.

Color in life silvery with a grayish wash above. The head with bronzy reflections. A distinct black spot at upper axil of pectorals and a rather broad and distinct white bar across the base of the fin below the dark spot. A white margin to anal pore. Fins whitish, soft dorsal and caudal slightly washed with dusky on posterior third.

Color in alcohol similar to above, but the groove on middle of scale showing more distinctly above and giving the appearance of narrow stripes on center of rows of scales.

Type is No. 1412. Secured at Siquijor Island, P. I., 7 September, 1908. Length, 190 millimeters.

This species is related to *M. longimanus* but is distinguished by the fringed lip, 9 anal rays, and smaller adipose eyelid, markings, and position of fins.

Named for C. S. Banks, entomologist Biological Laboratory, Bureau of Science, Manila.

Family SPHYRÆNIDÆ. The Barracudas.

Sphyræna aureoflammea Seale, sp. nov. (Babayo.)

Head 3.10; depth 6.35; dorsal V, 10; anal 11; scales 7-83-9 (counting to end of caudal vertebra); eye 5 in head (measured to tip of upper jaw); snout 2.25; interorbital space 1.75 in eye; maxillary 2.75 in head; mandible 1.75; ventrals 3.10; pectorals 2.75.

Body elongate, cylindrical, the upper and lower outline about evenly curved, length of caudal peduncle 1.50 in head, its least depth 3 in its length.

The head is elongate, conical, its greatest depth 2.75 in its length, greatest width 3. Upper profile of head is almost straight; the interorbital space is flat, with 4 distinct ridges. The opercle ends in a single obtuse flat point. The lower angle of preopercle extends back as a large membranous flap. The eyes are of moderate size. Snout is conical, its median width being somewhat greater than its median depth. Preorbital with a distinct oblique ridge in front of the eye. Maxillary falls short of the eye by a distance equal to pupil, the maxillary ends in a small but distinct spine. The lower jaw considerably the longer. Teeth of upper jaw consist of a single row of small teeth on sides of palatines with three enlarged canines a short distance from tip of jaw, and two enlarged canines on each side at tip of jaw, the maxillary also has a single row of small teeth. Teeth of lower jaw a single series of rather strong canines. A single large canine at symphysis. No teeth on vomer. Gill openings large, ending on a line with anterior margin of eye. Two gill rakers on lower limb, one being at the angle, these are distinct, sharp, pointed, their length 2 in pupil.

Body entirely covered with large smooth scales, about 23 in front of dorsal, and 31 between the origins of the two dorsals. The fins, except spinous dorsal, are more or less scaled. Head is naked except on nape, cheeks, and opercles; lower limb of preopercle naked, no scales on head in front of anterior margin of pupil.

Origin of spinous dorsal midway between origin of second dorsal and posterior margin of pupil, being above the middle of the ventral rays, the anterior spines longest, being equal to postocular portion of head. Origin of second dorsal considerably nearer the first dorsal than to end of caudal vertebra. Origin of anal is under the second dorsal ray and is slightly nearer end of caudal vertebra than to origin of ventrals. Base of soft dorsal slightly greater than base of anal which is 3.75 in head. The longest dorsal ray and longest anal ray about equal, 3.10 in head. Origins of ventrals midway between middle of maxillary and anal fin. Caudal deeply emarginate, the lobes 2 in head.

Color in life, above lateral line lemon-yellow, a purplish stripe from snout over interorbital space and nuchal region to near base of second dorsal, a short stripe with some yellow edgings in front of eye. A brown stripe from origin of lateral line to middle of base of caudal, another line from posterior margin of eye over base of pectorals to caudal, the area between these two lines rather a bright blue, ventral surface a pale blue. Some greenish scales with yellow margins on nuchal region, lips brown, soft dorsal with slight wash of brown, caudal yellowish brown, anal with a slight trace of pink, other fins white.

Color in alcohol dull brownish above, silvery below; two brown lines on sides; top of head and snout darker; soft dorsal and caudal grayish, pectoral more or less grayish at axil.

Five specimens. Type is No. 4138, from Zamboanga, Mindanao, 22 May, 1908. Length, 280 millimeters.

Family SYNGNATHIDÆ.

Trachyrhamphus caba ⁵ Seale, sp. nov.

Head 4 in body (measured from tip of snout to anal opening); greatest depth equal to postocular portion of head; dorsal 22, its base occupying 4 rings which are swollen, thus the base of the fin is considerably elevated above the level of the dorsal surface; body with 18 rings, tail with 33 rings. The dorsal is located on two of the tail rings and two of the body rings; anal 4; snout equal to distance from pupil of eye to posterior margin of opercle; eye 4 in head; interorbital equal to eye; pectorals 1.75 in snout; caudal 1.50 in snout, its tip rounded; length of body and head equal to 21 rings of caudal; lateral line passes to lower caudal edge which is strongly scalloped; nuchal region has a decided crest; snout strongly depressed, being in line with lower margin of body,

⁵ *Caba* is the native name for this fish.

the forehead has an abrupt curve, formed by the pronounced ocular ridges; interorbital space deeply concave; opercles with numerous fin-shaped striae, which radiate from a single larger longitudinal ridge; ten distinct ridges in the interorbital space which unite and form one on the snout, this ridge has a few small spines; the orbital ridge is also spinate; rings of body and tail without spines; length of dorsal rays less than width of opercle.

Color brown, the three anterior caudal rings lighter, the ventral surface of body rings and opercles brown, with the yellow cross lines on their under surface, these cross lines not extending on body rings; snout brown above and white below. A brown ring near the tip, fins grayish without markings.

Type is No. 2324 from Balayan Bay, Luzon, 20 January, 1908. Length, 140 millimeters.

Family HOLOCENTRIDÆ. The Squirrel Fishes.

Myripristis schultzei Seale, sp. nov. (Baga baga.)

Head 3.10; depth 2.50; dorsal X, 1, 15; anal III, 13; scales 28 to end of vertebra, 10 in vertical series; eye large, 2 in head; snout 7.50; interorbital space 3.30; maxillary 1.80, its posterior tip ending on a line with posterior margin of pupil, width of distal end 2 in eye; mandible 1.60 in head; pectorals 1.25; ventrals 1.45.

Body oblong, compressed, greatest width at origin of dorsal. Upper and lower outlines of body about equal. Length of caudal peduncle 2.50 in head, its depth 3.10. Depth of head about equal to its length, its greatest width 1.50 in its length; interorbital space flat with 4 longitudinal ridges. The anterior outline of head is bent rather abruptly down in front of eyes making a short blunt snout, the length of which is 2 in its width. The groove to receive the maxillary process ends on a line with anterior of eye. Preorbital is narrow and denticulate, its greatest width 3 in interorbital space; opercular bones are denticulate, the opercle has a single flat spine on its posterior margin, maxillary with small teeth on its lower posterior border. Mouth large, oblique, lower jaw slightly the longest. Four distinct pores on tip of lower jaw; bands of villiform teeth in jaws, vomer, palatin, and on hyoid portion of tongue. A few large exterior teeth on the outside of each jaw, more abundant and larger on lower jaw. Gill openings very large being carried forward to below anterior margin of pupil. Gill rakers rather long, about 30 on lower arch, the longest 2 in eye. Pseudobranchia present.

Scales are large and toothed; body fully scaled; head naked except about 3 rows of scales on cheeks; ventral with distinct axillary scale.

Origin of dorsal fin midway between tip of snout and third anal ray. Fourth spine the longest, 1.85 in head. Anal and soft dorsal similar,

the anal rays are slightly the longest, being 1.30 in head. Third dorsal spine is slightly the longest being 2.30 in head, both the soft dorsal and anal are sharp pointed.

Origin of ventrals midway between anal and anterior margin of eye, caudal forked, 1.10 in head.

Color in life pinkish, washed with violet above, the margins of scales on sides with brighter red, tip of lower jaw and snout red. Margin of spinous dorsal deep red, the body of fin pale red, anterior of soft dorsal and anal broadly margined with deep red. Tip of caudal deep red shading into lighter red at base. No opercular blotch, some deeper red on base of pectorals, inner axil of pectorals deep black.

Color in alcohol yellowish white with some bronzy reflections, darker above; fins uniform yellowish white; no opercular blotch; inner axil of pectorals deep black.

Type is No. 3899 taken at Samal Island, Gulf of Davao, P. I., 4 May, 1908. Length, 160 millimeters.

This species is related to *M. violescens*.

Family CARANGIDÆ. The Pampanos.

Caranx auriga Seale, sp. nov. Plate VI. (Talakitok.)

Head 3.30 in length; depth 2.75; dorsal VII, I, 17; anal II, I 16; 35 armed scutes constituting the straight portion of the lateral line, about 70 scales in curved portion of line, curved portion 1.35 in straight, greatest depth of curve 4.25 in head, the line becomes straight under the third dorsal ray; eye 3.50, the adipose eyelid covering the posterior third of eye and a narrow margin anteriorly; snout 4.20; interorbital space equal to eye; maxillary 2 in head, its end under posterior margin of iris; width of its distal end 1.50 in eye; ventral 2.10 in head; least depth of caudal peduncle 2.40 in eye, its width scarcely less than eye.

Body oblong, moderately compressed, the depth at the origin of spinous dorsal and at soft dorsal equal; the lower outline from the origin of anal rays to mandible is a straight line, the mandibles being placed at a very low angle. The upper outline from origin of soft dorsal to tip of snout is curved, the snout being at an angle much greater than 75°. The length of caudal peduncle (measured from upper origin of caudal rays to axil of dorsal) is but little more than its width, its depth is 2 in its length. Upper profile of head strongly rounded, a distinct ridge from occiput to nostrils, the snout is placed at a steep angle. Width of preorbital 1.60 in eye; greatest width of head 1.85 in its length; eye of moderate size, the adipose lid covering the posterior portion up to pupil, a very narrow anterior adipose lid. Lower jaw is slightly projecting, each jaw has rather wide membraneous lips; maxillary with strong supplemental bone. Each jaw with moderately strong curved canines, the upper jaw with an inner row of villiform teeth. Villiform teeth on vomer,

palatines, and tongue. Gill opening wide, being carried forward to a line with the anterior margin of eye; gill rakers rather strong and saber-like, 14 on lower limb, the longest about 1.50 in eye. Pseudobranchia present.

Scales small, rather smooth, breast fully scaled, head naked except on cheeks and nape. The scutes are graduated in size from middle of caudal peduncle, their greatest depth being slightly less than pupil, their size at beginning of straight portion of lateral line very minute.

Origin of spinous dorsal slightly posterior to axil of pectoral, the spines weak, the second spine the longest being 3.40 in head, the last dorsal spine is free. The soft dorsal and anal are quite similar the rays being of about equal length, the longest being 3 in head, base of anal slightly less than base of soft dorsal, the origin of the anal rays being under the fifth dorsal ray; the last anal ray is slightly prolonged. Anal spines are under origin of soft dorsal; ventrals are about midway between tip of snout and origin of anal rays; their tip reaching to anal pore. Pectorals long and falcate, their tip reaching to fifth anal ray. Caudal strongly forked, two narrow ridges on its base, one on each side of the scutes, length of fin slightly less than head.

Color in life silvery with bronze wash and golden reflections, soft dorsal, anal and caudal yellow, a rather large, not very dark and somewhat diffused opercular spot at origin of lateral line, a black spot on inner axil of pectoral not showing on outer surface.

Color in alcohol similar to above but dull silvery on upper half, yellowish white below. Head with bronze reflections, fins yellowish white, without dark markings except a slight trace of brownish on tip of spinous dorsal and on tip of upper half of caudal.

Type is No. 30. Secured at Manila, P. I., 31 May, 1907. Length, 230 millimeters.

Caranx butuanensis Seale, sp. nov. Plate VII.

Head 3.75; depth 2.50; dorsal VIII, I, 21; anal II, I, 17; scales small; 43 scutes in straight portion of lateral line, and about 70 scales in curved portion, the curved portion contained 1.50 in straight, the greatest depth of the curve about equal to eye. The lateral line becomes straight under the sixth dorsal ray; eye 3 in head; snout 4; interorbital space 3 in head; maxillary 2.1, ending slightly posterior to pupil, width of its distal end 1.50 in eye; mandible 1.85 in head; pectorals 3.30 in body; ventrals 1.85 in head; least depth of caudal peduncle 2 in eye. Body oblong compressed, its greatest depth at origin of soft dorsal, the lower outline from origin of anal rays to tip of lower jaw is a low even curve. The upper outline from origin of soft dorsal to tip of snout is an irregular curve being deeply concave at the occiput, causing the head to be of considerable less depth than in most species of the genus. Length of the caudal peduncle is about a fourth greater than its width. Upper profile of head with a ridge from origin of dorsal to nostril. The snout

is at an angle of a little more than 45° . Greatest depth of head slightly less than its length, its width 2 in length. Mouth is of moderate size, the lower jaw slightly the longest, distinct membranous lips on each jaw, a large supplemental bone on maxillary. Width of preorbital about 2 in eye. Teeth of lower jaw small, in two or more rows, with some large canines anteriorly. Teeth of lower jaw consisting of a single row of rather small canines, teeth on vomer, palatines, and tongue. Gill openings large, being carried forward to below anterior margin of eye. Gill rakers saber-like, 16 on lower limb, the longest about 1.50 in eye. Pseudo-branchia present.

Scales are small, smooth, and fully cover the body, including breast. Head is naked except on cheeks and occiput. The scutes are graduated from the caudal peduncle, the deepest being 1.75 in eye, those at the beginning of straight portion of lateral line minute.

Origin of spinous dorsal slightly posterior to axil of pectoral, the third spine longest, 2.45 in head; the last dorsal spine free. Soft dorsal and anal similar, their longest rays being about equal, 1.85 in head, the last ray of each fin slightly prolonged.

Base of soft dorsal slightly the longest, the origin of anal being under the sixth dorsal ray. Anal spines are below origin of soft dorsal. Origin of ventrals midway between tip of snout and origin of first anal ray. Pectorals falcate, their tip scarcely reaching to anal rays. Caudal forked with the two ridges on base almost obsolete, length of fin slightly less than head.

Color in life silvery below, with about 7 wide dusky bands over the back and down on sides, these bands of much greater width than the interspaces, bands of equal width. Fins yellowish white, except spinous dorsal which has a slight wash of grayish. A dusky opercular spot.

Color in alcohol silvery with slight bronzy reflections, 7 dusky bands on back, the first being on nuchal region and the last on caudal peduncle. A dusky opercular spot. Top of head with some grayish, fins yellowish white except spinous dorsal, which has a slight wash of gray, there is also a very slight trace of grayish on tip of soft dorsal. Inner axil of pectorals dusky, no dusky on their base. Iris golden with dusky blotch on upper margin.

Type is No. 1896, taken at Butuan Bay, Mindanao Island, P. I., 25 September, 1907. Length, 120 millimeters.

Family APOGONICHTHYIDÆ.

Amia magnifica Seale, sp. nov. (Daugat.)

Head 2.75; depth 3; dorsal VI, I, 8; anal II, 7; scales 24, lateral line complete; 7 scales in vertical series; eye 2.75 in head; snout 3.50; interorbital 1.50 in eye; preopercle distinctly denticulate; bands of villiform teeth in jaws, vomer, and palatines.

Body oblong, compressed, the greatest depth at origin of dorsal; caudal peduncle rather long and slender, its depth 2.50 in head, its length 1.45. Upper outline of body more strongly curved than lower. Head pointed, mouth large, lower jaw projecting; eye large, interorbital space slightly convex with two ridges, which unite into one midway between eyes. Tip of maxillary extends to a line with pupil, its distal margin concave, its length 2.10 in head.

Gill openings large, extending forward to below pupil. Gill rakers rather slender not very pointed, about 19 on lower limb.

Body covered with large smooth scales, cheeks and opercles scaled.

Origin of dorsal midway between middle of caudal peduncle and tip of of snout, its second spine the longest, 1.80 in head, last dorsal spine almost as long as first ray, the longest ray 2.70 in head; caudal slightly lunate. Origin of ventrals midway between base of caudal and pupil, its second spine about two-thirds length of rays, its longest ray 1.75. Origin of ventrals midway between anal and a line with nostril, their tip reaching almost to anal, their length 1.50 in head. Pectorals 1.75 in head.

Color in life. A bright cardinal red with five silvery longitudinal lines, the middle one being composed of round silvery spots. These lines are arranged as follows: the first is from tip of snout through upper part of eye back to below anterior third of dorsal where it unites with the second line, the portion of this line on the snout is orange, the remainder is silvery; the second line is from posterior of eye to caudal, the portion on the opercle is margined above and below with dusky; the third line is from the lower posterior portion of eye to caudal, this line on the opercle is also margined with dusky, and posterior to opercle it is composed of round silvery dots; the fourth line is from maxillary below eye to lower margin of opercle, this line is margined with dusky; the fourth line extends from the lower posterior portion of opercle to the caudal; the fifth line is below this and forms the general white coloring of the belly, to anal fin. The fins are all uniformly red. Top of head with orange stripe from interorbital space along base of dorsals; chin orange, tip of jaws brownish.

Color in spirits. The bright cardinal fades into dull brownish, the silver becomes pale yellow, the orange fades into dull yellow, the opercles show a beautiful, opalescent bluish reflection, the black on tip of jaw and a black line on snout fade into white; the dusky margins to the stripes on head show more distinctly, the lines on interorbital being bluish white ending on nuchal region. A slight black area on middle of caudal base, fins yellowish white.

Numerous specimens. Type is No. 5192, from Balabac Island, 10 August, 1908. Length, 40 millimeters.

Amia cardinalis Seale, sp. nov.

Head 3; depth 2.75; dorsal VI, I, 9; anal II, 8; scales 24, the lateral line complete, $7\frac{1}{2}$ scales in vertical series; eye 2.75 in head; snout 4; interorbital 1.50 in eye; maxillary 2 in head, its distal end on a line with posterior margin of iris; mandible 1.55; posterior margin of preopercle strongly denticulate.

Teeth in villiform bands in jaws, vomer and palatines.

Body oblong, compressed, the greatest depth at origin of dorsal, caudal peduncle rather long and thin, its depth equal to orbit, its length 1.20 in head. Upper outline of body more strongly curved than lower. Head rather bluntly pointed, mouth large, cheeks and opercles each with two rows of scales, opercle with a sharp flat spine. Gill openings wide, being carried forward to a line with the pupil. Gill rakers short and sharp pointed, about 13 on lower limb. Body fully covered with large smooth scales which have very finely toothed borders, head without scales except on cheeks and opercles.

Origin of dorsal fin is midway between tip of snout and middle of caudal peduncle, its second spine is the longest and strongest, its length 1.50 in head. The last dorsal spine scarcely more than half the length of the first ray which is 1.75 in head. Caudal slightly bilobed, 1.25 in head; origin of anal midway between end of last caudal vertebra and distal end of maxillary, its longest spine about equal to orbit, its longest ray 1.75 in head. Origin of ventrals midway between anal and a line with middle of pupil, their length 1.50 in head; pectorals 1.40 in head.

Color in life uniform bright cardinal, without stripes or bands; a slight tint of yellow on side of belly, and a brownish blotch on opercles just posterior to eye, fins all uniform red.

Color in alcohol uniform yellowish white, some dusky marks at base of dorsals. A slight opalescent tint on opercle. A brown spot on nuchal region, fins uniform yellowish white.

Type is No. 5463 from Puerto Princessa, Palawan Island, P. I., 21 August, 1908. Length, 40 millimeters.

This species seems to differ in several respect from *A. erythermus* to which it is most nearly related.

Family SERRANIDÆ.

Epinephelus albimuculatus Seale, sp. nov. Plate VIII. (Lapo lapo.)

Head 2.65 (measured from tip of jaw to tip of opercular flap); depth 3.35; dorsal XI, 16; anal III, 8; scales about 120 in lateral series, 50 in vertical series, about 50 pores in lateral line; eye 5.80 in head; snout 4.45; interorbital 7.10; maxillary 2.14, extending posterior to eye; mandible 1.80.

Body oblong, compressed, rather slender and elongate for this genus,

the upper outline considerably more curved than lower. Least depth of caudal peduncle 3.30 in head, caudal truncate.

Anterior profile from origin of dorsal to tip of snout has a gradual even curve. Lower jaw rather strongly projecting. Mouth large. Each lip with a fold. Upper jaw without teeth directly in center of jaw, but with a patch of small sharp teeth on each side of symphysis. A single, small projecting canine on each side; extending back on the jaws from each anterior patch are several rows of villiform teeth with an outer row of enlarged canines. Under jaw with bands of cardiform teeth anteriorly with a projecting canine on each side (broken in type) the side of lower jaw with two rows of enlarged teeth, the anterior row of larger depressible teeth. Bands of villiform teeth on vomer and palatine. Tongue spatulate, without teeth: preopercle rounded and finely toothed, a slight notch near its angle below which the teeth are slightly enlarged. Soft portion of opercle ending in a single sharp point, the hard portion of opercle with three spines the middle one being much the largest in fact the only conspicuous one, the upper one being obtuse and hidden, and the lower one very small, the middle spine is the most posterior and its tip is nearer tip of lower than to upper spine. Gill openings large, being carried forward to below anterior portion of eye. Gill rakers large and strong, 16 on lower limb, the longest equal to two-thirds diameter of eye. Scales are minute and ctenoid; body, head, and fins, except jaws and posterior portion of maxillary, finely scaled: the scales on under surface and on nuchal region smallest.

Origin of dorsal midway between tip of snout and third ray of dorsal, the third to fourth spine longest, 2.40 in head, the first spine 1.90 in second, the longest ray 2.75. Origin of anal slightly nearer to last caudal vertebra than to angle of preopercle, its third spine the longest, 3.75 in head, its longest ray 2.10 in head. Ventrals 2 in head, their origin midway between anal and a vertical line with posterior nostril. Pectorals 1.75 in head.

Color in life brownish with tint of green, about 30 rather large scattered round yellow spots on head, fins slightly darker, otherwise color uniform.

Color in alcohol. Uniform brown with scattered round whitish spots on head, about 30 on each side and 4 or 5 showing indistinctly on shoulders, above lateral line, fins dark brown, uniform, the pectorals a shade less dusky.

Type is No. 1908 from Butuan Bay, Mindanao, P. I., 26 September, 1908. Length, 280 millimeters.

This species is related to *E. coromandelicus* Day but differs in several respects, being more elongate and having a longer maxillary, a slightly different arrangement of opercular spines, and a different color pattern.

Family HEMULIDÆ.

Plectorhynchus doanei Seale, sp. nov.

Head 3; depth 2.40; dorsal XI, 20; anal III, 8; scales about 75; 64 pores in lateral line; about 30 scales in vertical series; eye 3; snout 3; interorbital space 4; maxillary 3.75, scarcely reaching to anterior margin of eye; mandible 2.75.

Body is oblong, compressed, the upper outline with much stronger curve than lower, the greatest depth is at origin of ventrals. Depth of caudal peduncle 2.75 in head, its length 1.80.

The anterior profile from origin of dorsal to end of snout is a strong curve, the snout however is almost straight and at an angle of more than 45°. Mouth small, lips thick, with fold. Teeth of upper jaw mostly anterior in several rows, small, sharp pointed. Teeth of lower jaw similar, except that those on sides of jaws are in single series. No teeth on vomer or palatine. Posterior margin of preopercle rather strongly denticulate. A rather deep notch on posterior margin of opercle. Gill openings wide, being carried forward to below anterior margin of eye. Gill rakers short, fine, almost hair-like, 26 on lower limb. Pseudobranchia present. Entire body and head, including also bases of all the soft fins covered with fine ctenoid scales. Origin of dorsal midway between tip of snout and base of sixth dorsal ray. The third or fourth spine longest, 1.75 in head, the eighth, ninth and tenth spines are shorter than the first spine, being less than length of snout. Longest dorsal ray 1.35 in head. Origin of anal midway between end of last caudal vertebra and the middle of base of pectorals, its base 2.50 in head, its second spine is much the longest and strongest, its length 1.75 in head, the longest ray 1.40 in head. Caudal forked, 1.1 in head, its lobes rounded; ventrals nearer to angle of mouth than to anal, their length 1.10 in head; pectorals equal to head.

Color in life orange red with about 7 large white areas margined with black, the anterior one occupies the snout, the second the nuchal region, extending down to opercles on each side but not to base of dorsal, the third occupies a region from origin of gill openings to, and including base of ventrals and obliquely up to eye, there is a square red band in the middle of this area across the thorax. There is a dark ocular band about width of eye down from eye around base of lower jaw, the fourth white area is a round spot back of, and above, base of pectorals, the fifth is below seventh to ninth dorsal spines and includes these spines, the sixth just above and includes the origin of anal, the seventh is an oblique white ring occupying the outer two-thirds of caudal peduncle. The posterior two-thirds of caudal is white with an oblong dusky patch on each lobe, the sixth and seventh white areas have an indistinct round dusky spot in the center. The soft dorsal is dusky with margins of

rays white and a white spot near middle of fin. Anal is dusky at base, broadly margined with white, with some dusky blotches at tip. Ventrals black, with a white spot on anterior ray. Pectorals black with white tips.

Color in alcohol similar to above, except that the orange fades into a light brown, the black margins to the white areas remain very distinct.

Type is No. 4760 from Sitanki Island, Jolo Archipelago, 15 July, 1908; length, 40 millimeters; also a specimen No. 1695 from Cagayan, Mindanao.

Family THERAPONIDÆ. The Grunts.

Dentex filiformis Seale, sp. nov. Plate IX.

Head 3.75; depth 1.15; dorsal X, 9; anal III, 7; scales 3-47-16; eye 3 in head; snout 3.10; interorbital space equal to eye; maxillary 3; mandible 2.35; pectorals 1.25 in head; ventrals 1.30; depth of caudal peduncle 3.

Body moderately elongate, oblong, compressed, of about equal depth at origin of pectorals and at anal pore; least depth of caudal peduncle 3 in head.

Head somewhat conical, the profile from nape to snout evenly curved, the interorbital space is moderately convex. Greatest width of head 1.85 in its length. Snout rounded, its width at anterior nostril equal to its length; jaws equal, the upper moderately protractile, each jaw with a rather wide fold or lip. Maxillary fully hidden except at its tip, premaxillary scarcely reaching to eye, preorbital notched at angle of jaw, its width at this point equal to pupil, no spine on its posterior margin. Lower jaw with two distinct pores on each side, mouth wide, slightly oblique. Curved canines in each jaw, with patches of inner villiform teeth anteriorly, the fourth anterior canine of upper jaw largest. No teeth on vomer, palatine, or tongue. Preopercle fully serrated, opercle with a single rather distinct spine; five rows of large scales on cheeks. Head, except snout, preorbital, and under jaw, fully scaled. Gill opening wide, being carried forward to a line with middle of eye. Gill rakers consisting of short, thick asperites, about 4 on lower limb. Pseudobranchia present. Eyes quite large.

Scales small and ctenoid, the rows running horizontally on upper third of fish and obliquely below, body fully scaled; five distinct rows of scales on cheeks with the addition of a few scattered scales at margin of orbit.

Dorsal fin continuous, the spines weak, the fourth and fifth spines the longest, 2.50 in head, the longest ray 1.95 in head, the fin is provided with a distinct groove into which it fits, its origin is directly above the axil of pectoral. Origin of anal on a line with base of second dorsal ray and is midway between end of caudal vertebra and origin of ventrals, the anal spines are graduated, the third being 3.75 in head, longest ray 2.75, base of fin 1.90 in head. Origin of ventrals slightly nearer tip of

snout than origin of anal, its length 1.30 in head. Pectorals 1.30 in head, caudal forked with the outer rays of upper lobe filliform, its length 2.35 of body, the lower lobe 1.30 in head.

Color in alcohol yellowish, a wide brown band slightly less than width of eye, occupies the middle of sides from eye to caudal. A yellowish area above this band, the entire upper portion brown, a round dusky dot at posterior end of lateral line, snout dark brown. There is a slight indication of an additional but very indistinct dusky band on upper sides of belly fading out posteriorly. Fins all uniform, yellowish white without markings.

Type is No. 1755 from Surigao, Mindanao, P. I. taken 17 September, 1907. Length, 130 millimeters.

Family LUTIANIDÆ. The Snappers.

Lutianus orientalis Seale, sp. nov. (Mayamaya.)

Head 2.75; depth 2.80; dorsal X, 14; anal III, 8; scales 8-51-14; eye 3.75; snout 3.10; interorbital 5.25; maxillary 2.30, ending under anterior third of pupil; mandible 1.75 ending on a line with posterior margin of pupil; pectorals 1.30; ventrals 1.55.

Body oblong, compressed, the greatest depth at origin of spinous dorsal. The upper outline from axil of dorsal to eye is an even curve; outline of head at eyes slightly concave. The lower profile from anal to chin is almost straight, the lower jaw being at a low angle. The length of the caudal peduncle is 1.80 in head, its greatest depth 1.25 in its length. Interorbital space slightly convex, a median ridge along its center; snout conical; width of preorbital but slightly greater than pupil. Jaws equal. Teeth consisting of villiform bands with outer row of curved canines, and a very long and strong anterior canine on each side of upper jaw. Teeth on vomer and palatine, none on tongue. A very shallow preopercular notch, no opercular knob, opercle ending in a flat spine. Gill openings wide, ending under anterior margin of eye. Gill rakers of moderate length, sharp-pointed, ten on lower limb, the longest about equal to pupil. Pseudobranchia present. Body fully scaled, cheeks, nape and opercles scaled, soft dorsal, caudal, anal and pectoral scaled at base.

Origin of dorsal above axil of pectoral, the fourth spine the longest, 2.50 in length; longest dorsal ray 2.30 in head; second anal spine slightly the longest, 2.75 in head; longest anal ray 2.10 in head. Origin of anal under second dorsal ray; origin of ventrals, midway between tip of snout and fourth anal ray, their spine only about half length of rays. Pectorals not reaching to anal. Ventrals extend to anal pore. Caudal scarcely emarginate, its length 1.35 in head.

Color in life yellow, darker above, four wide black longitudinal stripes of almost the width of pupil at their median point, the first from snout

through interorbital space to posterior base of spinous dorsal. Second from posterior margin of eye to base of soft dorsal. Third from tip of snout through eye to upper base of caudal, a large black ovate spot in this line and extending above it, below the anterior portion of soft dorsal. Fourth from suborbital to lower base of caudal through the upper axil of pectoral, there is a slight dusky wash on tips of spinous dorsal and caudal, otherwise fins yellowish white.

Color in alcohol similar to above except the lines on top of head do not show, and the general color is dull yellowish white, brownish above with the black lines and black blotch showing very distinctly.

Four specimens; type is No. 2201 from Limbones Cove, Island of Luzon, P. I. Length, 95 millimeters, 14 January, 1908. The three additional specimens are from Balabac Island, P. I.

This fish was called *L. russeli* by Jordan & Seale and *L. quinquelineatus* by Jordan & Richardson. Day gives it as the young of *L. chrysotania*, but we have specimens of *chrysotania* and there is no doubt of it being a different fish. I have examined specimens of the two former species in the Stanford University Collection and find it can not be classed with either.

Family SPARIDÆ. The Porgies.

Lethrinus cutambi^a Seale sp. nov. Plate X. (Cutambak.)

Head 3; depth, 2.75; dorsal X, 9; anal III, 8; scales 6-45-13; eye 4; snout 2, width of maxillary at symphysis almost equal to pupil; its length 2.75 in head; mandible 2.45; width of preorbital 2.95; pectorals 1.20; ventrals 1.50; interorbital space 1.10 in eye.

Body oblong compressed, the greatest depth being at origin of ventrals. The upper outline of body from occiput to axil of dorsal is an even curve, the forehead in front of eye is slightly convex while the snout is decidedly concave, the lower outline of body much less curved than upper; the lower jaw being very slightly oblique. The length of the caudal peduncle is 2 in head, its median width is 3.50 in its length, while its depth is 1.50 in its length.

Greatest depth of head slightly less than its length, its greatest width 2.20 in its length; interorbital space convex. Snout is elongate, its median width being about 2 in its length, nostrils some distance apart, the anterior one with membranous flap. Mouth large, the lips with thick membranous folds. The upper jaw strongly protractile. Teeth of upper jaw consisting of a single row of about six conical molars without cusps on each side, with small conical canine-like teeth anteriorly and with four enlarged outer canines in front. Lower jaw with about eight conical molars without cusps, and small canines, anteriorly, two enlarged outer canines on each side in front. No teeth on vomer,

^a From the native name of this fish.

palatine or tongue. The jaws are equal, the maxillary ends on a line with anterior nostril, its end is fully hidden by preorbital. The mandible ends on a line with posterior nostril. Gill openings are of moderate size being carried forward to a line with middle of eye. Gill rakers are thick and short 5 on lower limb, the longest about one-fourth of pupil. Pseudobranchia present.

Body fully covered with rather large smooth scales which are very slightly denticulate on margins. Fins are unscaled, except pectorals which are slightly scaled at base. Head is naked except on opercles, with a small patch of scales behind and posterior to the eye, another small patch posterior to, and slightly above eye.

Origin of dorsal is one spine anterior to a line with axil of pectorals; fourth dorsal spine the longest, 3 in head, the spines received into a sheath, longest dorsal ray 2.50 in head.

The second anal spine is strongest, the third is the longest being 3.10 in head, longest anal ray 2.75, origin of anal is on a line with the second dorsal ray. Origin of ventrals midway between tip of snout and fifth anal ray. Tip of ventrals reaching to anal pore. Pectorals extend to a line with origin of anal. Caudal deeply emarginate, its length 1.25 in head, its shortest ray 2.10 in head.

Color in life rather a dark greenish with 7 or 8 irregular darker vertical bars over back and down on sides. Vertical fins marked with bars of dark green.

Color in alcohol yellowish, with slight shades of greenish, about 8 irregular darker greenish bars extending over back and down on sides to ventral surface, these bars much less than the interspaces, the bands are more or less broken at the lateral line but are continuous below it, there is on the second of these bands above middle of pectorals and below the lateral line an intensified dusky area or blotch, scarcely distinct from coloring of bands. Head is brownish with tint of green, there is a darker band easily overlooked, from lower half of eye down to posterior end of mandible; posterior margin of opercle darker. A darker green line at base of pectorals. A mottling of darker green on the membrane at base of each dorsal spine, each ray of soft dorsal and anal is crossed by one or two darker green blotches. Caudal has three or four darker green vertical bars. Ventrals are crossed by three bars of darker green, pectorals white.

Type is No. 4678, taken at Sitanki Island, Jolo Archipelago, P. I., 11 July, 1908. Length, 210 millimeters. Cotype No. 4680.

Lethrinus atkinsoni Seale, sp. nov. Plate XI. (Cutambak.)

Head 2.90; depth 2.50; dorsal X, 9; anal III, 8; scales 5-48-13; eye 3; snout 2; interorbital space 1.15 in eye (bony part only measured); maxillary 2.50 in head; mandible 2.10; pectorals equal to head; ventrals 1.45.

Body is oblong, compressed, rather deep, greatest depth at origin of ventrals. The upper outline is an even curve to the anterior margin of eye, it is slightly more convex from this point, the practically straight snout extends down to the protractile upper lip, at an angle slightly greater than 45° . Lower outline from anal to tip of snout forming a low even curve, the lower jaw being but slightly oblique. The depth of caudal peduncle is 1.50 in its length, its median width is 3 in its length, while its length is 2 in head. Greatest depth of head equals its length, its greatest width 2 in length; interorbital space slightly convex. Outline of snout almost straight, excluding the protractile upper jaw; width of upper lip at symphysis 2.50 in pupil; maxillary ends slightly posterior to anterior nostril; the mandible ends on a line with anterior margin of eye. Eye is large, 1.50 in snout. Preorbital 2.50 in head, jaws equal. Teeth of upper jaw consisting on each side of three large molars, two of which have cusps, five conical teeth, and two large curved anterior canines, also a patch of minute teeth in anterior of jaw, behind the canines. Lower jaw on each side with four large molars, three of which are bicuspid, five conical teeth, two canines, and a patch of minute teeth just inside the curved anterior canines. No teeth on vomer or palatines, opercle ends in a flat spine and has a rather broad yellow membranous margin.

Gill openings end on a line with middle of eye, the gill rakers are short, thick and blunt, four on lower limb, the longest less than one-fourth of pupil. Pseudobranchia present.

Body entirely covered with large smooth scales which are slightly denticulate on margins; head naked except on opercles and a small patch of scales behind and above eye. The spinous dorsal when collapsed is fully hidden in scaly sheath. Fins not scaled except base of pectorals and caudal. Origin of dorsal is directly above axil of pectoral, its fourth to fifth spines are longest, 2.75 in head. Longest dorsal ray 2.25 in head. Origin of anal is over second dorsal ray, its third spine is the longest, 3.25 in head, the second spine is strongest. Longest anal ray 2.75 in head. Origin of ventrals midway between tip of snout and posterior axil of anal. Tips of ventrals reach to anal pore. Tips of pectorals extend to base of anal. Caudals deeply emarginate, its longest lobe 1.20 in head, its shortest ray 2.30.

Color in life yellow, with slight wash of grayish, fins immaculate, except ventrals which have dusky tips and caudal which is washed with yellow.

Color in alcohol whitish, slightly grayish drab above; the middle of each row of scales darker, making 4 or 5 narrow longitudinal lines above the lateral line, these rows follow the curvature of the back. A large rather indistinct oblong dusky blotch between the pectoral and lateral line, base and upper axil of pectoral grayish. The fins are white,

unmarked except the upper surface of the first ray of pectorals which is gray, and the ventrals, which have some dusky on their posterior third.

Type is No. 5080 taken at Balabac Island, P. I., 6 August, 1908. Length, 220 millimeters.

Family POMACENTRIDÆ. The Damsel-fishes.

Pomacentrus tropicus Seale, sp. nov. Plate XII, fig. 1. (Danigsalasa.)

Head 3; depth 1.95; dorsal XIII, 14; anal II, 14; scales 24, eighteen pores in lateral line, 12 in vertical series; eye 3 in head; snout 3.75; interorbital space 2.75; maxillary 3.50; mandible 3.10; pectorals equal to head posterior to nostril; ventrals slightly longer than pectorals; depth of caudal peduncle 2.10.

Body oblong, compressed, its greatest depth at origin of ventrals, this depth being considerably greater than at origin of anal. Depth of caudal peduncle greater than its length.

Anterior profile from origin of dorsal to tip of snout, is strongly rounded with a very slight constriction on nuchal region. Lower profile not quite so strongly rounded as upper, jaws when closed are equal. Interorbital space evenly convex. Greatest width of head 1.50 in its greatest depth. Snout rounded, its median width being a third less than its depth, its width considerable greater than its length, numerous small pores on top of snout and on orbital ring. Preopercle strongly denticulate, narrow but becoming abruptly wide under anterior margin of orbit, this wide portion ending posteriorly below in one or more strong spines, its anterior margin with a shallow notch; width of preorbital, at angle of mouth, 2 in eye, width below middle of eye, 1.50 in pupil. Maxillary scarcely extending to the anterior margin of orbit; mandible ending under anterior margin of orbit. Teeth in a single row in jaws. They are rather strong and incisor-like, 18 on each side of upper jaw; no teeth on vomer or palatine. Gill openings wide, carried forward to below anterior margin of eye. Gill rakers moderately strong, toothed on their inner side, about 12 on lower limb.

Body and head scaled, no scales on orbital ring. All fins except ventrals more or less scaled; strong scaly sheaths at base of dorsal and anal. The scales are smooth with finely ctenoid margins, those on median portion of sides largest. Three rows of scales on opercle with a few additional small scales on lower margin. Eight scales between dorsal and head, about 14 series on top of head.

Origin of dorsal fin midway between tip of snout and base of twelfth dorsal spine, the median spines of the fin are longest, the first spine is 1.25 in eye, the eighth is 2 in head, the thirteenth is 2.10 in head. The soft dorsal is pointed, its longest ray 1.50 in head. Anal similar to soft dorsal, the second spine is 2 in head, the longest ray equal to length of head posterior of the nostril. Origin of first anal spine is under the

origin of the ninth spine of dorsal, origin of anal is much nearer origin of ventrals than to base of caudal, in fact, the distance between origin of ventrals and anal is considerably less than base of anal. Origin of ventral is midway between anal pore and a vertical line with posterior margin of iris, the ventral rays are more or less prolonged and filamentous, reaching to the origin of anal. Origin of pectorals is slightly anterior to origin of ventrals. Caudal rather long and sharp-pointed, scarcely emarginate, the upper lobe the longer, being longer than head.

Color in alcohol similar to life color except less bright being orange yellow with a slight brownish wash on top of head, fading on shoulders into the yellow body color. A blue line below eye on preopercle, some blue spots on opercle, a blue line on side of snout, a blue line from each side of belly out onto the anal fin where it forms a submarginal blue band, the tips of the anterior anal rays being black, a narrow black tip to spinous dorsal, otherwise fins all bright yellow. A black dot at origin of lateral line, another in upper axil of pectoral fin, lips dusky.

Type is No. 4737 from Sitanki Island, Jolo Archipelago. Taken by C. Canonizado and the writer 15 July, 1908. Length, 750 millimeters. Five cotypes No. 4736 were taken at the same time and place.

This species is related to *Pomacentrus popei* Evermann and Seale but the coloring is different and the relative location of the anal and ventral fins is quite different. It is also related to *P. moluccensis* Bleeker, but has larger scales and a sharp-pointed caudal, with the additional differences in color markings.

Pomacentrus elongatus Seale, sp. nov. Plate XII, fig. 2.

Head 3.50; depth 2.15; dorsal XIII, 14; anal II, 15; scales 28, 18 pores in lateral line, 14 scales in vertical series; eye 3.10 in head; snout 3.40; interorbital space 3; maxillary 3.40; mandible 3; pectoral equal to head; ventrals longer than head; depth of caudal peduncle 2.

Body oblong, compressed, rather elongate for this family. Greatest depth in middle of body. Depth of caudal peduncle a fourth greater than its length.

Anterior profile from dorsal fin to snout evenly curved and about equal to curve of thorax and chin. Interorbital space convex. Snout rounded, its median width being slightly less than its length. Orbital ring strongly toothed, unscaled, very narrow below pupil, becoming wider under anterior of eye, its width at angle of mouth 2 in eye. A rather strong spine at posterior margin of this wide portion. Preopercle denticulate. Mouth small. Maxillary ending under anterior margin of orbit. Mandible ending under anterior margin of pupil. Teeth in two series the second being smaller and less securely fixed and alternating with those of the anterior series. Gill openings large, being carried forward to below anterior margin of orbit. Gill rakers slender, about 14 on lower limb.

Scales covering entire body and head, except orbital ring and chin.

Four rows of scales on preopercle, the lower row consisting of three or four small scales. All fins, except ventrals, more or less scaled, dorsal and anal with high scaly sheath.

Origin of dorsal midway between tip of snout and base of 11th dorsal spine, the spines increasing in length posteriorly, anterior spine equal to orbit, posterior spine 1.35 in head. Soft dorsal, caudal, and anal sharp pointed, the caudal scarcely emarginate, the upper lobe the longest: Second anal spine 1.55 in head. Longest rays of anal equal to rays of soft dorsal, 1.10 in head. Origin of anal is on a line with base of 13th dorsal spine, and is but slightly nearer origin of ventrals than to end of caudal vertebra. Origin of ventrals midway between anal and angle of jaw.

Color in life brown, becoming lighter on caudal peduncle, some blue lines on cheeks and top of head.

Color in alcohol is a reddish brown, shading into yellow on caudal peduncle, the caudal yellow, with a very slight wash of dusky. Distinct blue lines of less width than pupil uniting on top of snout extend back to about origin of lateral line at top of eye. Another from anterior of eye to middle of maxillary. A few blue dots on cheeks. A black dot at origin of lateral line. Inner axil of pectorals whitish, giving a more or less distinct white dot in upper axil of fin, pectorals grayish, ventrals black, other fins similar to color of body except the yellow caudal.

Type is No. 2214, collected by the writer and C. Canonizado at Limbones Cove at the entrance to Manila Bay, Luzon, P. I., 14 January, 1908. Length, 765 millimeters. Two cotypes were taken at same time and place, Nos. 2212 and 2213.

This species is *P. trilineatus* of Bleeker, Atlas, fig. 3, which we believe to be distinct from the original *P. trilineatus* Ehrenberg.

***Pomacentrus suluensis* Seale, sp. nov.**

Head 3; depth 2.10; dorsal XIII, 13; anal II, 14; scales 25, nineteen pores in lateral line, 12 scales in vertical series; eye 3 in head; snout 3.55; interorbital space 3.20; maxillary 3; mandible 2; pectorals 1.10 in head; ventrals about equal to head; depth of caudal peduncle 1.75 in head.

Body is oblong, compressed, the greatest depth being in the middle of body; upper and lower anterior profiles from base of dorsal and base of ventrals to snout are equal low curves, making the head rather sharp pointed. Depth of caudal peduncle slightly greater than its length. The top of head is almost a straight line from dorsal to snout, the curve being very low. Interorbital space slightly convex, median width of snout slightly greater than its length; two low ridges on upper side of snout; preopercle denticulate. Orbital ring entirely smooth and unscaled, its width at angle of mouth about equal to pupil; suborbital very narrow, less than one-half of pupil. Maxillary scarcely extends to anterior margin

of eye; mandible ending under anterior margin of eye, the lower jaw slightly the longest. Teeth rather strong, in two series, the second alternating with those of first series.

Gill openings wide, carried forward to below anterior margin of orbit, gill rakers sharp-pointed, rather long, about 18 on lower limb.

Body entirely covered with ctenoid scales. All the fins except ventrals more or less scaled. Large scaly sheaths at dorsal and anal, three rows of scales on preopercle.

Origin of dorsal fin midway between tip of snout and base of last dorsal spine, the median dorsal spines are longest, being 2 in head. Longest dorsal ray about equal to longest anal ray, being 1.50 in head; dorsal, anal, and caudal sharp-pointed, caudal scarcely emarginate. Origin of anal under base of eleventh dorsal spine, being nearer origin of ventrals than to base of caudal. Origin of ventrals midway between anal and a vertical line with anterior margin of pupil. Caudal equal to length of head.

Color in life yellowish white, with two reddish brown vertical areas, one occupying the entire head, its posterior border from origin of dorsal to origin of ventrals, the second is from sixth dorsal spine to base of sixth soft dorsal ray down on sides to anterior half of anal fin. A large black yellow-edged ocellus on the last four spines, remainder of soft dorsal and caudal are yellowish white, the anal is bright yellow, some purplish on its anterior part. Ventrals white with some purplish anteriorly; no spot in axil of pectoral or at origin of lateral line.

Color in alcohol similar to above, but the purplish on anal more distinct, forming a dusky anterior border to fin.

Type is No. 4689. Secured by the writer and C. Canonizado at the Island of Sitanki, Jolo Archipelago, 12 July, 1908. Length 355 millimeters.

This species is related to *P. notaphthalmus* Bleeker but differs considerably in the color markings and in having preorbital strongly serrated, the anal fin sharp-pointed and the black spot above operculum absent.

Abudefduf coracinus Seale, sp. nov. Plate XIII.

Head 3.60; depth 2; dorsal XIII, 14; anal II, 13; scales 27; 18 pores in lateral line which ends under middle of soft dorsal, 14 scales in vertical series; eye 3.50; snout 3.10; interorbital space 2.50; maxillary 3.25; mandible 3; pectorals 1.10; ventrals longer than head, 3.15 in length, caudal peduncle 1.60 in head.

Body is oblong compressed, its depth is about the same at origin of ventrals as at origin of anal, depth of caudal peduncle is slightly greater than its length.

Head is evenly rounded. The jaws when closed are equal. The greatest width of head is 1.75 in its greatest depth, the profile both from

the origin of dorsal to snout and from origin of ventrals to snout is a low even curve. The interorbital space is slightly and evenly convex. The snout is rounded, its depth at nostril being greater than its width. Preorbital is rather wide and unscathed, the anterior margin not notched, its width at angle of jaw 1.50 in orbit, its width below middle of eye very little less than its angle. Maxillary ending on a line midway between posterior nostril and anterior margin of eye. The end of mandible not reaching to orbit. Teeth in a single series in jaws, rather strong, fixed, almost conical, and with a slight curve, 20 on each side of lower jaw. No teeth on vomer or palatine. Gill openings large, ending on a line slightly anterior to orbit. Gill rakers slender and pointed, the longest about equal to pupil, 14 on lower limb.

Scales covering entire body and head except the orbital ring, maxillary, and mandibles: the scales are large smooth with their margins finely ctenoid. Fins scaled, except the ventrals; a high scaly sheath to dorsals and anal. A large axillary scale at ventrals; scales largest on the median anterior part of body; small scales at base of fins and thorax. Six scales between origin of dorsal and head and about 13 series on top of head. Two rows of large scales on the preopercle with two or three small scales on its lower margin.

Origin of dorsal fin about the width of eye posterior to pectoral axil, the first spine being midway between tip of snout and origin of twelfth dorsal spine, the spines gradually increase in length posteriorly, the first spine being 1.30 in eye while the last 2 in head (measured to base of scaly sheath). Soft dorsal rounded, its longest ray 1.25 in head. The anal is similar in shape to soft dorsal, its second spine is 2 in head, the longest ray is about equal to longest ray of soft dorsal; origin of second anal spine on a line with base of 13th dorsal spine, being midway between end of caudal vertebra and origin of ventrals, the first anal spine is quite a little in advance of the second. Origin of ventrals midway between first anal spine and tip of snout; ventrals are slightly filamentous at tip but do not quite reach to anal pore. Pectorals are rounded, the width of their base being 2.50 in their length. Caudal rounded, scarcely emarginate, the upper lobe the longer, being about equal to length of head.

Color in life uniform dark brown or blackish.

Color in alcohol olivaceous black, fins black, opercular flap black. A black dot at axil of pectorals. No ocelli anywhere.

Type is No. 4908. A specimen 123 millimeters in length taken by the writer and C. Canonizado at Sitanki Island, Jolo Archipelago, 18 July, 1908.

This species very closely resembles *A. malas* but is easily distinguished by the naked orbital ring

Family LABRIDÆ.

Halichoeres iris Seale, sp. nov.

Head 3.10 (measured to end of opercular flap); depth 3; dorsal IX, 13; anal II, 11; scales 26; $13\frac{1}{2}$ in vertical series; eye 4.50 in head; snout 2.75; interorbital 4.10; maxillary 4.50; mandible 3.

Body oblong, compressed, the upper and lower outlines evenly curved to the rather pointed head and snout. Depth of caudal peduncle 2.1 in head, its length 3 in head. Mouth rather small, the jaws equal, the upper jaw protractile, upper lip with wide fold, lower lip with fold less developed. Teeth in a single series in each jaw, the anterior ones consisting of enlarged projecting canines; they graduate in size posteriorly. No canines at angle of jaws. No teeth on vomer or palatines. Gill openings extend forward to line with angle of preopercle. Gill rakers small, fine-pointed, about 13 on lower limb.

Body covered with large smooth scales, which are much smaller on thorax. Head entirely naked, fins unscaled, except a row at base of dorsal and anal, and basal half of caudal. Lateral line continuous.

The dorsal spines are short and pungent, the origin of the fin is midway between tip of snout and base of sixth dorsal ray, the longest spine about 4.25 in head, the longest ray 3. Caudal is slightly lunate, its length 1.35 in head. Origin of anal midway between the end of last caudal vertebra and the posterior margin of hard opercle, being on a line with the base of third dorsal ray, its base is 1.20 in head, its second spine is longest, 3.25 in head, its longest ray 2.50. Origin of ventrals slightly nearer angle of mouth than to anal, the length 2.10 in head. Pectorals 1.30 in head, ending on a line with ninth scale of lateral line.

Color in life. The general color is greenish above and bluish below; there are seven purplish bands over back which extend obliquely back and down to about the median line of sides, the anterior band is from nuchal region to axil of pectoral, the second from origin of dorsal, third from posterior portion of spinous dorsal, fourth from anterior portion of soft dorsal, fifth from middle of soft dorsal, sixth from posterior portion of soft dorsal and the seventh over the middle of caudal peduncle; these bands are almost as wide as the interspaces. The top of head and nuchal region are purple, there are three wide rosy bands tinted with purplish on sides of head, one from posterior of eye to posterior margin of opercle near base of pectoral, one from lower portion of orbit to lower posterior margin of opercles, one from lower anterior margin of orbit to behind angle of mouth; these bars are of slightly greater width than pupil, the coloring of cheeks between these bars is yellowish, with portions shading into orange and greenish, the lower jaw and throat blue, base of pectorals purplish, the base of rays yellow. Spinous dorsal purplish with deep green on base, the purplish coloring extending back as a

graduating line through the lower half of soft dorsal, general color of soft dorsal, pale yellowish, caudal yellowish with tint of green, the upper and lower rays green with the second ray a heavy brownish red. Anal pale yellowish, ventrals pinkish, pectorals washed with yellowish at base and slightly dusky at tip.

Color in alcohol similar to above, except the bluish below fades into whitish, the deep green on dorsal and between the purple bars fades and becomes dull bluish, the stripes on head brown-purplish, the anal shows a dusky blotch on middle of anterior rays.

Type is No. 4582 from Sitanki Island, Jolo Archipelago, P. I., 2 July, 1908. Length, 112 millimeters.

Choerops palawanensis Seale, sp. nov.

Head 3; depth 2.80; dorsal XIV, 7; anal III, 10; scales 28; 11 scales in vertical series; eye 6; snout 2.35; interorbital 5.50; cheeks with about 6 rows of imbricate scales.

Body oblong, compressed, the upper outline more rounded than lower. Depth of caudal peduncle 2.35 in head.

Upper profile of head a strong even curve back to origin of dorsal. Interorbital space convex. Greatest depth of head 1.14 in its length; mouth rather large, the upper jaw protractile. Lips thick, with fold, four strong projecting canines in the front of each jaw, a canine at angle of upper jaw. Posterior margin of preopercle is finely denticulate. Lower limb of preopercle naked. Gill openings moderate, ending on a line slightly posterior to eye. Gill rakers thick, sharp-pointed, short, about 8 on lower limb.

The scales are large and smooth, fully covering head and body except top of head, snout, limb of preopercle, and chin. Tubules of lateral line strongly branched.

Origin of dorsal midway between tip of snout and base of 12th dorsal spine, the longest spine 3.50 in head, its posterior rays the longest, 2.50 in head. Base of anal 1.15 in head, its posterior ray 2.20, origin of anal is midway between last caudal vertebra and angle of preopercle. Origin of ventrals midway between anal and angle of mouth, the anterior rays elongate, reaching to base of anal. Pectorals 1.25, ending on a line with 12th scale of lateral line. Caudal slightly hunate, 1.15 in head.

Color in life. General color brownish above, whitish below, margins of the scales drab. An oblong bright yellow patch on sides under posterior third of spinous dorsal, a row of about five black spots along the median line, sides of head greenish with tint of yellow, the color below this is blue, a red line back from angle of mouth marks the meeting of these two colors, four greenish lines on sides of snout from eye to mouth, about 6 oblique yellow lines on opercle, three red lines on lower jaw, two rows of dusky dots near base of dorsal fin. Dorsal blue with about 4 irregular rows of red dots tending to form broken vertical lines on

soft dorsal. Margin of spinous dorsal blue. Anal similar to dorsal in color except that the round red spots tend to form two or three longitudinal lines on distal portion of fin. Caudal yellowish green with alternating blue and red dots on sides. Ventrals blue, the webs yellow. Pectorals yellow, blue at base with a ring of red.

Color in alcohol dull light brown with tint of green, the golden blotch and the black dots on sides show distinctly. Markings of dorsal scarcely showing; markings of anal more distinct, the dots being yellow, caudal almost uniform greenish with the slightest trace of markings.

Type is No. 5501, from Puerto Princessa, Palawan Island, P. I., 22 August, 1907. Length, 235 millimeters.

Family SCARICHTHYIDÆ.

Callyodon rostratus Seale, sp. nov. (Ogos.)

Head 2.75, measured from tip of opercular flap to tip of upper teeth; depth 3; dorsal IX, 10; anal III, 9; scales 23; $8\frac{1}{2}$ scales in vertical series; eye 7 in head; snout 2.20; interorbital 3.15, two rows of scales on cheeks, the lower limb of preopercle being entirely naked; only the slightest indication of canine teeth at angle of upper jaw, none on lower; teeth green, the margins crenulate; lips narrow, not covering half of either jaw.

Body oblong compressed, the upper and lower outlines equal, the snout is heavy and deep, the teeth large and exposed, giving a blunt appearance to the head. Depth of caudal peduncle 2.50 in head.

Depth of head 1.40 in its length, the upper and lower outlines with very low angle. Interorbital space convex. Gill openings are carried forward to below eye. Gill rakers numerous, minute and hair-like. Scales large and smooth, $3\frac{1}{2}$ in front of dorsal. Origin of dorsal midway between tip of teeth and second dorsal ray, its longest spine 3 in head, the last ray 3.25. Caudal slightly rounded in middle, the lower ray slightly produced. Base of anal 1.70 in head, its origin being midway between last caudal vertebra and axil of pectoral, its longest ray 3. Origin of ventrals slightly nearer to angle of jaws than to anal, their length 2.10 in head. Pectorals 1.50 in head.

Color in life deep blue-green, more decidedly bluish on belly, which shows three or four longitudinal stripes of darker blue. A yellowish area encircles and occupies the entire caudal peduncle. Cheeks washed with reddish, two darker lines extend back from eye. A red line around lips, a second red line across base of lower jaw. Dorsal red with a green line through center and a deep blue margin. Caudal deep blue, with some of the webs washed with red. Base of anal red, the distal two-thirds blue. Pectorals green, the first ray blue. Teeth green.

Color in alcohol yellowish shaded with dull brownish. A yellow area occupies caudal peduncle, two wide dusky stripes from posterior part of eye, snout greenish. Cheeks and opercles yellowish except the upper portion of opercle which is crossed by the dusky bar. An indistinct line

from below angle of jaws around lower lip, dorsal grayish with yellowish margin and clouded with dusky in center. Caudal yellowish with some lighter markings on webs. Anal whitish at base, the distal two-thirds yellowish. Ventrals yellowish, pectorals yellowish, teeth green.

Type No. 2928 from Zamboanga, Mindanao, P. I., 10 April, 1908. Length, 215 millimeters.

*Callyodon hadji*⁷ Seale, sp. nov.

Head 3; depth 2.45; dorsal IX, 9; anal III, 9; scales 24 to end of caudal vertebra, $8\frac{1}{2}$ scales in vertical series; eye 5.75 in head; snout 2.60; interorbital space about equal to snout; scales on cheeks in three rows, the lower row covering the limb of preopercle; lips rather wide covering about two-thirds of jaws: each jaw with a strong canine near angle; teeth rosy; pectorals 1.30 in head; ventrals 1.75.

Body oblong, compressed, the upper and lower outlines about evenly curved, the head moderately pointed; least depth of caudal peduncle 2.1 in head, being about equal to its length.

Greatest depth of head about equal to its length. Interorbital space convex. Snout not particularly blunt. Lips thin, without folds. Gill openings of moderate size, ending anteriorly on a line with posterior margin of eye. Gill rakers very minute, short, hair-like, at least 22 on lower limb. Pseudobranchia large.

Scales large and smooth. Body and head fully scaled except snout and chin. Six scales in front of dorsal. Origin of dorsal is midway between tip of snout and base of second dorsal ray, its longest spine 2.75 in head, its longest ray 2.75 in head. Base of anal 1.20 in head, its origin midway between end of caudal vertebra and angle of preopercle, its longest ray about 3 in head, origin of ventrals midway between anal and angle of jaws, the fin not reaching to anal pore. Origin of pectorals below origin of dorsal, its tip on a line with ninth scale of lateral line. Caudal slightly lunate, its longest rays equal to pectoral, the mid rays 1.50 in head.

Color in life is chiefly pinkish and bluish green. The throat, thorax, belly and sides below the median line being a bright pink; each scale on entire side in front of caudal peduncle is margined with pink, upper part of sides and back green, upper half of head reddish brown, caudal peduncle blue-green, upper lip bright green with a blue-green line around its base, this line is bordered by pink above and extends to below and slightly posterior to eye. Three short blue-green lines radiate from eye, two backward and one forward. An irregular-shaped bright green area extends from angle of mouth to below eye and down almost to chin. Under lip pink crossed by two deep blue lines, one near margin the other near base of lip. About 8 deep blue spots or dashes on each side of throat. A row of deeper green spots along base of dorsal fin. Dorsal

⁷ Hadji=Moro pilgrim or chief.

fin salmon-red with a broad blue-green border. A row of green spots along middle of red portion. Caudal fin pea-green with deep blue upper and lower margin. Anal fin deep red with outer half blue. Pectorals deep blue with 4th to 5th rays bright pink. Ventrals pinkish and yellow with anterior ray blue-green.

Color in spirits uniform dull grayish, whitish on belly, the bright greenish irregular area back of angle of mouth shows distinctly. All markings of the fins dull but show the general arrangement described above, the pectorals are greenish with a darker stripe on second to fourth rays.

Type is No. 5367 from Puerto Princesa, Palawan, 19 August, 1909. Length, 235 millimeters, and cotype 5494 from same locality.

***Callyodon albipunctatus* Seale, sp. nov.**

Head 2.75; depth 3; dorsal IX, 10; anal III, 9; scales 23, $8\frac{1}{2}$ in vertical series; eye 5.25; snout 2.50; interorbital 3.25; two rows of scales on cheeks; lower limb of preopercle entirely naked; lips narrow, the teeth being more than half exposed; teeth pinkish.

Body oblong compressed, under normal conditions the upper and lower outlines are evenly curved; the snout, however, is very deep, giving a blunt appearance to head. Depth of caudal peduncle 2.75 in head. Greatest depth of head 1.35 in its length. Mouth rather large. Teeth prominent, no canines. Gill openings carried forward to a line with posterior third of eye. Gill rakers numerous, minute and hair-like. Pseudobranchia large.

Scales large and smooth, four in front of dorsal. Body and head fully scaled except on interorbital space and snout, preopercular limb and chin.

Origin of dorsal midway between tip of teeth and second dorsal ray, the longest spine 3.10 in head, the longest ray 3.10. Origin of anal midway between axil of pectoral and last caudal vertebra, its base 1.75 in head, its longest ray 3.10. Origin of ventrals midway between angle of jaw and anal, their length 2.10 in head. Pectorals 1.50, caudal truncate.

Color in life. General color of lower parts pinkish, the scales on upper portion of body with greenish bases and margins. About ten distinct round white spots on sides usually in pairs at regular intervals, belly with slight wash of purplish. Dorsal fin uniform pink. Caudal uniform pink. Anal bluish at base, fading to pink distally. Pectorals and ventrals uniform pink, iris golden, snout and chin uniform pink, cheeks with a slight tint of bluish. A wide yellow area surrounding caudal peduncle.

Color in alcohol grayish, base of scales darker, belly purplish, gape and chin and area at base of caudal yellowish. Twelve to fourteen round white spots on posterior half of body, fins uniform grayish green.

Type is No. 4876 from Sitanki Island, Jolo Archipelago, P. I., 18, July, 1908. Length, 170 millimeters.

Callyodon ogos Seale, sp. nov.

Head 3.20; depth 2.70; dorsal IX, 10; anal III, 9; scales 22, 8½ in vertical series; eye 5.50 in head; snout 2.85; interorbital 3.15; two rows of scales on cheeks; the lower limb of preopercle naked; lips wide; a canine tooth at angle of each jaw.

Body oblong compressed, the upper and lower outlines evenly curved; head rather more pointed than is usual in this genus. Depth of caudal peduncle somewhat greater than its length, being 2 in head.

Greatest depth of head 1.14 in its length. Interorbital space convex. The lips are wide, the upper almost wholly covering the teeth, the lower covering more than two-thirds of lower teeth. The teeth in life were rosy. The canine teeth of the lower jaw are largest, those of the upper jaw being rather blunt. Gill rakers fine almost hair-like, short, about 26 on lower limb. Gill openings of moderate width, ending on a line with posterior margin of eye. Pseudobranchia large.

Scales are large and smooth, body and head are fully scaled except interorbital space, snout, lower limb of preopercle and chin, which are naked. Lips thin, without folds.

Origin of dorsal midway between tip of snout and base of first dorsal ray, longest spine 2.25 in head, about equal to longest ray. Base of anal 1.20 in head, the origin of the fin is considerably nearer the end of caudal vertebra than to angle of preopercle, its posterior ray 2.50 in head. Origin of ventrals considerably posterior to origin of pectorals, being midway between anal and angle of mouth, their length 1.50 in head. Pectorals 1.25 in head, their tip on a line with 8th scale of lateral line. Caudal is slightly lunate.

Color in life chiefly blue-green; however, there is a large area occupying the upper and median portion of the sides which is reddish yellow, the margins of the scales in this area are green. The upper anterior portion of back is deep green, the lower portion of sides, belly, and caudal peduncle is deep blue-green. About twelve short red lines radiate from eye. A large wedge-shaped deep green area with red margins extends from posterior margin of eye to posterior margin of opercles, ending just in front of axil of pectorals. Snout deep green. A red line from eye to angle of jaws. Lower lip rosy with blue margin and crossed by blue line at base. Two short longitudinal blue lines on sides of throat, base of pectorals rosy with a deep green line across base of rays. Dorsal rosy at base and broadly margined with deep blue, the median portion of the fin between these colors being bright red above and deep green below, the green color fading out and changing into a bright yellow on posterior portion of soft dorsal. Caudal with upper and lower rays bright blue, the second and third upper and lower rays bright pink, the remainder of fin rather dark blue. Anal blue-green, the margin and base darker blue, the median portion with tint of pinkish, showing some darker greenish blotches between the rays. Ventrals with rays deep blue-

green except second rays which are bright pink. Pectorals uniform red, a green line across base.

Color in alcohol. The above striking colors almost entirely disappear and the fish becomes a dull yellowish brown, the fins show very indistinctly the markings described above, the blue of the margins fading into a yellowish white; the deep green wedge-shaped area between eye and axil of pectorals becomes a yellowish area of no distinct shape, while the lines which radiate from eye almost entirely disappear. The pectoral becomes yellowish white with a dusky dot on its upper axil.

Type is No. 5414 from Puerto Princesa, Palawan Island, 20 August, 1908. Length, 225 millimeters, and cotype No. 5411 from the same locality.

Family PSEUDOCROMIDÆ.

Pseudochromis aurea Seale, sp. nov.

Head 3.40; depth 3; dorsal III, 26; anal III, 14; scales 41, vertical series 14; eye 4; snout 3.75; interorbital 5; maxillary 2.50, its distal end on a line with pupil; mandible 1.90.

Body oblong, compressed, the upper anterior outline from origin of dorsal to tip of snout is a low even curve, the lower outline comparatively straight. Depth of caudal peduncle 1.85 in head, its length one-half its depth. Mouth of moderate size, the lower jaw projecting. Teeth in front of jaws in several series with about 4 large curved canines, teeth on sides of jaws in single series, teeth on vomer and palatines. Cheeks with 4 rows of scales, opercle with a single flat obtuse spine and covered with large scales. Gill openings carried forward slightly past angle of preopercle. Gill rakers rather flat and wide, about 13 on lower limb. Three membranous points to lower limb of preopercle. Pseudobranchia present.

Entire body covered with fine smooth scales which have a finely denticulate border.

Origin of dorsal midway between tip of snout and base of 11th ray of soft dorsal, the spines rather weak, the longest 3 in head, the longest ray 1.30 in head; caudal rounded, its length equal to head. Origin of anal about midway between end of caudal vertebra and posterior margin of opercles, the length of its base equal to head, its third spine the longest, 2.30 in head, its longest ray 1.50 in head. Origin of ventrals but slightly nearer anal than to tip of snout, the rays elongate reaching to base of anal. Pectorals 1.14 in head.

Color in life bright orange, most of the scales below the lateral line, except on thorax, have a bright blue dot. Two blue lines cross the eye-ball but do not extend out of orbit, head uniform yellow orange, very slightly dark above, fins all uniform orange without markings.

Color in alcohol uniform yellow, most of scales showing indication of a dot on each scale, blue lateral line except on thorax and head; fins yellow, some indistinct indications of dots on anal.

Type is No. 4899 from Sitanki Island, Jolo Archipelago, P. I., 18 July, 1908. Length, 90 millimeters. Numerous cotypes.

Pseudochromis rex Seale, sp. nov.

Head 3.50; depth 2.90; dorsal III, 25; anal III, 14; pores in lateral line 44, 16 scales in vertical series; eye 4.50 in head; snout 3.20; interorbital 4.20; maxillary 2.50, its distal end under anterior margin of eye; mandible 1.90; width of preorbital 1.75 in orbit.

Body oblong, compressed. Upper anterior profile from origin of dorsal to tip of snout, a moderate and even curve. Depth of caudal peduncle 1.55 in head, its length about one-half its depth. Mouth of moderate size. Lower jaw slightly projecting. Teeth in anterior of jaws in several rows with several large curved canines, those in side of jaws in single row, conical, sharp-pointed. Teeth on vomer and palatines. Cheeks with five rows of scales. Preorbital with two or three membranous points; opercles with a single flat spine. Gill openings rather narrow, scarcely extending forward to angle of preopercle. Gill rakers short and thick, with asperites on inner surface, 12 on lower limb. Pseudobranchia present. Entire body and head, except snout and chin, covered with fine smooth scales; scales on opercles largest; fins, except caudal, unscald. Origin of dorsal midway between tip of snout and 10th ray of soft dorsal, the dorsal spines very thick and stiff, the third the longest, equal to length of snout, the first dorsal ray considerably longer, 1.75 in head. Base of anal almost equal to length of head, its origin midway between end of caudal vertebra and posterior margin of opercle, its longest ray 2 in head. Ventrals 1.40 in head, their spine 2, their origin is midway between anal and gape of mouth. Pectorals 1.20 in head. Caudal rounded in young, but with upper and lower rays slightly produced in old specimens, length of caudal 1.12 in head.

Color in life. Upper anterior portion of head and body dark bluish with a jet black line equal to width of pupil from tip of snout through eye to below the anterior third of soft dorsal, some dusky dots below the posterior half of this line, general color of body yellow, belly and chin pale blue, dorsal dusky on base with bluish wash, the outer two-thirds of fin yellowish white posteriorly, caudal and anal uniform yellow, ventrals bluish white, pectorals yellowish.

Color in alcohol. Upper anterior portion of body and head brownish with some fine black specks. A black line from snout through eye, extending back and becoming more diffused, fading out under posterior third of soft dorsal. Other portions of body yellowish white without markings, dorsal dusky at base, lighter on its distal half, other fins uniform yellowish white.

Numerous specimens. Type is No. 4631 from Sitanki Island, Jolo Archipelago, P. I., 4 July, 1908. Length, 120 millimeters.

Labracinus flavipinnis Seale, sp. nov.

Head 3.50; depth 3.75; dorsal II, 20; anal III, 10; scales 36, lateral line interrupted; vertical series $10\frac{1}{2}$; eye 3.10; snout 4.75; interorbital equal to snout; maxillary 3.75, its distal end under anterior margin of pupil.

Upper and lower outlines of body evenly and equally curved, depth of caudal peduncle 1.75 in head, its length 2 in head. Head moderately pointed. The lower jaw slightly longer. Mouth oblique, small. Teeth of upper jaw fine, in several bands, with about 6 enlarged anterior canines. Teeth of lower jaw in a single series on sides with two enlarged canines and bands of small teeth in front. Teeth on vomer and palatine. Scales on cheeks in three rows; opercular and preopercular margins entire. Gill openings wide, being carried forward to a line with posterior margin of orbit. Gill rakers thin, sharp-pointed, short, about 12 on lower limb.

Body and head, except snout and chin, covered with rather small smooth scales, caudal scaled for half its length, other fins unscaled, about ten rows of scales in front of dorsal. The two dorsal spines short, the second being about half length of first ray, the longest ray about 2.10 in head. The caudal is rounded, 1.30 in head. Origin of anal midway between end of last caudal vertebra and a line with middle of opercle, its rays about 2 in head. Origin of ventrals slightly in front of origin of pectorals, being considerably nearer the tip of snout than to anal, its length 1.14 in head. Pectorals 1.25.

Color in life yellowish brown, darkest anteriorly, the posterior half of body with some small vertical blue marks. Top of snout, interorbital space and nuchal region back along base of spinous dorsal black. Lower half of spinous dorsal jet black, the upper half orange, a narrow yellow line between the colors. Caudal yellow, a jet black line extends from along top of caudal peduncle into the fin where it forms a submarginal wedge-shaped band; anal and ventrals pink; pectorals yellowish brown.

Color in alcohol similar to above but less bright, the bluish markings obsolete.

Type is No. 4410 from Zamboanga, Mindanao, P. I., 11 June, 1908. Length, 46 millimeters.

Family OSPHROMENIDÆ.

Osphromenus insulatus Seale, sp. nov.

Head 3.18; depth 2.75; dorsal VII, 8; anal XI, 32; scales about 45 in lateral series, from 20 to 34 pores in lateral line which is very irregular, in the type specimen the line is broken on one side and jumps 4 scales, in some cotypes the line is broken in two or three places and jumps several scales, in the type the lateral line has a distinct arch anteriorly as in the carangoids, becoming more or less straight about the middle

of fish; ventrals 5, the first ray filiform, extending to caudal, the other rays very small, almost atrophied. Maxillary short, slightly less than diameter of eye; interorbital space 2.50 in head.

Body oblong, compressed, the head is pointed, the profile from nuchal region to tip of snout is very slightly concave. Depth of caudal peduncle 2.35 in head.

The interorbital space is slightly convex, the mouth is small and directed upward, the lower jaw strongly projecting; width of preorbital is two-thirds of eye, it has a strong notch which receives the tip of the maxillary, lower margins of preorbital provided with about 8 distinct teeth. Jaws with bands of small sharp teeth including several enlarged canines, the latter being curved and more or less projecting; no teeth on vomer or palatine. The posterior margin of preopercle is entire, but its lower limb is margined by a row of long sharp teeth. Opercle without spine, ending in a sharp membranous flap. Three rows of scales on opercles and four on cheeks. Gill openings united on isthmus. Gill rakers numerous, short, flat, sharp-pointed.

Entire body including head covered with fine ctenoid scales, scales largest on opercles, soft dorsal with large scales on base, caudal and anal scaled, throat scaled.

Origin of dorsal is midway between pupil and end of last vertebra, the spines graduate in size, the last one the longest, about 2.1, the rays in male specimens elongate, greater than length of head, caudal slightly inclined to be bilobed, its length slightly greater than head. Spinous anal fitting into a scaly sheath, origin of its first spine midway between tip of upper jaw and ninth anal ray, the spinous portion contained about twice in soft posterior portion, the longest spine about 3 in head, the longest ray 1.35. Origin of ventrals in advance of pectorals, their anterior ray reaching to, or almost to, base of caudal. Pectorals about equal to length of head.

Color in life brown with some irregular blackish marks on shoulders, some yellowish on opercles and on thorax, some vivid pink at base of anal, extending almost length of base. Dorsal, yellowish brown in females, brown in males, the rays marked with yellowish dark-ringed spots. Caudal brown with numerous yellowish spots, anal brown with some yellowish spots, pectorals brown, ventrals yellowish, a distinct black spot at base of caudal, another on middle of side.

Color in alcohol similar to above but yellow much faded, and the pink at base of anal disappears.

Type is No. 4951 from lake on Cagayan-Sulu Island, Sulu Sea. Length, 73 millimeters. Numerous cotypes.

It is rather interesting to find this form in a crater lake on this volcanic island, isolated as it is in the Sulu Sea.

Family GOBIIDÆ.

Genus **BIAT** Seale, new genus.⁸

This genus is related to *Oxyurichthys* Bleeker but differs in being without nuchal crest or tentacle and in having the upper teeth in two or more series. From *Gobionellus* Girard it differs in having the teeth firm instead of movable. From *Gobiichthys* Klunzanger it differs in having no tentacle over eye and in other respects. It is characterized by the smooth head, without scales, tentacles, or crest, the extremely elongate fully united ventrals, the fine ctenoid scales which are larger posteriorly and the many rayed (16-17) dorsal and anal

Type is *Biat luzonica* Seale, No. 2040 in collection of Bureau of Science, Manila, from east coast of Luzon Island. Length, 190 millimeters.

Biat luzonica Seale, sp. nov.

Head 4.10; depth 5.10; dorsal VI, 16; anal 17, scales about 110 in a median line; about 25 in lateral series; head entirely naked; eye 4.75 in head; snout 4; eyes close together, the interorbital space less than width of pupil; maxillary 2.45 in head; mandible 2.10.

Body elongate, cylindrical, its greatest width 1.50 in its depth. Depth of caudal peduncle 2.30. Head rather blunt, the anterior profile of head from eye to tip of snout has an angle of about 45 degrees. The mouth is slightly oblique, the lower jaw a little the longer. Gill openings rather wide, being carried forward to a line with angle of preopercle. Gill rakers short and blunt, 10 on lower limb. Margins of opercle and preopercle smooth. The teeth of each jaw are in several series with the addition of an irregular row of short curved canines, the anterior ones being enlarged. Tongue is rounded and adnate to floor of mouth for its entire length. No teeth on vomer or palatine. No barbules or tentacles. Lips with fold of skin, no lines of cirri, or prominent mucous pores, except one with a bifurcated opening on back part of interorbital space.

The entire body is covered with fine ctenoid scales which become larger posteriorly. About 25 series of scales in front of dorsal which, however, do not encroach upon the head.

Spinous dorsal of 6 thin flexible spines which tend to become filamentous, the longest about 1.50 in head, the origin of spinous dorsal is midway between tip of snout and base of third soft ray. Longest ray of soft dorsal 1.45 in head. Origin of anal midway between end of caudal vertebra and angle of preopercle, its base 3.10 in length of fish without caudal, its longest ray 1.50 in head. Caudal lanceolate in shape, its length almost a fourth greater than head. Origin of ventrals midway between anal and angle of mouth, the fin united its entire length, and with a deep membranous cup which has a smooth margin, the fin very

⁸ Biat=Philippine name for goby.

long extending to base of anal, its length greater than head being almost equal to caudal. Pectorals 1.14 in head, their bases rather thick but not nearly so strongly developed as in *Periophthalmus*.

Color in alcohol (the specimen was not seen by us in a fresh state) yellowish brown with six wide dark bluish bars over back and sides, the first occupying anterior part of head including the snout and eyes. Second on nuchal region down to opercles. Third from median portion of spinous dorsal. Fourth from anterior third of soft dorsal. Fifth from posterior part of soft dorsal. Sixth on base of caudal fin. These bands are but little narrower than the interspaces and the margins are not sharply defined although the bands themselves are quite distinct. A few small yellowish spots probably red or blue in life on upper portion of head behind eye. Spinous dorsal grayish with dusky center, soft dorsal dull yellowish as is also the caudal. Anal yellowish, darker at tip with two or three narrow submarginal lines. Ventrals dark gray. Pectorals yellowish.

Type is No. 2040, from the east coast of Luzon, P. I., June, 1907. Secured by Mr. W. D. Carpenter. Length, 190 millimeters.

MACGREGORELLA,⁹ new genus.

This genus is characterized by the presence of numerous striking ridges and pockets of membrane with fringed margins on various portions of the head. The head otherwise entirely naked. No scales in front of dorsal. No pectoral filaments, no barbules, although the folds of membranes from a side view give the appearance of barbules in the figure. Body finely scaled, teeth in bands in each jaw, no large canines, tongue rounded, free at tip. Soft dorsal and anal of 9 to 12 rays. The rays or spines not elongate. Type of genus is *Macgregorella moroana* Seale from Jolo, No. 3575 in fish collection of Bureau of Science.

Macgregorella moroana. Seale, sp. nov.

Head 3.60; depth 5.50; dorsal VI, 11; anal 9; scales about 46, 16 in vertical series; eye 5 in head; snout 3; interorbital, a mere ridge about equal to pupil; maxillary 3.20, its tip not reaching to margin of eye; mandible 2.50; head and nuchal region without scales. The head is curiously marked by numerous membranes with fringed margins, the three large vertical ones on the cheeks being somewhat pocket-like. There are about twelve of these membranous cross-ridges between the tip and the angle of the preopercle, with two wide longitudinal membranes on the median line of lower jaw, preorbital and snout each with two or more membranous ridges, longitudinal as well as vertical membranous ridges on cheeks. Lips with folds, mouth small, bands of small teeth in each jaw, the outer series in upper jaw slightly enlarged, no decidedly

⁹ Named for Richard Crittenden McGregor in recognition of his noteworthy work in Philippine zoölogy.

enlarged canines; the orbital ridges are not prominently developed nor roughened. No filiform rays to pectorals, no barbules. Gill openings confined to sides. The origin of dorsal is midway between tip of snout and seventh dorsal ray, none of the spines elongate, the longest about 1.50 in head, longest dorsal ray 1.40 in head. Caudal acuminate, about one-third longer than head, longest anal ray 1.30 in head, pectorals almost equal to length of head.

Color in life yellowish white, marbled and mottled with brown and grayish. Three irregular-shaped oblique dusky bands backward and downward, one from spinous dorsal, two from soft dorsal; some dusky stripes on sides of head, one from snout to eye, another from eye to upper margin of opercle, another from posterior margin of eye obliquely backward, two others on lower sides of cheeks. Dorsal yellowish with dusky blotch in lower central portion and some other slight shadings of dusky scattered over the fin. Soft dorsal with about three oblique dusky bars, the middle one most distinct, posterior tip of fin dusky. Caudal yellowish gray with three dark bands triangular in shape, the angle pointing backward. Anal yellow with three dusky oblique bars, posterior tip of fin dusky. Ventrals pinkish with slight blotches of dusky. Pectorals yellowish, a dusky irregular bar running out on upper half of fin.

Color in alcohol. Similar to above but with the brown markings showing more distinctly, there being a dusky bar on sides of belly and another at origin of anal. A brown bar across nuchal region, a distinct brown bar obliquely downward and backward from eye, another in front of eye, and three on lower part of cheeks, fins colored as in life.

Type is No. 3575 from Jolo, Jolo Island, P. I. Length, 54 millimeters.

***Rhinogobius perpusillus* Seale, sp. nov.**

Head 3.85; depth 4; dorsal VI, 14; anal 14; scales 56, about 20 in vertical series; eye 3.85; snout 4; interorbital about equal to snout; maxillary 2.75 in head, its tip under anterior margin of pupil; mandible 2.30. Head naked except about 3 rows of scales on upper third of opercle, nuchal region finely scaled. No filamentous pectoral rays.

Body somewhat oblong and compressed, the upper and lower outlines about equally curved, the depth of caudal peduncle 2 in head. The head is rather bluntly pointed, the median width of snout being about equal to its median depth. The mouth is oblique, the lower jaw slightly longer. The tongue is rounded and adnate to floor of mouth. Teeth in upper jaw in two rows those of the outer row enlarged, curved, those of lower jaw in two rows rather large, curved, the outer ones projecting; an enlarged, recurved canine on side of jaw, no teeth on vomer or palatine. Gill openings small, restricted to sides. Body and nuchal region covered with fine scales which are slightly roughened at their margins. Origin of dorsal is midway between tip of snout and base of fourth dorsal ray, its spines not elongate, the longest ? in head, longest dorsal ray 1.50.

Origin of anal about midway between base of anal rays and angle of preopercle, its rays not elongate. Origin of ventrals much nearer tip of snout than to anal, being directly below the origin of pectorals, their length 1.20. Pectorals about equal to head, caudal slightly rounded, about equal to length of head.

Color in life a distinct whitish with a slight wash of yellow, with 3 very dark brown stripes on each side, the first from between interorbitals to and along base of dorsals, the second from tip of snout to caudal, running along the top of caudal peduncle; the third a wide heavy band from around lower lip across cheek and upper base of pectoral to middle of caudal where it ends in a black spot on the middle of caudal base, on the rays; lower half of body uniform whitish unmarked, dorsal whitish crossed by a dark band on upper third, soft dorsal grayish, darker on posterior half and with dark bar near top of fin. Caudal yellowish with dark brown line extending out on upper and lower margins. Anal yellowish at base, becoming dark on outer half; ventrals yellowish with slight grayish shading. Pectorals yellow.

Color in alcohol is similar to above but is less bright. In two specimens Nos. 1276 and 5106 the side bands are almost obliterated or small, except the wide heavy band from lower jaw, and the black spot on caudal, these specimens also show very indistinct indications of about 5 grayish cross-bands over back, they may be a distinct form.

Type is No. 4022 from Zamboanga, Mindanao. Length, 45 millimeters.

Rhinogobius carpenteri Seale, sp. nov.

Head 3; depth 6; dorsal VI, 9; anal 9; scales about 38, $8\frac{1}{2}$ in vertical series, a few scales directly in front of dorsal, otherwise the entire nuchal region and head naked; eye 5; snout 2.80; interorbital about equal to pupil; maxillary 2.55; mandible 2.10.

The upper and lower outlines are but little curved; the head is bluntly pointed, the depth of caudal peduncle is about 3, its length 1.50 in head, greatest width is at head which is 1.50 in its length, its depth being 2.25. Jaws even, mouth small, tongue almost square at tip. Jaws with several rows of teeth, the outer of which are sharply curved, canine-like. No teeth on vomer or palatines, cheeks fat. Gill openings restricted to sides. Gill rakers short, flat, about 7 on lower limb.

Origin of dorsal posterior to ventral, its longest spine 1.85 in head, the longest dorsal ray 2 in head. Origin of anal nearer to base of caudal than to origin of ventrals, being under the base of fourth dorsal ray, the longest ray 2.50 in head. Ventrals very short and disk-like, length 1.75 in head, their origin much nearer tip of snout than to anal. Caudal rounded, its length 1.30 in head. Pectorals 1.30 in head.

Body covered with small smooth scales with very fine ctenoid edges, no scales on nuchal region or head.

Color in life dull yellow-brown, uniform whitish on under jaw, eyes

blue, fins grayish, 2 anterior spines silvery white, rays of anal silvery white, caudal washed with dusky at tip.

Color in alcohol similar but less bright. Numerous specimens. Type is No. 914.

All specimens and type from the Trinidad River, Bagnio; elevation, 1,500 meters; Lauzon, P. I.

Pleurogobius boulengeri Seale, sp. nov.

Head 3; depth 3.75; dorsal VI. 12; anal 10; scales about 30, 9 in vertical series; eye 3 in head; snout 4.50; interorbital a mere ridge, being less than pupil; maxillary about equal to eye, ending on a line with margin of eye; mandible 1.85 in head; head naked except a few scales on upper edge of opercle and on nuchal region.

Upper outline of body more curved than lower, the greatest depth at origin of dorsal, the greatest width being at opercles where it is 1.35 in head. Head rather blunt, the lower jaw projecting, the mouth being somewhat oblique. Depth of caudal peduncle 2.50 in head.

Head without barbules or cross-lines of cirri on cheeks, median portion of snout, however, somewhat roughened by two prominent lines of mucous pores. Mouth rather large, tongue free, sub-truncate at tip. Teeth in several rows in each jaw, the outer row enlarged, curved, canine-like, but without prominent recurved canine on sides of lower jaw. Gill openings restricted to sides.

Body fully covered with fine smooth scales which cover nuchal region and extend slightly on upper margin of opercles, otherwise head entirely naked.

Origin of dorsal midway between tip of snout and base of fifth dorsal ray, the spines fine, not elongate, their longest 2.25 in head. Longest soft dorsal ray 1.75 in head; caudal rounded 1.25 in head. Origin of anal is midway between end of caudal vertebra and the angle of the preopercle, its longest ray 1.85 in head; origin of ventrals nearer tip of snout than to anal pore, their length 1.10 in head. Pectorals scarcely equal to head.

Color dark brown banded by 12 narrow white, dark-margined vertical bands which completely encircle the body and are of much less width than the interspaces, four of these bands are on the head, the first over the snout just in front of eyes and down to angle of mouth, the second from outer part of nuchal region down through eyes, the third and fourth from nuchal region down sides of head, the fifth from origin of dorsal over base of pectorals, the remainder at regular intervals on body, there being one around the middle of caudal peduncle and another at base of caudal; these last two indistinct. Vertical fins uniform dark grayish, pectorals and ventrals yellowish white.

Type is No. 5505 from Puerto Princessa, Palawan Island, P. I. Length, 35 millimeters.

Named for Doctor Boulenger of the British Museum whose work on Palawan fishes I have found of great assistance.

Gnatholepis davaoensis Seale, sp. nov.

Head 3.75; depth 1.20; dorsal VI, 12; anal 11; scales about 26, in lateral series; cheek and opercle scaled; eye 3.75 in head; snout 3.75; interorbital a mere ridge; maxillary 2.85, ending on a line with anterior margin of eye; mandible 2.

Upper and lower outlines of body about evenly and equally curved, depth of caudal peduncle 2 in head, its length 1.25 in head. Head rather bluntly rounded, the mouth oblique, jaws equal, tongue strongly bilobed, teeth in upper jaw in several series, the outer one being enlarged curved canines. Teeth of lower jaw in two series, the outer one of curved projecting canines, a large recurved canine on each side. No barbules, margin of preopercle entire. No filamentous pectoral rays. No mucous cirri.

The body and head, except snout and chin, are fully scaled, the scales being large, thin and smooth, three rows on cheeks.

Origin of spinous dorsal, midway between tip of snout and base of fifth dorsal ray, the longest spine 1.30 in head, about equal to longest ray. Caudal rounded, a fourth longer than head. Origin of anal is midway between end of caudal vertebra and angle of mouth, being on a line with the second dorsal ray, its longest ray equal to head. Ventrals very long, equal to caudal, their tips reaching to anal, their origin much nearer tip of snout than to anal, being directly below the base of the pectoral. Pectorals equal to head.

Color dull yellowish gray with 6 dusky blotches along sides, three or four distinct black dots at base of caudal, a black band from eye to middle of throat, some scattered black specks over body and indistinct indication of some dusky bars over back. Spinous dorsal grayish with several scattered dusky spots and ten black dots on lower part of fin. Soft dorsal grayish, anterior rays with slight indications of darker cross bars. Caudal grayish with numerous indistinct brownish dots and several larger distinct black spots on lower half of fin. Anal is most peculiarly colored with round black and white spots alternating as on a checker board. Ventral grayish with a black margin, pectorals grayish.

Type is No. 3858 from Samal Island, Gulf of Davao, Mindanao, P. I. Length, 45 millimeters.

This may be identical with the fish called *G. deltoides* by Jordan and Seale in Fishes of Samoa, but their specimens differ decidedly from the type of *G. deltoides* in lacking the characteristic markings which were present in all our 18 specimens from Guam, and in our Philippine specimens also, which are, however, different from the Guam form, therefore we deem it best to give this present species a new name, and it is probable that the Samoan specimens, also represent a new species.

Vaimosa microstomia Seale, sp. nov.

Head 3.80; depth 3.50; dorsal VI, 8; anal 8; scales 27, 8 in vertical series; eye 3.75; snout 5.25; interorbital about one-half diameter of eye; maxillary 2.75 in head, its tip under anterior margin of eye; no filaments on pectorals, nuchal region and opercles fully scaled, cheeks otherwise naked, the cheeks proper being crossed by 2 short lines of mucous pores. No elongate rays or spines.

Upper and lower outlines of body about equally curved, snout is bluntly rounded, heavy, overhanging the mouth; upper jaw slightly projecting. Depth of caudal peduncle 1.50 in head, its length about equal to head. Mouth small. Tongue truncate. Teeth in minute bands in each jaw, no enlarged canines. No teeth on vomer or palatine. No barbules. Gill openings restricted to sides.

Body covered with firm smooth scales which have a slightly roughened margin. Origin of dorsal fin midway between tip of snout and last dorsal ray, the longest dorsal spine about 1.50 in head, there are seven scales in front of dorsal, there are seven rows of scales between origin of spinous dorsal and origin of soft dorsal, longest dorsal ray 1.50 in head. Caudal rounded and considerably longer than head. Origin of anal midway between end of caudal vertebra and the angle of preopercle, its longest ray 1.50 in head, ventrals much nearer tip of snout than to anal, their length equal to head. Pectorals equal to head.

Color yellowish, specked and blotched with brown, some larger dusky blotches along median line, under surface white, about seven indistinct dusky bars over back. A dusky line from eye obliquely downward and backward to in front of preopercular angle. Opercles with a large dusky blotch, spinous dorsal with a large black blotch on its posterior portion. soft dorsal crossed by about six rows of small brown dots. Caudal with eight vertical brown lines. Anal yellowish with an indistinct dusky submarginal area. Ventrals and pectorals yellowish.

This species is especially characterized by the large rounded overhanging snout, the small mouth, and the small spinous dorsal.

Type is No. 827. Length 45 millimeters. From Malabon, Luzon Island, July, 1909.

Family CALLIONYMIDÆ.

Callionymus inversicoloratus Seale, sp. nov.

Head 3.65 (measured from pore to tip of snout) depth 5.75; width at base of pectorals 4.50; dorsal IV, 8; anal 7; no scales; lateral line distinct running along dorsal surface to slightly above the center of caudal; snout 2.30; interorbital space scarcely equal to pupil; maxillary about equal to orbit; mandible equal to snout; eye 2.40; preopercular spine short and strong with three branches of almost equal size, one directed backward, one directed outward and forward, one directed inward and upward.

This species has the characteristic shape of the callionymids, the depth of the caudal peduncle is less than eye, the snout is depressed and pointed, the interorbital space a mere ridge, not concave. The preorbital bones especially prominent. The mouth is large, the upper jaw rather heavy. Bands of small sharp teeth in jaws, none on vomer or palatine. Nuchal region with four bony asperites one in middle and back of interorbital space, one on each side of nuchal region and a small one in a median line behind these two. Gill openings confined to a pore on distal surface. Origin of dorsal midway between tip of snout and base of sixth dorsal ray, the spines not elongate, the longest 1.75 in head, the membranous portion somewhat quadrangular, longest dorsal ray 1.14 in head, the anterior and the posterior rays being longer than the others. Anal rounded, its length 2 in body. Origin of anal midway between tip of snout and base of caudal rays, its posterior ray the longest, being about equal to head, the first ray is directly on a line with second ray of soft dorsal, ventrals in front of pectorals, without free rays, their length greater than head. Pectorals scarcely equal to head.

The peculiar thing about this species is that the color pattern is inverted from the usual order; the back being uniformly grayish without markings while the entire ventral surface below the median line of sides is beautifully variegated and covered with brown spots with white ray-like markings, these white markings uniting into more or less distinct network, top of head plain gray, sides of head with blue lines and dots with some brownish blotches, a black spot at base of opercular spine and with a narrow dusky line extending from this spot to angle of jaws. Dorsal fins plain grayish, caudal white with three rows of vertical black dots and with the two lower rays dusky. Anal white at base, dusky on its outer half, some narrow blackish marks on center. Ventrals grayish with some dusky and some bluish specks. Pectorals whitish with several rows of smaller inconspicuous brown dots, about three brown spots on base of fin.

Type is No. 3748. from Samal Island, Gulf of Davao, Mindanao, P. I. Length, 60 millimeters. Ten cotypes.

Calliurichthys neptunia Seale, sp. nov.

Head 4.75 (measured from tip of snout to pore of gill openings); depth 11.75; dorsal IV, 9; anal 8; no scales; lateral line distinct and on the dorsal surface, extending out on caudal posteriorly; eye 3 in head; snout 2.30; interorbital less than pupil; a strong straight spine at angle of opercle, six short teeth on its anterior surface and a short spine directed forward at its base, caudal extremely elongate, about one and a half times longer than body without caudal; maxillary 2.75 ending on a line with anterior orbital ridge; mandible 2.55 in head.

Body rather flat, depressed and triangular shaped anteriorly in its lateral outline, cylindrical posteriorly; snout depressed. Interorbital

space a mere ridge. Depth of caudal peduncle 4 in head. Snout flat, its median depth about one-half its width. Jaws equal, the upper jaw protractile. Bands of short sharp teeth on each jaw, those in anterior of lower jaw largest, projecting, brush-like. Preopercle armed with spine described above, opercle unarmed. Gill opening confined to a small pore on dorsal surface just exterior to origin of lateral line. A roughened plate with ten tubercles on top of head posterior to eyes. Outline of spinous dorsal almost square, the 1st to 3rd rays elongate filiform, longer than the webbed portion, the longest dorsal ray is almost 2 in length of fish without caudal, the origin of spinous dorsal is midway between tip of snout and 3rd dorsal ray. Posterior ray of soft dorsal the longest 1.1 in head. Caudal lanceolate and elongate, the two median rays extremely filiform. Origin of anal slightly nearer tip of under jaw than to base of caudal, its anterior ray being on a line with second ray of dorsal, its longest ray equal to head. Ventrals jugular, their base connected by membrane with base of pectorals, their longest ray 3.50 in body without caudal. Pectorals about equal to head.

Color in alcohol brownish above with numerous black specks and line-like blotches, mingled posteriorly with small bluish white markings, uniform yellowish white below the middle of side, belly bluish white. A dark brown mark extending the length of throat becoming cross-shaped on the thorax. Branchiostegal membranes with numerous fine white longitudinal wave-like lines. A dusky bar vertically downward from eyes. Spinous dorsal dusky, somewhat lighter on its upper and lower borders. Soft dorsal white with numerous fine black broken lines and dots. Anal white at base, outer half black, bordered by a fine white line. Caudal with alternating white and black areas or bars. Ventrals grayish mottled with fine dots and lines. Pectorals with fine brownish specks, outer third of lower rays white.

Type is No. 2317 from Balayan Bay, Luzon, P. I., 20 January, 1908. Length, 190 millimeters, and cotype from same locality, length, 160 millimeters.

This species is quite different from *C. longicaudalis* with which I have compared it.

Synchiropus zamboangana Seale, sp. nov.

Head 3.70; depth 5.20; dorsal IV, 8; anal 7; body and head without scales, a single well-developed lateral line; eye 4 in head; snout 3; inter-orbital about equal to pupil; maxillary slightly less than eye, its tip scarcely reaching a line with eye; mandible 2.75 in head; preopercle with a single strong spine directed backward with two small spines on its interior side and two slightly larger spines directed forward on its outer side, the tip of the large spine ends in a line with the gill openings. Villiform teeth in jaws, none on vomer or palatine.

Body cylindrical, snout depressed and pointed, width of head almost a third greater than its depth; depth of caudal peduncle equal to snout.

A roughened asperite on nuchal region behind each eye, the space between these smooth, slightly concave. Interorbital space strongly concave, profile of snout concave, anterior ocular ridge especially prominent. Gill openings confined to a small pore on dorsal surface.

Origin of dorsal is midway between tip of snout and base of second dorsal ray, the anterior spine prolonged, the first 2.14 in length of fish without caudal, the remaining spines are graduate, the last being 2 in head, the origin of the soft dorsal is the width of the eye posterior to last dorsal spine, its longest ray equal to head and longer than its posterior ray. Caudal rounded, its length a third greater than head. Origin of anal midway between base of caudal and angle of ventrals, being below the third dorsal ray, its posterior ray is the longest 1.30 in head, differing in this respect from the shape of the soft dorsal, ventrals are in front of pectorals, a single detached anterior ray which is slightly less than length of head, length of ventrals 2.25 in fish without caudal; pectorals scarcely equal to head.

Color in life brown, marbled and mottled with drab and pale blue. Spinous dorsal brown on lower half, black on upper half, six large yellow spots in the membrane, four between the second and third spines, two between third and fourth spines. Soft dorsal mottled with yellow and brown, its distal third black. Caudal yellow, broadly margined with brown, a submarginal row of brown spots and two additional rows of brown spots on 4 upper rays near base and middle of fins respectively. Anal yellowish at base, dusky on outer two-thirds, about three longitudinal rows of bright blue dots extending the length of fin. Pectorals yellowish brown, with darker markings, ventrals yellowish brown, darker on outer third, the lower ray with about four brown bands and tipped with yellow.

Color in alcohol similar to above except that about five darker cross-bands show on the back, and the sides have whitish rings and ocelli; belly white; the spinous dorsal seems to have 3 or 4 dusky cross-bars and a dusky spot between the two last spines. The pectorals have about 5 cross-rows of dots, the lower rays uniform yellow, the ventrals are brownish except at base which has four pale brown bars extending into fin. Top of eyes dusky, some dusky markings on cheeks.

Type is No. 4456 from Zamboanga, Mindanao, P. I., 16 June, 1908. Length, 73 millimeters. Cotype No. 3070.

ILLUSTRATIONS.

- PLATE I. *Barbus ivis* Seale, sp. nov.
II. *Oxyporhamphus brevis* Seale, sp. nov.
III. Fig. 1. *Atherina regina* Seale, sp. nov. Fig. 2. *Atherina balabacensis* Seale, sp. nov.
IV. *Mugil joloensis* Seale, sp. nov.
V. *Mugil banksi* Seale, sp. nov.
VI. *Caranx auriga* Seale, sp. nov.
VII. *Caranx butuanensis* Seale, sp. nov.
VIII. *Epinephelus albimaculatus*, Seale, sp. nov.
IX. *Dentex filiformis* Seale, sp. nov.
X. *Lethrinus cutambi* Seale, sp. nov.
XI. *Lethrinus atkinsoni* Seale, sp. nov.
XII. Fig. 1. *Pomacentrus tropicus* Seale, sp. nov. Fig. 2. *Pomacentrus elongatus* Seale, sp. nov.
XIII. *Abudefduf coracinus* Seale, sp. nov.

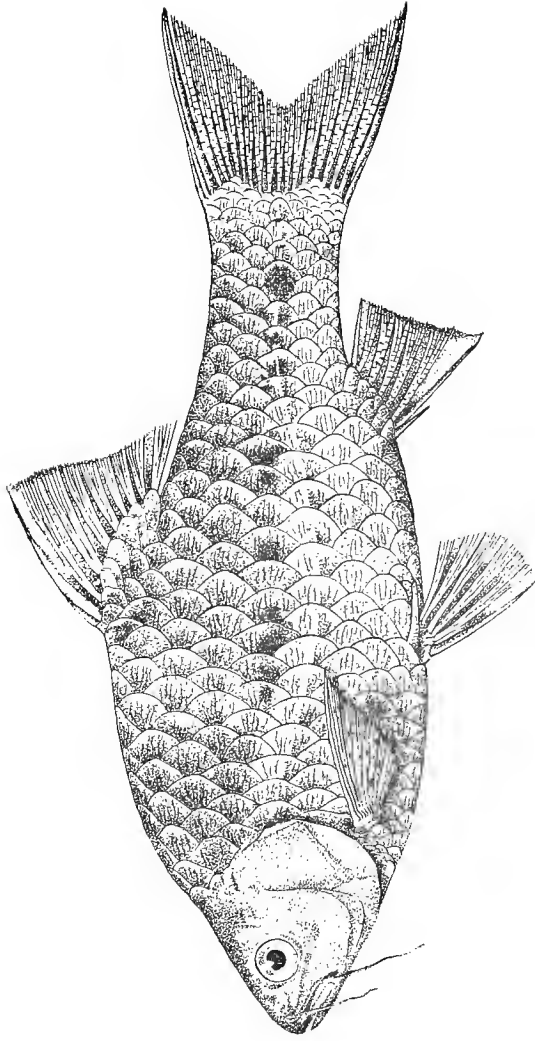

PLATE I. BARBUS IVIS SEALE, SP. NOV.

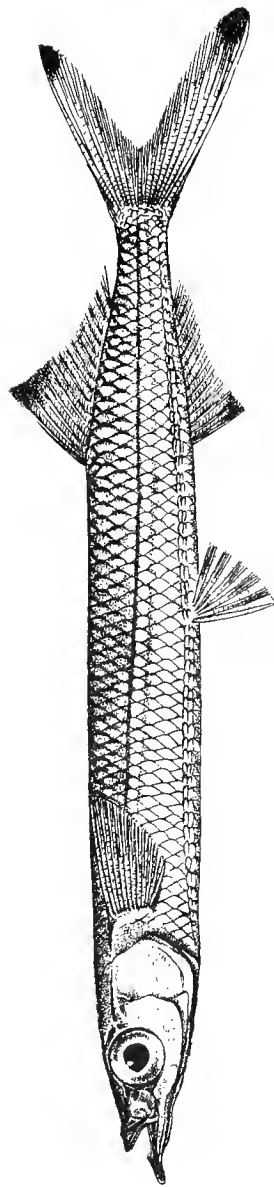

PLATE II. OXYPORHAMPHUS BREVIS SCALE. SP. NOV.

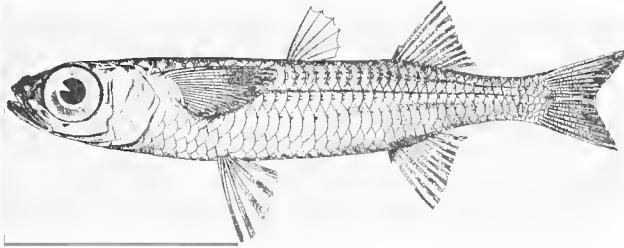

FIG. 1. *ATHERINA REGINA* SEALE, SP. NOV.

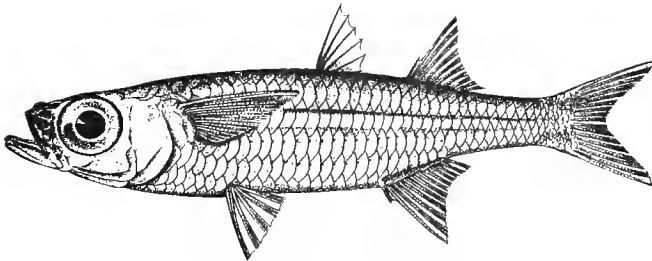

FIG. 2. *ATHERINA BALABACENSIS* SEALE, SP. NOV.

PLATE III.

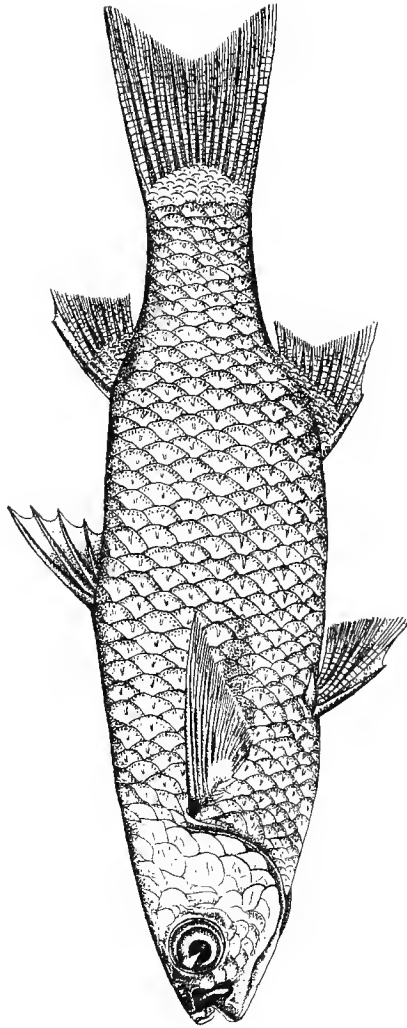

PLATE IV. MUGIL JOLOENSIS SEALE, SP. NOV.

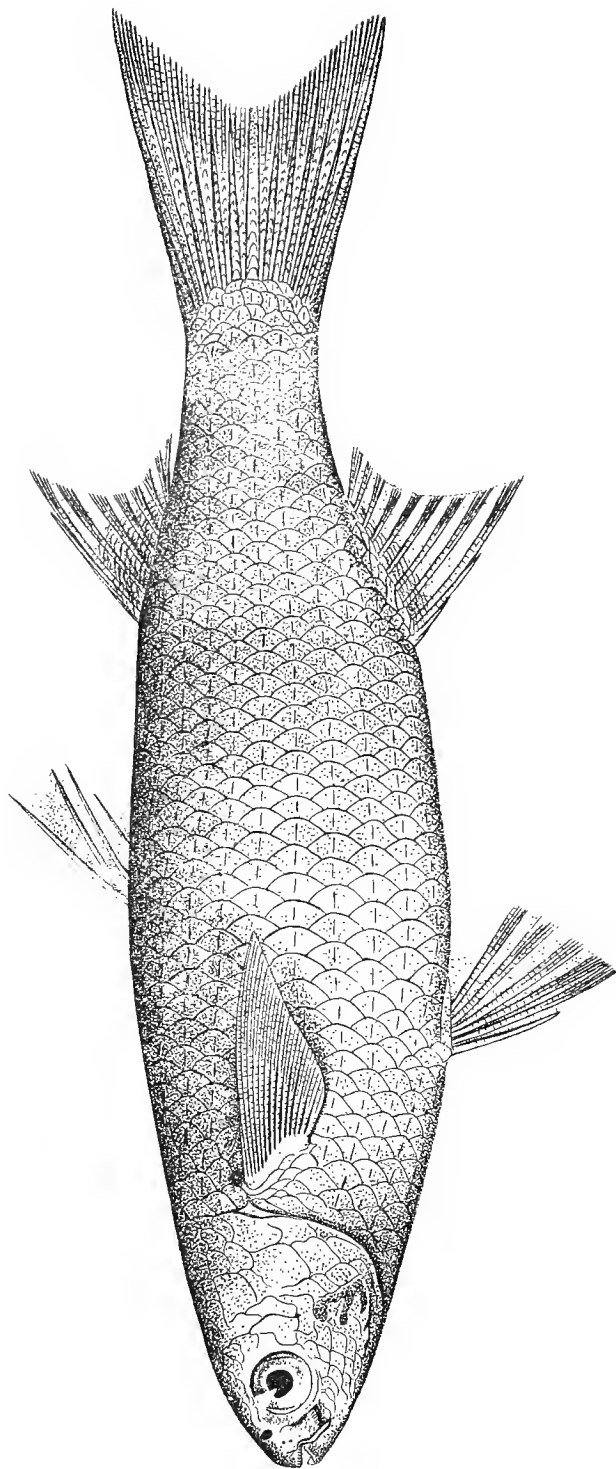

PLATE V. MUGIL BANKSI SEALE, SP. NOV.

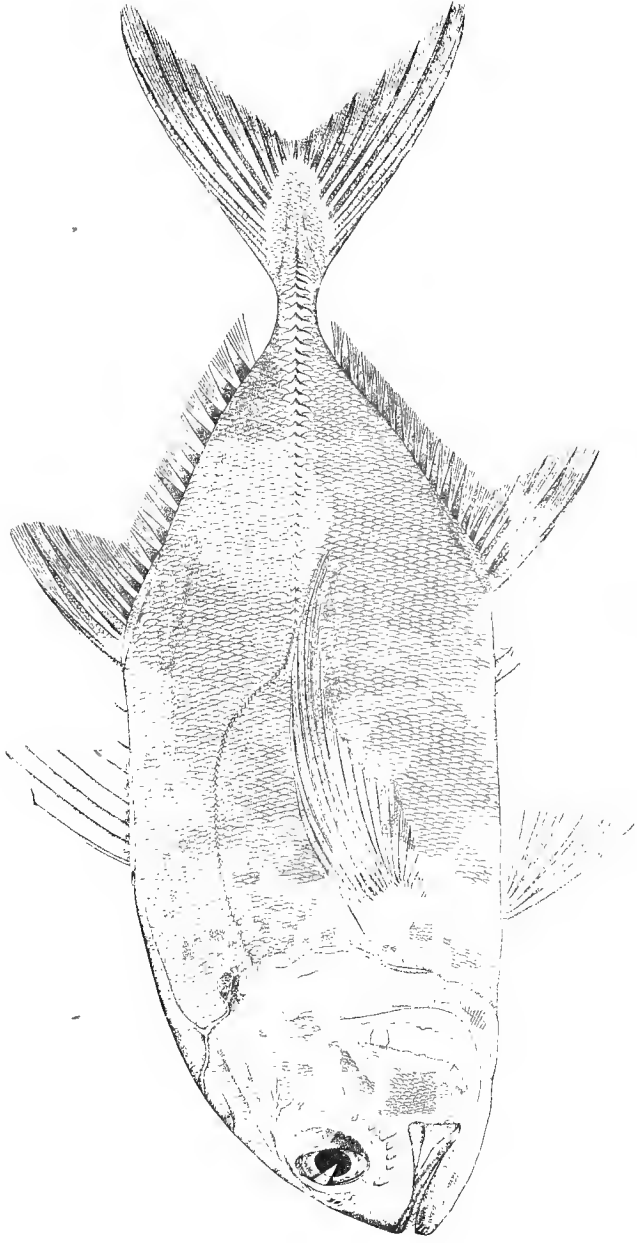
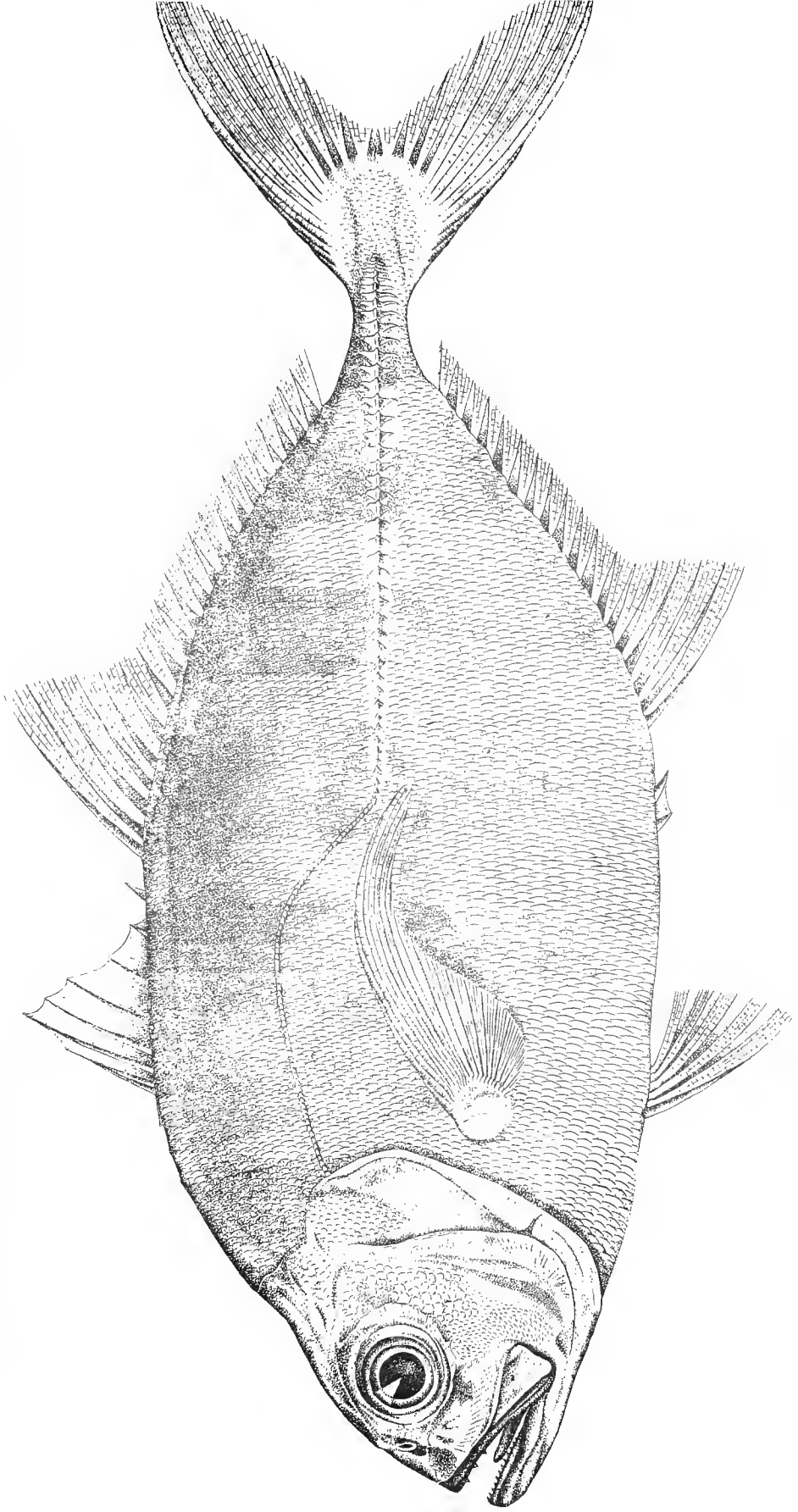

PLATE VI. CARANX AURIGA SEALE, SP. NOV.



SCALE: NEW SPECIES OF PHILIPPINE FISHES.]

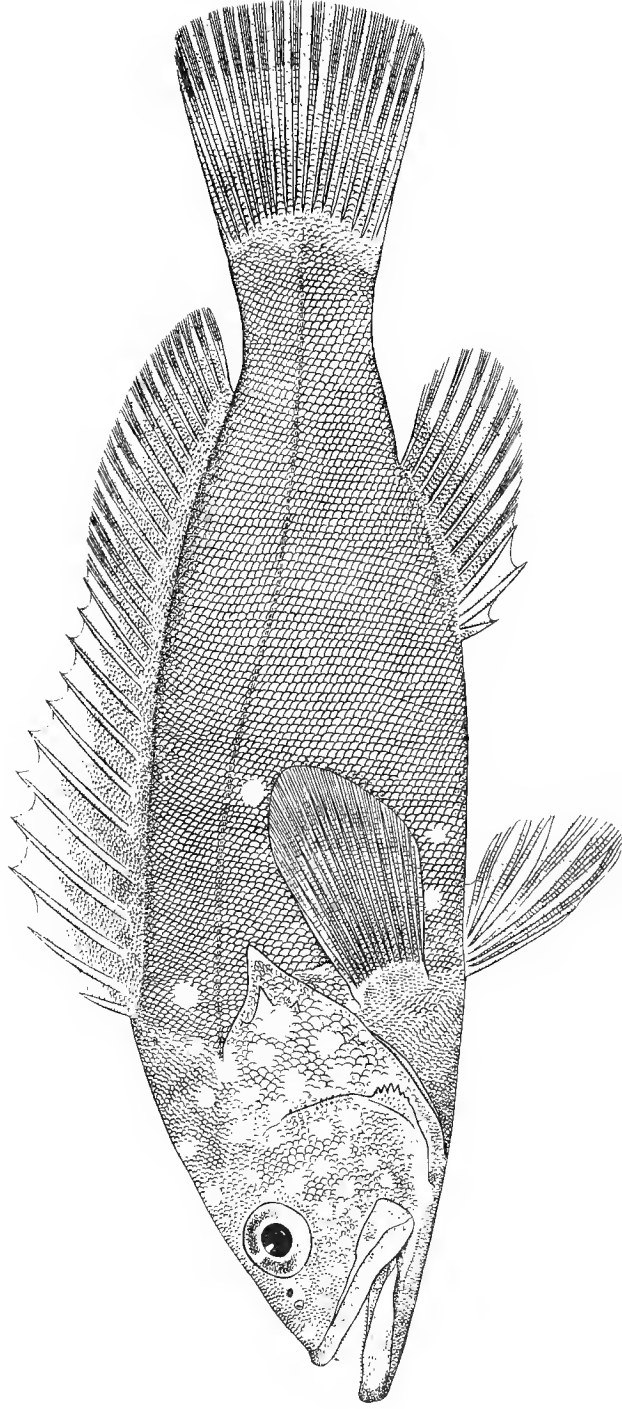

PLATE VIII. EPINEPHELUS ALBIMACULATUS SEALE, SP. NOV.

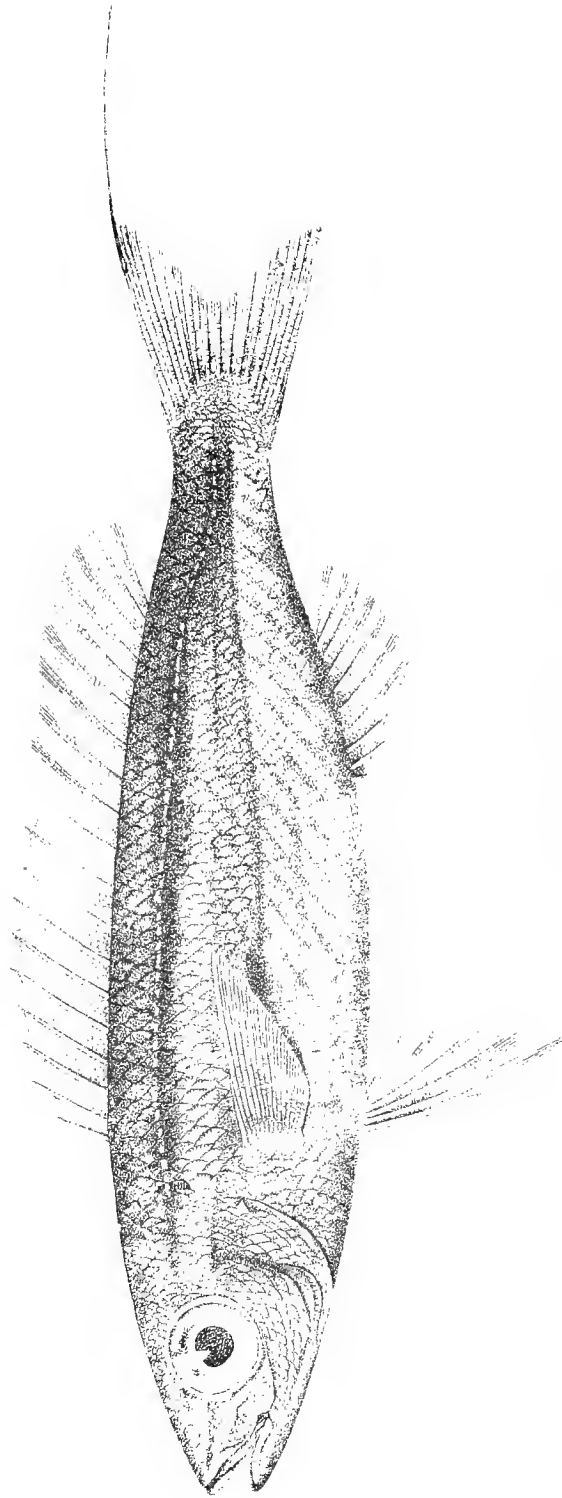

PLATE IX. DENTEX FILIFORMIS SEALE, SP. NOV.

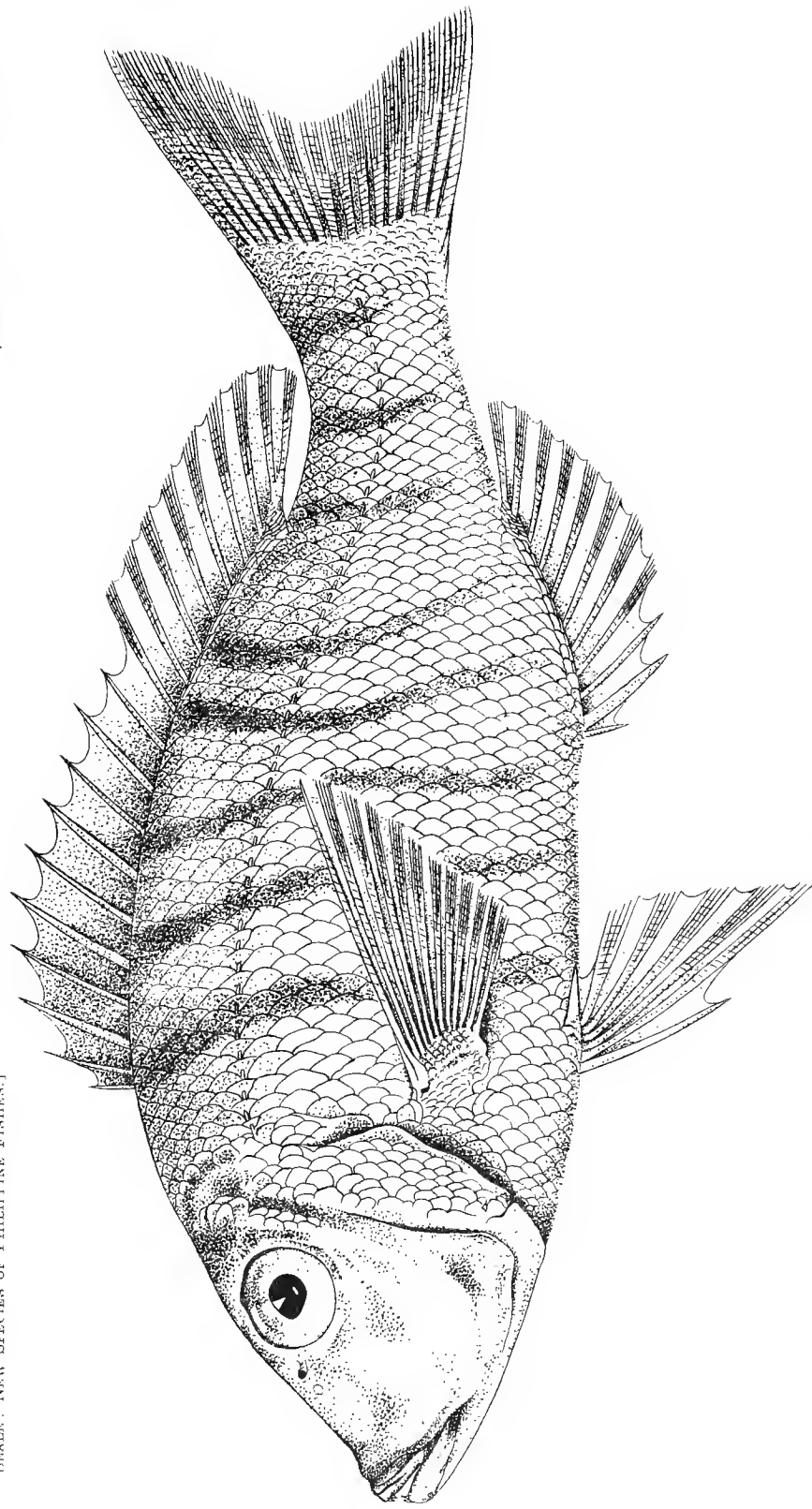
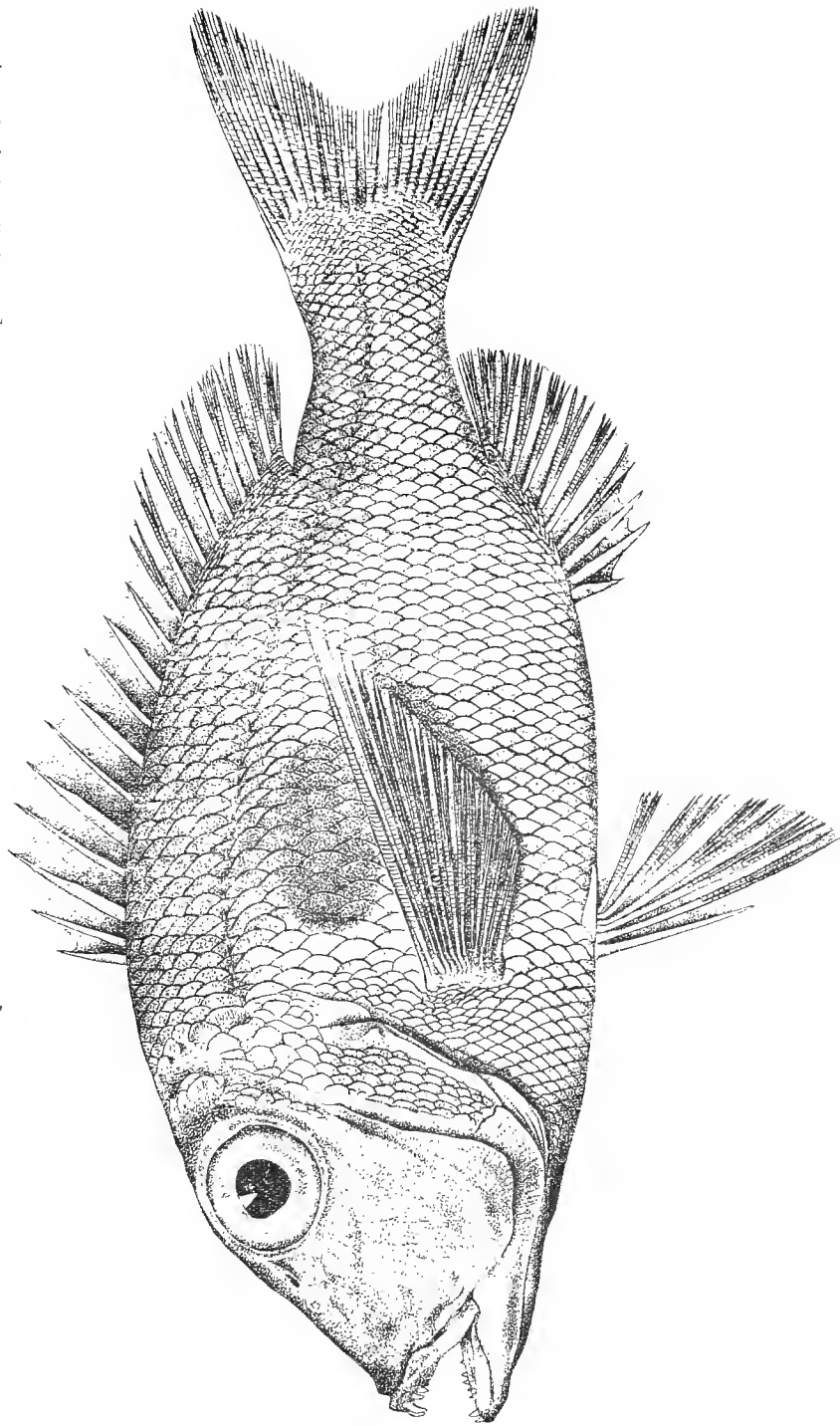

PLATE X. LETHRINUS CUTAMBI SEALE, SP. NOV.



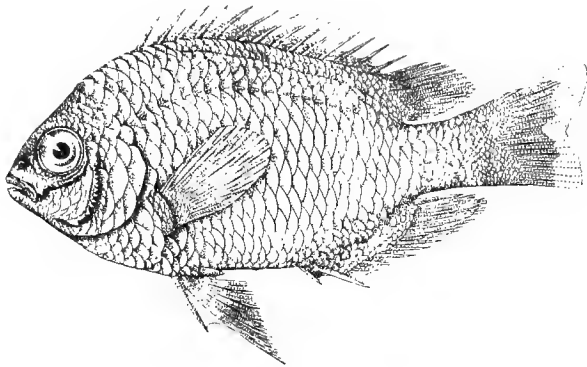

FIG. 1. POMACENTRUS TROPICUS SEALE, SP. NOV.

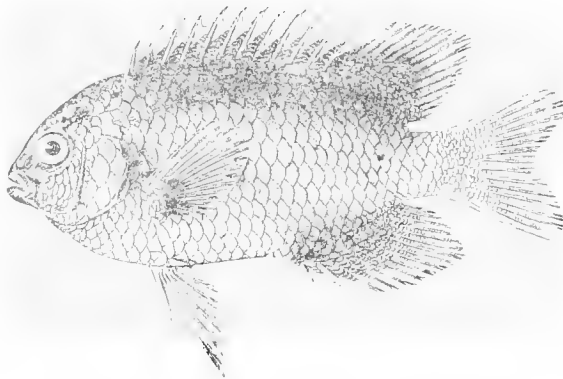

FIG. 2. POMACENTRUS ELONGATUS SEALE, SP. NO

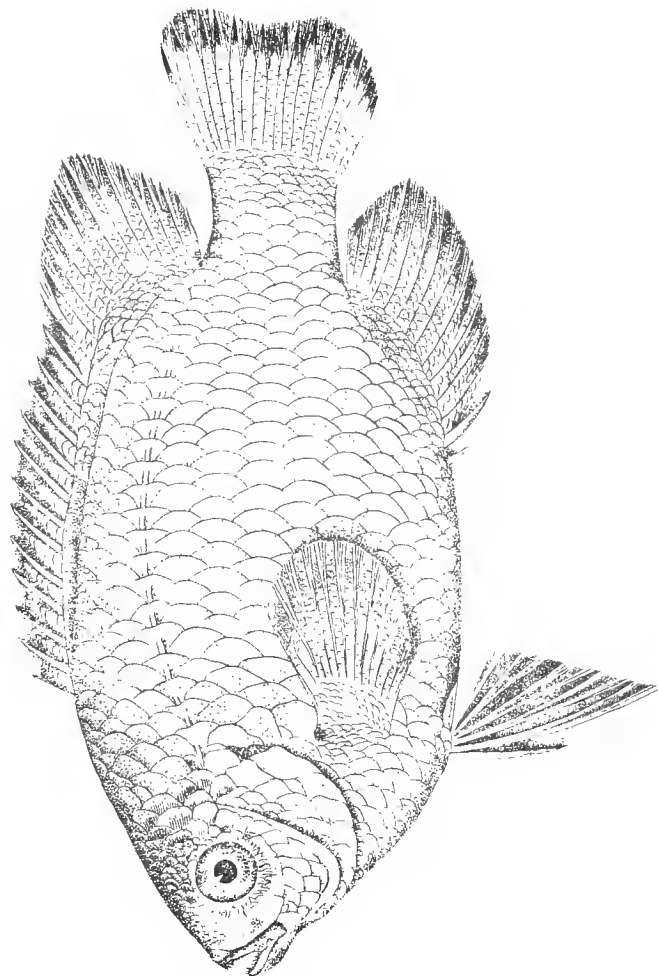

PLATE XIII. ABUDEFDUF CORACINUS SEALE, SP. NOV.

DESCRIPTION OF A NEW ACANTHOCYBIUM FROM THE
PHILIPPINE ISLANDS.

By ALVIN SEALE.

(From the Ichthyological Section, Biological Laboratory, Bureau of
Science, Manila, P. I.)

Acanthocybium forbesi Seale sp. nov. Forbes' Kingfish. (Plate I.¹)

Head 4 in length without caudal; depth 7.3; eye 10 in head, 5 in snout; dorsal XXVI 1119, 9; anal II 10, 8. The lateral line has its origin considerably above the opercles and is strongly curved under the 14-17 dorsal spines. In the posterior portion of its course the line is wavy. Between the strong curve of the line and the caudal, it gives off numerous short vertical branches, 77 above and 80 below the main line. These branches consist of true mucous canals with pores and with 2 rows of thin scales on each side; they are of various lengths, unbranched, and lie in a vertical plane, the lower branches extending half the distance to the anal fin and the upper branches half the distance to the dorsal fin. The lateral line proper is accompanied on each side by a narrow series of long thin scales.

The eye is located directly above the base of the mandible. The lower jaw is pointed and slightly the longer. The maxillary is attached in such a manner as to admit of considerable movement of the upper jaw. Each jaw has a single row of rather large compressed teeth which are rounded at the top. The teeth are very small at the tip of the jaw, but increase in size, posteriorly, to 12 millimeters in length; vomer and palatine somewhat roughened, but without teeth; opercle rounded with a very inconspicuous point posteriorly; preopercle toothed;

¹ In our figure of this species the vertical branches of the lateral line are emphasized, and the true lateral line shows but three rows of scales whereas there should be six.

pectoral fins on median line of the body, their origin on a line with the origin of the ventrals and of the spinous dorsal, being midway between the tip of the snout and the base of the 20th dorsal spine; length of pectoral is 1.90 in head; ventral 4.10 in head; spinous dorsal long, and free from the soft dorsal, its anterior spine the longest, being 5 in head. The remaining spines are but slightly less in length until the 23rd spine is reached. The 24th to 26th are graduated. Longest ray of soft dorsal 4.5 in head; its origin midway between the origin of spinous dorsal and the end of the caudal vertebra. There are 9 free, distinct pinnules, with 1 additional pinnule attached by membrane to the soft dorsal. Origin of anal directly below the 7th ray of the soft dorsal; the length of anal rays equal to rays of dorsal. There are 8 free pinnules behind the anal fin with 1 additional pinnule attached to the fin. The origin of the anal is slightly nearer the end of the caudal vertebræ than to tip of ventrals. The caudal fin is falcate with the middle rays slightly projecting.

The caudal peduncle is strongly keeled, with the addition of 2 small oblique keels on base of caudal fin.

The head is naked; a narrow corslet of thin scales surrounds the anterior portion of the body and embraces the base of pectorals and of ventrals; a narrow line of scales along base of spinous dorsal; a rather wide area of long thin scales on the belly, extending back to the origin of the anal, this area being of greater width than the distance between the base of ventrals. These scales are very distinct, being about 8 millimeters in length by 1 millimeter in width.

Color in life, a beautiful steel-blue above, becoming lighter on sides and below; the dense scaled area of belly being fulvous; some beautiful dark blue vertical stripes on sides, which disappear within a few moments after the fish is taken from the water; the dorsal is dark blue; the caudal is bluish; the ventrals, pectorals, and anal are white, the tip of the anal being slightly shaded with gray; the head is colored similar to the body.

Type is No. 7253; length, 1.7 meters (64 inches); weight, 29.5 kilograms (65 pounds); caught off the coast of Leyte by Dean C. Worcester, August, 1911.

Named in honor of Governor-General W. Cameron Forbes in recognition of his interest in the development of the fisheries of the Philippine Islands.

Upon my first examination of this fish, I regarded it as being identical with the species called *Cubium sara* Benn., from the Loo Choo Islands, but after carefully looking up all the descrip-

tions and literature² relating to this species (now called *Cybium solanderi* Cuv. and Val.), I am convinced that this species is distinct.

The most striking features of *A. forbesi* are the peculiar, long thin scales on the belly and the branches of the lateral line, points of which I am sure the numerous careful naturalists who have examined *C. solanderi* (*C. sara*) would not have failed to mention in their descriptions. Also Jordan and Evermann described *A. solanderi* as having serrated teeth. The teeth of our specimen are apparently smooth. The above and several other points of differences, especially in the location of the fins, seem to make it necessary to describe our specimen as a distinct species.

² Bennett, in Beechey's Voyage Zool. (1849), 63, Pl. 20, fig. 2.

Cuvier and Valenciennes, Histoire Naturelle des Poissons (1831), 8, 141.

Gunther, Fische der Südsee (1876), 2, Taf. 94, Figs. A und B; Cat. Fishes Brit. Mus. (1860), 2, 373.

Doderlein, Grom de Sc. Nat. Ed. Ecom. (1872), 8.

Jordan and Evermann, Fishes of North and Middle America (1896), Part I, 876, Bull. U. S. Fish Comm. (1903), Pl. 1, 176.

ILLUSTRATION.

PLATE I.

Acanthocybium forbesi Seale. Forbes' Kingfish. (Drawing by Espinosa.)

287

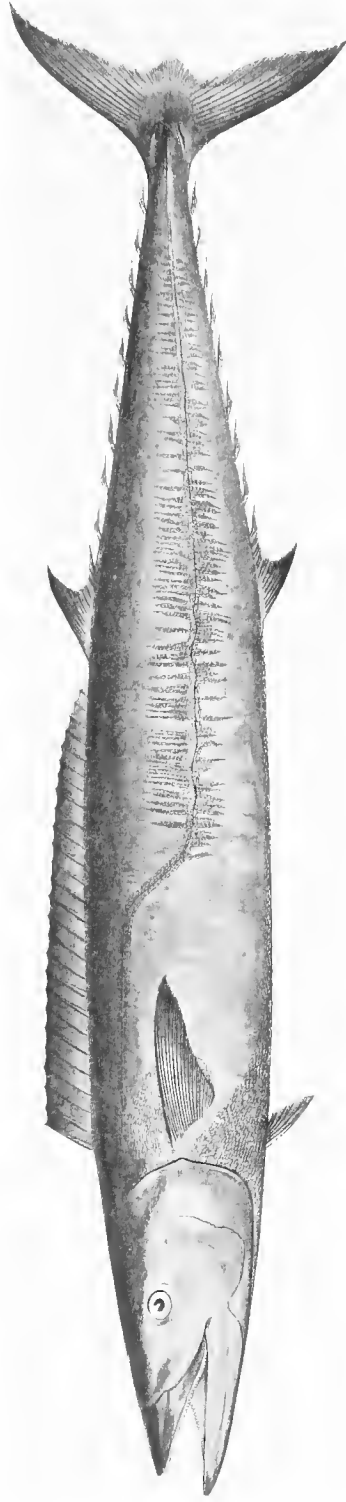

PLATE I. ACANTHOCYBIUM FORBESI Seale.



FISHES OF THE PHILIPPINE ISLANDS.

BY BARTON WARREN EVERMANN, A. M., PH. D., AND ALVIN SEALE, A. B.

Among the exhibits made by the U. S. Bureau of Insular Affairs at the Louisiana Purchase Exposition, held at St. Louis, Missouri, during the summer and fall of 1904, was a considerable collection of fishes from the Philippine Islands. This collection had been made under the direction of the Philippine government for the specific purpose mentioned. At the close of the exposition the authorities turned the entire collection over to the U. S. Bureau of Fisheries for study and report.

The localities represented in the collection are as follows:

San Fabian, Pangasinan, Luzon.—San Fabian is situated on the Gulf of Lingayen, about 100 miles north of Manila. The collection from this place was made by Mr. C. L. Hall and is a large and important one.

Bacon, Sorsogon, Luzon.—Sorsogon is the most southern province of Luzon. Bacon is situated in the northern part of the province, on Albay Inlet, in approximately latitude $13^{\circ} 3'$ north and longitude 124° east.

Bulan, Sorsogon, Luzon.—Bulan is on the west coast of Sorsogon, near the southern end of the province, approximately in latitude $12^{\circ} 38'$ north, longitude $123^{\circ} 22'$ east.

The collections from Bacon and Bulan are more extensive than any of the others. They were made by Prof. Charles J. Pierson, of Auburn, Nebraska, while a teacher in the Philippines.

Zamboanga, Mindanao.—Zamboanga, in the province of the same name, is at the extreme southern end of the western arm of Mindanao, in latitude $6^{\circ} 54'$ north and longitude 122° east. It is situated on the Strait of Basilan, about 500 miles south of Manila.

The specimens from this place were collected by Braulio Barbazco, who made also a small collection at Jolo, presumably on the island of Jolo.

The specimens were originally preserved in formalin in most cases, and afterwards transferred to alcohol. The excellent condition of most of the specimens in all of these collections indicates that the respective collectors did their work well and conscientiously, and the species represented show that the collecting was done intelligently and with proper discrimination. It is apparent that an intelligent and successful effort was made to have as many as possible of the important food fishes of the islands represented in the collections; and the large representation of the

smaller, less conspicuous species evidences the fact that methods of collecting were employed such as are known only to the trained naturalist. In this way many specimens of more than usual scientific interest were secured.

The fish-fauna of the Philippines has been but little studied. Enough is known, however, to show that it is an exceedingly rich one. Not only is it rich in species, but many of the species are abundant in individuals; indeed, many species occur in great prodigality.

Although the native methods employed in the fisheries are primitive, the methods of preparing the products of the fisheries for use equally primitive, and methods of preserving the products are practically unknown, nevertheless fish food forms a large and important item in the diet of the inhabitants of the Philippines. The natural food resources of Philippine waters are believed to be enormous, embracing not only a great number of fishes, but many species of edible mollusks, crustaceans, and algæ, which as yet are scarcely recognized in the islands as fit for food. The development of these resources is a matter worthy the best efforts of the government. Effort should first be directed toward determining what the resources really are—what species of fishes and other aquatic animals and what aquatic plants occur, how abundant each is, its geographic distribution among the islands, and its life history, including its food and its enemies. The present paper is a contribution to that end.

The collections upon which this report is based embrace a total of nearly 2,500 specimens, representing 89 families, 139 genera, and 296 species, of which 2 genera and 22 species are believed to be new, and are here described.

It has not been deemed necessary to give full descriptions of any species except those believed to be new. Ordinarily attention has been called only to those characters which will prove useful in identifying the species. All the specimens bear tin-tag numbers, and these are printed in the report in order that each specimen may be fully authenticated. The first series of specimens, including the types of all the new species, is deposited in the U. S. National Museum. The first duplicate series has been sent to the government museum at Manila. The second duplicate series has been deposited in the museum of Stanford University, and the third in the reserve series of the U. S. Bureau of Fisheries.

The vernacular names, printed in italics, are those furnished by the collectors. Only such synonymy is given as is necessary to connect this report with works which a student of Philippine fishes must consult in studying these species. Usually the first reference to any particular publication is made complete; subsequent references to the same publication are made more brief. In synonymy the name of the locality from which each species was originally described is printed in heavy-face type; other locality references are printed in ordinary type and are in parentheses.

Two editions of the *Histoire Naturelle des Poissons* by Cuvier and Valenciennes were consulted, the octavo edition of 22 volumes and the quarto edition, also of 22

NOTE.—We take this opportunity to thank Prof. Charles J. Pierson, of Auburn, Nebraska, for the use of his field notes, and Messrs. Edmund Lee Goldsborough and Howard Walton Clark, of the Bureau of Fisheries, for assistance of various kinds in the preparation of this report. The accompanying illustrations are from drawings by Mr. A. H. Baldwin and Miss Annie Swift Buckelew. Those made by Miss Buckelew are figures 11, 12, 15, and 17.

volumes. The dates of publication of these two editions are identical, but the pagination is different. In our references we have given the page of each edition, that of the quarto edition (the one in our library) first, followed by that of the octavo edition in parenthesis. The bibliography at the end of the report lists the more important publications consulted.

Family ELOPIDÆ.

1. *Elops saurus* Linnaeus.

One large specimen from Bulan (no. 4182; length 34 in.), agreeing in all essential respects with others from Florida.

Elops saurus Linnaeus, *Systema Naturæ*, ed. XII, 518, 1766, **Carolina**; Günther, *Catalogue Fishes British Museum*, VII, 470, 1868; Day, *Fishes of India*, 649, pl. CLXVI, fig. 1, 1878; Jordan & Evermann, *Fishes of North and Middle America*, pt. I, 410, 1896 (Oct. 3); Jordan & Evermann, *American Food and Game Fishes*, 86, fig., 1902; Jordan & Evermann, *Bull. U. S. Fish Comm.*, XXIII, pt. 1, 1903 (1905), 53, fig. 8 (Honolulu).

2. *Megalops cyprinoides* (Broussonet). *Buan-buan*.

Three specimens from Bulan (no. 4151, 4153, and 4183; length 10.5 to 16.5 in.) and one from Tarlac (no. 4132; length 11 in.).

Clupea cyprinoides Broussonet, *Ichth.*, I, pl. 9, 1782.
Megalops cyprinoides, Günther, *Cat.*, VII, 471.

Family CHIROCENTRIDÆ.

3. *Chirocentrus dorab* (Forskål). *Botete*.

Three fine specimens from San Fabian (no. 4179, 4180, and 4181; length 15.2 to 16 in.) and one from Bacon (no. 3410; length 13.25 in.).

Clupea dorab Forskål, *Descr. Anim.*, 72, 1775, **Red Sea**.
Chirocentrus dorab, Günther, *Cat.*, VII, 475; Day, *Fishes India*, 652, pl. CLXVI, fig. 3.

Family CLUPEIDÆ.

4. *Stolephorus delicatulus* (Bennett).

Two hundred and fifteen specimens from Bacon (no. 3915, 3502, 4080, and 4009; length 1.5 to 2.75 in.) and five from Bulan (no. 3756; length 2.75 in.).

Clupea delicatula Bennett, *Proc. Comm. Zool. Soc. London*, I, 168, 1831, **Mauritius**.
Spratelloides delicatula, Günther, *Cat.*, VII, 464.

5. *Stolephorus gracilis* (Temminck & Schlegel).

Three specimens from Bacon (no. 3768 and 3501; length 1 to 2.2 in.).

This species (with dorsal 11 and anal 13) can not be identical with *Atherina japonica* Houttuyn (with dorsal 17 and anal 22 or 23) as suggested by Dr. Jordan.

Clupea gracilis Temminck & Schlegel, *Fauna Japonica, Pisces*, 238, pl. CVIII, fig. 2, 1842, **Japan**.
Spratelloides gracilis, Günther, *Cat.*, VII, 465.

6. *Harengula moluccensis* Bleeker.

Ten specimens from Bacon (no. 3606 to 3609 3449 to 3551, 4026 and 4027, and 3932; length 4.2 to 5.75 in.) and 8 from Bulan (no. 3426 to 3432 and 3893; length 4.1 to 5.25 in.).

The base of the ventrals is under the middle of the dorsal, whose origin is much nearer tip of snout than to base of caudal, or midway between tip of snout and base of last anal ray. In Bleeker's figure of this species the ventrals are shown too far forward, as he explains in the text.

Harengula moluccensis Bleeker, *Nat. Tijds. Ned. Ind.*, IV, 1853, 609, Ternate; Amboyna; Günther, *Cat.*, VII, 427.

7. *Sardinella clupeioides* (Bleeker).

One specimen from Bulan (no. 3243; length 8.75 in.), agreeing well with Bleeker's figure.

Amblygaster clupeioides Bleeker, Journ. Ind. Archipel., 73, 1849, Macassar, Celebes; Bleeker, Atlas, VI, 103, pl. CCLXXII, fig. 1.
Clupea clupeioides, Günther, Cat., VII, 425.

8. *Sardinella perforata* (Cantor).

Twelve specimens from Bacon (no. 3658 to 3669; length 4.5 to 5.5 in.), agreeing perfectly with Bleeker's figure and description.

Clupeonia perforata Cantor, Cat. Malayan Fishes, 294, 1850, Sea of Pinang.
Sprotella kowala Bleeker, Haringachtige Visschen, 28, Verh. Bat. Gen., XXIV, 1852, Batavia.
Clupea perforata, Günther, Cat., VII, 424.

9. *Ilisha hævenii* (Bleeker). *Trübac*.

One specimen from San Fabian (no. 4127; length 6.5 in.).

Pellawa hævenii Bleeker, Haringachtige Visschen, 21, Verh. Bat. Gen., XXIV, 1852, Batavia; Günther, Cat., VII, 455.
Ilisha hævenii Bleeker, Atlas, VI, 117, pl. CCLXIX, fig. 2.

Family DOROSOMATIDÆ.

10. *Konosirus thrissa* (Linnæus).

Three fine specimens (no. 4170 to 4172; length 8 to 8.5 in.), without definite locality. Last dorsal ray extending to base of caudal.

Clupea thrissa Osbeck, Reise nach Ostindien und China, 336, 1765; Linnæus, Syst. Nat., ed. x, 318, 1758.
Clupea nasus Bloch, Ichth., XII, pl. CCCCXXIX, fig. 1, 1797.
Chatoessus nasus, Günther, Cat., VII, 407.
Dorosoma nasus, Bleeker, Atlas, VI, 142, pl. CCLX, fig. 4.

11. *Anodontostoma chacunda* (Buchanan-Hamilton). *Cabashi*.

Two fine specimens from Bacon (no. 3231 and 3232; length 6.1 and 7.1 in.). This species lacks the dorsal filament.

Chupanodon chacunda Buchanan-Hamilton, Fish. Ganges, 246, 1822, Ganges River.
Chatoessus chacunda, Günther, Cat., VII, 411.
Chatoessus selangkat Bleeker, Haringachtige Visschen, 47, Verh. Bat. Gen., XXIV, Batavia.
Dorosoma chacunda, Bleeker, Atlas, VI, pl. CCLXI, figs. 5 (var. *selangkat*) and 6.

Family ENGRAULIDÆ.

12. *Anchovia indica* (Van Hasselt).

Ten specimens from Bulan (no. 3989 and 3973; length 3.5 to 5.2 in.).

Engraulis indicus Van Hasselt, Algem. Konst-Letterbode, 329, 1823.
Engraulis russellii, Günther, Cat., VII, 390.
Stolephorus indicus, Bleeker, Atlas, VI, 127, pl. CCLIX, fig. 2.

Family SYNODONTIDÆ.

13. *Saurida argyrophanes* (Richardson). *Bitilla*.

Two specimens from San Fabian (no. 3673 and 3674; length 7.1 and 7.75 in.) and one from Zamboanga (No. 4083; length 7.5 in.).

Saurus argyrophanes Richardson, Ichth. Chin., in Rept. Brit. Assoc., xv, 1845, 302.
Saurida argyrophanes, Günther, Cat., V, 400, 1864.
Aulopus elongatus Temminck & Schlegel, Fauna Japonica, Pisces, 233, pl. cv, fig. 2, 1846.

14. *Saurida gracilis* (Quoy & Gaimard).

Three specimens from Bacon (no. 3983, 3984 and 3986; length 4.75 in.).

Saurus gracilis Quoy & Gaimard, Voy. Uran., Zool., 224, 1824, Sandwich Islands.
Saurida nebulosus, Günther, Cat., V, 399; Bleeker, Atlas, VI, 156, pl. CCLXXVII, fig. 1.
Saurida gracilis, Jordan & Evermann, Bull. U. S. Fish Comm., XXIII, pt. 1, 1903 (1905), 65 (Hilo and Honolulu).

15. *Trachinocephalus myops* (Forster).

One specimen from Bulan (no. 1129; length 8 in.).

Salmo myops Forster in Bloch & Schneider, Syst. Ichth., 421, 1801, St. Helena.

Saurus myops, Günther, Cat., v, 398.

Trachinocephalus myops, Jordan & Evermann, Bull. U. S. Fish Comm., XXIII, 1903 (1905), 62, fig. 13 (Hilo and Honolulu).

16. *Synodus varius* (Lacépède).

Two specimens from Bulan (no. 3670 and 3671; length 7 and 7.25 in.) and one from Bacon (no. 3982; length 4 in.).

Salmo varius Lacépède, Hist. Nat. Poiss., v, 224, pl. 3, fig. 3, 1803, Ile de France.

Saurus varius, Günther, Cat., v, 395; in part.

Synodus varius, Jordan & Evermann, Bull. U. S. Fish Comm., XXIII, pt. 1, 1903 (1905), 63, pl. II and fig. 14 (Hilo and Honolulu).

Family MYCTOPHIDÆ.

17. *Myctophum gilberti* Evermann & Seale, new species.

Head 3.5 in length; depth 4.5; eye 3 in head; dorsal XII; anal 16; snout 2 in eye; interorbital 1.5; scales large, thin, smooth, deciduous, 30 in lateral line.

Body oblong, compressed, the forehead evenly rounded; lower jaw extending slightly beyond upper; depth of caudal peduncle 3 in head, equal to diameter of eye; maxillary equal to postocular part of head, its distal end extending beyond eye a distance equal to one-half of orbit; mandible 1.7 in head; mouth oblique.

Teeth on jaws and palatines in narrow bands; no teeth on vomer; bands of teeth on mesopterygoids; 16 developed gillrakers on lower limb of first gill-arch, the longest 2 in eye.

Arrangement of photophores: Caudal 2, one at middle of caudal base, the other at origin of lowest caudal ray; posteroanals 4; anteroanals 6, the anterior one slightly separated from its fellows; ventrals 4, the anterior one in axil of ventral fin; thoracics 3; pectorals 3, in form of a triangle; mandibular 3; opercular 2;

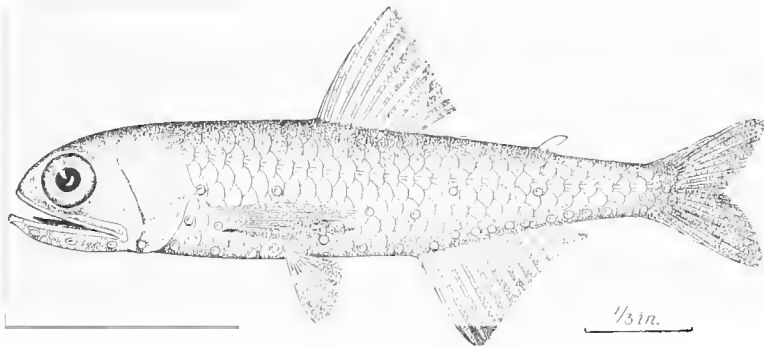

FIG. 1.—*Myctophum gilberti* Evermann & Seale, new species. Type.

posterolateral 1, very near lateral line and vertically on a line between interspace of anal photophores and base of adipose dorsal; mediolaterals 3, forming a very obtuse triangle, the upper one very near lateral line, the lower one midway between lateral line and origin of anal fin, a little too far front to form a true oblique line from posterior mediolateral to posterior ventral photophore, the anterior one on a horizontal line with the last and vertically over the posterior margin of second ventral; anterolateral 1, just above middle of pectoral fin and on first scale below lateral line.

Origin of dorsal fin midway between tip of snout and posterior anal photophore, the longest ray equal in length to distance from pupil to posterior margin of opercle; origin of adipose dorsal midway between posterior axil of dorsal and base of caudal; origin of anal midway between anterior thoracic photophore and lower caudal photophore, directly below axil of dorsal, its longest ray 1.5 in head; ventrals 2.5 in head, their origin below seventh scale of lateral line; pectoral long, 1.4 in head, tip extending to anterior mediolateral photophore; caudal forked, about 1.75 in head (mutilated).

Color in spirits, yellowish white; base of dorsal black; a black area at upper margin of opercle; a dusky band on anterior third of mandible; base of caudal and top of caudal peduncle dusky.

This species seems most nearly related to *M. reinhardtii* Lütken.

Four specimens from Bulan, length 2.1 to 2.5 in. Type (field no. 3841) no. 55900, U. S. National Museum; length 2.5 in., from Bulan, Sorsogon; coll. Charles J. Pierson. Of the 3 cotypes, 1 (field no. 3841) is no. 20,000, Stanford Univ. Mus.; another (field no. 3841) is in Museum at Manila, and a third (field no. 3841) is no. 4535, U. S. Bureau of Fisheries. Named for Dr. Charles H. Gilbert.

Family ANGUILLIDÆ.

18. *Anguilla mauritiana* Bennett. *Pabucang-binhi*.

One fine specimen from Tarlac (no. 4063; length 23 in.).

Anguilla mauritiana Bennett, Proc. Comm. Zool. Soc. Lond. 1831, 128, Mauritius.

Muraena manillensis Bleeker, Atlas, VI, 10, pl. CLXXXVIII, fig. 2, Manila, Luzon.

Anguilla mauritiana, Günther, Cat., VIII, 25.

Family MURÆNIDÆ.

19. *Gymnothorax richardsoni* (Bleeker).

One small specimen from San Fabian (no. 3842; length 5.2 in.).

Muraena richardsoni Bleeker, Nat. Tijds. Ned. Ind., III, 1852, 296, Wahai, Ceram; Günther, Cat., VIII, 118.

20. *Gymnothorax afer* Bloch.

One specimen from Bacon (no. 3769; length 2.5 in.), which we refer doubtfully to this species.

Gymnothorax afer Bloch, Ichth., XII, 73, pl. ccccxvii, 1797.

Muraena afra, Günther, Cat., VIII, 123.

Family PLOTOSIDÆ.

21. *Plotosus anguillaris* (Bloch). *Sumbilang*.

Eleven specimens from Jolo (no. 3352 to 3357 and 3421 to 3425; length 5 to 7 in.), eleven fine specimens from Bacon (no. 3365 to 3368, 3475 to 3480 and 4034; length 5.1 to 7 in.), and 48 young from Bacon (no. 4031; length, 1 to 1.5 in.).

Platystacus anguillaris Bloch, Ichth., XI, 49, pl. ccclxxi, fig. 1, 1797.

Plotosus anguillaris, Günther, Cat., V, 24.

Family SILURIDÆ.

22. *Netuma thalassinus* (Rüppell). *Tabomomo*.

One specimen from San Fabian (no. 3244; length 8 in.), three large specimens from Bulan (no. 4186, 4187, and 4188; length 19 to 20 in.); two small specimens from "Philippine Islands," without local label (no. 3939; length 3.5 and 5 in.).

Bagrus thalassinus Rüppell, Neue Wirb., Fische, 75, pl. 20, fig. 2, 1837, Massaua.

Arius thalassinus, Günther, Cat., V, 139.

Family FISTULARIIDÆ.

23. *Fistularia petimba* Lacépède. *Droal*.

Two specimens, one from San Fabian (no. 3407; length 15 in.), and one from Bacon (no. 4189; length 8.25 in.).

Fistularia petimba Lacépède, Hist. Nat. Poiss., V, 349, 1803, New Britain, Reunion Island; Jordan & Evermann, Bull. U. S. Fish. Comm., XXIII, 1903 (1905), 116 (Honolulu, Hilo, Kailua, Necker Island, and Hanalei Bay, Kauai; also Japan, Samoa, Philippines, and Papeete, Tahiti).

24. *Fistularia serrata* Cuvier. *Sivisivi*.

Three young from Bacon (no. 3984; length 9 to 12 in.).

Fistularia serrata Cuvier, Règne Anim., ed. 1, vol. 11, 349, 1817, America; Günther, Cat., III, 533; Jordan & Evermann, Bull. U. S. Fish. Comm., XXIII, pt. 1, 1903 (1905), 116 (Honolulu).

Family CENTRISCIDÆ.

25. *Aeoliscus strigatus* (Günther).

Two specimens from Bacon (no. 3943; length 4.75 and 5 in.).

Amphisile strigata Günther, Cat., III, 528, Java.

Family SYNGNATHIDÆ.

26. *Gasterotokeus biaculeatus* (Bloch).

Fifteen specimens from Bacon (no. 3447 to 3451, 3505 to 3508, 3597 to 3599, 3600, 3601, 3991, and 4190; length 5.25 to 9.25 in.).

With the exception of no. 4190, these specimens are all pale green, with a more or less distinct dark stripe through the eye. The body is depressed, the dorsal surface of middle body ring being at least 2.5 in ventral, differing in this respect from specimen no. 4190, which is described as follows:

Head 5.2 in length; depth 5.1 in head, the greatest width of body 3.25 in head; snout 1.75; width of snout at middle one-third less than its depth; eye 4.5 in snout; interorbital 5.75; dorsal 41; rings 17+40; dorsal fin on anterior 10 caudal rings; anal opening on anterior caudal ring; origin of dorsal midway between tip of tail and nostril; tail prehensile, no caudal fin; body elongate, depressed, the ventral surface twice as wide as dorsal; plates without spines; pectoral 5.75 in head. Color greenish; snout with 2 indistinct greenish bands.

Syngnathus biaculeatus Bloch, Ichth., IV, pl. CXXI, figs. 1 and 2, 1797, no locality given.

Gasterotokeus biaculeatus, Günther, Cat., VIII, 194; Day, Fishes India, 681, pl. CLXXIV, fig. 5.

27. *Corythoichthys eleræ* Evermann & Seale, new species.

Head 7.2 in length; snout 2; eye 2.5 in snout; dorsal 29; rings 16-36; a single ridge across cheek; interorbital 1.75 in eye; snout cylindrical, its depth and width being equal; lower surface of head and ventral surface of snout forming a straight line; depth of body greater than its width; length of body including head

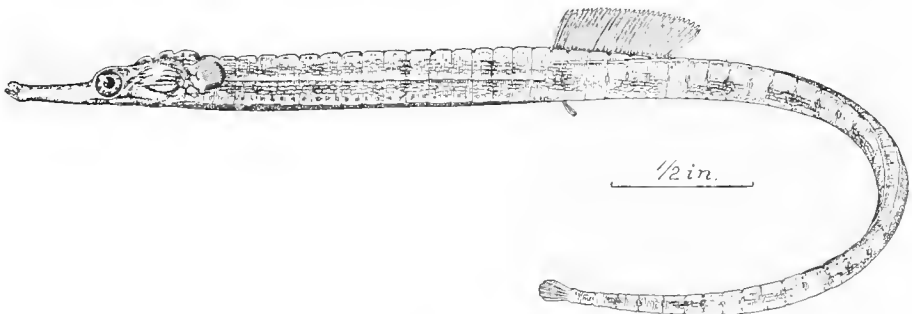

FIG. 2.—*Corythoichthys eleræ* Evermann & Seale, new species. Type.

1.45 in length of tail without caudal; a distinct nuchal ridge with 2 deep scallops; upper lateral margin of plates projecting, forming a scalloped margin on side of back; ventral surface of body rounded, dorsal surface concave; vent one ring in front of origin of dorsal; dorsal fin on anterior 6 rings of tail; origin of dorsal midway between tip of snout and twenty-fifth ring of tail; height of dorsal fin equal to depth of body at middle of fin; pectoral 14, its length 4.75 in head; caudal 2.2 in snout; anal rays 3, inconspicuous.

Color in spirits, pale green, with blotches of darker green on side; 3 black cross-bands on under part of thorax; some fine dark longitudinal lines on opercle, 3 on under part of head; no dark lines through eye; snout with about 5 indistinct bands of dots; a dusky blotch on base of pectoral (not always present); dorsal unmarked.

Very near *C. conspicuillatus* (Jenyns), but with longer snout, more posterior dorsal and the dorsal scales more roughened.

Eight specimens from Bacon (no. 3898 and 3944; length 4.2 to 4.75 in.).

Type (field no. 3944), no. 55908, U. S. National Museum, 4.75 in. in length, from Bacon, Sorsogon; collected by Chas. J. Pierson. Of the cotypes, each bearing field no. 3898, one is no. 20001, Stanford University Museum; another is no. 4536, U. S. Bureau of Fisheries, and one each is in the museum at Manila, the Philadelphia Academy of Natural Sciences, the U. S. National Museum, the Museum of Comparative Zoology, the Indiana University Museum, and the Field Museum of Natural History.

Family BELONIDÆ.

28. *Tylosurus giganteus* (Temminck & Schlegel).

Five specimens from Bacon (no. 3697, 3698, and 3378 to 3380: length 8.75 to 12 in.). These agree well with specimens from Hawaii.

Belone gigantea Temminck & Schlegel, Fauna Japonica, Pisces, 245, 1846, Nagasaki.

Belone annulata, Günther, Cat., vi, 240.

Tylosurus giganteus, Jordan & Evermann, Bull. U. S. Fish Comm., xxiii, pt. 1, 1903 (1905), 124, fig. 30 (Honolulu).

29. *Tylosurus leiuroides* (Bleeker).

One specimen from Bacon (no. 3519; length 11.25 in.); dorsal 21; anal 21.

Distinguished by the long nose and low dorsal fin.

Belone leiuroides Bleeker, Nat. Tijds. Ned. Ind., i, 1850, 479, Billiton; Günther, Cat., vi, 243.

Family EXOCETIDÆ.

30. *Hyporhamphus quoyi* (Cuvier & Valenciennes).

Three specimens from Bacon (no. 3460, 3617, and 3618; length 7 to 9.1 in.).

These agree well with Bleeker's figure.

Hemiramphus quoyi Cuvier & Valenciennes, Hist. Nat. Poiss., xix, 26 (35), New Guinea; Günther, Cat., vi, 267; Bleeker, Atlas, vi, 57, pl. ccl, fig. 3.

31. *Hyporhamphus dussumierii* (Cuvier & Valenciennes).

Four specimens from Bacon (no. 4005 and 3962: length 2.25 to 4.5 in.), and one from Bulan (no. 3739: length 10 in.).

We have compared these specimens with others from Samoa identified by Jordan and Seale as *H. affinis* and find them indistinguishable, and we regard *H. affinis* Günther as a synonym of *H. dussumierii*.

Hemiramphus dussumierii Cuvier & Valenciennes, Hist. Nat. Poiss., xix, 24 (33), pl. 554, Seychelles; Günther, Cat., vi, 266.

32. *Hemiramphus marginatus* (Forskål).

Four fine specimens from Bacon (no. 4160 to 4163; length 10 in.) agreeing with Bleeker's figure.

Esor marginatus Forskål, Descr. Anim., 57, 1775, Red Sea.

Hemiramphus marginatus, Günther, Cat., vi, 270; Bleeker, Atlas, vi, 54, pl. ccliv, fig. 4.

33. *Cypsilurus simus* (Cuvier & Valenciennes).

Two specimens from Bacon (no. 3308 and 3309; length 6.5 and 6.75 in.), two from Bulan (no. 3202 and 3203; length 9.2 and 9.75 in.), and one from the "Philippines," no definite label (no. 4164; length 9.3 in.). We have compared these with examples from Honolulu and find them to agree perfectly.

Exocetus simus Cuvier & Valenciennes, Hist. Nat. Poiss., xix, 77 (105), Hawaiian Islands.

Cypsilurus simus, Jordan & Evermann, Bull. U. S. Fish Comm., xxiii, pt. 1, 1903 (1905), 134, fig. 46 (Honolulu; Waimea and Hanamaulu Bay, Kauai; and Napili, Molokai).

34. Zenarchopterus dispar (Cuvier & Valenciennes)

One specimen, without lower jaw, and with mutilated caudal, probably belonging to this species, from Bacon (no. 4008; length, without bill, 4.5 in.). Dorsal XI; anal 11; scales 40.

Hemiramphus dispar Cuvier & Valenciennes, Hist. Nat. Poiss., XIX, 42 (58), pl. 558, 1846. **Java**; Günther, Cat., VI, 274
Zenarchopterus dispar, Bleeker, Atlas, VI, 63, pl. CCXIII, fig. 4.

35. Zenarchopterus philippinus Peters.

Forty-nine specimens from Bacon (no. 3384; length 3.5 to 4.5 in.). Dorsal 14; anal 15; head 1.5 in length; lower jaw 4.5 in head; scales 46; caudal forked.

Hemiramphus (Zenarchopterus) philippinus Peters, Monatsb. Kön. Akad. Wiss. Berlin 1868, 273, **Luzon**.
Zenarchopterus philippinus, Bleeker, Atlas, VI, 63.

Family ATHERINIDÆ.

36. Atherina temminckii Bleeker.

Two specimens from Bulan (no. 3997; length 2.5 and 3.5 in.), and one from Bacon (no. 3751; length 3 in.). Head 4 in length; depth 6.3; eye 2.8 in head; snout 4.1; interorbital 3; dorsal VI-I, 9; anal 12.

Atherina temminckii Bleeker, Nat. Tijds. Ned. Ind., V, 1853, 506, **Batavia**; Jordan & Seale, Proc. U. S. National Museum, XXVIII, 1905, 774 (Negros).

37. Atherina lacunosa Forster.

Five specimens from Bacon (no. 3961; length 2.75 to 3.75 in.).

Head 3.8 in length without caudal; depth 4.6; eye 2.75 in head; snout 4.5; interorbital 3; dorsal V-I, 10; anal 1, 13; scales 41-7; maxillary reaching vertical at anterior edge of pupil; origin of spinous dorsal slightly nearer anal than insertion of ventrals; no dark blotch on pectoral.

Atherina lacunosa Forster, Descr. Anim., 298, 1774, **New Caledonia**; probably not of Günther.

38. Atherina forskalii Rüppell.

Eighteen specimens from Bulan (no. 3833; length 2.1 to 3.2 in.), and 53 specimens from Bacon (no. 3653 and 3892; length 2 to 3.5 in.).

Atherina forskalii Rüppell, Neue Wirb., Fische, 132, pl. 33, fig. 1, 1835, **Belama**; Günther, Cat., III, 397; Day, Fishes India, 345, pl. LXXI, fig. 4.

Family MUGILIDÆ.

39. Mugil sundanensis Bleeker.

Nine specimens from Bacon (no. 3643 to 3651; length 4 to 6.2 in.).

Mugil sundanensis Bleeker, Nat. Tijds. Ned. Ind., IV, 265, **Sumatra**; Günther, Cat., III, 425.

40. Mugil planiceps Cuvier & Valenciennes.

Five specimens from Bulan (no. 3710 to 3714; length 6.5 to 8.75 in.).

Mugil planiceps Cuvier & Valenciennes, Hist. Nat. Poiss., VI, 90 (122) **Calcutta**; Günther, Cat., III, 428.

Family SPHYRÆNIDÆ.

41. Sphyræna jello Cuvier & Valenciennes.

Three specimens from Bacon (no. 4175 to 4177; length 13 to 14 in.) and 2 from Bulan (no. 4152 and 4153; length 16.35 and 19.5 in.). No. 4175 to 4177 are referred to this species with some doubt, as they are in such bad condition as to make the scale counts impossible, but in other respects they agree with *S. jello*.

Head 3.5 in length; depth 7.5; eye 6.4 in head; snout 2.1; interorbital 4.75; scales 16-130-20.

Sphyræna jello Cuvier & Valenciennes, Hist. Nat. Poiss., III, 258 (349), 1829, **Vizagapatam**; Günther, Cat., II, 337; Day, Fishes India, 342.

42. *Sphyræna obtusata* Cuvier & Valenciennes. *Dumbusan*.

One specimen from Bulan (no. 3411; length 7.5 in.). Head 3.1 in length; depth 6.1; eye 4.5 in head; snout 2.34.

Sphyræna obtusata Cuvier & Valenciennes, Hist. Nat. Poiss., III, 258 (350), Pondicherry; Günther, Cat., II, 339; Day, Fishes India, 343, pl. LXXI, fig. 5.

43. *Sphyræna langsar* Bleeker. *Domosot*.

One specimen from Bulan (no. 3412; length 8 in.), one from Bacon (no. 3942; length 5.5 in.), and 3 from San Fabian (no. 3677 and 4022; length 2.75 to 4.75 in.). These each have 75 scales in lateral line. This species is distinguished from *S. obtusata* by the longer snout and smaller scales.

Sphyræna langsar Bleeker, Nat. Tijds. Ned. Ind., VII, 367, Batjan; Günther, Cat., II, 340.

Family HOLOCENTRIDÆ.

44. *Myripristis pralinus* Cuvier & Valenciennes.

Two specimens from Bacon (no. 3223 and 3228; length 6.1 and 6.2 in.). These specimens show 6 indistinct yellowish longitudinal stripes below the lateral line. Depth 2.45 in length; head 3.25; eye 2 in head; snout 6.75; scales 4-38-6; dorsal x-1, 15; anal IV, 14; eye 6.1 in head; snout 3.5 in eye; large blunt projecting teeth in each jaw.

Myripristis pralinus Cuvier & Valenciennes, Hist. Nat. Poiss., III, 127 (170) and VII, 366 (486), New Ireland.

Myripristis bleekeri Günther, Cat., I, 20, 1859, Sea of Banda Neira; not *M. pralinus* of Günther.

45. *Myripristis microphthalmus* Bleeker.

Two specimens from Bacon (no. 3250 and 3723; length 7.25 and 7.5 in.) and one from Bulan (no. 3966; length 5 in.).

Head 3.25 in length; depth 2.45; eye 7 in head; scales 4-29-6; dorsal x-1, 14; anal IV, 12. These specimens agree well with others from Samoa.

Myripristis microphthalmus Bleeker, Nat. Tijds. Ned. Ind., III, 261, 1852, Amboyna; Atlas, IX, pl. cccclviii, fig. 2; Günther, Cat., I, 24.

46. *Myripristis murdjan* (Forskål).

Three specimens from Bacon (no. 3235, 3227 and 3637; length 6.25 to 8 in.), agreeing with Hawaiian specimens.

Sciæna murdjan Forskål, Deser. Anim., 48, 1775, Djidda, Red Sea.

Myripristis murdjan, Jordan & Evermann, Bull. U. S. Fish Comm., XXIII, pt. 1, 1903 (1905), 157, pl. v (Honolulu, Hilo, Kailua, Laysan, and Samoa).

47. *Myripristis macrolepis* Bleeker. *Baga-baga*.

One specimen (no. 3363; length 5.75 in.), from Zamboanga.

Head 3 in length; depth 2.3; eye 2.01 in head; snout 3 in eye; interorbital 3.75 in head; dorsal x-1, 15; anal IV, 12; scales 3-29-5, 6 scales in front of dorsal; maxillary 1.75 in head, its distal end under posterior margin of pupil.

Myripristis macrolepis Bleeker, Atlas, IX, pl. cccclix, fig. 3.

48. *Holocentrus cornutus* Bleeker.

One specimen from Bacon (no. 6919; length 5.25 in.) and one from Bulan (no. 6928; length 6.75 in.).

Head 3.2 in length; depth 2.8; eye 2.55 in head; snout 1.5; maxillary 3; mandible 2; scales 3-37-5; dorsal XI, 13; anal IV, 9, the fourth spine very long, nearly equal to head.

Color in spirits, yellowish, with dark longitudinal lines, the third from dorsal terminating in a dark caudal spot; membranes of spinous dorsal dark, first webs of anal black; outer margins of caudal dark.

Holocentrum cornutum Bleeker, Nat. Tijds. Ned. Ind., V, 240, Ceram; Günther, Cat., I, 45.

Family SCOMBRIDÆ.

49. *Scomber brachysomus* Bleeker. *Masanqui*.

One specimen from San Fabian (no. 3271; length 8.1 in.).

Gillrakers equal to distance from tip of snout to orbit, shorter than in *S. microlepidotus*, from which this species is easily distinguished by the deeper body.

Scomber brachysoma Bleeker, Nat. Tijds. Ned. Ind., i, 356, 1850, **Batavia**; Günther, Cat., ii, 361; Day, Fishes India, 251.

50. *Scomber microlepidotus* Rüppell.

Two specimens from Bacon (no. 4173 and 4174; length 10 and 10.25 in.). Gillrakers long, equal to distance from tip of snout to middle of eye.

Scomber microlepidotus Rüppell, Neue Wirb., Fische, 38, pl. xi, fig. 2, 1837, **Red Sea**; Günther, Cat., ii, 361; Day, Fishes India, 250, pl. LIV, figs. 3, 4, and 5; Fowler, Proc. Ac. Nat. Sci. Phila. 1904, 759.

51. *Scomber japonicus* Houttuyn.

One specimen from Bulan (no. 3912; length 5.45 in.). Blue above, silvery below. Head 3.25 in length; depth 5.2; dorsal ix, 12+v; anal ii, 11+v.

This species is indistinguishable from the common chub mackerel (*S. colias*) of the Atlantic.

Scomber japonicus Houttuyn, Verh. Holl. Maat. Weet. Haarl., xx, 1782, 331, **Japan**; Jordan & Evermann, Bull. U. S. Fish Comm., xxiii, pt. 1, 1903 (1905), 169, fig. 62.

52. *Gymnosarda pelamis* (Linnæus).

Two specimens from Bulan (no. 4184 and 4185; length 15 and 15.25 in.). Dorsal xvi—12+viii; anal ii—12+vii.

Scomber pelamis Linnæus, Syst. Nat., ed. x, 297, 1758, "in pelago inter Tropicos."

Thynnus pelamys, Günther, Cat., ii, 364.

Gymnosarda pelamis, Jordan & Evermann, Bull. U. S. Fish Comm., xxiii, pt. 1, 1903 (1905), 172, fig. 64.

53. *Rachycentron canadus* (Linnæus).

One fine specimen from Bulan (no. 4151; length 24 in.). Head 4.05 in length; depth 6.3; eye 7.1 in head; snout 2.5; maxillary 2.5; scales about 332; dorsal viii, 32; anal 27; lateral line with several strong sharp curves.

Gasterosteus canadus Linnæus, Syst. Nat., ed. xii, 491, 1766, **Carolina**.

Scomber niger Bloch, Ichth., x, 48, pl. cccxxxvii, 1797.

Elacate pondiceriana Cuvier & Valenciennes, Hist. Nat. Poiss., viii, 241 (329), 1831, **Pondicherry**.

Elacate niger, Günther, Cat., ii, 375.

Rachycentron canadus, Jordan & Evermann, Fishes North and Mid. Amer., 948, pl. cxlviii, fig. 401, 1896.

NESOGRAMMUS Evermann & Seale, new genus.

Nesogrammus Evermann & Seale, new genus of Scombridae (*Nesogrammus piersoni*).

Body long and slender, completely covered with small, thin, deciduous scales; no corselet; lateral lines 2, the lower branch leaving the main lateral line under the base of third or fourth dorsal spine, from which point it extends nearly vertically downward to lower third of side, along which it runs, approximately parallel to the ventral line of body, to caudal peduncle. Ventrals 1, 5; dorsal and anal finlets 7. Villiform teeth on vomer, palatines, and tongue; a single row of sharp, canine-like teeth in each jaw.

This genus is related to *Scomberomorus*, from which it differs, however, in the presence of two lateral lines and in the complete squamation of the body. (*νηβος*, island; *γραμμά*, line.)

54. *Nesogrammus piersoni* Evermann & Seale, new species.

Head 4.5 in length; depth 4.75; eye 4.35 in head; snout 2.85; maxillary 2.25; mandible 1.9; dorsal xii+i, 9+vii; pectoral 1.9; ventral 3.2; anal i, 11+vii; scales 170 in upper and 145 in lower branch of lateral line.

Body elongate, moderately compressed; depth of caudal peduncle 1.9 in snout; head pointed; jaws equal; interorbital space flat, its width greater than eye; mouth large; maxillary slipping under preorbital

and ending under anterior third of eye, its distal end formed by the supplemental bone, pointed and directed slightly upward; base of mandible under middle of eye; teeth in jaws in a single row, rather strong, triangular, about 14 to 17 on each side; minute teeth on vomer, palatines, and tongue; gillrakers rather bluntly pointed, 15 on lower limb, the longest 3 in snout; opercle and preopercle entire, the posterior margin of preopercle with a wide anterior curve in its middle portion; cheek and opercle with fine scales; body entirely covered with fine, thin deciduous scales; lateral lines 2, the upper beginning at upper edge of opercular opening and running approximately parallel with the back to below the sixth dorsal finlet, where it curves downward and unites with the lower branch; lower branch originating under base of third dorsal spine, running nearly vertically downward to level of lower edge of pectoral, where it curves backward and extends along lower third of side to middle of caudal peduncle, where it again unites with the upper branch; no corselet; breast scaled; caudal peduncle with a median keel and a smaller one above and below it.

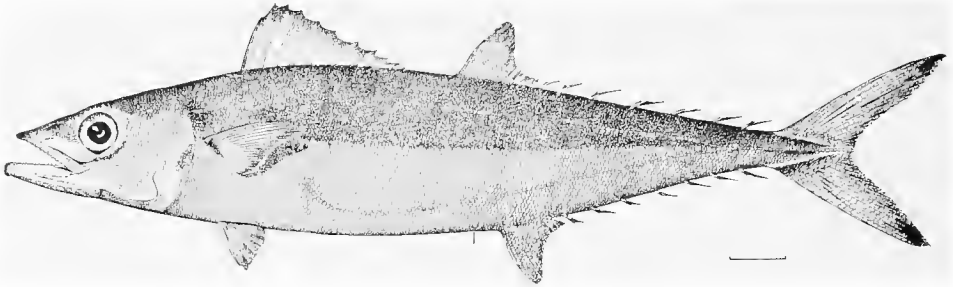

FIG. 3.—*Nesogrammus piersoni* Evermann & Seale, new species. Type.

Origin of spinous dorsal midway between tip of snout and third ray of soft dorsal; dorsal spines connected, except the 2 posterior ones, which do not protrude, the longest spine 2.75 in head, the 2 dorsals entirely separate; origin of soft dorsal slightly in advance of vent, its longest ray 2.75 in head; dorsal finlets 7; origin of anal midway between base of caudal and origin of ventrals, its longest ray 3.75 in head; anal finlets 7; no free spines in front of anal; origin of ventrals below axil of pectoral, their length 3 in head; caudal deeply forked.

Color in spirits, brownish above, silvery below; a large dusky blotch at origin of lateral line and in axil of pectoral; top of snout dusky; a dusky area through eye; membranes of spinous dorsal dusky; ventrals darker on posterior third; other fins with very slight wash of dusky.

One specimen (field no. 4178), the type, no. 55899, U. S. National Museum, 16 inches long, from Bulan, Sorsogon, P. I.; collected by Prof. Charles J. Pierson, for whom the species is named.

Family TRICHIURIDÆ.

55. *Trichiurus haumela* (Forskål). *Pinka*.

Head 7.5 in length; depth 14; eye 6.1 in head, 2 in snout; interorbital 2.5 in snout; dorsal 129; anal represented by 106 minute spines; teeth large, 18 in upper jaw, 20 in lower; no teeth on vomer, a few minute teeth on palatines; gillrakers consisting of small, sharp spines, about 14 on lower limb.

Color in spirits, silvery, bluish above; 2 bright yellow longitudinal stripes on lower half of body; dorsal yellow, with dusky margin.

One specimen from San Fabian (no. 3381; length 19.75 in.).

Clupea haumela Forskål, Descr. Anim., 72, 1775, Red Sea.

Trichiurus haumela, Günther, Cat., II, 348 (Malayan Peninsula; Amboyna).

Family CARANGIDÆ.

56. *Scomberoides toloo-parah* (Rüppell). *Cassising*.

Two specimens from San Fabian (no. 3716 and 3717; length 6.25 and 6.5 in.).

Lichia toloo-parah Rüppell, Atlas, Fische, 91, 1828, Massowah, Red Sea.

Chorinemus toloo, Günther, Cat., II, 473.

57. *Decapterus macrosomus* Bleeker.

Twelve specimens from Bulan (No. 3345, 3347 to 3349, 3351, 3521, 3522, 3524, and 3531 to 3534; length 5.75 to 8 in.) and one from Bacon (no. 4146; length 6 in.).

Depth 5.5; head 3.75; about 59 plates or scales in straight portion of lateral line; origin of ventrals nearer to tip of snout than to anal. This fish is more elongate and has smaller plates than has *D. kurra*, and the distance between tips of ventrals and origin of anal is 1.5 in head, while in *D. kurra* it is much less, being about 2.5.

Decapterus macrosoma Bleeker, Nat. Tijds. Ned. Ind., 1, 358, 1850, **Batavia**.

Caranx macrosoma, Günther, Cat., II, 425.

58. *Decapterus kurra* Bleeker.

Six specimens from Bulan (no. 3350, 3346, 3911, 3913, 3914, and 3523; length 4 to 6 in.)

Head 3 in length; depth 4.5; plates 40; distance between tips of ventrals and origin of anal short, about 2.5 in head; origin of ventrals nearer origin of anal than to tip of snout.

Decapterus kurra Bleeker, Makreelachtige Visschen, 50, Verh. Bat. Gen., xxiv, 1852, **Batavia**.

Caranx kurra, Günther, Cat., II, 427; Day, Fishes India, 214, pl. LXVIII, fig. 5.

59. *Seriola nigrofasciata* (Rüppell).

One specimen from Bulan (no. 3602; length 6.2 in.)

Nomeus nigrofasciatus Rüppell, Atlas, Fische, 92, pl. 24, fig. 2, 1828, **Red Sea**.

Seriola nigrofasciata, Günther, Cat., II, 465.

60. *Lactarius lactarius* (Bloch & Schneider). *Boq-snaq-taen*.

Three fine specimens from San Fabian (no. 3274, 3754, and 3755; length 6.25 to 9.2 in.).

Head 3 in length; depth 2.8; eye 3.85 in head; snout 4.5; maxillary 2.1, its distal end under posterior margin of pupil; base of anal fin 2.75 in length.

Scomber lactarius Bloch & Schneider, Syst. Ichth., 31, 1801, **Tranquebar**.

Lactarius delicatulus, Günther, Cat., II, 507.

61. *Caranx boops* Cuvier & Valenciennes. *Atoloy*.

Nine specimens from Bacon (no. 3724, 3807, 4053, 4054, 4084, 4085, 4086, 4102, and 4103; length 7 to 8.25 in.).

Head 3.45 in length; depth 3.1; plates of lateral line 44, the line strongly bent, becoming straight under the posterior third of first dorsal, the plates very large; eye 2.75 in head; adipose eyelid well developed; maxillary 2.1 in head.

In this species the ventrals fall far short of anal spines, the origin of the spines being midway between origin of ventrals and base of ninth anal ray; under jaw strongly projecting.

Caranx boops Cuvier & Valenciennes, Hist. Nat. Poiss., IX, 35 (46), **Amboyna**; Günther, Cat., II, 431; Day, Fishes India, 218, pl. XLIX, fig. 2.

62. *Caranx freeri* Evermann & Seale, new species. *Mataan*.

Head 3.1 in length; depth 3.2; eye 2.85 in head; interorbital 3.55; dorsal VIII—1, 23; anal II—1, 20; lateral line of 25 scales and 47 plates; a broad adipose eyelid.

Body oblong, moderately compressed; depth of caudal peduncle 6.1 in head, its depth less than its width; profile of head from above opercle to snout almost a straight line placed at angle of 35 degrees; mouth large, the lower jaw scarcely projecting; length of maxillary 2.1 in head, its distal end under middle of pupil, the posterior margin concave; mandible 1.75 in head; minute teeth on jaws, vomer, palatines, and tongue, those of jaws in single series; gillrakers long and slim, 24 on lower limb, the longest 5.9 in head; opercle and preopercle entire; body entirely scaled; breast scaled; plates of lateral line very strong, their greatest diameter 4.5 in head; the lateral line with a low curve anteriorly, becoming straight under the posterior dorsal spines, the curved portion 3.2 in straight; scales of the arrow-shaped area in front of dorsal very minute; about 6 rows on cheek; origin of spinous dorsal in vertical line with axil of ventrals, the longest spine 2 in head, longest ray of soft dorsal 2.5; origin of anal under second soft dorsal ray, being midway between base of caudal and posterior margin of orbit, its longest ray 2.55 in head; origin of anterior anal spine midway between origin of ventral and base of seventh anal ray; first anal spine 6.5 in head; ventrals midway between origin of anal and posterior end

of maxillary, their length 2 in head, their tips reaching first anal spine; pectoral 1.1 in head, the tip reaching origin of anal; caudal deeply forked, its length 1.1 in head.

Color in spirits, yellowish white, a tint of blue above; tip of snout and tip of under jaw dusky; no distinct opercular spot, but posterior margin of opercles with some slight shading of dusky; dorsals slightly tinted with dusky, most distinct on margin of soft dorsal; scarcely a trace of dusky on tip of caudal; pectorals, ventrals, and anal unmarked.

This species is near *C. boops*, of which we have many specimens. It may be at once separated, however, by the more anterior location of the anal spines, the less projecting under jaw, greater length of head, and greater width of the interorbital space.

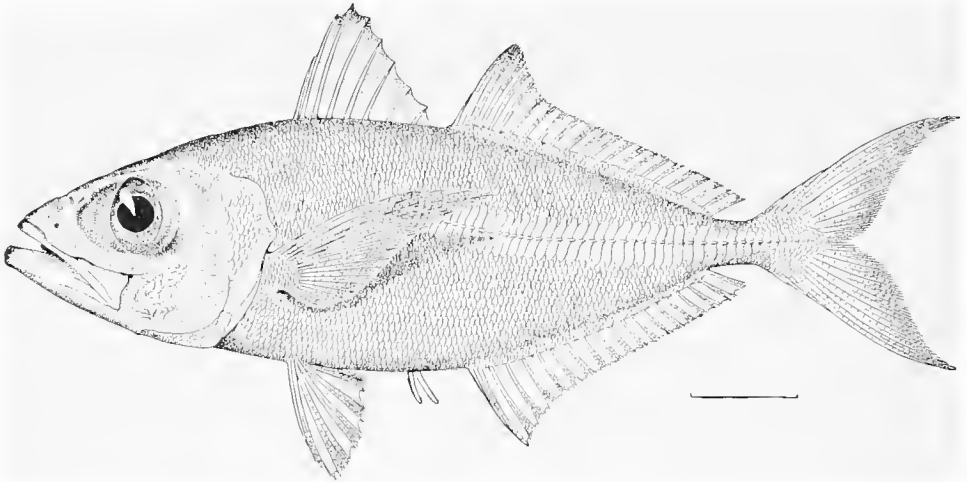

FIG. 4.—*Caranx freeri* Evermann & Seale, new species. Type.

One specimen (no. 3324, type, no., 55913 U. S. National Museum; 9.1 in. long), from San Fabian; collector, Mr. C. L. Hall.

We take pleasure in naming this species for Dr. Paul C. Freer, who, as director of the Philippine Bureau of Science, is doing so much to advance our knowledge of the natural resources of the Philippine Islands.

63. *Caranx cynodon* Bleeker.

One fine specimen from Bacon (?) (no. 4165; length 13 in.).

Head 3.4 in length; depth 2.9; eye 3.85 in head; snout 3.75; pectoral long and falcate, 2.75 in length; maxillary 2 in head, its distal end on line with posterior margin of eye.

Caranx cynodon Bleeker, Nat. Tijds. Ned. Ind., 1, 362, 1850, Batavia; Günther, Cat., II, 447.

64. *Caranx affinis* Rüppell.

Two specimens from Bulan (no. 3981 and 3897; length 5 and 5.5 in.). Differing from Hawaiian specimens apparently only in the somewhat larger black opercular spot.

Caranx affinis, Rüppell, Neue Wirb., Fische, 49, pl. 14, fig. 1.

65. *Caranx speciosus* (Forskål).

One specimen from Bulan (no. 3638; length 6.5 in.).

Scomber speciosus Forskål, Descr. Anim., 54, 1775, Red Sea.

Caranx speciosus, Günther, Cat., II, 444.

66. *Caranx ophthalmotænia* (Bleeker).

Four specimens from Bulan (no. 3907 to 3910; length 3 to 4.5 in.). Dorsal VIII, 27; anal II—I, 23; depth 2; head 3.05; anterior dorsal and anal rays elongate; a brown band from base of mandible upward and backward thru eye to nuchal region; ventrals dusky.

Carangoides ophthalmotænia Bleeker, Nat. Tijds. Ned. Ind., III, 270, 1852, Amboyna; Günther, Cat., II, 451.

67. *Caranx sexfasciatus* Quoy & Gaimard. *Talalitogan*.

Nine specimens from San Fabian (no. 3325 to 3333; length 3.5 to 4 in.). Head 3.1 in length; depth 2.5; eye 3 in head; snout 4.2; pectoral 3.3; maxillary 2.1, its distal end scarcely reaching posterior margin of eye; tip of dorsal black. *Carangus rhabdotus* Jenkins, from Honolulu, closely resembles this species, but differs from it in the heavier body, smaller eye, and the broader cross-bands.

Caranx sexfasciatus Quoy & Gaimard, Voy. Uranie, 358, pl. 65, fig. 4, 1824, **Papous Islands**.

68. *Caranx armatus* (Forskål). *Bucasang-sapse; Amaaligan*.

Sixteen specimens from San Fabian (no. 3498, 3446, 4940, and 4941; length 3.2 to 6 in.). No. 4032, length 3 inches, from Bulan, is also placed with this species, although it is slightly deeper and seems to differ in a slight degree.

Sciæna armata Forskål, Descr. Anim., 53, 1775, **Red Sea**.

Caranx armatus, Günther, Cat., II, 453.

69. *Caranx kalla* Cuvier & Valenciennes.

One specimen from Bulan (no. 3767; length 3 in.). Lateral line becoming straight under about the sixth dorsal ray, which readily distinguishes this species from *C. djeddaba*, to which it is closely related.

Caranx kalla Cuvier & Valenciennes, Hist. Nat. Poiss., IX, 37 (49), 1831, **Pondicherry**; Day, Fishes India, 219, pl. XLIX, fig. 5.

Caranx kalla, Günther, Cat., II, 433.

70. *Caranx djeddaba* (Forskål).

One small specimen from "Philippines" (no. 3782; length 3.5 in.).

Head 3.25 in length; depth 2.75; eye 3.2 in head; snout 4; maxillary 3; mandible 2.1; interorbital 3.75; dorsal VIII, 25; anal I, 22; scutes 54, 37 in curved portion; lateral line becoming straight under the first dorsal ray.

Scomber djeddaba Forskål, Descr. Anim., 1775, **Red Sea**.

Caranx djeddaba, Günther, Cat., II, 432; Day, Fishes India, 218, pl. XLIX, fig. 3.

71. *Caranx brevis* (Bleeker).

Three specimens from "Philippines" (no. 3888; length 3 to 3.2 in.).

Head 3.5 in length; depth 2.4; eye 3 in head; dorsal VIII, 25; anal II—I, 19; lateral line 34+46.

Teeth in jaws, vomer and palatines; no canines; curved portion of lateral line 1.95 in straight, the line becoming straight under anterior dorsal rays; a distinct opercular spot; breast scaled.

Selar brevis Bleeker, Nat. Tijds. Ned. Ind., I, 1850, 361, **Batavia**.

Caranx brevis, Günther, Cat., II, 435.

72. *Megalaspis cordyla* (Linnaeus). *Bacutut*.

Three fine specimens from Bulan (no. 4155 to 4157; length 14 to 15.5 in.) and 3 from Jolo (no. 4111 to 4113; length 8.5 to 9 in.).

Scomber cordyla Linnaeus, Syst. Nat., ed. x, 298, 1758, **America**.

Scomber rotteri Bloch, Ichth., x, 39, 346, 1797.

Caranx rotteri, Günther, Cat., II, 424.

Megalaspis rotteri, Bleeker, Makreelachtige Visschen, 49, Verh. Bat. Gen., XXIV (Batavia).

73. *Citula halli* Evermann & Seale, new species. *Pampanon*.

Head 3 in length; depth 1.5; eye 3.2 in head; dorsal IV—I, 40; anal II, 38; 76 scales in lateral line, 35 of which are in straight portion, and scarcely armed; snout 3.5; maxillary 3, its distal end on line with anterior margin of eye.

Body elevated, compressed; anterior profile rounded; caudal peduncle narrow, 5.5 in head; body, including breast, covered with deciduous scales, which are of small size on thorax; lateral line almost straight, the curve being very long and low, the greatest depth of curve 7 in its length, the straight portion of line 2.5 in curved part.

Depth of head much greater than its length; jaws equal; teeth very fine, sharp, in a single series in each jaw; no teeth on vomer, palatines or tongue; opercle and preopercle entire; gillrakers sharp, 13 on lower limb, the longest equal to one-half diameter of eye.

Spinous dorsal of 4 minute spines, connected only at base; anterior rays of soft dorsal and anal greatly elongate, the longest dorsal ray 2 in length; longest anal ray 2.25; caudal deeply forked, 3.5; pectoral 3.5; ventrals 4, their tips extending to base of anal; vertical fins without scaly sheath.

Color in spirits, yellowish, with 5 vertical brown bands of greater width than interspaces, the anterior one forming a distinct ocular band from spinous dorsal through eye to ventrals, the second from anterior of soft dorsal to belly, the third from fifth to fourteenth dorsal rays to anterior of anal; fourth from posterior

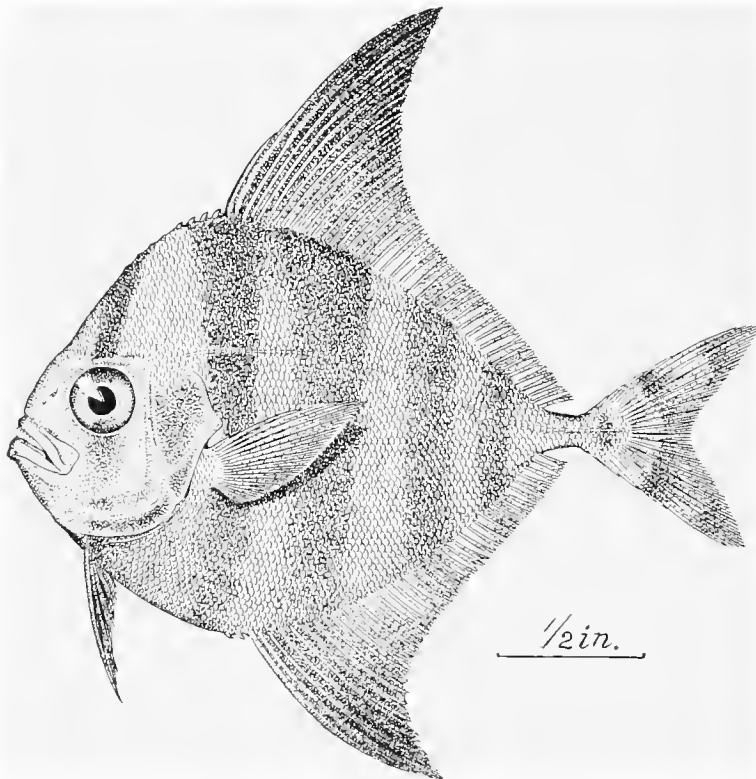

FIG. 5.—*Citula halli* Evermann & Seale, new species Type.

third of dorsal to middle of anal; the fifth near posterior of dorsal and anal; two oblique bands on each caudal lobe; anterior half of dorsal and anal black; ventrals black; pectoral yellowish; opercles dusky; belly with bluish wash.

One specimen, the type, no. 55914 U. S. National Museum (original no. 4029), 2.5 inches long, from San Fabian.

Easily distinguished from *Alectis ciliaris*, to which it bears a superficial resemblance, by the low curve of the lateral line. Named for Mr. C. L. Hall, who collected at San Fabian many of the specimens on which this report is based.

74. *Trachinotus baillonii* (Lacépède). *Bitilla*.

One specimen from Zamboanga (no. 3761; length 8.75 in.).

Head 3.8 in length; depth 2.3; eye 3.1 in head; snout 4.1; dorsal, anal and caudal lobes much produced, all blackish; 4 small round black spots on lateral line on middle of side.

Cæsiomorus baillonii Lacépède, Hist. Nat. Poiss., III, 93, pl. 3, fig. 1, Indian Ocean.
Trachynotus baillonii, Günther, Cat., II, 484.

Family EQUULIDÆ.

75. *Leiognathus virgatus* Fowler.

Two specimens from Bulan (no. 3916; length 2.5 and 2.75 in.).

Leiognathus virgatus Fowler, Journ. Ac. Nat. Sci. Phila., 2d ser., XII, 1904 (June 10), 515, pl. xv, fig. 4, Pedang, Sumatra.

76. *Leiognathus dussumieri* (Cuvier & Valenciennes). Malaway.

Two specimens from San Fabian (no. 3210 and 3212; length 6 and 6.2 in.).

Head 3.2 in length; depth 1.9; eye 3.1 in head; snout 3.1; spine-shaped crest on nuchal region not reaching halfway to base of first dorsal spine.

Equula dussumieri Cuvier & Valenciennes, Hist. Nat. Poiss., x, 56 (77), pl. 283, 1835, Coromandel; Günther, Cat., II, 500.

77. *Leiognathus splendens* (Cuvier). Masauqui.

Two specimens from San Fabian (no. 3955 and 3959; length 2.5 and 3.75 in.), one from "Philippines" (no local label, No. 3765; length 2.75 in.), and 3 from Bacon (no. 4030; length 2.5 to 2.75 in.).

Breast scaled; supraorbital serrate; lateral line not so strongly arched as in *L. edentulus*, the anterior part slightly concave; tip of dorsal black.

Equula splendens Cuvier, Règne Anim., II, 212, 1829, Indies; Günther, Cat., II, 501.

78. *Leiognathus stercorarius* Evermann & Seale, new species.

Head 3.7 in length; depth 3; eye 3 in head; snout 3; interorbital 3; dorsal VIII, 17; anal III, 14; scales 57.

Body oblong, moderately compressed, the upper and lower profiles almost evenly curved; jaws equal; depth of caudal peduncle 4.9 in head; entire body covered with thin deciduous scales; cheek and breast scaled; lateral line complete, with a long low curve from caudal peduncle to head; mouth very protractile; the groove for the processes of the maxillary extending to a line with posterior margin of eye, the length of the bony spine-shaped crest extending back from the groove 2.6 in head; upper jaw heavy; minute teeth

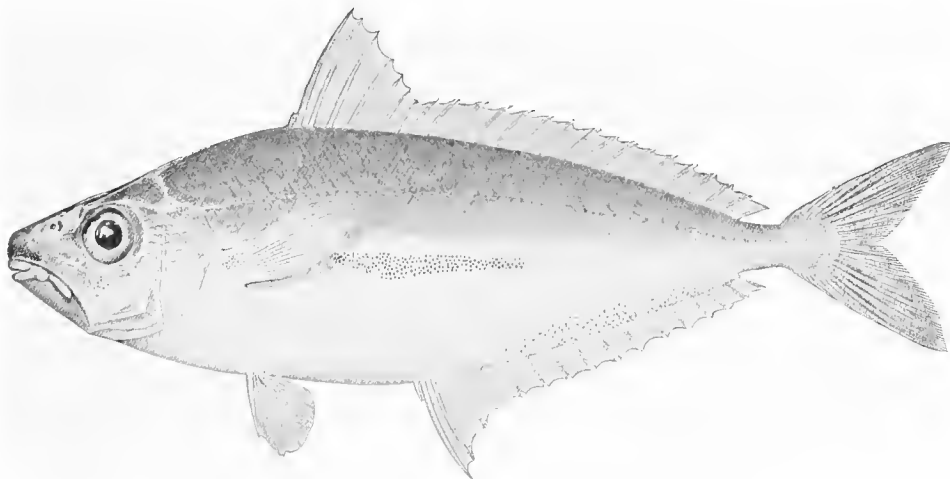

FIG. 6.—*Leiognathus stercorarius* Evermann & Seale, new species. Type.

in jaws, none on vomer, palatines or tongue; no canines; twelve gillrakers on lower limb, the longest about 2 in pupil; maxillary ending on a line with anterior margin of eye, scarcely one-half exposed; mandible 2 in head, at angle of 30°; width of preorbital 1.85 in snout; lower limb of preopercle denticulate on its inferior border; opercle entire; eye with slight adipose eyelid.

Origin of dorsal slightly posterior to origin of ventrals, longest dorsal spine 1.75 in head, about one-half depth of body (in another specimen—a cotype—this spine measures 1.4 in head and is greater than one-half depth of body), the first dorsal spine minute, the second longest, the dorsal continuous, none of the spines or

rays elongate; anal similar to dorsal but shorter; the first anal spine midway between tip of snout and base of caudal; the longest spine 2 in head, none of the anal spines or rays elongate; vertical fins without scales but with deep sheaths; pectoral 1.7 in head; ventrals 2.25 in head, their origin midway between origin of anal and posterior end of mandible; caudal deeply forked.

Color in spirits, light brown above, silvery below, with a slight wash of yellowish; a peculiar lanceolate area on middle of side shaded with fine black dots, and having the appearance of an abrasion; fine brownish dots just above anal fin; upper half of body with numerous vermiculate brownish lines; a black line on base of dorsal; upper lip dusky; dusky dots in axil of pectoral; anterior spines of dorsal and anal with some fine brown dots, most distinct on anal, otherwise fins unmarked.

This species is related to *L. oblongus* but differs among other things in having scales on chest. It is more elongate than *L. rivulatus* and *L. lineatus*, with which we have compared it.

Seven specimens from Bulan, length 3.75 to 4 in. Type, no. 55906, U. S. National Museum (field no. 3591), length 4.75 in., from Bulan, Sorsogon, P. I. Of the cotypes, all from Bulan, one (field no. 3590) is no. 20004 Stanford Univ. Mus.; another (field no. 3588) is no. 4537 U. S. Bureau of Fisheries; another (field no. 3587) is in the museum at Manila; another (field no. 3589) is in the U. S. National Museum; another (field no. 3592) is in Philadelphia Academy of Natural Sciences; another (field no. 3593) is in the Indiana University Museum. (*Stercorarius* of or pertaining to dung; from the fly-specks on the side.)

79. *Leiognathus edwardsi* Evermann & Seale, new species. *Patuan*.

Head 3.6 in length; depth 2.6; eye 2.75 in head; snout 2.9; interorbital 3.1; dorsal VIII, 16; anal III, 13; scales about 70, about 48 pores.

Body oblong-ovate, the dorsal and ventral outlines about equally curved and gently arched; head moderate, pointed, snout pointed; mouth small, very protractile, the lower jaw included; maxillary short, its exposed tip pointed, scarcely reaching vertical of orbit; teeth in jaws fine, villiform; vomer and palatines

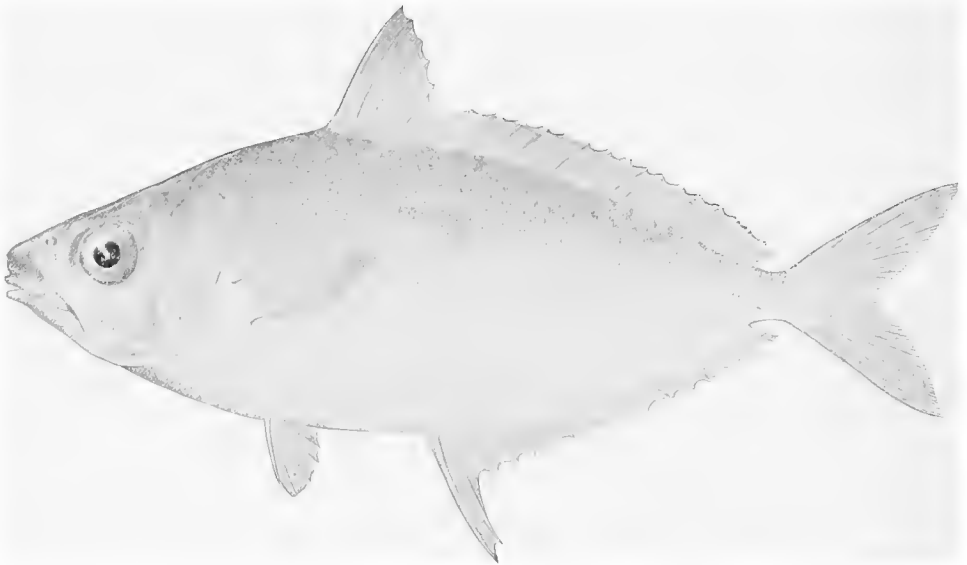

FIG. 7.—*Leiognathus edwardsi* Evermann & Seale, new species. Type.

apparently toothless; eye large, in middle of head; lower edge of preopercle entire; cheek deep, greater than interorbital width; a broad, blunt supraocular spine over anterior part of eye; interocular space broadest anteriorly, its length nearly twice its greatest width; occipital ridge greater than diameter of orbit and slightly greater than distance from its tip to origin of dorsal fin; origin of dorsal fin posterior to insertion of ventrals; first dorsal spine produced and filamentous (the tip broken off), its length probably about 1.5 in length of body; soft dorsal low; origin of anal under about sixth dorsal spine; first spine greatly produced and filamentous, its length about 1.8 in depth; anal rays short; both dorsal and anal fins folding into a

shallow groove; pectoral short, its length about 1.5 in head; ventrals short, their length slightly greater than diameter of orbit, the distance from their tips to base of first anal spine 1.5 in their length; caudal broadly forked, the lobes about 1.25 in head; scales small, thin, and deciduous; lateral line in a low regular arch from upper edge of gill-opening to base of caudal; breast naked.

Color in spirits, dirty olivaceous yellow, back more or less marbled and vermiculated with brownish; a dark line along base of dorsal fin; cheek and lower half of side finely punctulate with dark dots; tip of snout black; axil of pectoral dusky; fins otherwise pure yellowish.

This species is based on a single specimen 5 inches long, field no. 3876 (10778), from San Fabian, Pangasinan. Type, no. 55904, U. S. National Museum. It is apparently related to Günther's *Equula leuciscus*, from which it differs, however, in the smooth preopercle, the presence of a supraocular spine, and the less development of the anterior dorsal spine. We take pleasure in naming this species for Brig. Gen. Clarence R. Edwards, U. S. Army, Chief of the Bureau of Insular Affairs, U. S. War Department.

80. *Leiognathus fasciatus* (Lacépède).

Four specimens from San Fabian (no. 3211 and 3956 to 3958; length 3.25 to 6.2 in.).

Body very deep, back strongly arched. Head 3.18 in length; depth 2; eye 3 in head; snout 2.95; two strong supraocular spines; lower limb of preopercle serrate; scales very small, breast naked; lateral line complete, 60; body with about 18 narrow black vertical bars.

Chupea fasciata Lacépède, Hist. Nat. Poiss., v, 460, 1803.

Equula fasciata, Günther, Cat., II, 498, 1859.

81. *Leiognathus edentula* (Bloch).

Four specimens from San Fabian (no. 3950 to 3953; length 2.75 to 3.5 in.).

Body very deep, the back much arched; breast naked; lateral line strongly arched, the anterior part at first slightly concave.

Head 3 in length; depth 1.7; eye 3 in head; snout 2.75; nuchal crest almost reaching base of first dorsal spine, which is 2.5 in depth; teeth not evident; tip of dorsal fin not black.

Scomber edentulus Bloch, Ichth., pl. ccccxxxviii, 1785.

Equula edentula, Günther, Cat., II, 498; Day, Fishes India, 238, pl. LI, fig. 1.

82. *Gazza tapeinosoma* Bleeker.

Five specimens from the Philippines (no local label given; no. 3779, 3780, 3781, 3783, and 3784; length 3.75 to 5.2 in.), and 8 from Bulan (no. 3489 to 3496; length 4.5 to 5 in.).

Gazza tapeinosoma Bleeker, Nat. Tijds. Ned. Ind., iv, 260, 1853, Batavia.

Gazza argentaria, Günther, Cat., II, 506; probably not of Forster.

83. *Gazza minuta* (Bloch). *Matambo; Buegsang.*

Seven specimens from San Fabian (no. 3947 to 3949 and 3868 to 3871; length 2.75 to 4 in.).

Head 2.9 in length; depth 2; eye 2.75 in head; snout 3.1; scales minute, lateral line complete; breast naked; preopercle serrate.

Scomber minutus Bloch, Ichth., XII, 110, pl. ccccxxix, fig. 2, 1797, no locality given

Gazza minuta, Günther, Cat., II, 506.

Family GERRIDÆ.

84. *Xystæma punctatum* (Cuvier & Valenciennes).

Three specimens from Bulan (no. 3220 to 3223; length 4.75 to 5.2 in.), agreeing well with the figures given by Bleeker and by Day and with Day's description.

Gerres punctatus Cuvier & Valenciennes, Hist. Nat. Poiss., VI, 361 (480) 1830, Pondicherry.

Gerres filamentosus, Günther, Cat., I, 345, and IV, 261; Day, Fishes India, 98, pl. xxv, fig. 3.

85. *Xystæma baconensis* Evermann & Seale, new species. *Duldul.*

Head 3.25 in length, depth 2.6; eye 3.25 in head; snout 3; lateral line complete; scales about 4-47-8; interorbital 2.8 in head; maxillary 2.5; depth of cheek 3.3; dorsal IX, 10; anal III, 7; pectoral 1.1 in head; ventrals 1.9.

Body moderately elongate, the back rather strongly arched, the profile rising in a regular curve from tip of snout to origin of dorsal fin, thence descending in a broader curve to caudal peduncle; ventral outline less convex; head pointed, the lips thick, jaws subequal, or the lower slightly the shorter; premaxillary strongly protractile; exposed portion of maxillary broad, its greatest width half its length, its posterior edge slightly concave; preopercle entire; interorbital broad; premaxillary groove narrow, completely scaled except a small circular area posteriorly above anterior margin of orbit; caudal peduncle rather deep, its greatest depth greater than diameter of eye, or 3 times its least width. Scales large, thin, and firm; origin of dorsal fin over base of pectoral, the second spine slender, curved, and lengthened, its length greater than half that of head; dorsal rays short; second anal spine shorter and scarcely larger than the third, its length 1.4 in eye; dorsal and anal fins each with a high, scaly sheath; caudal fin thickly covered with fine scales; peritoneum dusky; second interhæmal spine long and slender; posterior end of air-bladder bifid, ending in 2 long slender horns which fit alongside of second interhæmal.

Color in spirits, silvery white, the back and upper part of side showing faint dark lines along the middle of each row of scales parallel with the back; tip of spinous dorsal dark, fins otherwise unmarked. This species is close to *X. kapas*, from which it differs chiefly in having the premaxillary groove scaled, the eye larger, the interorbital space broader, and the second anal spine smaller.

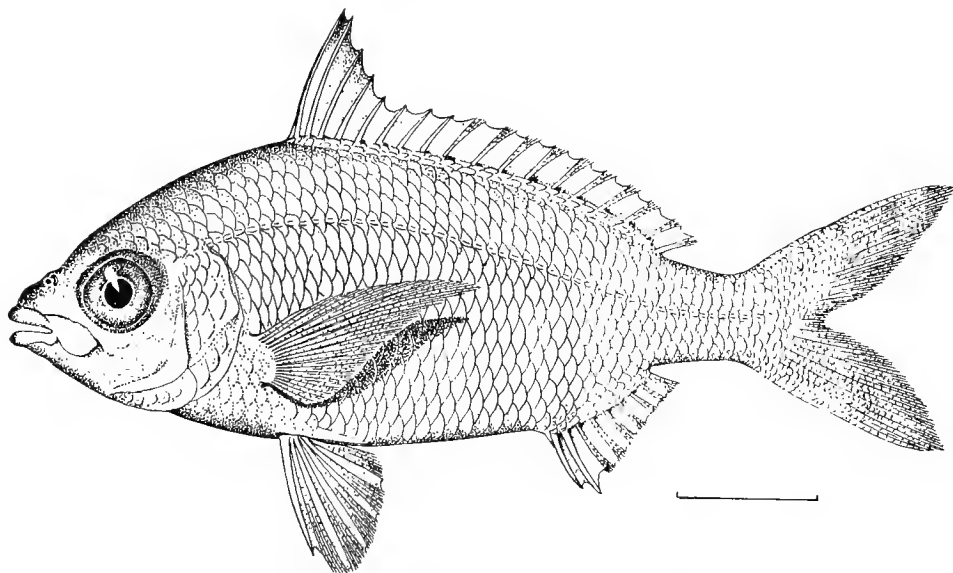

FIG. 8.—*Xystæna baconensis* Evermann & Seale, new species. Type.

This species is represented in our collection by two specimens—one (no. 3416) from Bacon, and the other (no. 3377) from Jolo. Type, no. 55912, U. S. National Museum, a specimen 7 inches long, from Bacon, Sorsogon, P. I. The other, a specimen 5.5 inches long is a cotype, no. 4538, U. S. Bureau of Fisheries.

86. *Xystæna kapas* (Bleeker). *Duldul*.

We refer to this species one specimen (no. 3376) 5.35 in. long from Jolo, 9 specimens (no. 3417, 3418, 3637 to 3639, and 3822 to 3825, 3.2 to 6.5 in. long) from Bacon, and 2 small examples (no. 3890) from Bulan.

Head 3.2 in length; depth 2.7, eye 3.5 in head; snout 3.2; interorbital 2.9; scales 4-40-9; maxillary groove naked, interorbital width greater than orbit; preopercle not denticulate; base of ventrals midway between tip of snout and origin of anal; longest dorsal spine about 2 in depth of body; second anal spine somewhat stronger but shorter than the third, its length 3.3 in head or 4.25 in depth.

Color in spirits, silvery, tip of spinous dorsal black; body without longitudinal darker lines.

Our specimens agree perfectly with Bleeker's figure of this species, but differ from Günther's description in the shorter second anal spine. They seem to differ from *N. oyena* (Rüppell) in the lower curve of the dorsal outline and the absence of dark lateral lines along the rows of scales.

Gerres kapas Bleeker, Nat. Tijds. Ned. Ind., II, 1851, 482, **Batavia**.

Diapterus kapas Bleeker, Atlas, VIII, 127, pl. CCCLXI, fig. 3 (East Indies).

Gerres kapas, Günther, Cat., IV, 259.

Family MENIDÆ.

87. *Emmelichthys leucogrammicus* Bleeker.

Nine specimens from Balan (no. 3971; length 2.5 to 3.2 in.), and one from Bacon (no. 3758; length 1.85 in.). These agree well with Bleeker's figure.

Emmelichthys leucogrammicus Bleeker, Nat. Tijds. Ned. Ind., I, 103, 1850, **Celebes**; Atlas, VII, pl. CCXCIV, fig. 2.

Erythrichthys leucogrammicus, Günther, Cat., I, 396.

Dipterygonotus leucogrammicus Bleeker, Atlas, VIII, 42.

Family SCORPIDIDÆ.

88. *Monodactylus argenteus* (Linnæus).

One specimen from Balan (no. 3594; length 3.75 in.). Head 2.9 in length; depth 1.2; eye 2.6 in head; snout 5.2. Color in spirits dusky silvery, a black band from nape through eye to lower edge of gill-opening and another across body and base of pectoral just posterior to gill-opening to origin of dorsal and anal and then extending on those fins to tips of produced rays.

Chætodon argenteus Linnæus, Amoen. Acad., IV, 249, 1759.

Psettus argenteus, Günther, Cat., II, 487.

Family APOGONICHTHYIDÆ.

89. *Amia frænata* (Valenciennes).

One specimen from Bacon (no. 3766; length 3.75 in.). (Not *A. frænatus* of Günther.)

Head 2.5 in length; depth 3.18; snout 4; eye very large, longer than snout, 3.1 in head; side with a well-defined black band about width of pupil, extending through eye and across tip of snout, where it is most distinct; a distinct black spot on caudal peduncle at base of caudal fin; a black bar on base of anal; anterior dorsal spines black.

From *Amia snyderi* this species seems to differ in the larger eye, more slender body, and better defined black caudal spot and lateral band. The two may, however, be identical.

Apogon frænatus Valenciennes, Nouv. Ann. Mus. Hist. Nat., 57, pl. 4, fig. 4, 1832.

90. *Amia koilomatodon* (Bleeker).

Two fine specimens from Bacon (no. 3509 and 3511; length 4.75 and 5.2 in.). These agree in every respect with specimens from Samoa.

Apogon koilomatodon Bleeker, Nat. Tijds. Ned. Ind., IV, 134, 1853, **Ternate**.

Amia koilomatodon Bleeker, Atlas, VII, pl. CCCLVII, fig. 1; Jordan & Seale, Bull. U. S. Bu. Fish., XXV, 1905 (1906), 240, fig. 34.

91. *Amia quadrifasciata* (Cuvier & Valenciennes). *Bakutut*.

Twenty-nine specimens from Jolo (no. 3555 to 3583; length 2.5 to 3.5 in.), all showing the indistinct vertical bands, in addition to the 2 distinct longitudinal stripes; no caudal spot, the lower longitudinal stripe extending to tip of caudal.

Apogon quadrifasciatus Cuvier & Valenciennes, Hist. Nat. Poiss., II, 113 (153), 1828, **Pondicherry**; Günther, Cat., I, 239; Day, Fishes India, 59.

Amia quadrifasciata, Bleeker Atlas, VIII, 88, pl. CCCXXXV, fig. 1.

92. *Amia fasciata* (Quoy & Gaimard).

Four specimens from Bacon (no. 5752; length 1.25 to 1.5 in.), similar in every respect to a specimen from Samoa. The upper and lower bands converge on the caudal fin, touching or nearly so, the median band near tip of tail.

The type of *Apogon fasciatus* Quoy & Gaimard, came from Guam and the same specimen appears to have been used by Cuvier & Valenciennes as one of the types of their *Apogon novemfasciatus* published five years later. The other specimen in the possession of Cuvier & Valenciennes came from Timor and, according to a recent note from Mr. Vaillant, appears to be the same species.

Apogon fasciatus Quoy & Gaimard, Voy. Uranie, Zool., 344, 1824, Guam (type in Paris Mus.).

Apogon novemfasciatus Cuvier & Valenciennes, Hist. Nat. Poiss., II, 114 (154), 1829, in part; Guam specimen.

Apogon fasciatus, Day, Fishes India, 60, in part; not of White.

93. *Amia chrysopoma* (Bleeker).

Two specimens from Bacon (no. 3976 and 3365; length 3.1 and 4 in.).

Head 2.85 in length; depth 2.85; eye 2.75 in head; dorsal VII-I, 9; anal II, 8; scales 2-29-6; posterior limb of preopercle serrate, anterior limb entire; maxillary extending to below middle of eye; gillrakers 20 on lower limb.

These specimens agree with Bleeker's description, except that the color in spirits is slightly different. They are yellowish with 2 very indistinct dusky longitudinal lines, the lower one being on the median line, and easily overlooked; a black caudal spot just above lateral line, 5 pearl-colored spots on opercle; anterior of spinous dorsal dusky; other fins immaculate.

Apogon chrysopomus Bleeker, Nat. Tijds. Ned. Ind., VII, 1854, 239, Macassar.

Amia chrysopomus Bleeker, Atlas, VII, 86, and Atlas, VIII, pl. CCCXLIX, fig. 1.

Apogon chrysopomus, Günther Cat., I, 240.

94. *Amia hartzfeldi* Bleeker.

Nine specimens from Bacon (no. 2899, 4194, 4195, 4196 and 3810 to 3814; length 3.2 to 4 in.).

These seem in every respect similar to specimens from Cavite, and agree entirely with Bleeker's colored plate of this species.

Amia hartzfeldi Bleeker Nat. Tijds. Ned. Ind., III, 254, 1852, Amboyna.

Apogon hartzfeldii, Günther, Cat., I, 242.

95. *Amia savayensis* (Günther).

Six specimens from Bacon (no. 3510, 3880 to 3883 and 3885; length 2.75 to 3.75 in.), all having the dark saddle over caudal peduncle, dark upper and lower margin to caudal, and a more or less distinct dusky line from eye to angle of preopercle; anterior spines of spinous dorsal dusky; anterior rays and tip of soft dorsal dusky; only two specimens show traces of vertical bands seen on some Samoan specimens.

Apogon savayensis Günther, Proc. Zool. Soc. Lond. 1871, 656, Savaii, Samoa; Fische der Sudsee, 21. pl. 19, fig. B (Samoa; Tonga; Yap; Tahiti).

96. *Amia sangiensis* (Bleeker).

One specimen from Bulan (no. 3889; length 3 in.). The dorsal formula is VII-I, 9, instead of VI-I, 8 or 9, as given, the first spine being very minute and easily overlooked.

Apogon sangiensis Bleeker, Nat. Tijds. Ned. Ind., XIII, 1857, 375, Sangi; Günther, Cat., I, 235 (Sea of Sangi).

Amia sangiensis Bleeker Atlas, VII, 95, pl. CCCXIX, fig. 4.

97. *Amia monochrous* (Bleeker).

Two specimens in poor condition from Bulan (no. 4015 and 4016; length 3.5 and 3.75 in.).

Apogon monochrous Bleeker, Manado en Macassar, 34, Act. Soc. Sci. Ind. Ned., 1856, Manado; Günther, Cat., I, 236.

98. *Amia novæ-guinæ* (Valenciennes).

Five specimens from Bulan (no. 4007 and 4013; length 2.1 to 2.56).

Apogon novæ-guinæ Valenciennes, Nouv. Ann. Mus. Hist. Nat., 53, pl. 4, 1832, New Guinea; Günther, Cat., I, 237.

99. *Amia jenkinsi* Evermann & Seale, new species.

Head 2.75 in length; depth 2.9; eye 3 in head; snout 4.6; interorbital 4.2, dorsal VII-1, 9; anal II, 8; scales 3-25-5.

Body oblong, moderately compressed; depth of caudal peduncle 2.4 in head; anterior profile from base of dorsal to tip of snout forming a straight line at an angle of about 15°; mouth large; lower jaw the longer; maxillary 2.1 in head, its posterior margin under middle of pupil, the width of distal end equal to pupil; mandible 1.75 in head; minute teeth on jaws, vomer, and palatines in 1 or 2 rows; 16 gillrakers on lower limb, the longest about 7 in head; posterior limb of preopercle finely denticulate, a few scattered denticulations at angle of anterior limb; opercle with an indistinct spine on posterior margin; body entirely covered with large weakly ctenoid scales; lateral line complete; 2 rows of scales on cheek; origin of spinous dorsal midway between tip of snout and posterior axil of soft dorsal, the longest spine 2.1 in head; longest ray of soft dorsal 1.75 in head; origin of anal under middle of soft dorsal, its base 2.25 in head, longest ray 2 in head; origin of

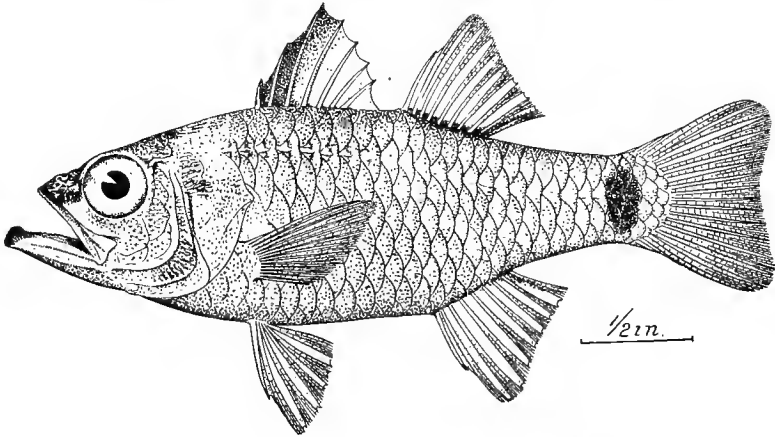

FIG. 9.—*Amia jenkinsi* Evermann & Seale, new species. Type.

ventrals under base of pectoral, their length 1.75 in head; pectoral 1.5 in head; caudal rounded, 1.5 in head.

Color in spirits, dull yellowish, shaded with minute brown punctulations, a large quadrate black spot on middle of base of caudal; a round jet-black spot about size of pupil on each side of nuchal region; a wide distinct black line on side of snout from eye to mouth; tip of lower jaw black; spinous dorsal black; a shading of dusky on base of soft dorsal and anal, otherwise fins all yellowish. One specimen, the type, no. 55907, U. S. National Museum (field no. 4036), length 3.4 in., from Bulan, Sorsogon, P. I.

Named for Dr. O. P. Jenkins, of Stanford University.

100. *Amia endekataenia* (Bleeker).

Three specimens from Bacon (no. 3839 and 3818; length 2.25 to 3.5 in.).

A. endekataenia is undoubtedly a species distinct from *A. fasciata*, easily distinguished by the bluntly rounded profile of the head, the short snout, and the more rounded preopercle. Gillrakers 11 on lower limb (including nodules); only posterior limb of preopercle serrated. Our specimens are faded, but the 4 dusky longitudinal lines are quite perceptible in the large specimen; also the rather diffused dusky caudal spot. The small specimens have the spinous dorsal tipped with dusky and show indistinct traces of dusky vertical lines, as in *A. quadrifasciata*; the large specimen has ventrals tipped with dusky.

Apogon endekataenia Bleeker, Nat. Tijds. Ned. Ind., III, 1852, 449, **Banka**.

Amia endekataenia Bleeker Atlas, VII, 85, pl. CCCX, fig. 2.

101. *Amia margaritophora* (Bleeker).

One specimen from Bacon (no. 4197; length 1.75 in.).

Head 2.75 in length; depth 2.9; eye 3 in head; dorsal vi-i, 9; anal ii, 8; scales 3-25-7; teeth on palatines and vomer.

Apogon margaritophorus Bleeker, Nat. Tijds. Ned. Ind., vii, 1854, 363, Batjan.

Amia margaritophorus Bleeker, Atlas, vii, 91, pl. cccc, fig. 4; Günther, Cat., i, 234.

102. *Apogonichthys mentalis* Evermann & Seale, new species.

Head 2.75 in length; depth 3.4; eye 3.1 in head; snout 4; interorbital equal to snout; dorsal vi-i, 10; anal ii, 12 (the small anterior anal spine broken off in type); scales probably about 28, deciduous.

Body oblong, moderately compressed; depth of caudal peduncle 3.2 in head; mouth large, the lower jaw the longer; maxillary 2.5 in head, its distal end under anterior margin of pupil; mandible 2.15 in head; minute teeth in jaws, none on vomer or palatines; 20 gillrakers on lower limb, the longest equal to pupil; no denticulations on preopercle; opercle with a single point; entire body covered with thin, very deciduous cycloid scales; lateral line probably complete, apparently a single row of scales on cheek; origin of spinous dorsal midway between tip of snout and axil of soft dorsal; longest dorsal spine 2.5 in head; base of soft dorsal

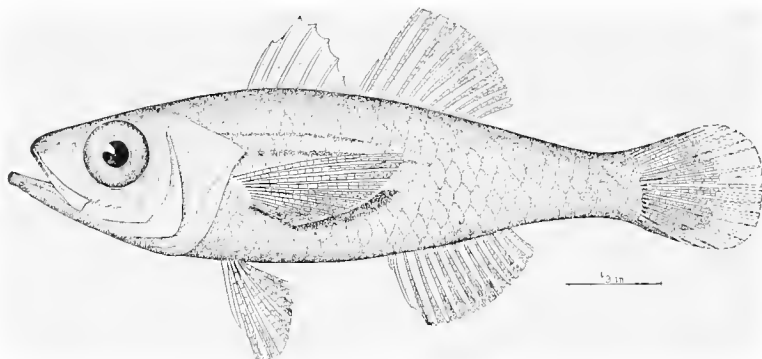

FIG. 10.—*Apogonichthys mentalis* Evermann & Seale, new species. Type.

1.75 in head, its longest ray 2 in head; origin of anal under anterior third of soft dorsal, its longest ray 2.75 in head, its base 1.75; ventrals below base of pectoral, their length 2.1 in head; pectoral 1.3, the tip reaching beyond anal spines; caudal rounded.

Color in spirits, yellowish white; 2 black longitudinal lines separated by pale yellow on side to below posterior end of soft dorsal; some dark dots on opercle, a shading of dusky at tip of snout and on tip of lower jaw; fins all uniform yellowish white.

Two specimens, the type, no. 55905, U. S. National Museum (B. F. no. 3772, field no. 10696), a female full of mature eggs, and cotype no. 20002, Stanford University, each about 2.5 inches long, from Bacon, Sorogon, P. I.; collector Charles J. Pierson.

103. *Archamia macropteroides* (Bleeker).

Thirty-eight specimens from Bacon (no. 3896, 3867, 3991, and 3884; length about 3 in.).

Head 2.75 in length; depth 2.45; eye 3 in head; snout 5.5; dorsal vi-i, 10; anal ii, 17; scales 4-27-9.

Color in spirits, dirty yellowish, the body and head thickly punctulate with blackish; a large black spot at base of caudal and a similar but smaller one on shoulder, these both very distinct.

Our specimens differ from those from Samoa, which Jordan & Seale identified with *A. lineolata* (Ehrenberg) in having the body deeper, the eye larger, the head blunter, and the shoulder spot always distinct. *A. bleekeri* differs from the present species in the shape of the caudal spot and the more anterior position of the shoulder spot.

Apogon macropteroides Bleeker, Nat. Tijds. Ned. Ind., iii, 1852, 724, Lepar Island, Banka; Günther, Cat., i, 245.

104. *Archamia bleekeri* (Günther). *Masanqui*.

Forty-eight specimens from Bacon (no. 3279 to 3306 and 3678; length 1.5 to 3 in.), and 2 from San Fabian (no. 3815; length 1.25 in.).

These each have 16 anal rays, a round black spot at base of caudal, its outline sharply defined, a large black spot at anterior end of lateral line, touching upper edge of opercle, and a dusky line from eye to subopercle. Resembling *A. macropteroideus* but readily distinguished by the form and position of the caudal and humeral spots.

Among our specimens are both males and females. Nearly mature eggs were found in the ovaries of some of the females, and a mass of mature eggs was discovered in the mouth of a male. It has long been asserted that the male of certain species of this family carries the eggs in his mouth during incubation. Measurements of 10 of these eggs gave an average diameter of 0.51 mm.

Apogon bleekeri Günther, Cat., I, 245, 1859, **Batavia; Padang; Amboyna.**

Apogon macropterus. Bleeker, Nat. Tijds. Ned. Ind., II, 168, 1851, and Atlas, VIII, pl. cccxlvI, fig. 2.

Family AMBASSIDÆ.**105. *Ambassis urotænia* Bleeker.**

One hundred and three specimens from Bacon (no. 3408 and 3621; length 1.75 to 3 in.).

Head 2.75 in length; depth 2.75; eye 3.1 in head; snout 4.75; second dorsal spine 4 in length; dorsal VII-I, 9; anal III, 10; scales 4-28-6, 2 rows on cheek.

Ambassis urotænia Bleeker, Nat. Tijds. Ned. Ind., III, 1852, 257, **Amboyna**; Atlas, VIII, 135, pl. cccxlvI, fig. 2, and pl. cccLI, fig. 1; Günther, Cat., I, 224.

106. *Ambassis lungi* (Jordan & Seale).

Four specimens from Bacon (no. 3834 and 4192; length 1 to 3 in.).

This species is easily distinguished by the single row of scales on cheek, the broken lateral line, and the color of the fins and back.

Ambassis urotænia, Day, Fishes India, pl. xv, fig. 8; not of Bleeker.

Priopis lungi Jordan & Seale, Bull. Bu. Fisheries, xxvi, 1906, 18, fig. 6, **Cavite, Luzon.**

Family PEMPHERIDÆ.**107. *Pempheris vanicolensis* Cuvier & Valenciennes.**

Eight specimens from Bacon (no. 3213 to 3218, 3542 and 3762; length 3.75 to 6 in.), and 3 young from Bulan (no. 3817).

Head 3.4 in length; depth 2.2; eye 2.6 in head; snout 6.5; anal III, 43.

No black spot on base of pectoral; anterior dorsal rays black-tipped; edge of anal black. These characters distinguish the species.

Pempheris vanicolensis Cuvier & Valenciennes, Hist. Nat. Poiss., VII, 227 (305), 1831, **Vanicolo.**

Family SERRANIDÆ.**108. *Epinephelus merra* Bloch.**

Four specimens from Bacon (no. 3630, 3631, 3632, and 4082; length 4 to 6.5 in.).

Epinephelus merra Bloch, Ichth., VII, 17, pl. cccxxI, 1797; Boulenger, Cat., I, 241, 1895.

109. *Epinephelus tauvina* (Forskål).

One specimen from Bacon (no. 3633; length 1.4 in.).

Perca tauvina Forskål, Deser. Anim., 39, 1775, **Red Sea.**

Epinephelus tauvina, Boulenger, Cat., I, 244.

110. *Epinephelus fasciatus* (Forskål).

One fine specimen from Bacon (no. 4040; length 10.75 in.).

Perca fasciata Forskål, Deser. Anim., 40, 1775, **Red Sea.**

Epinephelus fasciatus, Boulenger, Cat., I, 238.

111. *Epinephelus maculatus* (Bloch).

Two fine specimens from San Fabian (no. 3224 and 3225; length 4.5 and 8.5 in.).

Holocentrus maculatus Bloch, Ichth., IV, 96, pl. CXXII, fig. 3, 1797.

Epinephelus maculatus, Boulenger, Cat., I, 211.

112. *Cephalopholis pachycentron* (Cuvier & Valenciennes).

Three specimens from Bacon (no. 3385, 3386, and 3850; length 5.5 to 5.75 in.).

Dorsal IX, 15; anal III, 8; scales 80. The specimens are without light margin to fins and the ventrals extend to vent; otherwise they agree with the descriptions.

Serranus pachycentron Cuvier & Valenciennes, Hist. Nat. Poiss., II, 219 (295), 1828 (type no. 7432, Paris Museum).

Epinephelus pachycentrum, Boulenger, Cat., I, 178.

113. *Cephalopholis kendalli* Evermann & Seale, new species.

Head 2.66 in length; depth 2.85; eye 6.3 in head; snout 4.75; interorbital 7.5; maxillary 2.1, its distal end reaching beyond orbit, the distal width of maxillary 1.1 in orbit; dorsal IX, 16; anal III, 8; scales about 20-80-22, 45 pores.

Body oblong, moderately compressed; depth of caudal peduncle 3 in head; anterior profile evenly curved from origin of dorsal to snout, slightly concave before and behind eye; mouth large, lower jaw slightly pro-

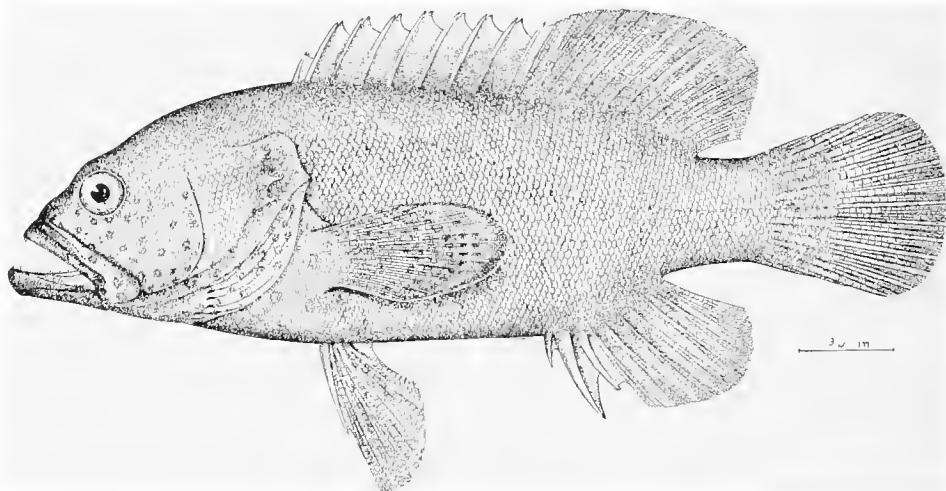

FIG. 11. — *Cephalopholis kendalli* Evermann & Seale, new species. Type

jecting; several bands of sharp teeth in each jaw with a single curved canine on each side anteriorly, the inner teeth largest and depressible; teeth on vomer and palatines; gillrakers sharp, their inner surface spinulose, 9 developed on lower limb, the longest 2 in orbit; margin of preopercle rounded, finely denticulate, the denticulations scarcely enlarged at angle; opercle with 3 distinct spines, the upper one more distant from center one and slightly more posterior than lower; opercular membrane very obtusely rounded, the upper margin concave.

Body covered with fine ctenoid scales; head and nuchal region with cycloid scales; maxillary scaled, the scales on nuchal region and top of head very fine, about 80 in series in front of dorsal; origin of dorsal above base of pectoral, the spines increasing in length posteriorly, the second spine 1.35 in ninth, the first 2.5 in ninth; rays of soft dorsal much longer than spines, the longest ray 2.5 in head; second anal spine longest, 3 in head; longest anal ray 2 in head; origin of anal nearer to base of caudal than to origin of ventrals; pectoral 1.5 in head, tip extending slightly posterior to vent, but not reaching a line with origin of anal fin; ventrals 2 in head, their origin midway between tip of snout and base of sixth anal ray, their tips reaching to, but not beyond, vent; caudal rounded, 1.75 in head.

Color in spirits, dark brown; large scattered blue spots with black margins on head, thorax, belly, and fins except spinous dorsal, which is dusky; no bars or spots on other portions of body, the spots on fins indistinct, except on pectoral, where they form rows; pectoral with a slight wash of yellowish with a black margin—otherwise the fins all blackish without a trace of lighter margins.

This species is related to *C. guttatus*, from which it differs in the larger scales, longer ventrals, smaller eye, and in coloration.

One fine specimen from Bacon, no. 55911, U. S. National Museum (B. F. no. 3722), length 7.5 in.; collector Charles J. Pierson.

We take pleasure in naming this species for our associate, Dr. Wm. C. Kendall, of the U. S. Bureau of Fisheries.

114. *Cephalopholis bænack* (Bloch).

One specimen from Bacon (no. 3856; length 5 in.).

Bodianus bænack Bloch, Ichth., IV, 31, pl. cccxvi, 1797.

Epinephelus bænack, Boulenger, Cat., I, 189.

115. *Cephalopholis obtusauris* Evermann & Seale, new species.

Head 2.55 in length; depth 2.8; eye 5.3 in head; snout 3.9; interorbital 1.75 in snout; dorsal IX, 15; anal III, 9; scales about 12–95–26, with 48 pores in lateral line.

Body oblong, moderately compressed; depth of caudal peduncle 2.95 in head; body and head covered with minute scales with rough margins; lateral line with a distinct curve above pectoral; head large; mouth very large; maxillary 2 in head, its distal end under middle of eye, its width 1.3 in eye; mandible 1.85; small

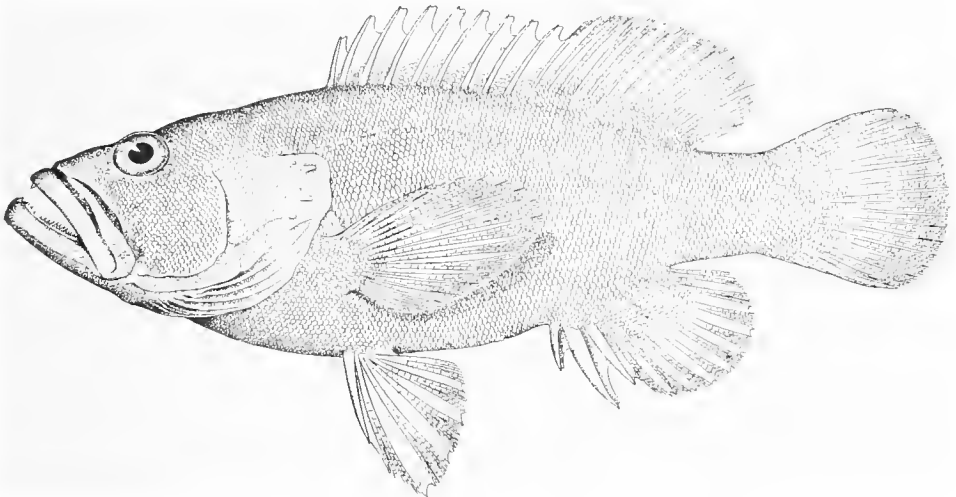

FIG. 12.—*Cephalopholis obtusauris* Evermann & Seale, new species. Type.

teeth on jaws, vomer, and palatines, outer series on upper jaw slightly enlarged, with 2 canines on each side anteriorly, and with some enlarged depressible teeth posterior to them; a canine on each side of symphysis of lower jaw, with a row of larger depressible teeth among the small ones on sides; 14 gillrakers on lower limb (counting knobs), the longest equal to pupil; preopercle slightly rough; opercle with 3 spines, the lower one a little anterior to the others, the upper one more removed from center one; opercular flap very obtusely rounded, not ending in a sharp point; origin of dorsal fin on a line with axil of pectoral, and midway between tip of snout and base of eighth dorsal ray; longest dorsal spine 3 in head, the anterior spine less than diameter of eye; longest dorsal ray 2.3 in head; origin of anal slightly nearer base of ventral than to base of caudal, and on a line with base of third dorsal ray; base of anal 2.4 in head, its longest ray 2 in head, the second anal spine the strongest and slightly the longest; ventrals 1.75 in head, their tips reaching a little past vent, but not to base of anal fin; pectoral 1.3 in head, the tip on a line with origin of anal fin; caudal rounded, 1.75 in head.

Color in spirits, uniform yellowish, with slight wash of dull brown, evidently uniform red in life; fins unmarked.

Related to *C. aurantius* Cuvier & Valenciennes, but with shorter premaxillary and obtuse flap to opercle, and fewer scales in lateral line.

One specimen, the type, no. 55910, U. S. National Museum (Bureau of Fisheries no. 3541; length 9.15 in.) from Bacon, Sorsogon, P. I.; collector Charles J. Pierson.

116. *Cromileptes altivelis* (Cuvier & Valenciennes).

One specimen from Bacon (no. 3763; length 3.75 in.).

Color in spirits, yellowish, the spots brown, large, and sparsely placed.

Serranus altivelis Cuvier & Valenciennes, Hist. Nat. Poiss., II, 241 (324), pl. 35, 1828, **Java**.

Cromileptes altivelis, Bleeker, Atlas, VII, 30, and Atlas, VIII, pl. CCCXXII, fig. 3; Boulenger, Cat., I, 271.

117. *Grammistes sexlineatus* (Thunberg).

One specimen from Bacon (no. 3750; length 3 in.).

Perca sexlineata Thunberg, K. Vetensk. Acad. n. Handl., XIII, 1792, 142, pl. v, no locality.
Grammistes sexlineatus, Boulenger, Cat., I, 346.

118. *Psammoperca waigiensis* (Cuvier & Valenciennes).

One small specimen from Bulan (no. 3759; length 1.85 in.).

Labrax waigiensis Cuvier & Valenciennes, Hist. Nat. Poiss., II, 61 (83), 1828, **Waigiou**.

Psammoperca waigiensis, Bleeker, Atlas, VII, 108, pl. CCCVI, fig. 2.

Psammoperca waigiensis, Boulenger, Cat., I, 365 (Cebu).

119. *Plectropoma calcariferum* (Bloch). *Mulmul*.

One specimen from Zamboanga (no. 4065; length 13.5 in.).

Holocentrus calcarifer Bloch, Ichth., IV, 80, pl. CCXLIV, 1797, **Japan**.

Lates calcarifer, Day, Fishes India, 7, pl. 1, fig. 1; Boulenger, Cat., I, 363.

120. *Pharopteryx nigricans* Rüppell.

One specimen from Bacon (no. 3837; length 1.5 in.).

Pharopteryx nigricans Rüppell, Atlas, Fische, 15, pl. IV, fig. 2, 1828, **Red Sea**.

Plesiops nigricans, Günther, Cat., III, 363; Boulenger, Cat., I, 340.

Family PRIACANTHIDÆ.

121. *Priacanthus hamrur* (Forskål).

One specimen from Bulan (no. 3267; length 7.5 in.).

Head 3 in length; depth 2.75; eye 2.56 in head; snout 3; interorbital 3.75; gillrakers 15 on lower limb of first arch; preopercular spine 2 in pupil; tenth dorsal spine 2.5 in head, or 1.7 times length of second; longest soft rays of dorsal a third longer than longest spine; pectoral 1.9 in head; ventrals 1.1, the spine 1.5; third anal longer than sixth dorsal spine, nearly equal to tenth; dorsal spines smooth, the anal and ventrals spinulose.

Ventrals black on distal third and a black spot in axil; dorsal and anal margined with black.

Boulenger gives the number of gillrakers on lower limb of first arch as 18 to 23. Our specimen has 15. This range is great and may represent 2 or more species.

Sciæna hamrur Forskål, Deser. Anim., 45, 1775, **Red Sea**.

Priacanthus hamrur, Boulenger, Cat., I, 355.

Family LUTIANIDÆ.

122. *DiaCOPE sebæ* Cuvier & Valenciennes.

Three fine specimens from Bulan (no. 4072 to 4074; length 4.75 to 5.25 in.).

DiaCOPE sebæ Cuvier & Valenciennes, Hist. Nat. Poiss., II, 310 (411), 1828, **Waigiou**.

Lutianus sebæ, Day, Fishes India, 30, pl. IX, fig. 3.

123. *Lutianus quinquelineatus* (Bloch).

Five specimens from Bulan (no. 3535, 3311, 3272, 3273, and 3248; length 6 to 6.5 in.), and one from Bacon (no. 3312; length 6.5 in.).

Easily distinguished by the 5 blue stripes along side and the large black blotch under beginning of soft dorsal.

Holocentrus quinquelineatus Bloch, Ichth., IV, 84, tab. cccxxxix, 1797.

Mesoprion quinquelineatus, Cuvier & Valenciennes, Hist. Nat. Poiss., II, 336 (442) (Java); Günther, Cat., I, 209.

Lutianus quinquelineatus, Day, Fishes India, 40, pl. XII, fig. 3; Bleeker, Atlas, VIII, 56, pl. cccxliii, fig. 4.

124. *Lutianus decussatus* (Kuhl & Van Hasselt). *Buegang*.

Four specimens from Bacon (no. 3954 and 3264 to 3266; length 5.75 to 7 in.).

Easily distinguished by the 5 or 6 broad longitudinal brownish bands, the upper 3 crossed by short vertical bars, and a black spot on base of caudal.

Mesoprion decussatus Kuhl & Van Hasselt in Cuvier & Valenciennes, Hist. Nat. Poiss., II, 369 (487), 1828, Java; Günther, Cat., I, 210.

Lutianus decussatus, Day, Fishes India, 47, pl. XIV, fig. 4; Bleeker, Atlas, VIII, 72, pl. cccxxxviii, fig. 4.

125. *Lutianus monostigma* (Cuvier & Valenciennes).

One specimen from Bacon (no. 3640; length 6.5 in.). No teeth on tongue; dark spot on the lateral line smaller than in *L. johnii*, which has distinct teeth on tongue.

Mesoprion monostigma Cuvier & Valenciennes, Hist. Nat. Poiss., II, 337 (446), 1828, Seychelles.

Lutianus lioglossus Bleeker, Atlas, VIII, 70, pl. ccxcliv, fig. 4, Bintang, Java, Celebes, Amboyna.

126. *Lutianus fulviflamma* (Forskål). *Bitilla*.

One specimen from Bacon (no. 4168; length 10.25 in.), and 2 from Zamboanga (no. 3459 and 3443; length 6 and 7 in.).

Sciæna fulviflamma Forskål, Descr. Anim., 45, 1775, Red Sea.

Mesoprion fulviflamma, Günther, Cat., I, 201, in part.

Lutianus fulviflamma, Day, Fishes India, 41, pl. XII, fig. 6; Bleeker, Atlas, VIII, 65, pl. cccxcliv, fig. 3.

127. *Lutianus johnii* (Bloch). *Bitilla*: *Manila*.

Two specimens from Jolo (no. 4041 and 4042; length 8 and 10 in.), one from Bacon (no. 4166; length 10 in.), and 2 from Bulan (no. 3539 and 3540; length 5.5 and 6.2 in.).

Readily distinguished by its having the rows of scales parallel with the back; teeth on tongue.

Anthias johnii Bloch, Ichth., IX, 97, pl. cccxviii, 1797.

Mesoprion johnii, Günther, Cat., I, 200.

Lutianus johnii, Bleeker, Atlas, VIII, 49, pl. cccxxxviii, fig. 3; Day, Fishes India, 42, pl. XIII, fig. 1.

128. *Lutianus luzonius* Evermann & Seale, new species.

Head 2.55 in length; depth 2.55; eye 4 in head; snout 3.1; interorbital 4.8; dorsal x, 14; anal III, 8; scales 7-48-16; teeth on tongue.

Body oblong, moderately elevated and compressed; dorsal surface evenly curved; depth of caudal peduncle 3.18 in head; jaws equal; maxillary scarcely reaching anterior margin of pupil, its length 2.55 in head; greatest width of premaxillary not more than 2 in pupil; mandible 2.5 in head; preorbital 1.75 in eye; teeth on jaws, vomer, palatines, and tongue, those of jaws in a single series, small, canine-shaped, the anterior ones of upper jaw enlarged; gillrakers 11 on lower limb, the longest about equal to pupil; notch of preopercle very deep and distinct, the lower limb slightly produced backward, rounded, and rather strongly toothed; knob of interopercle large and strong; opercle ending in a single sharp point; origin of dorsal slightly anterior to origin of pectoral, the distance between tip of snout and first dorsal spine scarcely greater than length of head, longest spine 2.7 in head, longest soft ray 3.5; origin of anal midway between origin of ventrals and base of caudal, its base 3.75 in base of dorsal, the longest ray 2.75 in head, the second spine longest and strongest, 2.5 in head; ventrals 1.75 in head, their tips reaching vent; pectoral 1.24, the tip scarcely reaching line with origin of anal; caudal emarginate, 1.3 in head.

Color in spirits, dull yellowish white, with a round black spot about size of eye entirely above lateral line under anterior part of soft dorsal; scales with slightly darker centers, giving an appearance of fine indistinct oblique dusky lines above lateral line and longitudinal ones below; a distinct black spot occupying upper base and axil of pectoral; fins uniform, without marking.

Three fine specimens from Bacon (no. 3229, 3230, 3675; length 5.75 to 6.8 in.). This species is related to *L. russelli* (Bleeker), from which it appears to differ in the deeper preopercular notch, the strong interopercular knob, the long pectoral fin, and in coloration.

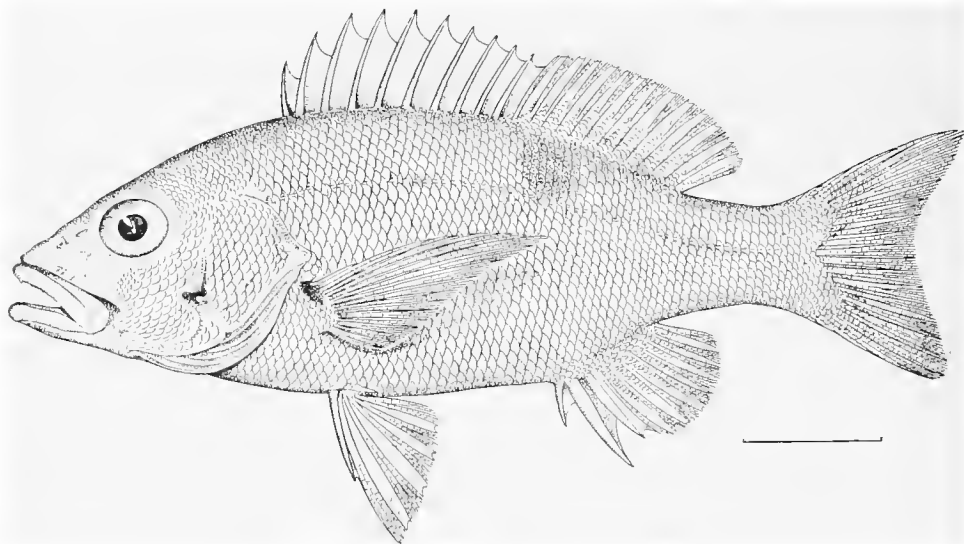

FIG. 13.—*Lutianus lunulatus* Evermann & Seale, new species. Type.

Type, no. 55918, U. S. National Museum (original no. 3230), a specimen 6.8 inches long, from Bacon, Sorsogon, P. I.; collector Charles J. Pierson. Cotypes, no. 4539, Bureau of Fisheries, and no. 20003, Stanford University.

129. *Lutianus furvicaudatus* Fowler.

One specimen from Bacon (no. 3785; length 8.5 in.). This species is distinguished from *L. lunulatus* by the shorter maxillary and scarcely perceptible lingual teeth. We have examined Mr. Fowler's type.

Lutianus furvicaudatus Fowler, Journ. Acad. Nat. Sci. Phila., 2d ser., vol. XII, 1904 (June 10), 525, pl. XVIII, lower fig., Padang. (Type, 7½ in. long, no. 27596, Phila. Acad. Nat. Sci.).

130. *Lutianus gibbus* (Forskål).

One specimen from Bacon (no. 4035; length 5 in.).

Sciæna gibba Forskål, Deser. Anim., 46, 1775, Red Sea.

Genyroroge gibba, Günther, Cat., I, 180.

Mesoprion gibbus, Günther, Fische der Südsee, 12, taf. 12, 13 (fig. A).

131. *Lutianus erythropterus* Bloch.

One specimen from San Fabian (no. 3343; length 5.8 in.).

Lutianus erythropterus Bloch, Ichth., VII, 93, pl. CCXLIX, 1797, Japan; Day, Fishes India, 32, pl. x, figs. 1 and 2; not of Bleeker. *Mesoprion erythropterus*, Günther, Cat., I, 205.

132. *Lutianus lunulatus* (Mungo Park).

Five specimens from Bacon (no. 3309, 3310, and 4135 to 4137; length 6.5 to 7.5 in.), and one from Bulan (no. 3517; length 7 in.).

Perca lunulata Mungo Park, Trans. Linn. Soc. Lond., III, 1797, 35, pl. 6, Sumatra.

Lutianus lunulatus, Bleeker, Atlas, VII, pl. CCXCV, fig. 1, and Atlas, VIII, 66 (Sumatra; Celebes).

133. *Lutianus vitta* (Quoy & Gaimard). *Bitilla*.

Two specimens from Bacon (no. 3718 and 3719; length 5.75 and 6.1 in.), one from Bulan (no. 3595; length 5 in.), and one from Zamboanga (no. 4096; length 9 in.).

Serranus vitta Quoy & Gaimard, Voy. Uranie, 315, pl. 58, fig. 3, 1824, **Waigiou**.

Diacope vitta Temminck & Schlegel, Fauna Japonica, Pisces, 13, pl. vi, fig. 1.

Lutianus vitta, Day, Fishes India, 46, pl. xiv, fig. 2.

134. *Lutianus lineatus* (Quoy & Gaimard). *Alangot*.

One specimen from San Fabian (no. 4125; length 7.5 in.). This specimen is abnormal, in that it has but 9 dorsal spines; teeth on tongue.

Diacope lineato Quoy & Gaimard, Voy. Uranie, Zool., 309, 1824, **Rawak et Waigiou**.

Mesoprion lineatus, Günther, Cat., 1, 193.

Lutjanus lineatus, Bleeker, Atlas, vii, pl. ccciv, fig. 4, and Atlas, viii, 69 (East Indies).

135. *Lutianus amboinensis* (Bleeker).

One specimen from Bulan (no. 3226; length 6.95 in.). Dorsal with 11 spines; no teeth on tongue.

Mesoprion amboinensis Bleeker, Nat. Tijds. Ned. Ind., iii, 1852, 259, **Amboyna**.

Lutjanus amboinensis Bleeker, Atlas, vii, pl. cccxviii, fig. 2, and Atlas, viii, 57 (East Indies).

Genyoroge amboinensis, Günther, Cat., 1, 183 (Amboyna).

136. *Lutianus lineolatus* (Rüppell).

Four specimens from Bacon (no. 3358, 3359, 3361, and 3362; length 6 to 6.5 in.), and 6 from Bulan (no. 3245 to 3247, 3605, and 3596; length 5.75 to 6.1 in.).

Diacope lineolata Rüppell, Atlas, Fische, 76, pl. 19, fig. 3, 1828, **Massaua**; not of Bleeker.

Mesoprion lineolatus, Günther, Cat., 1, 205.

Lutianus lineolatus, Day, Fishes India, 35, pl. xi, figs. 1 and 2.

137. *Lutianus malabaricus* (Bloch & Schneider).

One small specimen (no. 4006; length 1.75 in.), from Bulan, probably the young of this species.

Sparus malabaricus Bloch & Schneider, Syst. Ichth., 278, 1801, "in mari Indico."

Lutianus malabaricus, Day, Fishes India, 31, pl. ix, fig. 4.

138. *Gymnocranius lethrinoides* (Bleeker).

Three specimens from Bulan (no. 4046 to 4048; length 4.5 to 6 in.).

Dentex lethrinoides Bleeker, Sparoiden, 11, Verh. Bat. Gen., xxiii, 1850, **Batavia**.

Gymnocranius lethrinoides Bleeker, Atlas, viii, 96, pl. cccxxxii, fig. 1, and pl. cccxxxiv, fig. 3.

139. *Pinjalo typus* (Bleeker).

One specimen from San Fabian (no. 3344; length 6.5 in.), and one from Bulan (no. 4038; length 11.5 in.).

Cæzio typus Bleeker, Marnoiden, 10, Verh. Bat. Gen., xxiii, 1850, **Batavia**; Day, Fishes India, 94, pl. xxiv, fig. 4; Günther, Cat., 1, 391; Bleeker, Atlas, vii, pl. ccxciii, fig. 3, and Atlas, viii, 33.

140. *Nemipterus nemurus* (Bleeker). *Pukit*.

Two specimens from Jolo (no. 3748 and 3778; length, with caudal filament, 12.5 and 13.5 in.).

Dentex nemurus Bleeker, Amboina, 49; Act. Soc. Sci. Ind. Neerl., ii, 1857; Atlas, viii, 87, pl. cccxxxv, fig. 4, **Amboyna**.

Synagris nemurus, Günther, Cat., 1, 378.

141. *Nemipterus worcesteri* Evermann & Seale, new species.

Head 3.45 in length; depth 3.75; eye 3.75 in head; snout 2.5; interorbital 1.9 in snout; dorsal x, 9; anal 9; scales 4-48-11.

Body oblong, moderately compressed; depth of caudal peduncle 3.35 in head; anterior profile of head not evenly rounded, being somewhat convex in front of eye; mouth rather large, the lower jaw slightly the longer;

maxillary 2.85 in head; mandible 3; distal end of maxillary not reaching to below anterior border of eye; preorbital 3.75; bands of small teeth in jaws, with small canines anteriorly, and a row of slightly enlarged curved teeth in each side; gillrakers represented by wide blunt knobs, 7 on lower limb; body covered by thin delicate scales, 3 rows on cheek; preopercle entire; opercle with a single spine at posterior margin; origin of dorsal on line with origin of pectoral, longest dorsal spine 2.1 in head, the longest ray 2.5; webs of dorsal fin scarcely incised; origin of anal slightly nearer origin of ventral than base of caudal, its longest ray 3.25 in head; base of anal 2.95 in base of dorsal; ventrals 1.4 in head, their origin below pectoral, their tips not reaching vent; pectoral 1.45 in head; caudal forked; none of the fins with elongate rays.

Color in spirits, yellowish white with slight tint of brown above; no stripes; a wide deep black band entirely encircling caudal peduncle, the black extending out slightly on upper and lower rays of caudal.

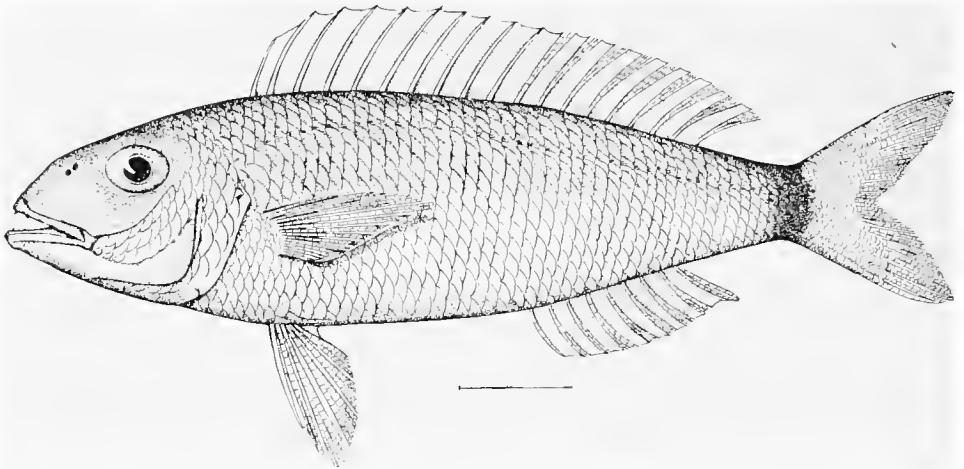

FIG. 14.—*Nemipterus worcesteri* Evermann & Seale, new species. Type.

One specimen (no. 4124; length 8.5 in.), from Bacon, Sorsogon, P. I., type no. 55917, U. S. National Museum; collector Charles J. Pierson.

We take pleasure in naming this species for the Hon. Dean C. Worcester, of the Philippine Commission, in recognition of his valuable work in promoting the study of the zoology of the Philippine Islands.

142. *Nemipterus tæniopterus* (Cuvier & Valenciennes). *Baga*.

One specimen from San Fabian (no. 3512; length 8 in.).

Dentex tæniopterus Cuvier & Valenciennes, Hist. Nat. Poiss., VI, 183 (246), locality unknown.
Synagris tæniopterus, Günther, Cat., I, 374 (N. E. coast of Australia; Molucca Sea).

143. *Nemipterus japonicus* (Bloch).

One specimen from San Fabian (no. 3436; length 7.5 in.).

Sparus japonicus Bloch, Ichth., pl. cclxxvii, fig. 1.
Dentex blochi Bleeker, Nat. Tijds. Ned. Ind., II, 1851, 176, Batavia; Atlas, VIII, 90, pl. cccxxx, fig. 4.
Synagris japonicus, Günther, Cat., I, 378; Day, Fishes India, 92, pl. xxiv, fig. 2.

144. *Nemipterus ovenii* (Bleeker).

Two specimens from Bulan (no. 3371 and 3372; length 6.25 and 7.5 in.).

Dentex ovenii Bleeker, Nat. Tijds. Ned. Ind., VII, 1854, 246, Celebes; Atlas, VIII, 86, pl. cccxxviii, fig. 5.
Synagris ovenii, Günther, Cat., I, 375.

145. *Cæsius cuning* (Bloch).

Fifteen specimens from Bacon (no. 3624 to 3636, 3400 to 3402, 3641, 3642, 3654 to 3657, 3486 to 3488, 4044 and 4045; length 4.75 to 10 in.) and one from Zamboanga (no. 4043; length 10 in.).

Sparus cuning Bloch, Ichth., pl. CCLXIII, fig. 1.

Cæsius cuning, Day, Fishes India, 95.

146. *Cæsius cæruleaurens* (Lacépède). *Sulik*.

Eighteen specimens from Bacon (no. 3481 to 3485, 3543 to 3548, 3473, 3474, 3985, and 4114 to 4117; length 4.75 to 8 in.), one from Zamboanga (no. 3419), and one from San Fabian (no. 3708).

Cæsius cæruleaurens Lacépède, Hist. Nat. Poiss., III, 86, 1829. Günther, Cat., I, 392; Bleeker, Atlas, VIII, 39, pl. CCCXLVII, fig. 4.

147. *Cæsius chrysozona* Kuhl & Van Hasselt.

Ten specimens from Bacon (no. 3702 to 3707, 4010, 4011, 3930, and 3931; length 5 to 6 in.).

Cæsius chrysozona Kuhl & Van Hasselt in Cuvier & Valenciennes, Hist. Nat. Poiss., VI, 331 (440) **Indian Archipelago**; Günther Cat., I, 392; Day, Fishes India, 95, pl. XXIV, fig. 5.

Family HÆMULIDÆ.**148. *Terapon jarbua* (Forskål). *Bungao*; *Siran banlaanon*; *Belaque*.**

Two specimens from Bulan (no. 4104 and 4105; length 5 and 7 in.) and 3 from San Fabian (no. 3261, 3265, and 4145; length 4 to 7 in.).

Scizna jarbua Forskål, Descr. Anim., 50, 1775. **Red Sea.**

Terapon scrius, Günther, Cat., I, 278.

Terapon jarbua, Day, Fishes of India, 69, pl. XVIII, fig. 4.

149. *Terapon puta* Cuvier & Valenciennes. *Dacosan*.

Twenty specimens from Bulan (no. 3695; length 2.1 to 2.75 in.), 60 from Bacon (no. 3701; length 2 to 2.45 in.), and 2 from San Fabian (no. 3738 and 3838; length 4.75 and 5.1 in.).

Terapon puta Cuvier & Valenciennes, Hist. Nat. Poiss., III, 98 (131) **East Indies**; Day, Fishes India, 68, pl. XVIII, fig. 3.

Terapon ghebul Ehrenberg in Cuvier & Valenciennes, Hist. Nat. Poiss., III, 99 (133); Günther, Cat., I, 281.

Terapon trivittatus, Günther Cat., I, 280.

150. *Terapon quadrilineatus* (Bloch). *Dacosan*; *Aguar*.

Twenty specimens from Bulan (no. 4198 and 3708; length 2.1 to 2.75 in.) and 2 specimens from San Fabian, (no. 3827 and 3975; length 5.75 in.). Ventrals reaching vent.

Holocentrus quadrilineatus Bloch, Ichth., VII, 63, pl. CCXXXVIII, fig. 2, 1797, **no locality.**

Terapon quadrilineatus, Günther, Cat., I, 282; Day, Fishes India, 70, pl. XVIII, fig. 5.

151. *Terapon theraps* (Cuvier & Valenciennes).

Five specimens from Bulan (no. 4200; length 2.1 in.) and 1 from Bacon (no. 4199; length 2.75 in.). In this species the ventrals do not reach the vent, which is located midway between base of caudal and origin of ventrals. In *T. quadrilineatus* the ventrals reach the vent, which is located much nearer to origin of ventrals than to base of caudal.

Terapon theraps Cuvier & Valenciennes, Hist. Nat. Poiss., III, 97 (129), pl. 53; Günther, Cat., I, 274; Day, Fishes India, 70, pl. XVIII, fig. 6.

152. *Pomadasis maculatus* (Bloch). *Lacsagu*.

Four specimens from San Fabian (no. 3334, 3335, 3337, and 3338; length 6 to 7 in.).

Anthias maculatus Bloch, Ichth., X, 7, pl. CCCXXVI, fig. 2, 1797, **East Indies.**

Pristipoma maculatum, Günther, Cat., I, 293 (Torres Strait; Amboyna); Bleeker, Atlas, VII, pl. CCCVIII, fig. 2.

Pomadasis maculatus, Bleeker, Atlas, VIII, 27.

153. *Pentapus caninus* (Cuvier & Valenciennes).

Three specimens from Bacon (no. 3935, 3936, and 3847; length 4.9 to 5.5 in.). Head 3.5 in length; depth 3.6; scales 3-44-12: dorsal x, 9; anal iii, 7.

Scolopsides caninus Cuvier & Valenciennes, Hist. Nat. Poiss., v, 266 (354), New Guinea.

Scolopsis caninus, Günther, Cat., i, 364.

Pentapus bifasciatus Bleeker, Atlas, vii, 103, pl. ccxcv, fig. 5.

154. *Pentapus setosus* Cuvier & Valenciennes. *Bakutut*.

Two specimens from Bulan (no. 3844 and 3846: length 5 and 5.1 in.) and 1 from Jolo (no. 3204; length 7.95 in.). Dorsal x, 9; anal iii, 7; scales 45; depth 3.1; head 3.1. Small specimens show a dark spot at base of caudal.

Pentapus setosus Cuvier & Valenciennes, Hist. Nat. Poiss., vi, 200 (270), Batavia; Günther, Cat., i, 382; Bleeker, Atlas, viii, 101, pl. cccxxiv, fig. 1.

155. *Plectorhynchus pictus* (Thunberg).

One specimen from Bulan (no. 4142; length 7 in.), and one from Jolo (no. 4068; length 9 in.).

Perca picta Thunberg, K. Vetensk. Acad. n. Handl., xiii, 143, pl. 5, 1792, no locality.

Diagramma pictum, Günther, Cat., i, 327.

Plectorhynchus pictus, Bleeker, Atlas, viii, 24, pl. cccxxix, fig. 4.

156. *Plectorhynchus chrysotænia* (Bleeker).

Two small specimens from Bulan (no. 4201; length 2 and 3.2 in.).

Diagramma chrysotænia Bleeker, Nat. Tijds. Ned. Ind., ix, 1855, 303, Celebes.

Plectorhynchus chrysotænia, Bleeker, Atlas, viii, 16, pl. cccxxix, fig. 1; Günther, Cat., i, 333.

157. *Plectorhynchus goldmanni* (Bleeker). *Manila*.

One specimen from Jolo (no. 3219; length 8 in.), and one from San Fabian (no. 4150; length 7 in.).

Diagramma goldmanni Bleeker, Nat. Tijds. Ned. Ind., iv, 602, 1853, Ternate; Günther, Cat., i, 331.

Plectorhynchus goldmanni Bleeker, Atlas, viii, 21, and Atlas, vii, pl. ccxcv, fig. 2.

158. *Plectorhynchus celebicus* Bleeker. *Kiting*.

Two specimens from Jolo (no. 4064; length 2.5 and 10.5 in.). This species is easily distinguished from *P. chrysotænia*, in which the caudal is not notched.

Plectorhynchus celebicus Bleeker, Ned. Tijds. Dierk., iv, 1873, 285, Celebes; Atlas, viii, 18, pl. cccxxix, fig. 3.

159. *Scolopsis cancellatum* (Cuvier & Valenciennes).

Two specimens from Bacon (no. 3420 and 3887, length 4.2 and 6.75 in.), and 2 from Bulan (no. 3209 and 4071; length 6.1 and 6.2 in.).

Scolopsides cancellatus Cuvier & Valenciennes, Hist. Nat. Poiss., v, 264 (351), 1830, Sandwich Islands, Waigiou and Rauwac.

Scolopsis cancellatus, Günther, Cat., i, 361 (Sumatra); Day, Fishes India, 86, pl. xxii, fig. 6.

160. *Scolopsis bilineatum* (Bloch).

One specimen from Bulan (no. 3875; length 5.75 in.).

Anthias bilineatus Bloch, Ichth., x, 1, pl. cccxxv, fig. 1, 1797, Japan.

Scolopsis bilineatus, Günther, Cat., i, 357 (Amboyna; Celebes); Day, Fishes India, 85, pl. xxii, fig. 3 (Andamans).

161. *Scolopsis margaritifera* (Cuvier & Valenciennes).

Four specimens from Bacon (no. 3736, 3360, 3537, and 3499; length 7.5 to 8 in.), and 2 from Bulan (no. 4134 and 3796; length 7.5 and 8.2 in.). Depth 2.5; head 3.2; dorsal x, 9; anal iii, 7; scales 37.

Scolopsides margaritifera Cuvier & Valenciennes, Hist. Nat. Poiss., v, 254 (337), Waigiou.

Scolopsis margaritifera, Günther, Cat., i, 355; Bleeker, Atlas, vii, pl. cccxvii, fig. 2, and Atlas, viii, 3.

162. *Scolopsis luzonia* Jordan & Seale.

Thirteen specimens from Bacon (no. 3730 to 3733, 3403 to 3406, 3829 to 3831, 4001 and 4017; length 4 to 6 in.), and one from San Fabian (no. 3332). A prominent serrated ridge on maxillary.

Scolopsis luzonia Jordan & Seale, Bull. Bu. Fisheries, XXVI, 1906, Cavite, Luzon. (Collected by Dr. Lung; type, no. 9243, Stanford Univ.).

163. *Scolopsis monogrammus* (Kuhl & Van Hasselt).

One specimen from Bulan (no. 3277; length 5.85 in.).

Head 3 in length; depth 2.8; eye 3.5 in head; snout 3; interorbital equals eye; scales 5-48-11, 6 rows on cheek.

Color in spirits, yellowish; an indistinct dusky band almost width of eye from head to caudal.

This species is close to *S. personatus*, from which it differs in the greater depth, narrower interorbital, smaller scales, and in having 6 rows of scales (instead of 5) on the cheek.

Scolopsides monogramma Kuhl & Van Hasselt in Cuvier & Valenciennes, Hist. Nat. Poiss., v. 254 (338) Java; Günther, Cat., 1, 358.

Scolopsis monogramma, Bleeker, Atlas, VIII, 11, pl. CCCXXXV, fig. 3.

164. *Scolopsis bulanensis* Evermann & Seale, new species.

Head 3.25 in length; depth 3.3; eye 2.75 in head; interorbital 3.5; snout 3.55; dorsal x, 9; anal III, 7; scales 4-43-10.

Body oblong, moderately compressed; depth of caudal peduncle 3 in head; anterior profile of head slightly convex above eyes; mouth rather small, jaws equal; maxillary 3.75 in head, its distal end not reaching to

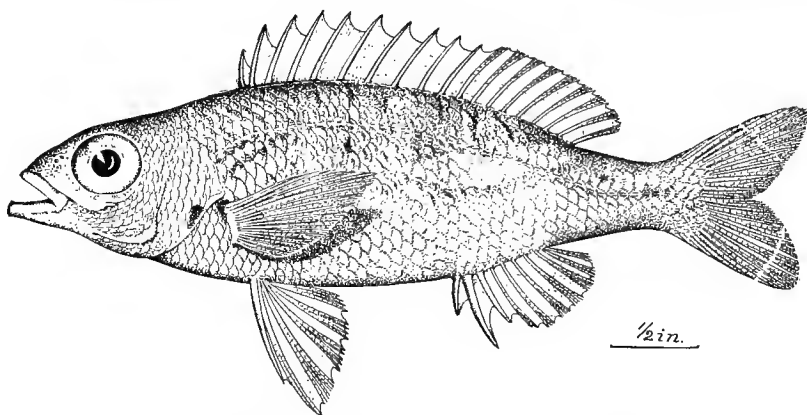

FIG. '5.—*Scolopsis bulanensis* Evermann & Seale, new species. Type.

anterior margin of orbit; mandible 2.95 in head; teeth villiform in jaws and on vomer; preorbital width 3 in eye, with one strong spine above and 2 smaller ones below, the large one reaching slightly past middle of eye; gillrakers consisting of blunt knobs, about 7 on lower arch; posterior margin of preopercle denticulate; opercle with a single spine at its posterior margin; body fully scaled, 5 series on cheek; scales on top of head minute, those on belly larger; vertical fins unscaled, but fitting into scaly sheath; origin of dorsal slightly posterior to origin of pectoral, longest spine 2.75 in head, longest ray 2.75; origin of anal nearer origin of ventrals than to base of caudal, its longest ray 2.7 in head, the second anal spine longest and strongest, 2.5 in head, base of anal 3.6 in base of dorsal; ventrals 1.3 in head, their tip falling far short of anal; pectoral 1.35 in head, scarcely reaching tip of ventrals; caudal forked.

Color in spirits, dull yellowish brown; an indistinct dusky longitudinal line on side; short oblique black lines between pectoral fin and lateral line; an oblong white blotch extending forward and downward from posterior axil of dorsal to near middle of body; a black spot at axil of pectoral, another on posterior portion of opercle just in front of pectoral; fins unmarked.

This species is related to *S. personatus*, from which it differs in the larger eye, more slender body, and the color.

One specimen, the type, no. 55909, U. S. National Museum (original no. 3845), 4.25 inches long, from Bulan Sorsogon, P. I.; collector Charles J. Pierson.

Family SPARIDÆ.

165. *Sparus calamara* Russell.

One specimen from Bulan (no. 3258; length 6.5 in.). Pectoral longer than head; ventrals reaching past vent.

Sparus calamara Russell, Fishes Coromandel, I, pl. 92, 1803, Coromandel.

Chrysophrys calamara, Cuvier & Valenciennes, Hist. Nat. Poiss., VI, 85 (117); Günther, Cat., I, 493.

Chrysophrys berda var. *calamara*, Day, Fishes India, 140, pl. XXXV, fig. 2 (Sind and Malabar).

166. *Lethrinus nematacanthus* Bleeker.

Three specimens from Bulan (no. 3457, 3458, and 3946; length 4.75 to 6 in.). This species is easily distinguished by the elongate second dorsal spine which is contained 1.5 in head. A black spot between pectoral and lateral line.

Lethrinus nematacanthus Bleeker, Ichth. Japon., 90, Verh. Bat. Gen., XXVI, 1854, Japan; Bleeker, Atlas, VIII, 114, pl. CCCXXXVII, fig. 3; Günther, Cat., I, 456 (Louisiade Archipelago).

167. *Lethrinus richardsoni* Günther.

Twenty-five specimens from Bacon (no. 3205 to 3208, 3236, 3237, 3238, 3313, 3317 to 3323, 3329 to 3341, 3527 to 3530, 3820, 3821, and 3967; length 3.75 to 6.5 in.).

Lethrinus hamatopterus, Richardson, Voy. Sulphur, 144, pl. 64, fig. 1; not of Temminck & Schlegel.

Lethrinus richardsoni Günther, Cat., I, 456, 1859, China; Hongkong; Jordan & Evermann, Proc. U. S. Nat. Mus., XXV, 1903, 350 (Formosa).

168. *Lethrinus mcensii* Bleeker.

Four specimens from Bacon (no. 3526, 3452, 3934, and 3969; length 4.5 to 6.5 in.).

Lethrinus mcensii Bleeker, Nat. Tijds. Ned. Ind., IX, 1855, 435, Batjan; Bleeker, Atlas, VII, pl. CCXCVII, fig. 3, and Atlas, VIII, 115; Günther, Cat., I, 465 (Copang; Timor; Louisiade Archipelago); Fische der Südsee, 64, pl. 46, fig. A (Paumotu; Harvey; Pelew; Kingsmill; Society Islands).

169. *Lethrinus variegatus* Ehrenberg.

One specimen from San Fabian (no. 3326; length 6.5 in.). Known by its slender body, long snout, and peculiar conical lateral teeth.

Lethrinus variegatus Ehrenberg in Cuvier & Valenciennes, Hist. Nat. Poiss., VI, 213 (287), Massauah, Suez; Bleeker, Atlas, VII, pl. CCXCVII, fig. 1, and Atlas, VIII, 117, pl. CCCXXVIII, fig. 3, and pl. CCCXXX, fig. 2.

170. *Lethrinus hypselopterus* Bleeker.

One specimen from "Philippine Islands" (no local label, no. 4169; length 10.2 in.).

Head 3 in length; depth 2.6; eye 4 in head; snout 2; preorbital 2.4; scales 6-46-14; dorsal x, 9; anal III, 7; pectoral nearly as long as head.

Lethrinus hypselopterus Bleeker, Nat. Tijds. Dierk., IV, 326, Sumatra; Atlas, VIII, 114, pl. CCCXXX, fig. 3.

171. *Lethrinus harak* (Forskål). *Bakutut*.

One specimen from Jolo (no. 4109; length 9 in.), 9 from Bacon (no. 3316, 3453 to 3456, 3970, 3968 and 3525; length 2.25 to 6.75 in.), and 2 from San Fabian (no. 3338; length 2.5 and 2.75 in.).

Sciæna harak Forskål, Descr. Anim., 52, 1775, Red Sea.

Lethrinus harak, Günther, Cat., I, 458 (Red Sea); Bleeker, Atlas, VIII, 119, pl. CCXCVII, fig. 3; Day, Fishes of India, 137, pl. XXX, fig. 3.

172. *Lethrinus ornatus* Cuvier & Valenciennes.

One specimen from Bulan (no. 3862; length 1.95 in.).

Lethrinus ornatus Cuvier & Valenciennes, Hist. Nat. Poiss., vi, 231 (310), **Java**; Bleeker, Atlas, viii, 118, pl. cccL, fig. 4.
Lethrinus xanthotænia Bleeker, Nat. Tijds. Ned. Ind., ii, 1851, 176, **Sumatra**; Günther, Cat., i, 461.

173. *Lethrinus mahsenoides* Ehrenberg.

One specimen from Philippines (no local label, no. 4167; length 10.2 in.).

Lethrinus mahsenoides Ehrenberg in Cuvier & Valenciennes, Hist. Nat. Poiss., vi, 212 (286), **no locality given**; Günther, Cat., i, 464 (Philippines; Amboyna); Bleeker, Sparoiden., 15, Ver. Bat. Gen., xxiii, 1850.

Family SCLERIDÆ.

174. *Umbrina dussumieri* Cuvier & Valenciennes. *Ibot.*

Five specimens from San Fabian (no. 4097 to 4101; length 4 to 5.25 in.).

Umbrina dussumieri Cuvier & Valenciennes, Hist. Nat. Poiss., ix, 355 (481), **Coromandel**; Günther, Cat., ii, 278; Bleeker, Atlas, ix, pl. cccLXXXvii, fig. 4; Day, Fishes of India, 183, pl. XLIII, figs. 2 and 3.

175. *Umbrina russelli* Cuvier & Valenciennes. *Belaque.*

Three specimens from San Fabian (no. 3268 to 3270; length 4.75 and 6.1 in.).

Umbrina russelli Cuvier & Valenciennes, Hist. Nat. Poiss., v, 132 (178), **Coromandel**; Günther, Cat., i, 278; Day, Fishes of India, 183, pl. XLIII, fig. 4.
Sciæna russelli Bleeker, Atlas, ix, pl. cccLXXXvi, fig. 2.

176. *Otolithus argenteus* Kuhl & Van Hasselt.

One specimen from Bacon (no. 3441; length 9 in.).

Otolithus argenteus Kuhl & Van Hasselt in Cuvier & Valenciennes, Hist. Nat. Poiss., v, 47 (62), **Batavia**; Günther, Cat., ii, 310; Bleeker, Atlas, ix, pl. cccLXXXv, fig. 5.

177. *Johnius belengeri* (Cuvier & Valenciennes). *Ibot.*

One specimen from San Fabian (no. 3709; length 7.75 in.).

Corvina belengeri Cuvier & Valenciennes, Hist. Nat. Poiss., v, 89 (120); Günther, Cat., ii, 303 (Malabar).
Johnius belengeri, Bleeker, Atlas, ix, pl. cccLXXXvii, fig. 1.

Family SILLAGINIDÆ.

178. *Sillago macrolepis* Bleeker.

Two specimens from Bulan (no. 4094 and 4095; length 7.25 and 8 in.). Eye 4 in head, 1.75 in snout; snout 2.35 in head; scales about 60.

Sillago macrolepis Bleeker, Nat. Tijds. Ned. Ind., xvii, 1858, 186, **Bali**, and Atlas, ix, pl. cccLXXXix, fig. 1; Günther, Cat., ii, 246.

Family MULLIDÆ.

179. *Mulloides vanicolensis* (Cuvier & Valenciennes).

Two specimens from Zamboanga (no. 4090 and 4091; length 9 and 10 in.).

Upeneus vanicolensis Cuvier & Valenciennes, Hist. Nat. Poiss., vii, 391 (521), **Vanicolo**.
Mulloides vanicolensis, Jordan & Evermann, Bull. U. S. Fish Comm., xxiii, pt. 1, 1903 (July 29, 1905), 254.

180. *Mulloides samoensis* Günther. *Tubac.*

One specimen from San Fabian (no. 4130; length 5.55 in.) and one from Bacon (no. 4131; length 6.25 in.). This species is easily distinguished by the black spot on side under posterior end of pectoral.

Mulloides samoensis Günther, Fische der Südsee, 57, pl. 43, fig. B, **Apia, Samoa**; Jordan & Evermann, Bull. U. S. Fish Comm., xxiii, 1903, 253, fig. 105 (Oahu Island; Hilo).

181. *Mulloides japonicus* (Houttuyn).

Four specimens from Bulan (no. 3901 to 3904; length 4.75 in.). Head 3.5 in length; depth 3.85; scales 30; 3 or 4 dusky oblique bands on caudal, almost obliterated on lower lobe, an indistinct dusky line on side from head to caudal.

No difference can be detected in these specimens when compared with specimens from Japan.

Mullus japonicus Houttuyn, Verh. Holl. Maat. Weet. Haarlem, xx., deels, 2 stuk, 1782, p. 311-346, Nagasaki.

Mulloides japonicus, Günther, Cat., i, 404; Snyder, Proc. U. S. Nat. Mus., xxxi, 1906, 552 (Misaki).

Upeneus japonicus, Cuvier & Valenciennes, Hist. Nat. Poiss., iii, 339 (460), 1829 (Japan).

182. *Upeneus tragula* Richardson.

Three specimens from Bacon (no. 3634 to 3636; length 5.25 to 6.5 in.).

Upeneus tragula Richardson, Ichth. China, in Rept. Brit. Assoc., xv, 1845, 220, Canton; Günther, Cat., i, 398.

183. *Upeneus sulphurus* Cuvier & Valenciennes. *Belague*.

Six specimens from San Fabian (no. 3921; length 3.5 in.).

Upeneus sulphurus Cuvier & Valenciennes, Hist. Nat. Poiss., iii, 331 (450), Antje.

Upeneoides sulphureus, Günther, Cat., i, 398.

184. *Upeneus sundaicus* (Bleeker).

One specimen from Bacon (no. 3201; length 5.1 in.). Head 3.5 in length; depth 3.75; eye 4 in head; interorbital 4; scales 2-32-5; dorsal VIII, 9; anal II, 6; teeth in villiform bands on jaws, palatines, and vomer, those on vomer very minute, easily overlooked, possibly sometimes absent. Color in spirits yellowish, an indistinct dark longitudinal line from eye to caudal; fins unmarked.

Upeneoides sundaicus Bleeker, Nat. Tijds. Ned. Ind., VIII, 1855, 411, East Indies, and Atlas, IX, pl. cccxciv, fig. 2; Günther, Cat., i, 399.

185. *Pseudupeneus moana* Jordan & Seale.

One specimen from Bacon (no. 3249; length 9 in.).

Upeneus trifasciatus Günther, Fische der Südsee, 59, pl. 44, fig. B (Vavau; Samoa; Amboyna); not of Lacépède

Pseudupeneus moana Jordan & Seale, Fishes of Samoa, Bull. Bu. Fisheries, xxv, 1905 (1906), 274, Samoa.

186. *Pseudupeneus bifasciatus* (Lacépède). *Pinovugnan*.

One specimen from Bacon (no. 3275; length 8.75 in.).

Mullus bifasciatus Lacépède, Hist. Nat. Poiss., III, 404, pl. 14, fig. 2, 1801, no locality.

Pseudupeneus bifasciatus, Jordan & Evermann, Bull. U. S. Fish. Comm., xxiii, 1903, 258, fig. 107 (Hawaiian Islands)

187. *Pseudupeneus barberinus* (Lacépède).

One specimen from San Fabian (no. 3972; length 5.2 in.) and one from Bacon (no. 3886; length 4.75 in.).

Mullus barberinus Lacépède, Hist. Nat. Poiss., III, 406, pl. 13, fig. 3, 1801.

Upeneus barberinus, Günther, Cat., i, 405 (Amboyna; Moluccas; India).

188. *Pseudupeneus indicus* (Shaw). *Tiao*.

Three specimens from Bacon (no. 3615, 3616, and 4108; length 5.5 to 6.5 in.) and one from Bulan (no. 3672; length 7.75 in.).

Mullus indicus Shaw, Zool., IV, pt. 2, 614, 1803, Indian Seas.

Upeneus indicus, Günther, Cat., i, 406 (China).

189. *Pseudupeneus spilurus* (Bleeker).

One specimen from Bulan (no. 3861; length 4 in.). This species has a distinct black spot on caudal peduncle above the lateral line and a dusky blotch at the anterior origin of lateral line.

Upeneus spilurus Bleeker, Nat. Tijds. Ned. Ind., VI, 395, 1854, Nagasaki; Günther, Cat., i, 406.

190. *Pseudupeneus luteus* (Cuvier & Valenciennes).

One specimen from Jolo (no. 4141; length 7.5 in.). Head 3.1 in length; depth 3.51; eye 5 in head; snout 2; scales 30; barbels short, not reaching base of ventral. Color in spirits, uniform yellow, no saddle over caudal peduncle.

Upeneus luteus Cuvier & Valenciennes, Hist. Nat. Poiss., VII, 392 (521), Ile de France; Day, Fishes of India, 125, pl. XXXI, fig. 2.

Parupeneus luteus, Bleeker, Atlas, IX, pl. cccxciv, fig. 1.

Family POMACENTRIDÆ.

191. *Pomacentrus trimaculatus* Cuvier & Valenciennes. *Bitilla*.

Two specimens from Bacon (no. 3798 and 3790; length 5.25 in.) and one from San Fabian (no. 3972).

Pomacentrus trimaculatus Cuvier & Valenciennes, Hist. Nat. Poiss., V, 320 (427), no locality; Günther, Cat., IV, 19; Day, Fishes of India, 382, pl. LXXX, fig. 10.

Dischistodus trimaculatus, Bleeker, Atlas, IX, pl. cccciv, fig. 5.

192. *Pomacentrus jerdoni* Day.

Thirteen specimens from Bulan (no. 3391 to 3399 and 3786 to 3789; length 3.75 to 6 in.).

These agree with Day's description in every respect. They have 13 dorsal spines, a black spot on upper axil of pectoral, the lateral line discontinued under posterior end of soft dorsal, and not continued on caudal peduncle, as in *P. tapinosoma*, which has only 12 dorsal spines.

Pomacentrus jerdoni Day, Fishes of India, 383, pl. LXXX, fig. 7, Madras.

193. *Pomacentrus moluccensis* Bleeker.

One specimen from Bacon (no. 3895; length 2.75 in.). Color yellowish brown; a small black spot at origin of lateral line, another in upper axil of pectoral.

Pomacentrus moluccensis Bleeker, Nat. Tijds. Ned. Ind., IV, 1853, 118, Amboyna, and Atlas, IX, pl. ccccn, fig. 3 (Molucca) Günther, Cat., IV, 30.

194. *Pomacentrus littoralis* Kuhl & Van Hasselt. *Kiting*.

Two specimens from Bacon (no. 3896 and 3852; length 4 in.). Preopercle and preorbital strongly serrated. Color in spirits, brownish, including all the fins; a small dusky spot at origin of lateral lines; some bluish markings on head.

This species is similar to *P. moluccensis* in some respects, but the latter is a deeper fish, considerably lighter in color, with a black spot in axil of pectoral.

Pomacentrus littoralis Kuhl & Van Hasselt in Cuvier & Valenciennes, Hist. Nat. Poiss., V, 318 (425), Java; Bleeker, Atlas IX, pl. cccciv, fig. 8; Günther, Cat., IV, 32 (Amboyna; Dove Island; Port Essington).

195. *Pomacentrus tripunctatus* Cuvier & Valenciennes.

Eleven specimens from Bacon (no. 3679 and 3681 to 3690; length 2.5 to 3.5 in.).

These specimens are all uniform brownish in color, the caudal scarcely lighter; a distinct round black spot on top of caudal peduncle posterior to axil of soft dorsal fin; preopercle and preorbital denticulate. Our specimens agree with Bleeker's figure, except that they are not quite so deep, the depth being 2.2 in length without caudal; preorbital distinctly serrate.

Pomacentrus tripunctatus Cuvier & Valenciennes, Hist. Nat. Poiss., V, 315 (421), Vanicolo; Günther, Cat., IV, 33.

Pomacentrus trilineatus, Günther, Cat., IV, 25; Bleeker, Atlas, IX, pl. ccccv, figs. 1-6.

196. *Pomacentrus tæniurus* Bleeker.

One specimen from Philippine Islands (no local label; no. 3998; length 2.75 in.).

Preopercle but slightly denticulate. A black spot at beginning of lateral line; posterior part of soft dorsal whitish—probably yellow in life.

Pomacentrus tæniurus Bleeker, Act. Soc. Sc. Ind. Ned., I, Amboina, 51, 1856, Amboyna; Atlas, IX, pl. ccccviii, fig. 2; Günther, Cat., IV, 22.

197. *Pomacentrus popei* Evermann & Seale, new species.

Head 3 in length; depth 1.9; eye 2.8 in head; snout 3.5; interorbital 2.75; dorsal XIII, 12; anal II, 13; scales 3-24-9.

Body elevated, compressed; depth of caudal peduncle 2 in head; anterior profile evenly rounded; jaws equal; a single series of blunt, rather strong teeth in each jaw, none on vomer or palatines; gillrakers sharp, 13 on lower limb, the longest equal to one-half eye; maxillary not reaching anterior margin of eye, its length equal to eye; mandible 2.75 in head; greatest preorbital width 2 in eye, its margin denticulate with a rather strong spine below anterior third of eye; preopercle strongly denticulate; opercle with a single spine on its posterior margin; body and head fully covered with firm pectinate scales; no scales on preorbital, about 3 rows of scales on cheek; scales on top of head small, about 20 series in front of dorsal; origin of dorsal on line with axil of pectoral, the distance between tip of snout and origin of dorsal 2.2 in length; longest spine 2.25 in head; middle ray of soft dorsal longest, 1.35 in head; origin of anal fin midway between base of caudal and origin of ventral, the middle rays of fin longest, 1.35 in head; second anal spine longest, 1.75 in head; origin of ventral below axil of pectoral, its tip reaching vent; pectoral equal to head; caudal emarginate, 1.1 in head.

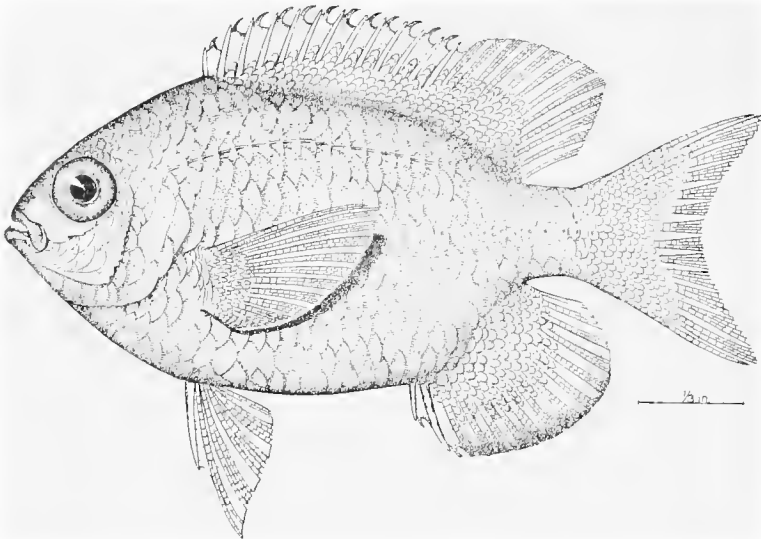

FIG. 16.—*Pomacentrus popei* Evermann & Seale, new species. Type.

Color in spirits, straw-yellow, no spots or dots on body or in axil of any fin; anal fin rather broadly margined with black; a narrow brownish margin to dorsal, indistinct on soft dorsal; otherwise fins all yellow, unmarked.

One fine specimen (no. 3470; length 2.45 in.). Type, no. 55903, U. S. National Museum, collected by Charles J. Pierson at Bacon, Sorsogon, P. I.

Named for our friend and associate, Mr. Thomas Edmund Burt Pope, scientific assistant, U. S. Bureau of Fisheries.

198. *Pomacentrus alexanderæ* Evermann & Seale, new species.

Head 3.45 in length; depth 2; eye 3 in head; interorbital 3.2; snout 4.5; dorsal XIII, 14; anal II, 14; scales 4-27-9.

Body compressed, elevated; depth of caudal peduncle 2 in head; anterior profile evenly rounded; mouth small; teeth in a single row in each jaw; maxillary ending on a line with anterior margin of orbit, its length slightly less than eye; mandible 3.1 in head; preorbital with some minute denticulations and one rather strong spine below anterior margin of pupil; greatest width of preorbital 2.5 in eye; preopercle distinctly denticulate; opercle with spine on posterior margin; gillrakers small, sharp-pointed, 13 on lower limb, the

longest 2.5 in eye; 2 or 3 rows of scales on cheek; body and head fully scaled; lateral line with but 16 distinct tubules; about 20 series of scales in front of dorsal; origin of dorsal on a line with axil of pectoral, the spines gradually increasing in length, the last being longest, 1.5 in head, the anterior spine scarcely equal to eye; webs of spinous dorsal deeply incised; middle soft dorsal ray the longest, 1.25 in head; origin of anal below base of eleventh dorsal spine, its base 1.1 in head, its longest ray 1.3, the second spine 1.55; vertical fins with deep scaly sheath; ventral slightly nearer origin of anal fin than to tip of snout, its tip reaching vent; pectoral equal to length of head; caudal emarginate, the lobes pointed, length greater than head.

Color in spirits, dull yellowish, shading gradually into a soft brown on upper anterior portion of body and head; a large, deep, black spot covering entire base and axil of pectoral fin; some slight indications of very indistinct yellow longitudinal lines on side; spinous dorsal brownish, with dusky margin extending along upper edge of soft dorsal; soft dorsal becoming yellow on posterior half; anal yellow, the marginal third dusky; caudal yellow; ventrals with slight tint of dusky; pectoral yellow.

Seven specimens from Bacon (no. 3996 and 3905; length 3.25 to 3.5 in.). Type, no. 55919, U. S. National Museum, from Bacon, Sorsogon, P. I., length 3.5 in., collected by Mr. Charles J. Pierson. Of the cotypes one

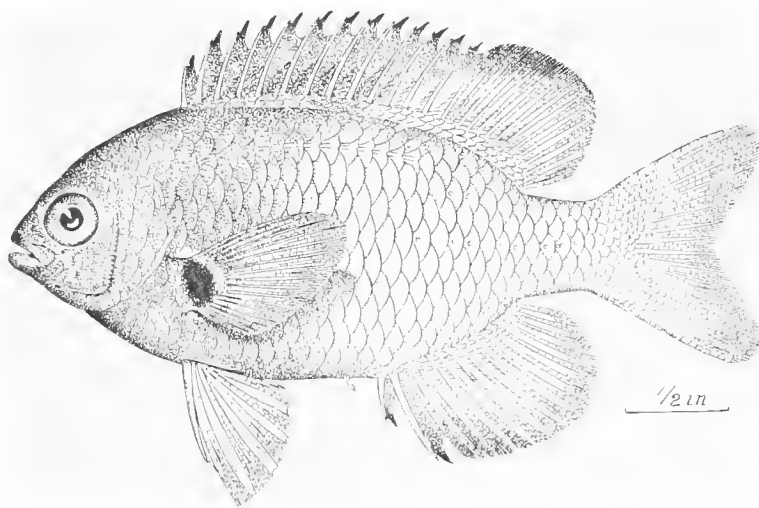

FIG. 17.—*Pomacentrus alexandra* Evermann & Seale, new species. Type.

(Bureau of Fisheries, no. 3996) is no. 20005, Stanford University Museum; another is no. 4540, U. S. Bureau of Fisheries, and there is one each in the museum at Manila, Philadelphia Academy of Natural Sciences, U. S. National Museum, and Indiana University Museum.

Named for Miss Annie M. Alexander, of Oakland, California, in recognition of her interest and work in zoology.

199. *Pomacentrus philippinus* Evermann & Seale, new species.

Head 3.35 in length; depth 2; eye 3 in head; snout 4.1; interorbital 2.75; dorsal XIII, 14; anal II, 14; scales 4-26-9, -18 tubes.

Body oblong, compressed; depth of caudal peduncle 1.75 in head; anterior profile evenly rounded; jaws equal; maxillary scarcely equal to diameter of eye, its distal end under anterior margin of eye; mandible 3 in head; small teeth in jaws in single series, none on vomer or palatines; gillrakers slim, sharp-pointed, 12 on lower limb, the longest about equal to pupil; preorbital with 2 or 3 small denticulations, greatest width of preorbital 3 in eye; preopercle distinctly denticulate; opercle with a single spine on posterior border; body and head fully scaled, a single row on preorbital, 2 rows on cheek, a single row on lower limb of preopercle; very fine scales on top of head, about 23 series in front of dorsal; origin of dorsal above axil of pectoral; distance between origin of dorsal and tip of snout 1.25 in depth of fish; longest dorsal spine 1.75 in head, length of anterior spines 4.75; middle ray of dorsal longest, equal to head, its tip slightly produced; webs of spinous dorsal incised; origin of anal nearer base of ventral than base of caudal, the second spine the longest, 2.45 in head; middle ray of anal longest, about

equal to head, the tip slightly produced; ventral below axil of pectoral, the first ray produced into a filament reaching posterior to vent; pectoral slightly greater than head, its tip on a line with vent; caudal greater than head, the lobes produced.

Color in spirits, purplish, slightly lighter on thorax; caudal yellow, fading into purplish on caudal peduncle; lower half of soft dorsal and upper half of anal yellow, the other portion of these fins dusky, the line of demarcation between the 2 colors abrupt; ventrals black; pectoral dusky, a black spot on upper two-thirds of pectoral base and on axil of fin.

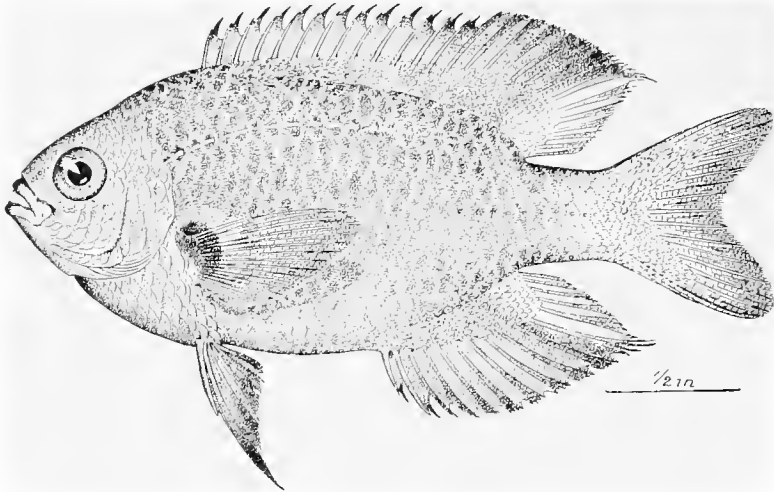

FIG. 18.—*Pomacentrus philippinus* Evermann & Seale, new species. Type.

Two specimens from Bacon (no. 4207 and 4028; length 2.5 and 2.75 in.). Type, no. 55901, U. S. National Museum, from Bacon, Sorsogon, P. I., collected by Charles J. Pierson, and cotype, no. 20009, Stanford University Museum.

200. *Abudefduf xanthurus* (Bleeker).

Eleven specimens from Bacon (no. 3461 to 3469, 3906, and 3854; length 3.5 to 4.5 in.).

Glyphisodon xanthurus: Bleeker, Nat. Tijds. Ned. Ind., v, 1853, 345, Amboyna; Günther, Cat., iv, 47 (Ceram; Amboyna).
Paraglyphisodon xanthurus Bleeker, Atlas, ix, pl. ccccv, fig. 3.

201. *Abudefduf bankieri* (Richardson).

Five specimens from Bacon (no. 3891, 4205, and 4206; length 1.75 to 2.5 in.).

Glyphisodon bankieri Richardson, Ichth. China, 253, 1846, Hongkong; Günther, Cat., iv, 54 (China).
Parapomacentrus bankieri Bleeker, Atlas, ix, pl. ccccviii, fig. 8.

202. *Abudefduf zonatus* (Cuvier & Valenciennes).

Two specimens from Bacon (no. 4208 and 3680; length 2 and 2.5 in.).

Glyphisodon zonatus Cuvier & Valenciennes, Hist. Nat. Poiss., v, 361 (483), 1830, New Guinea.
Glyphisodontops zonatus, Bleeker, Atlas, ix, pl. ccccvii, fig. 3.
Glyphisodon brownriggii Günther, Fische der Südsee, 232, pl. 127, fig. A and C; in part.

203. *Abudefduf cyaneus* (Quoy & Gaimard).

Four specimens from Bacon (no. 3863 and 4212; length 1.2 to 2.25 in.). Dorsal XIII, 12; preorbital and preopercle entire; depth 2.2 without caudal; head 3.35. Color in spirits deep blue; pectoral, soft dorsal, caudal, ventral, and anal yellowish; a small indistinct deeper blue spot at origin of lateral line; no spot in axil of pectoral or on soft dorsal; no stripes on head.

One specimen (no. 4212) is uniform blue without yellowish on fins. This specimen is slightly less in depth than the others, the ventral fins being also a little darker in color.

Glyphisodon cyaneus Quoy & Gaimard, Voy. Uranie, Zool., 392, pl. 64, fig. 3, 1824; no locality.

204. *Abudefduf antjerius* (Kuhl & Van Hasselt).

Three specimens from Bacon (no. 3470, 3471, and 4210; length 1.4 to 2.1 in.).

Glyphisodon antjerius Kuhl & Van Hasselt in Cuvier & Valenciennes, Hist. Nat. Poiss., v, 360 (481), **Antjer**; Günther, Cat., IV, 50 (Amboyna; Borneo).

205. *Abudefduf glaucus* (Cuvier & Valenciennes).

Three specimens from Bacon (no. 4202 to 4204; length 2 to 2.5 in.).

Glyphisodon glaucus Cuvier & Valenciennes, Hist. Nat. Poiss., v, 355 (475), 1830, **Guam**.

206. *Abudefduf curacao* (Bloch).

Seven specimens from Bacon (no. 4020, 4021, 3925, 3926, 3779, 3877, and 3879; length 2.75 to 4 in.). These specimens differ from the descriptions and figure in having the lower posterior part of anal dusky and a dusky wash on upper and lower margin of caudal, but not as in *A. caelestinus*, with which we have compared it.

Chaetodon curacao Bloch, Ichth., VI, 79, pl. CCXII, fig. 1, 1797, **Curacao**.

Glyphisodon trifasciatus; Günther, Cat., IV, 42 (Amboyna; Ceram).

207. *Abudefduf septemfasciatus* (Cuvier & Valenciennes).

One specimen from Bulan (no. 3879; length 4.95 in.).

Glyphisodon septemfasciatus Cuvier & Valenciennes, Hist. Nat. Poiss., v, 346 (463), 1830, **Ile de France**; Günther, Cat., IV, 40, 1862 (China; Philippine Islands; Ceylon).

208. *Abudefduf unimaculatus* (Cuvier & Valenciennes).

Two specimens from Bacon (no. 4209 and 4210; length 2 and 2.75 in.). Head 3.4 in total length; depth 2.1; dorsal XIII, 13; anal II, 12. Color in spirits purplish, a black spot in axil of soft dorsal.

Glyphisodon unimaculatus Cuvier & Valenciennes, Hist. Nat. Poiss., v, 358 (478), **Timor**.

Glyphidodon unimaculatus, Günther, Cat., IV, 51 (Borneo).

Glyphidodontops unimaculatus, Bleeker, Atlas, IX, pl. CCCCVII, fig. 5 (not 6, as labeled).

Family LABRIDÆ.

209. *Cheilinus fasciatus* (Bloch).

Three specimens from Bacon (no. 3971 to 3973; length 4.2 in.).

Sparus fasciatus Bloch, Ichth., VIII, 15, pl. CCLVII, 1797, **Japan**.

Cheilinus fasciatus, Günther, Cat., IV, 129 (Amboyna); Bleeker, Atlas, I, 67, pl. XXVI, fig. 2.

210. *Cheilinus chlorurus* (Bloch).

Five specimens from Bacon (no. 3503, 3504 and 3872 to 3874; length 4 to 7.75 in.).

Sporus chlorurus Bloch, Ichth., VIII, 21, pl. CCLX, 1797, "**Japan and St. Domingue**."

Cheilinus chlorurus, Günther, Cat., IV, 128 (Amboyna; Ceylon, Ceram; Aneityum); Bleeker, Atlas, I, 65, pl. XXVII, fig. 3.

211. *Stethojulis zatima* Jordan & Seale.

One specimen from Bacon (no. 4214; length 1.75 in.) and one without local label (no. 4191; length 1.5 in.).

Stethojulis zatima Jordan & Seale, Proc. U. S. Nat. Mus., XXVIII, 788, 1905, **Negros, Philippine Islands**.

212. *Stethojulis phekadopleura* (Bleeker).

One specimen from Bacon (no. 4215; length 2 in.).

Julis phekadopleura Bleeker, Ichth. fauna Bali, 8, Verh. Bat. Gen., XXII, 1849, **Bali**.

Stethojulis phekadopleura Bleeker, Atlas, I, 134, pl. XLIII, fig. 5; Günther, Cat., IV, 143.

213. *Cheilio inermis* (Forskål).

Fourteen specimens from Bacon (no. 3520, 3584 to 3586, 3413 to 3415, 3652, 3699, 3945, 3610, 3611, 3720 and 3836; length 3.2 to 13.5 in.).

Labrus inermis Forskål, Descr. Anim., 34, 1775, **Red Sea**.

Cheilio inermis, Jordan & Evermann, Bull. U. S. Fish Comm., XXIII, pt. 1, 1903 (1905), 314, pl. XXXIII (Honolulu; Hilo).

214. *Lepidaplois mesothorax* (Bloch & Schneider).

One specimen from Bacon (no. 3920; length 5.5 in.).

Labrus mesothorax Bloch & Schneider, Syst. Ichth., 254, 1801, India.

Cossyphus mesothorax, Günther, Cat., IV, 103 (Ceram; Amboyna); Bleeker, Atlas, I, 159, pl. xxxviii, fig. 4 (misprinted *meso-*
lyorax in text).

215. *Labroides paradiseus* Bleeker.

Two specimens from Bacon (no. 3843; length 2 and 2.75 in.).

Labroides paradisus Bleeker, Nat. Tijds. Ned. Ind., II, 249, Banda; Atlas, I, pl. XLIV, fig. 2.

216. *Thalassoma lunaris* (Linnæus).

One specimen from Bacon (no. 3995; length 4.75 in.). A small patch of scales on upper part of opercle; anal with 2 spines.

Labrus lunaris Linnæus, Syst. Nat., ed. x, 283, 1758, India.

Julis lunaris Bleeker, Atlas, I, 90, pl. xxxiii, fig. 5.

217. *Novaculichthys macrolepidotus* (Bloch).

One specimen from Bacon (no. 3918; length 4 in.). This specimen seems to have more dusky on the sides than any others so far examined, there being a wide, more or less interrupted, black band from head to caudal.

Labrus macrolepidotus Bloch, Ichth., VIII, 109, pl. cclxxxiv, 1797, East Indies.

Novaculichthys macrolepidotus, Bleeker, Atlas, I, 144, pl. xxxi, fig. 6.

Novacula macrolepidota, Günther, Cat., IV, 174 (Mozambique).

218. *Halichoeres scapularis* (Bennett).

Seven specimens from Bacon (no. 3840, 3963 to 3965, and 4147 to 4149; length 2 to 6.25 in.). These form a perfect series in size and intergradation of color from the figure and descriptions given by Bleeker and Day to the young as described by Jordan and Seale. There can be no doubt that *Guntheria caruleovittata*, *PlatyGLOSSUS scapularis*, and *H. cymatogrammus* are one and the same species, the difference in color markings being due to age.

Julis scapularis Bennett, Proc. Comm. Zool. Soc. Lond. 1831, 167, Mauritius.

Guntheria caruleovittata Bleeker, Atlas, I, pl. xxxii, fig. 2.

PlatyGLOSSUS scapularis, Day, Fishes India, 400, pl. LXXXV, fig. 4.

Halichoeres cymatogrammus Jordan & Seale, Proc. U. S. Nat. Mus., xxviii, 1905 (July 3), 786, fig. 8, Negros, Philippine Islands. (Young.)

219. *Halichoeres purpureus* (Bloch & Schneider).

One specimen from Bacon (no. 4014; length 5 in.).

Labrus purpureus Bloch & Schneider, Syst. Ichth., 262, 1801.

PlatyGLOSSUS purpurascens, Günther, Cat., IV, 158. Bleeker, Atlas, I, 108, pl. XLV, fig. 1.

220. *Halichoeres nigrescens* (Bloch & Schneider).

Two specimens from Bulan (no. 4075 and 4076; length 5.2 and 6.5 in.).

Labrus nigrescens Bloch & Schneider, Syst. Ichth., 263, 1801.

Halichoeres nigrescens Bleeker, Atlas, I, 118, pl. xxxvii, fig. 4.

221. *Halichoeres miniatus* (Kuhl & Van Hasselt).

Seven specimens from Bacon (no. 4003 and 4213; length 1 to 3 in.).

Julis miniatus Kuhl & Van Hasselt in Cuvier & Valenciennes, Hist. Nat. Poiss., xiii, 337 (400), Java; Günther, Cat., IV, 150.

Halichoeres miniatus, Bleeker, Atlas, I, 114, pl. xli, fig. 5.

222. *Halichoeres guttatus* (Bloch).

Five specimens from Bacon (no. 3753 and 4000; length 2.5 to 2.75 in.).

Labrus guttatus Bloch, Ichth., pl. cclxxxviii, fig. 2, 1797, New Holland.

Labrus argus Bloch & Schneider, Syst. Ichth., 263, 1801.

PlatyGLOSSUS guttatus, Günther, Cat., IV, 155 (Sumatra; Ceram; Chusan).

Halichoeres guttatus, Bleeker, Atlas, I, 124, pl. xxxv, fig. 1.

223. Halichæres leparensis (Bleeker). *Masanguî.*

Twelve specimens from Bacon (no. 3770 and 4001; length 1.25 to 2 in.) and one from San Fabian (no. 3835; length 1.25 in.).

Julis leparensis Bleeker, Nat. Tijds. Ned. Ind., III, 1852, 730, **Bangka**.

Halichæres leparensis Bleeker, Atlas, I, 119, pl. XLII, fig. 5.

PlatyGLOSSUS leparensis, Günther, Cat., IV, 156.

224. Halichæres pœcilus (Lay & Bennett).

Seven specimens from Bacon (no. 3980; length 1.5 to 3.5 in.).

Julis pœcila Lay & Bennett, Zool. Beech. Voy., Blossom, 66, pl. 19, fig. 1, **Looc-Choo Islands**.

Halichæres pœcila, Bleeker, Atlas, I, 115, pl. XXXIX, fig. 4.

PlatyGLOSSUS pœcilus, Günther, Cat., IV, 152.

Halichæres annulatus Fowler, Journ. Ac. Nat. Sci. Phila., 2d ser., XII, 535, pl. XX, upper fig., June 10, 1904, **Sumatra**.

Family PSEUDOCROMIDÆ.

225. Labracinus trispilos (Bleeker).

Two specimens from Bacon (no. 4216; length 1.2 and 1.25 in.).

Cichlops trispilos Bleeker, Nat. Tijds. Ned. Ind., IX, 1855, 110, **Halmaheira, Batjan**; Bleeker, Atlas, IX, pl. CCCXC, fig. 2.

226. Labracinus melanotænia (Bleeker).

One specimen from Bulan (no. 3933; length 5.5 in.).

Cichlops melanotænia Bleeker, Nat. Tijds. Ned. Ind., III, 1852, 765, **Macassar, Celebes**; Günther, Cat., II, 259.

Pseudochromis melanotænia, Bleeker Atlas, IX, pl. CCCXC, fig. 5.

Family SCARICHTHYIDÆ.

227. Choerops anchorago (Bloch). *Mulmul.*

Nine specimens from Bacon (no. 3552 to 3554, 3536, 3691, 3692, 4138, 4139, and 4066; length 5 to 8.5 in.), and one from Jolo (no. 3239; length 6 in.).

Sparus anchorago Bloch, Ichth., VIII, 85, pl. CCLXXVI, 1797.

Choerops anchorago, Günther, Cat., IV, 95 (Amboyna).

228. Choerops auritum (Kuhl & Van Hasselt). *Duldul.*

One specimen from Bacon (no. 3819; length 3 in.), and 2 (no. 4067 and 4070; length 9 in.), without definite locality.

The degree of development of the canine teeth varies greatly in this as in related species.

Scarus auritus Kuhl & Van Hasselt in Cuvier & Valenciennes, Hist. Nat. Poiss., XIV, 161 (218), 1839, **Java**.

Scarichthys auritus, Günther, Cat., IV, 213 (Amboyna; Hongkong; Aneityum); Bleeker, Atlas, I, 15, pl. I, fig. 3.

229. Scarichthys cœruleopunctatus (Rüppell). *Duldul.*

One specimen from Jolo (no. 4110), 2 from Bulan (no. 3241 and 3242; length 5.5 and 6.5 in.), and 3 from Bacon (no. 3737 and 3799; length 6 to 10.2 in.).

This species may be distinguished from *S. auritus* by the strong development of canine teeth.

Scarus (Calliodon) cœruleo-punctatus Rüppell, Neue Wirb., Fische, 24, pl. 7, fig. 3, **Djedda**; Günther, Cat., IV, 213; Bleeker, Atlas, I, 16, pl. I, fig. 2.

230. Calotomus genistriatus (Cuvier & Valenciennes). *Ogus; Palit.*

One specimen from Zamboanga (no. 3773; length 8.75 in.), and one from Jolo (no. 4055; length 9.75 in.).

Calliodon genistriatus Cuvier & Valenciennes, Hist. Nat. Poiss., XIV, 218 (293), 1839, **no locality given**; Günther, Cat., IV, 215; Bleeker, Atlas, I, 13, pl. I, fig. 1.

231. *Callyodon quoyi* (Cuvier & Valenciennes).

One specimen from Bacon (no. 3234; length 7.5 in.).

Scarus quoyi Cuvier & Valenciennes, Hist. Nat. Poiss., XIV, 203 (273), 1839, New Ireland (New Mecklenburg).
Pseudoscarus quoyi, Bleeker, Atlas, I, 29, pl. VI, fig. 3 (Ternate); Günther, Cat., IV, 239.

232. *Callyodon lacerta* (Cuvier & Valenciennes).

Three specimens from Bulan (no. 3938, 3939, and 3240; length 4.75 to 6.2 in.), and one from Bacon (no. 4126).

Scarus lacerta Cuvier & Valenciennes, Hist. Nat. Poiss., XIV, 161 (217), 1839, Pondicherry.
Pseudoscarus æruginosus Bleeker, Atlas, I, 40, pl. XVII, fig. 2, 1862; Günther, Cat., IV, 229.

233. *Callyodon oktodon* (Bleeker). *Mulmul*.

One specimen from Zamboanga (no. 3715; length 10.75 in.).

Pseudoscarus oktodon Bleeker, Versl. Kon. Akad. Wet., XII, 1861, 235, Buton; Bleeker, Atlas, I, 33, pl. XIII, fig. 2, 1862.
Pseudoscarus octodon, Günther, Cat., IV, 234.

234. *Callyodon balinensis* (Bleeker).

One specimen from Bacon (no. 3735; length 8.25 in.).

Scarus balinensis Bleeker, Ichth. Fauna Bali, 8, Verh. Bat. Gen., XXII, 1849, Bali.
Pseudoscarus balinensis Bleeker, Atlas, I, 39, pl. XVI, fig. 3, 1862; Günther, Cat., IV, 228.

Family CHÆTODONTIDÆ.

235. *Chætodon selene* Bleeker.

One specimen from Bulan (no. 4342; length 5.2 in.). This specimen shows a wide dusky longitudinal stripe along the median line of side from caudal, fading out near head.

Chætodon selene Bleeker, Nat. Tijds. Ned. Ind., V, 76, 1853, Solor; Günther, Cat., II, 30 (Amboyna).
Tetragonopterus (Chætodontops) selene Bleeker, Atlas, IX, pl. CCLXXVII, fig. 5.

236. *Chætodon auriga* Forskål.

One specimen from Bacon (no. 3694; length 4.75 in.).

Chætodon auriga Forskål, Descr. Anim., 60, 1775, Red Sea; Günther, Cat., II, 7 (Red Sea).
Tetragonopterus (Linophora) auriga, Bleeker, Atlas, IX, pl. CCLXXXIII, fig. 4.

237. *Chætodon vagabundus* Linnæus.

One specimen from Bacon (no. 3387; length 5.35 in.).

Chætodon vagabundus Linnæus, Syst. Nat., ed. X, 276, 1758, Indies; Günther, Cat., II, 25 (Mauritius; Amboyna); Fowler, Fishes of Sumatra, 544, 1904.
Tetragonopterus (Linophora) vagabundus, Bleeker, Atlas, IX, 48, pl. CCLXXVIII, fig. 1 (Sumatra, etc.).

238. *Chætodon falcula* Bloch.

Two specimens from Bacon (no. 3369 and 3370; length 5.1 and 5.25 in.).

Chætodon falcula Bloch, Ichth., XII, 100, pl. CCCXXVI, fig. 2, 1797, Coromandel; Günther, Cat., II, 17 (Batoe); Günther, Fische der Südsee, pl. 27, fig. c.
Tetragonopterus (Orychætodon) falcula, Bleeker, Atlas, IX, 52, pl. CCLXXIII, fig. 1.

239. *Chætodon octofasciatus* Bloch.

Two specimens from Bacon (no. 3894 and 3917; length 2.75 and 3.1 in.). These specimens show a dusky spot below the lateral line between the fourth and fifth black bands.

Chætodon octofasciatus Bloch, Ichth., VI, 85, pl. CCXV, fig. 1, 1797, East Indies; Günther, Cat., II, 17 (Singapore).
Tetragonopterus (Tetragonopterus) octofasciatus, Bleeker, Atlas, IX, 38, pl. CCLXXVI, fig. 3.

240. *Chætodon unimaculatus* Bloch.

One specimen from Bacon (no. 3342; length 4 in.). This specimen has a dusky wedge-shaped area extending down from the black spot.

Chætodon unimaculatus Bloch, Ichth., pl. cci, fig. 1, East Indies; Günther, Cat., II, 11.

Tetraodonoptrus (Lepidochætodon) unimaculatus, Bleeker, Atlas, IX, 45, pl. c.c.c.LXXV, fig. 5.

241. *Taurichthys varius* Cuvier & Valenciennes

One large specimen from Bacon (no. 3336; length 5.56 in.).

Taurichthys varius Cuvier & Valenciennes, Hist. Nat. Poiss., VII, 111 (148), pl. 181, 1831, no locality given.

Heniochus varius, Günther Cat., II, 41 (Molucca Sea; Amboyna).

242. *Heniochus acuminatus* (Linnæus). *Pampanon*.

One specimen from Bacon (no. 3437; length 4.25 in.), and 3 young from San Fabian (no. 3771; length 2 in.).

Chætodon acuminatus Linnæus, Syst. Nat., ed. x, 272, 1758, Indies.

Chætodon macrolepidotus Linnæus, Syst. Nat., ed. x, 274, 1758; after Artedi.

Heniochus macrolepidotus, Günther, Cat. II, 39 (Ceylon; Amboyna; Port Essington; Australia).

Taurichthys macrolepidotus, Bleeker, Atlas, IX, 29, pl. cc.c.LXVII, fig. 1. (Misprinted *microlepidotus* on plate.)

Heniochus acuminatus, Jordan & Evermann, Bull. U. S. Fish Comm., XXIII, pt. 1, 1903 (1905), 376, pl. LV (Honolulu).

Family PLATACIDÆ.

243. *Platax orbicularis* (Forskål). *Kiting*.

Two fine adults from Jolo (no. 4158 and 4159; length 6 and 6.5 in.). Anterior dorsal and anal rays greatly produced, those of dorsal exceeding total length of fish; ventrals very long, equaling length of fish to base of caudal.

Chætodon orbicularis Forskål, Deser. Anim., 59, 1779, Red Sea.

Chætodon vesperilio Bloch, Ichth., VI, 49, pl. cxcix, fig. 2, 1797.

Platax vesperilio, Day, Fishes India, 236, pl. LI, fig. 5. Bleeker, Atlas, IX, 74, pl. cc.c.LXXIX, fig. 1, and pl. cc.c.LXXX, figs. 2 and 3.

Platax orbicularis, Günther, Cat., II, 490 (Port Essington).

Family EPHIPPIDÆ.

244. *Ephippus argus* (Gmelin). *Pingao* (young); *Sarawolleta*.

Three specimens from Bacon (no. 4087 to 4089; length 5.5 to 6.75 in.), and 7 young from San Fabian (no. 3988; length 2 to 2.55 in.).

Chætodon argus Gmelin, Syst. Nat., 1248, 1788, Indies.

Scatophagus argus, Günther, Cat., II, 58 many localities; Day, Fishes India, 114, pl. XXIX, fig. 3.

Family ACANTHURIDÆ.

245. *Hepatus celebicus* (Bleeker).

One specimen from Bulan (no. 4122; length 6.75 in.). White ring obsolete.

Acanthurus celebicus Bleeker, Nat. Tijds. Ned. Ind., III, 1852, 761, Celebes; Günther, Cat., III, 339.

246. *Ctenochætus striatus* (Quoy & Gaimard). *Saliao*.

Two specimens from Zamboanga (no. 4120 and 4121; length 8.2 and 9.5 in.).

Acanthurus striatus Quoy & Gaimard, Voy. Uranie, Zool., 373, pl. 63, fig. 3, 1824, Guam; Günther, Cat., III, 334.

Ctenochætus striatus, Jordan & Evermann, Bull. U. S. Fish Comm., XXIII, pt. 1, 1903 (1905), 398 (Hilo; Honolulu; Kailua).

247. *Acanthurus unicornis* (Forskål).

One specimen (young) from San Fabian (no. 3960; length 2.5 in.).

Chatodon unicornis Forskål, Descr. Anim., 63, 1775, Djidda.

Acanthurus unicornis, Jordan & Evermann, Bull. U. S. Fish Comm., xxiii, pt. 1, 1903 (1905), 402 (Honolulu; Hilo; Puako Bay, Hawaii).

Family SIGANIDÆ.

248. *Siganus javus* (Linnæus).

Two specimens from Bulan (no. 4092 and 4093; length 9 and 10 in.). Head 4.1 in length; depth 2.18; snout 2.1 in head; eye 3.35. Dorsal XIII, 10; anal VII, 9.

Teuthis javus Linnæus, Syst. Nat., ed. XII, 507, 1766; Day, Fishes India, 165, pl. xxxix, fig. 5; Günther, Cat., III, 315 (Ceylon; Singapore; Amboyna; Hobson Bay).

Amphacanthus javus, Cuvier & Valenciennes, Hist. Nat. Poiss., x, 86 (118), (Pondicherry).

249. *Siganus fuscescens* (Houttuyn). *Palit*.

Apparently a very abundant species in the Philippines. The present collection contains 747 specimens from Bacon (no. 3382, 3622, 3623, 3923, 3924, 3440, 3500, 3501, 3502, 3513, 3851, 4006, 4007, 4143, 4144; length 1.5 to 8.5 in.), 2 from Jolo (no. 3518 and 3639), and 1 from San Fabian (no. 3864).

These have been carefully compared with specimens from Japan, Cavite, and Panay. They agree perfectly, even to the bars on the caudal.

Centrogaster fuscescens Houttuyn, Verh. Holl. Maat. Weet. Haarlem, xx, 1782, 333.

Amphacanthus fuscescens, Richardson, Ichth. China, 243, 1846.

Teuthis fuscescens, Günther, Cat., III, 321 (coast of Nagasaki).

250. *Siganus virgatus* (Cuvier & Valenciennes).

One specimen from Bacon (no. 3233; length 7.5 in.). Readily known by the bluish transverse lines on snout and interorbital and the oblique dark lines downward and forward from dorsal.

Amphacanthus virgatus Cuvier & Valenciennes, Hist. Nat. Poiss., x, 97 (133), 1835, Java.

Teuthis virgata, Günther, Cat., III, 323 (Philippines; China); Day, Fishes India, 166, pl. xl, fig. 3 (Andamans).

251. *Siganus vermiculatus* (Kuhl & Van Hasselt). *Pugut; Alama*.

Seven specimens from Zamboanga (no. 3251 to 3257; length 3.5 to 6.75 in.), 4 from Bacon (no. 3303 to 3306; length 3 to 4 in.), 3 from Philippines (no local label, no. 3800 to 3802; length 3 in.), and one very large specimen from San Fabian (no. 4037; length 11 in.).

Amphacanthus vermiculatus Kuhl & Van Hasselt in Cuvier & Valenciennes, Hist. Nat. Poiss., x, 92 (126), 1835, New Guinea.

Teuthis vermiculata, Günther, Cat., III, 317 (Philippines; Amboyna); Day, Fishes India, 166, pl. xl, fig. 1

252. *Siganus lineatus* (Cuvier & Valenciennes). *Samaral; Mororosa*.

Two from Bulan (no. 4056 and 4057; length 9.75 and 10.5 in.), and one from Bacon (no. 4039; length 10.2 in.).

Amphacanthus lineatus Cuvier & Valenciennes, Hist. Nat. Poiss., x, 95 (130), pl. 286, 1835, Vanicolo and New Guinea.

Teuthis lineata, Günther, Cat., III, 322.

253. *Lo unimaculatus* Evermann & Seale, new species.

Head 3.3 in length to base of caudal; depth 2.5; eye 4 in head; snout 1.9; opercle with a number of low thin vertical ridges; preopercle with somewhat similar oblique lines; lower edge of preopercle finely dentate; scales cycloid and very minute on body, the head nearly naked, having only a few scattered nonimbricated scales below eye and along side of snout; interorbital 3.75; pectoral 1.45; ventral scarcely shorter than pectoral; dorsal XIII, 10; anal VII, 9; ventral I, 3, I.

Body greatly compressed, elongate, the ventral and dorsal outlines nearly parallel from nuchal crest to base of twelfth dorsal spine; snout much produced, tubular, the maxillary 1.3 in eye; interorbital space but slightly convex; dorsal profile rising abruptly from behind the eye in a thin trenchant ridge; teeth in a single row, uniform in size, incisor-like, brown-tipped in the upper jaw, smaller and plain white in color in the lower, about

12 on each side in each jaw; origin of dorsal in vertical above base of pectoral, the first spine 1.6 in snout, the longest spine (the seventh) about equal to snout and half diameter of eye, the last spine equal to snout; origin of anal under base of seventh dorsal spine; first anal spine slightly longer than first spine of dorsal, the fourth spine slightly greater than snout; soft dorsal and soft anal pointed, the middle rays longest, about equal in the 2 fins and equaling the snout; caudal moderately forked, the lobes equal to snout and half eye; ventral not reaching origin of anal.

Color in alcohol, mottled brownish; snout, head and breast back to origin of dorsal and ventral fins rich brownish black, extending on side in a broad curve to middle of pectoral; interorbital space and side of head below eye paler; first dorsal spine black, the others yellowish white; first ray of pectoral black, rays of fin

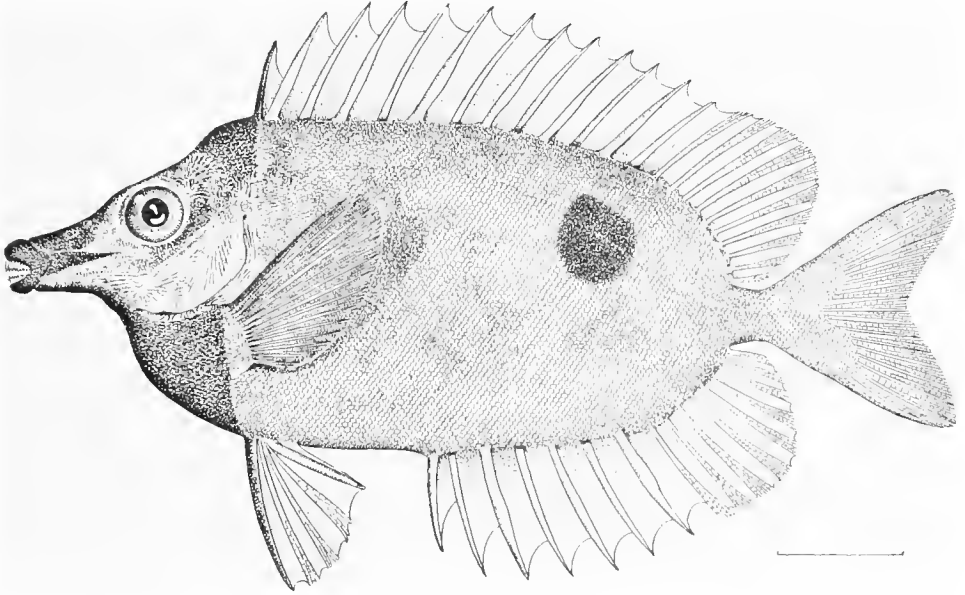

FIG. 19.—*Lo unimaculatus* Evermann & Seale, new species. Type.

whitish with some indistinct black blotches; skin of ventral spines blackish, rays of the fin white; soft dorsal and entire anal yellowish white, the spines of the latter with dark edges; caudal dusky along edges, otherwise yellowish white; a large round brownish black spot one-half larger than eye on lateral line under base of last 3 dorsal spines and first dorsal ray.

This species is related to *Lo vulpinis* (Schlegel & Müller), from which it differs in the more slender body and in the presence of the black lateral spot.

Only one specimen obtained, the type, no. 55915, U. S. National Museum (original no. 3538), 7.5 inches long, collected by Mr. Charles J. Pierson, at Bacon, Sorsogon, P. I.

Family BALISTIDÆ.

254. *Balistes niger* Mungo Park.

One specimen from Bacon (no. 3603; length 5.5 in.).

Balistes niger Mungo Park, Trans. Linn. Soc. Lond., III, 1797, 37, Sumatra; Günther, Cat., VIII, 218; Bleeker, Atlas, v, pl. CCXVI, fig. 1.

255. *Balistes flavimarginatus* Rüppell. *Pakol*.

One very large specimen (no. 4154; length 15 in.) from Bacon. Head 3 in length; depth 1.8; eye 5 in head; snout 1.2; interorbital 2.8; first dorsal spine 1.8; depth of caudal peduncle 3.5, its greatest width 5;

longest dorsal ray 1.75; longest anal ray 1.5; length of pectoral 2. Teeth very strong, the front ones conic; dermal plates strong and rough, 29 from gill-opening to base of caudal; preocular groove distinct.

Balistes flavimarginatus Rüppell, Atlas, Fische, 33, 1828. **Red Sea**; Günther, Cat., VIII, 223 (Red Sea; Amboyna).

Balistes (Pseudobalistes) flavimarginatus, Bleeker, Atlas, v, 113, pl. CCXXIV, fig. 3.

256. *Balistapus undulatus* (Mungo Park).

Nine specimens from Bacon (no. 3374, 3375, 3438, 3439, 3604, 4058 to 4060, and 4123; length 4.75 to 6.5 in.).

Balistes undulatus Mungo Park, Trans. Linn. Soc. Lond., III, 1797, 37, **Sumatra**; Günther, Cat., VIII, 226 (Red Sea; Zanzibar; Moluccas; Sumatra; Amboyna; Ceram; Zebu, Philippines; China; Japan).

Balistes (Balistapus) lineatus Bleeker, Atlas, v, 118, pl. CCXXIX, fig. 2.

257. *Balistapus aculeatus* (Linnæus). *Pugut*.

Nine specimens from Bacon (no. 3307, 3308, 3388, 3389, 3433 to 3435, 4118 and 4119; length 3.5 to 6.5 in.), and 2 from Zamboanga (no. 3364 and 3373).

Balistes aculeatus Linnæus, Syst. Nat., ed. x, 38, **India**; Günther, Cat., VIII, 223 (Ile de France; Island of Johanna; Zanzibar; Moluccas; Amboyna; China Seas; Fiji; Micronesia; Seychelles; Mauritius).

Balistapus aculeatus, Jordan & Evermann, Bull. U. S. Fish Comm., XXIII, 1903 (1905), 414, pl. LXII.

Family MONACANTHIDÆ.

258. *Monacanthus chinensis* (Bloch).

Three specimens from Bulan (no. 3259, 3260, and 4140; length 5 to 6.5 in.).

Balistes chinensis Bloch, Ichth., v, 24, pl. CLII, fig. 1, 1797, **Brazil and China**.

Monacanthus chinensis, Günther, Cat., VIII, 236 (North China; Pinang; Singapore; Shanghai); Bleeker, Atlas, v, 125, pl. CCXXII, fig. 2.

259. *Monacanthus macrurus* Bleeker. *Bungaong*.

One fine specimen from Jolo (no. 3693; length 7.5 in.), and one from Bacon (no. 3676; length 5.55 in.). These specimens show traces of dark bands at base of anal.

Monacanthus macrurus Bleeker, Nat. Tijds. Ned. Ind., XII, 226, 1857, **Nias**; Günther, Cat., VIII, 247, 1870.

Pseudomanacanthus macrurus Bleeker, Atlas, v, 134, pl. CCXXVIII, fig. 2.

260. *Osbeckia scripta* (Osbeck). *Samarang*.

Three specimens from Jolo (no. 3313 to 3315; length 4.5 to 8.2 in.). Color in spirits, yellowish with brown spots and reticulations; caudal 2.5 in length.

These specimens differ from typical examples of *O. scripta* in having the dorsal spine very short, its length being less than diameter of eye. They may represent an undescribed species, the describing of which we defer until additional material can be examined.

Balistes scriptus Osbeck, Reise nach Ostindien und China, 1, 144, 1765, **China Seas**.

Balistes monoceros scriptus, Gmelin, Syst. Nat., 1463, 1788; after Osbeck.

Monacanthus scriptus, Günther, Cat., VIII, 252.

Osbeckia scripta, Jordan & Evermann, Bull. U. S. Fish Comm., XXIII, 1903 (1905), 422, fig. 184 (Honolulu).

Family TETRAODONTIDÆ.

261. *Lagocephalus hypselogeneion* (Bleeker).

Three specimens from Bulan (no. 4023 to 4025; length 3.5 to 3.75 in.).

These examples have the fold of skin on lower posterior portion of side and tail well developed; caudal lunate and banded with numerous fine vertical lines; cheek with 5 subvertical bars of brown; upper half of body with numerous whitish spots. These seem to resemble Day's figure in every respect.

Tetraodon hypselogeneion Bleeker, Nat. Tijds. Ned. Ind., III, 300, 1852, **Amboyna, Wahai**.

Tetrodon hypselogeneion, Günther, Cat., VIII, 277; Day, Fishes India, 702, pl. CLXXXIII, fig. 5.

262. *Canthigaster bennetti* (Bleeker).

Four specimens from Bacon (no. 3749; length 1.25 to 1.75 in.).

Tropidichthys bennetti Bleeker, Nat. Tijds. Ned. Ind., vi, 504, Amboyna.

Tetrodon bennetti, Günther, Cat., viii, 301.

Canthogaster ocellatus Bleeker, Atlas, v, 80.

Ptilonotus ocellatus, Bleeker, Atlas, v, pl. cxxiv, fig. 5.

263. *Canthigaster compressus* (Procé).

Two specimens from Philippines (no local label, no. 4018; length 2.2 and 2.75 in.).

Tetrodon compressus Procé, Bull. Soc. Philom. 1822, 130, Manila.

Tetrodon striolatus, Günther, Cat., viii, 304.

Canthogaster striolatus, Bleeker, Atlas, v, 82.

Ptilonotus striolatus, Bleeker, Atlas, v, pl. cxxiii, fig. 6.

264. *Spheroides lunaris* (Bloch & Schneider). *Botete*.

One specimen from San Fabian (no. 4033; length 3.25 in.).

Tetrodon lunaris Bloch & Schneider, Syst. Ichth., 505, 1801, Malabar; Günther, Cat., viii, 274 (Philippines and many other places).

Spheroides lunaris, Jordan & Seale, Proc. U. S. Nat. Mus., xxviii, 1905, 790 (Negros).

265. *Tetraodon nigropunctatus* Bloch & Schneider. *Dole*.

One specimen from Bacon (no. 4062; length 8.5 in.). This example is uniform black, the spicules silvery white, short and developed only on belly, back, and sides; the caudal, cheeks, snout, chin, and a spot on the middle of back naked; fins black except pectorals which have a slight wash of yellowish.

Tetraodon nigro-punctatus Bloch & Schneider, Syst. Ichth., 507, 1801, Tranquebar.

Tetraodon nigropunctatus, Günther, Cat., viii, 233.

Crayracion nigropunctatus, Bleeker, Atlas, v, 74, pl. ccvi, fig. 4.

Family OSTRACIIDÆ.

266. *Ostracion tuberculatum* Linnæus.

One specimen from Jolo (no. 3764; length 1 in.).

Ostracion tuberculatum Linnæus, Syst. Nat., ed. x, 331, 1758, India.

Ostracion cubicus Linnæus, Syst. Nat., ed. x, 332, 1758, India; Günther, Cat., viii, 260 (Red Sea; Zanzibar; Seychelles; Mauritius; Ceylon; Amboyna; Ceram; South Australia).

267. *Ostracion gibbosum* Linnæus

One specimen from Jolo (no. 3853; length 2.4 in.).

Ostracion gibbosus Linnæus, Syst. Nat., ed. x, 332, 1758, India; Günther, Cat., viii, 258.

Ostracion turrinus Day, Fishes India, 695, pl. clxxxi, fig. 4.

Ostracion (Tetrosomus) turrinus, Bleeker, Atlas, v, 31, pl. ccm, fig. 3.

Family SCORPÆNIDÆ.

HYPOMACRUS Evermann & Seale, new genus.

Hypomacrus Evermann & Seale, new genus of Scorpenidæ (*Hypomacrus albaicasis*).

This genus is related to *Sebastopsis* Gill, from which it differs in having the tenth to thirteenth pectoral rays much produced. The upper 9 rays are subequal, their length half that of head; length of tenth ray 1.2 in head, the eleventh to thirteenth successively shorter, the last 3 usually shorter than the upper 9 and not detached. ($\delta\pi\alpha$, under; $\mu\alpha\kappa\rho\sigma$, long; referring to the produced lower pectoral rays.)

268. *Hypomacrus albaiensis* Evermann & Seale, new species.

Head 2.25 in length without caudal; depth 3.25; eye 3.75 in head; snout 3.75; interorbital 2 in snout; dorsal xii, 9 (the cotype has the soft dorsal deformed, with only 5 rays); anal iii, 5; scales 5-26-13, about 16 tubules in lateral line.

Body moderately compressed, the head rather elongate, the lower jaw projecting, depth of caudal peduncle 4.1 in head; maxillary 2 in head, the distal end under the posterior margin of pupil, its distal width 1.5 in eye; mandible 1.75 in head; villiform teeth on jaws and vomer, none on palatines; gillrakers very small, 8 on lower limb of first arch; spines of head as follows: opercular 2; preopercular 2, the upper the larger, with a small superimposed spine on its base; bony stay across cheek with 2 spines, 4 above eye, 5 on each side of nuchal region; a distinct fringed orbital tentacle equal in length to pupil; a short dermal flap at base of each nuchal spine; a branched flap at nostril, and a rather long preorbital flap hanging over maxillary.

Body entirely scaled, head scaled; origin of dorsal above axil of pectoral, longest spine 3.2 in head; origin of anal under origin of soft dorsal, its longest ray 2 in head, the second anal spine the longest and strongest, 2.3 in head; origin of ventrals about midway between tip of upper jaw and origin of anal, their length 1.85 in head, their tips falling far short of anal; pectoral peculiar, the 9 upper rays short, about 2 in head, their tips scarcely extending past tips of ventrals; the lower part of fin elongate, composed of 7 simple rays, the longest 1.19 in head, their tips beyond line with origin of anal fin; caudal rounded, 1.65 in head.

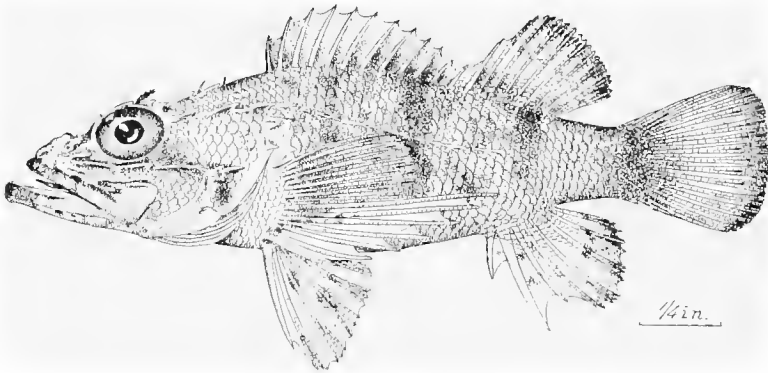

Fig. 20.—*Hypomacrus albaiensis* Evermann & Seale, new species. Type.

Color in spirits, mottled brownish, a large yellowish area occupying entire upper two-thirds of opercle, extending to eye anteriorly, and posteriorly extending down and covering base of pectoral; a round black opercular spot posterior of and between the preopercular spines; about 5 indistinct rather narrow dark bands over back; spinous dorsal with irregular dusky markings, soft dorsal with dark base and tip, the mid portion whitish; anal with irregular dark markings, the most distinctive being a black spot on posterior axil of fin; ventrals shaded with dusky dots posteriorly; pectoral with brown dots on the short rays, the elongate rays white with a few scattered brown dots; caudal dusky at tip, a slight dusky wash on base of rays.

Type, no. 55902, U. S. National Museum, original no. 3866 (10,771), 2.5 inches long, from Bacon, Sorsogon, P. I., collected by Mr. Charles J. Pierson. Cotype, no. 20,006, Stanford University, a specimen 2.25 inches long, also from Bacon.

269. *Sebastopsis scabra* (Ramsay & Ogilby).

One specimen from Bacon (no. 4004; length 2.75 in.).

Sebastes scaber Ramsay & Ogilby, Proc. Linn. Soc. N. S. W., X, 1885, 577, Shark Reef, Australia.

Sebastopsis scabra, Jordan & Seale, Proc. U. S. Nat. Mus., XXVIII, 1905 (July 3), 791 (Negros).

270. *Sebastopistes tristis* (Klunzinger).

Three specimens from Bacon (no. 3612 to 3614; length 4 to 4.5 in.). This species is close to *S. nigrifer* Jordan & Seale, described from Negros, P. I., differing in the orbital spines, the dermal flaps, and the color.

Scorpena tristis Klunzinger, Synop. Fische des Rothen Meers, Verh. Zool.-Bot. Gesellsch. Wien, XX, 1870, 802, Red Sea.

Scorpena bakeri Seale, Fishes of Guam, in Occ. Papers Bishop Mus., vol. I, no. 2, 1901, 120, Guam.

271. *Pterois volitans* (Linnaeus).

Two fine specimens from Bacon (no. 3444 and 3445; length 6.5 and 6.75 in.).

Gasterosteus volitans Linnaeus, Syst. Nat., ed. x, 296, 1758, **Amboyna**.

Pterois volitans, Günther, Cat., II, 122 (Egypt; South Africa; Cape of Good Hope; Madras; China; Amboyna).

Pseudomonopterus (Pterois) volitans, Bleeker, Atlas, IX, pl. ccccxii, fig. 3.

272. *Dendrochirus zebra* (Cuvier & Valenciennes).

Four specimens from Bacon (no. 3574 and 3577; length 3.5 to 4.75 in.).

Pterois zebra Cuvier & Valenciennes, Hist. Nat. Poiss., IV, 269 (367), 1829, **Ile de France**; Günther, Cat., II, 126 (Amboyna; China; Madagascar).

Pseudomonopterus (Dendrochirus) zebra, Bleeker, Atlas, IX, pl., ccccxI, fig. 1.

Family PLATYCEPHALIDÆ.

273. *Platycephalus bataviensis* Bleeker.

One specimen from Jolo (no. 3276; length 8 in.).

Platycephalus bataviensis Bleeker, Nat. Tijds. Ned. Ind., IV, 1853, 460, **Batavia**; Atlas, IX, pl. ccccxX, fig. 4; Günther, Cat., II, 188.

274. *Platycephalus insidiator* (Forskål). *Lacoy*.

On specimen from San Fabian (no. 3900; length 6.2 in.).

Cottus insidiator Forskål, Deser. Anim., 25, 1775, **Red Sea**.

Platycephalus insidiator, Günther, Cat., II, 177 (Calcutta; Ganges; China; Malayan Peninsula; Moluccas; Amboyna; Cape York; Australia; Red Sea; Port Natal; Cape of Good Hope).

275. *Platycephalus macracanthus* Bleeker. *Cacabit*.

One specimen from San Fabian (no. 3857; length 5.25 in.).

Platycephalus macracanthus Bleeker, Versl. Meded. Ak. Wet., 2d reeks, III, 1868-9, 253, **Amboyna**; Atlas, IX, pl. ccccxIX, fig. 1.

Family CALLIONYMIDÆ.

276. *Calliurichthys reevesii* (Richardson).

Four specimens from Bulan (no. 4077 to 4080; length 5.75 to 6.5 in.).

Callionymus reevesii Richardson, Voy. Sulphur, 60, pl. 36, figs. 1-3 (not 4), 1845, **Canton**.

Family NOTOTHENIIDÆ.

277. *Parapercis hexophthalma* (Ehrenberg).

One specimen from Bacon (no. 3721; length 6.2 in.).

Percis hexophthalma Ehrenberg in Cuvier & Valenciennes, Hist. Nat. Poiss., III, 202 (271), 1829, **Massuah**; Günther, Cat., II, 239 (Louisiade Archipelago; Red Sea).

Family OPHICEPHALIDÆ.

278. *Ophicephalus striatus* Bloch.

Five specimens from Philippines (without local label, no. 3791 to 3795; length 3.1 to 4 in.).

Ophicephalus striatus Bloch, Ichth., x, 117, pl. cccclIX, 1797, **East Indies**.

Ophiocephalus striatus, Günther, Cat., III, 474 (Loodianah; Ganges; Bengal; Pinang; Madras); Bleeker, Atlas, IX, pl. cccxcIX, fig. 1.

Family GOBIIDÆ.

279. *Butis leucurus* Jordan & Seale.

Three specimens from San Fabian (no. 3858 to 3860; length 3.5 to 4 in.), and one from Bacon (no. 3728; length 3.45 in.). Species originally described from Negros; other specimens collected at Cavite by Dr. Geo. A. Lung and forwarded to Stanford University.

Butis leucurus Jordan & Seale, Proc. U. S. Nat. Mus., xxviii, 1905 (July 3), 794, fig. 13, **Negros Island**.

280. *Glossogobius biocellatus* (Cuvier & Valenciennes).

Two specimens from Bacon (no. 3747 and 3745; length 3.5 and 3.75 in.). Close to *G. giuris*, but lower jaw less prominent, body more robust and head broader.

Gobius biocellatus Cuvier & Valenciennes, Hist. Nat. Poiss., xii, 55 (73), 1837, **Pondicherry**; Günther, Cat., iii, 20; Day, Fishes India, 289, pl. LXIII, fig. 8.

281. *Glossogobius giuris* (Buchanan-Hamilton). *Cacabit*.

Nine specimens from Bacon (no. 3725 to 3727, 3729, 3741 to 3744, and 3749; length 4 to 9 in.), one from San Fabian (no. 3760), and one from Bulan (No. 4128).

Gobius giuris Buchanan-Hamilton, Fishes of the Ganges, 51 and 366, pl. 33, fig. 15, 1822, **Ganges River**; Day, Fishes India, 294, pl. LXVII, fig. 1; Günther, Cat., iii, 21.

282. *Oxyurichthys cristatus* (Day).

One specimen from San Fabian (no. 3929; length 5.8 in.).

Euctenogobius cristatus Day, Proc. Zool. Soc. Lond. 1873, 109, **Bombay**.

Gobius cristatus Day, Fishes India, 291, pl. LXII, fig. 8.

283. *Valenciennesia strigata* (Broussonet).

Two specimens from Bacon (no. 3999; length 2.1 in.). Head 3 in length; depth 4.75; scales 150; dorsal vi-1, 18; anal i, 17; anterior dorsal rays elongate. Color white; a blue dark-edged band from angle of mouth to opercle, another indistinct band on preopercle.

Gobius strigatus Broussonet, Ichth., i, 1782, **Tahiti**.

Elotris strigata, Cuvier & Valenciennes, Hist. Nat. Poiss., xii, 189 (251); Günther, Cat., iii, 131 (Java; Amboyna; Celebes; Booro; Tahiti); Günther, Fische der Südsee, 190, pl. 111, fig. e.

Family BLENNIIDÆ.

284. *Salaria fasciatus* (Bloch).

Ten specimens from Bacon (no. 3974; length 1.2 to 4 in.).

Blennius fasciatus Bloch, Ichth., v, pl. CLXII, fig. 1, 1797.

Salaria fasciatus, Günther, Cat., iii, 244 (Borneo; Philippines; New Holland; Victoria Bank; Fiji Islands; Tonga Islands; Aneityum); Günther, Fische der Südsee, 201, pl. 115, fig. h.

285. *Petroscirtes grammistes* (Cuvier & Valenciennes).

Two specimens from Bacon (no. 3757; length 3.2 in.).

Blennechis grammistes Cuvier & Valenciennes, Hist. Nat. Poiss., xi, 210 (284), 1836, **Java**.

Petroscirtes ancema, Günther, Cat., iii, 236 (Amboyna; China); Günther, Fische der Südsee, pl. 115, fig. f.

Petroscirtes grammistes, Günther, Fische der Südsee, 197 (Yap; Kusaie; Amboyna).

Family ECHENEIDÆ.

286. *Echeneis naucrates* Linnæus.

One specimen from Bulan (no. 3740; length 10.5 in.).

Echeneis naucrates (misprint for *naucrates*) Linnæus, Syst. Nat., ed. x, 261, 1758, **Pelago Indico**; Günther, Cat., ii, 384 (many localities); Jordan & Evermann, Fishes North and Mid. Amer., 2269, 1898.

Family PLEURONECTIDÆ.

287. *Platophrys javanicus* (Bleeker). *Palad*.

One specimen from Bulan (no. 4049; length 8.25 in.). Anal 51; scales 71.

Rhombus javanicus Bleeker, Nat. Tijds. Ned. Ind., IV, 502, Batavia.

Pseudorhombus javanicus, Bleeker, Atlas, VI, 8, pl. CCXXXII, fig. 3; Günther, Cat., IV, 427 (Java); Day, Fishes India, 424, pl. XCII, fig. 2.

288. *Platophrys russellii* (Gray).

One specimen from Bulan (no. 4069; length 9 in.). Anal 59; scales 74.

Platessa russellii Gray, Ill. Ind. Zool., fig. 2.

Pseudorhombus russellii, Günther, Cat., IV, 424 (Umbilo River, Port Natal).

289. *Platophrys neglectus* (Bleeker). *Uguerangeray*.

Three specimens from San Fabian (no. 3390, 3619 and 3620; length 3.5 to 6.75 in.). Anal 57; scales 81.

Pseudorhombus neglectus Bleeker, Ned. Tijds. Dierk., III, 45, and Atlas, VI, 8, pl. CCXXXIV, fig. 1.

290. *Platophrys pantherinus* (Rüppell).

Two specimens from Bacon (no. 3409 and 3494; length 5.2 and 6 in.).

Rhombus pantherinus Rüppell, Atlas, 121, pl. 31, fig. 1, 1828, Red Sea.

Platophrys pantherinus, Bleeker, Atlas, VI, 11, pl. CCXXXIII, fig. 3; Day, Fishes India, 425, pl. XCII, figs. 3 and 4; Jordan & Evermann, Bull. U. S. Fish Comm., XXIII, 1903 (1905), 512.

Rhomboidichthys pantherinus, Günther, Cat., IV, 436 (Mauritius; Madagascar; Amboyna; Fiji).

291. *Platophrys palad* Evermann & Seale, new species. *Palad*.

Head 3.75 in length; depth 2.4; eye 6 in head; snout 4; maxillary 2.3, its distal end under middle of eye; dorsal 77; anal 60; scales 85; interorbital a very narrow trenchant ridge slightly higher than eye; jaws equal; canine teeth in anterior of jaws; gillrakers short and blunt, broader than long, 9 on lower limb, the curved

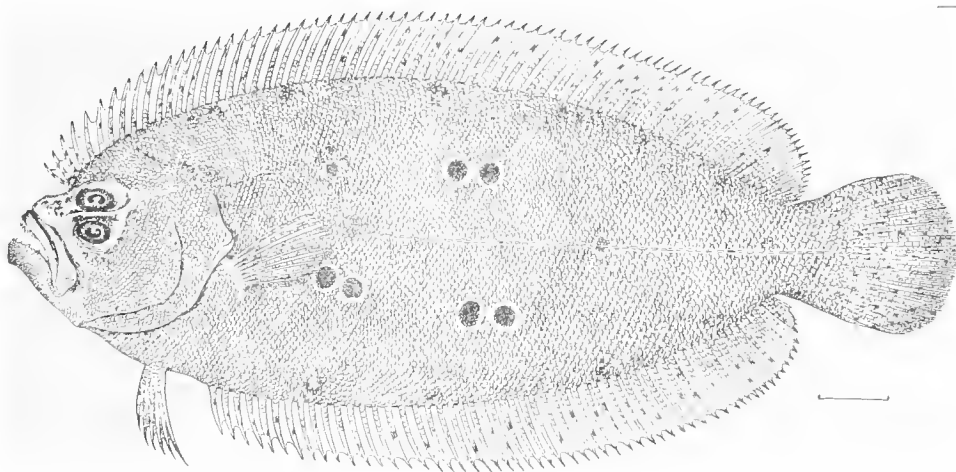

FIG. 21.—*Platophrys palad* Evermann & Seale, new species. Type.

portion of lateral line 3.5 in straight, the depth of the curve 3.1 in its length; longest dorsal ray 2.75 in head; longest anal ray 2.1 in head; colored pectoral 2 in head; caudal rounded, 1.25 in head. Color on left side.

Color in spirits, brownish; on each side of lateral line 2 large ocelli, each inclosing 2 large black spots; 2 very indistinct dusky blotches on the lateral line, one at posterior curve of lateral line, the other at the beginning

of posterior third of body; a row of indistinct ocelli at base of each vertical fin; numerous dusky dots and blotches on fins.

One large specimen from Bulan (no. 4050; length 15.5 in.). Type, no. 55898, U. S. National Museum, collected by Charles J. Pierson.

292. *Psettodes erumei* (Bloch & Schneider). *Uguerangueray*.

Two specimens from San Fabian (no. 3848 and 3849; length 4.75 and 6.5 in.). Head 3.6 in length; depth 2.5; eyes on right side. It may be that the sinistral specimens recorded by Günther and Bleeker are a different species.

Pleuronectes erumei Bloch & Schneider, Syst. Ichth., 150, 1801, "ad Tranquebarium."

Psettodes erumei, Günther, Cat., IV, 402 (China; Amboyna; Pinang; India); Day, Fishes India, 422, pl. xci, fig. 4; Bleeker, Atlas, VI, 4, pl. CCXXII, fig. 2.

Family SOLEIDÆ.

293. *Achirus hartzfeldii* Bleeker.

One specimen from "Philippine Islands" (no local label; no. 4012; length 4.5 in.). Anal 63; lateral line 98.

Achirus hartzfeldii Bleeker, Nat. Tijds. Ned. Ind., IV, 1853, 123, Amboyna; Atlas, VI, 25, pl. CCXLVI, fig. 1.

Aseraggodes hartzfeldii, Kaup, Archiv f. Naturgesch., jhg. XXIV, 1858, bd. I, 103.

Solca hartzfeldii, Günther, Cat., IV, 471 (Amboyna).

294. *Synaptura sorsogonensis* Evermann & Seale, new species.

Head 5.25 in length without caudal; depth 2.37; dorsal 74; anal 61; caudal 15; dorsal and anal continuous with caudal; pores of lateral line 141, of which 29 are in the short curved portion above the head; interorbital space scaled, scarcely greater than diameter of lower eye; upper eye covered by skin; the beaklike snout not extending around to a line with eye; upper nostril a distinct hollow papilla located in front of lower eye;

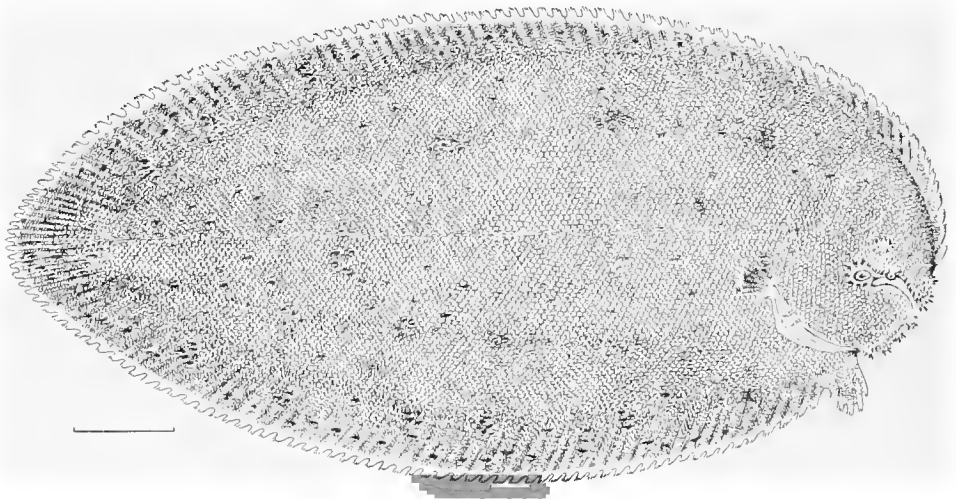

FIG. 22.—*Synaptura sorsogonensis* Evermann & Seale, new species. Type.

nostril of blind side greatly dilated and fringed; anterior part of head with numerous dermal fringes; dermal flaps scattered in groups over different portion of body, 4 such groups on lateral line and 4 on each side of body, alternating with the groups on lateral line; smaller groups along base of dorsal and anal fin; lateral line straight until it reaches head, where it makes a sharp curve ending on a line with anterior margin of upper eye; gillrakers obsolete; colored pectoral 3.75 in head; uncolored pectoral 4; dorsal beginning on snout in front of eyes, its middle ray 1.85 in head; middle anal ray 2 in head; colored ventral 2.9; caudal 1.3.

Color in spirits, brownish, the groups of dermal flaps described above blackish; colored pectoral black, tipped with white; margin of dorsal and anal white with a submarginal dusky area, more easily distinguished on under side.

This species is related to *S. pan*, but is distinguished by the greater number of rays and the dilated nostril.

One fine specimen from Bacon, Sorsogon, no. 4133 (10,825); length 9 in., type, no. 55916, U. S. National Museum, collected by Charles J. Pierson.

295. *Pardachirus pavoninus* (Lacépède).

One specimen from Bacon (no. 3383; length 5.5 in.). Anal 56; lateral line 100.

Achirus pavoninus Lacépède, Hist. Nat. Poiss., IV, 658 and 661; Bleeker, Atlas, VI, 24, pl. CCXLI, fig. 1.
Pardachirus pavoninus, Günther, Cat., IV, 479 (Pinang; Singapore; Moluccas).

296. *Soleichthys heterorhinus* (Bleeker).

One specimen from Bacon (no. 3927; length 4.2 in.). Anal 78; lateral line 112.

Solea heterorhinus Bleeker Visch fauna Amboina, 64, Act. Soc. Sc. Indo-Ned., I, 64, 1856, Amboyna.
Solea heterorhinus, Bleeker, Atlas, VI, 17.
Solea heterorhina, Günther, Cat., IV, 466 (Celebes, Amboyna); Bleeker, Atlas, VI, pl. CCXC, fig. 2; Day, Fishes India, 426, pl. XCII, fig. 5.

BIBLIOGRAPHY.

The following is a list of the published literature concerning the fishes of the Philippine Islands which has been consulted in connection with the preparation of this report. Besides these works we have consulted all of the numerous papers by Dr. Jordan and his collaborators on Japanese fishes:

1758. LINNÆUS, C. Systema naturæ per regna tria naturæ, secundum classes, ordines, genera, species, cum characteribus, differentiis, synonymis, locis. Editio decima, tomus I, p. 1-824.
1759. ———. Chinensia Lagerstromiana præside D. D. Car. Linnæo, Dec. 23, 1754. Amœnitates Academicæ, vol. IV, 1759, p. 230-260.
1765. OSBECK, PETER. Reise nach Ostindien und China, nebst O. Toreens Reise nach Suratte und C. G. Ekebergs Nachricht von der Landwirtschaft der Chineser, p. 1-XXIV+1-552, taf. 1-13. Aus dem schwedischen übersetzt von J. G. Georgi. Verleger Johann Christian Koppe. Rostock.
1766. LINNÆUS, C. Systema naturæ [etc.], ed. XII, t. I, Pisces, p. 419-532.
1774. FORSTER, JOHN REINHOLD. Descriptiones animalium quæ in itinere ad maris australis terras per annos 1772-74 suscepto [etc.]. Curante H. Lichtenstein, 8°, p. 1-XIII+1-425. Berolini, 1844.
1775. FORSKÅL, P. Descriptiones animalium, avium, amphibiorum, piscium, insectorum, vermium; quæ in itinere orientali observavit Petrus Forskål, p. 1-140. Post mortem auctoris edidit Carsten Niebuhr. Hauniæ.
1782. BROUSSONET, PIERRE MARIE AUGUSTE. Ichthyologia sistens piscium descriptiones et icones. Decas I, no pagination. London.
- 1785-1797. BLOCH, MARC ELIESER. Ichthyologie, ou histoire naturelle, générale et particulière des poissons, avec des figures enluminées, dessinées d'après nature. 12 t. in 6, 1684 p., pl. I-CCCCXXXII. Berlin.
1788. HOUTTUYN, M. Beschryving van enige japanse visschen, en andere zee-schepzelen. Verhandelingen, uitgegeeven door de Hollandsche Maatschappye der Weetenschappen, te Haarlem, xx. deels, 2. stuk, 1782, p. 311-350.
- . LINNÆUS, C. Systema naturæ [etc.], ed. XIII, aucta, reformata, cura J. F. Gmelin. 8°, t. I, pars III Pisces, p. 1126-1516. Lipsiæ, 1788-1793.
1792. THUNBERG, C. P. Åtskillige förut okände fiskar af Abbor-Slägtet. Kongl. Vetenskaps Academiens Nya Handlingar, n. s., t. XIII, 1792, p. 141-143.
1797. PARK, MUNGO. Descriptions of eight new fishes from Sumatra. Read November 4, 1794. Transactions of the Linnean Society of London, vol. III, 1797, p. 33-38.
1801. BLOCH, MARC ELIESER. Systema ichthyologiæ iconibus cx illustratum. Post obitum auctoris opus inchoatum absolvit, correxit, interpolavit Io Gottlob Schneider, Saxo. Berolini.
- . LACÉPÈDE, BERNHARD GERMAN ETIENNE, Comte de. Histoire naturelle des poissons. 5 t., 4°. Paris, 1798-1803.

1803. SHAW, GEORGE. General zoology, or Systematic natural history. Vol. iv, pt. II, Pisces, p. 187-632, 70 pl. London.
- RUSSELL, PATRICK. Descriptions and figures of two hundred fishes collected at Vizagapatam on the coast of Coromandel. 2 vol., fol. London.
1817. CUVIER, GEORGES. Le règne animal distribué d'après son organisation, pour servir de base à l'histoire naturelle des animaux et d'introduction à l'anatomie comparée, avec figures, dessinées d'après nature. T. II, contenant les reptiles, les poissons, les mollusques et les annélides, p. 1-532. [Poissons, p. 104-351.]
1822. BUCHANAN-HAMILTON, FRANCIS. An account of the fishes found in the river Ganges and its branches, p. 1-405, pl. 1-39 (atlas). 4°. Edinburgh.
- PROCÉ, MARION DE. Sur plusieurs espèces nouvelles des poissons et des crustacés observées par M. Marion de Procé. Bulletin des Sciences par la Société Philomathique de Paris 1822, p. 129-134.
1824. QUOY, JEAN RENÉ CONSTANT, et GAIMARD, PAUL. Voyage autour du monde, entrepris par ordre du roy, exécuté sur les corvettes de S. M. *l'Uranie* et la *Physicienne* pendant les années 1817, 1818, 1819 et 1820, par M. Louis de Freycinet, commandant de l'expédition. Zoologie par MM. Quoy et Gaimard, médecins de l'expédition, p. 1-712. [Poissons, p. 183-401.] Paris.
1828. RÜPPELL, EDUARD. Atlas zu der Reise im nördlichen Afrika, abth. 4, Fische des rothen Meers, 144 p., 35 pl.
- 1828-49. CUVIER, GEORGES, et VALENCIENNES, A. Histoire naturelle des poissons, 22 t., 4°, 8337 p., pl. I-VIII + 9-650. Paris. T. II published in 1828: III, 1829; IV, 1829; V, 1830; VI, 1830; VII, 1831; VIII, 1831; IX, 1835; XI, 1836; XII, 1837; XIII, 1839; XIV, 1839; XIX, 1846.
1829. CUVIER, GEORGES. Le règne animal distribué d'après son organisation, pour servir de base à l'histoire naturelle des animaux, et d'introduction à l'anatomie comparée, avec figures dessinées d'après nature. Nouvelle édition, revue et augmentée, t. II, p. 1-406. [Poissons, p. 122-406.]
- 1830-34. GRAY, JOHN EDWARD. Illustrations of Indian zoology; chiefly selected from the collection of Major-General Hardwicke. 2 vol. fol., London.
1831. BENNETT, E. T. An exhibition of the collection of fishes formed at the Mauritius by Mr. Telfair. Proceedings of the Committee of the Zoological Society of London, vol. 1, 1831 (Aug. 23), p. 126-128.
1832. VALENCIENNES, A. Descriptions de plusieurs espèces nouvelles de poissons du genre Apogon. Nouvelles Annales du Muséum d'Histoire Naturelle, t. 1, 1832, p. 51-60, pl. 4.
1838. RÜPPELL, EDUARD. Neue Wirbelthiere, zu der Fauna von Abyssinien gehörig, entdeckt und beschrieben von Dr. Eduard Rüppell. Fische des rothen Meers, p. 1-148, pl. 1-33, 1835.
1839. LAY, G. T., and BENNETT, E. T. Zoology of Captain Beechey's voyage; compiled from the collection and notes made by Captain Beechey, the officers and naturalist of the expedition, during a voyage to the Pacific and Bering's Straits performed in His Majesty's ship *Blossom* in the years 1825, 1826, 1827, and 1828. Fishes, p. 41-75, pl. XVI-XXIII.
- 1842-1850. TEMMINCK, C. J., and SCHLEGEL, H. Fauna japonica, Pisces, p. 1-524, pl. I-CXLIII. P. 1-20 published in 1842; 21-72 in 1843; 73-112 in 1844; 113-172 in 1845; 173-269 in 1846; 270-324 in 1850.
1845. RICHARDSON, SIR JOHN. The zoology of the voyage of the *Sulphur*, under the command of Sir Edward Belcher, during the years 1836-42, 2 vol. in one, 8°. London, 1844. Edited and superintended by R. B. Hinds. Ichthyology, p. 51-150, pl. 35-64, 1845.
1846. ———. Report on the ichthyology of the seas of China and Japan. Report of the fifteenth meeting of the British Association for the Advancement of Science, held at Cambridge June, 1846. p. 187-326.
1849. BLEEKER, P. A contribution to the knowledge of the ichthyological fauna of Celebes. Journal of the Indian Archipelago and eastern Asia, vol. III, 1849, p. 65-74.
- 1849-1854. ———. In Verhandelingen van het Bataviaasch Genootschap van Kunsten en Wetenschappen (articles pagéd independently):
 Bijdrage tot de kennis der ichthyologische fauna van Bali. 11 p. in deel XXII, 1849.
 Bijdrage tot de kennis der sparoiden van den Soenda-Molukschen Archipel. 16 p., XXIII, 1850.
 Bijdrage tot de kennis der haringachtige visschen van den Soenda-Molukschen Archipel. 52 p., XXIV, 1852.
 Bijdrage tot de kennis der makreelachtige visschen van den Soenda-Molukschen Archipel. 93 p., XXIV.
 Nieuwe nalezingen op de ichthyologie van Japan. 132 p., pl. I-VI, deel XXVI, 1854.

- 1849-1858. BLEEKER, P. In *Natuurkundig Tijdschrift voor Nederlandsch Indië*:
 Fauna ichthyologicae Javae insularumque adjacentium, Genera et species novae (I). Deel I,
 1850, p. 98-108.
 Ueber einige nieuwe geslachten en soorten van makreelachtige visschen van den indischen
 archipel. I, 1850, 341-372.
 Visschen van Billiton. I, 1850, 478-479.
 Nieuwe bijdrage tot de kennis der Percoiden, Scleroparcei, Sciaenoxdei, Sparoidei, Mannoidei,
 Chaetodontoiden en Scomberoiden van den Soenda-Molukschen Archipel. II, 1851, 163-179.
 Bijdrage tot de kennis der ichthyologische fauna van de Banda-Eilanden. II, 1851, 225-261.
 Bijdrage tot de kennis der ichthyologische fauna van Riouw. II, 1851, 469-497.
 Bijdrage tot de kennis der ichthyologische fauna van de Moluksche Eilanden. Visschen van
 Amboina en Ceram. III, 1852, 229-309.
 Bijdrage tot de kennis der ichthyologische fauna van het eiland Banka. III, 1852, 443-460.
 Nieuwe bijdrage tot de kennis der ichthyologische fauna van het eiland Banka. III, 1852,
 715-738.
 Derde bijdrage tot de kennis der ichthyologische fauna van Celebes. III, 1852, 739-782.
 Derde bijdrage tot de kennis der ichthyologische fauna van Amboina. IV, 1853, 91-130.
 Bijdrage tot de kennis der ichthyologische fauna van Ternate. IV, 1853, 131-140.
 Diagnostische beschrijvingen van nieuwe weinig bekende vischsoorten van Sumatra. IV, 1853,
 243-302.
 Diagnostische beschrijvingen van nieuwe weinig bekende vischsoorten van Batavia. IV, 1853,
 451-516.
 Nieuwe bijdrage tot de kennis der ichthyologische fauna van Ternate en Halmheira (Gilolo).
 IV, 1853, 595-610.
 Bijdrage tot de kennis der ichthyologische fauna van Solor. V, 1853, 67-96.
 Derde bijdrage tot de kennis der ichthyologische fauna van Ceram. V, 1853, 233-248.
 Vierde bijdrage tot de kennis der ichthyologische fauna van Amboina. V, 1853, 317-352.
 Nieuwe tientallen diagnostische beschrijvingen van nieuwe weinig bekende vischsoorten van
 Sumatra. V, 1853, 495-534.
 Fauna ichthyologicae japonicae species novae. VI, 1854, 395-426.
 Vijfde bijdrage tot de kennis der ichthyologische fauna van Amboina. VI, 1854, 454-508.
 Vijfde bijdrage tot de kennis der ichthyologische fauna van Celebes. VII, 1854, 225-260.
 Bijdrage tot de kennis der ichthyologische fauna van Batjan. VII, 1854, 359-378.
 Zesde bijdrage tot de kennis der ichthyologische fauna van Amboina. VIII, 1855, 391-434.
 Tweede bijdrage tot de kennis der ichthyologische fauna van Halmheira (Gilolo). IX, 1855,
 105-112.
 Achste bijdrage tot de kennis der ichthyologische fauna van Celebes. IX, 1855, 281-314.
 Bijdrage tot de kennis der ichthyologische fauna van het eiland Groot Obij. IX, 1855, 431-438.
 Bijdrage tot de kennis der ichthyologische fauna van het eiland Nias. XII, 1856, 211-228.
 Bijdrage tot de kennis der ichthyologische fauna van de Singi-Eilanden. XIII, 1857, 369-380.
 Derde bijdrage tot de kennis der ichthyologische fauna van Bali. XVII (vierde serie, deel III)
 1858-59, 141-175.
1850. CANTOR, THEODORE. Catalogue of Malayan fishes. *Journal of the Asiatic Society of Bengal*, vol. XVIII,
 pt. II, July-December, 1849, p. I-XII+983-1443, pl. I-XIV. Calcutta.
- 1856-57. BLEEKER, P. In *Verhandelingen der Natuurkundige Vereeniging in Nederlandsch Indië, or Acta
 Societatis Scientiarum Indo-Nederlandicae* (articles pagged independently):
 Beschrijvingen van nieuwe en weinig bekende vischsoorten van Amboina, 76 p. in vol. I, 1857.
 Beschrijvingen van nieuwe weinig bekende vischsoorten van Manado en Makassar, 80 p., I, 1856.
 Achste bijdrage tot de kennis der vischfauna van Amboina, 100 p., II, 1857.
1858. KAUP, J. Uebersicht der Soleinae der vierten Subfamilie der Pleuronectidae. *Archiv für Natur-
 geschichte*, jhg. XXIV, bd. I, 1858, p. 94-104.
- 1859-1870. GÜNTHER, ALBERT. Catalogue of the fishes in the collections of the British Museum. Vol. I, 1859;
 II, 1860; III, 1861; IV, 1862; V, 1864; VI, 1866; VII, 1868; VIII, 1870
1861. BLEEKER, P. Iets über de geslachten der Scaroiden en hunne Indisch-Archipelagische soorten.
 Verslagen en Mededeelingen der Koninklijke Akademie van Wetenschappen, afd. Natuurkunde,
 deel XII, 1861, p. 228-244. Amsterdam.
- 1861-1877. ———. Atlas ichthyologique des Indes Orientales Néerlandaises, t. I-IX, 1246 p., pl. I-CCCLXX.
 Fol., Amsterdam. T. I, published 1862; II, 1866; III, 1863; IV, 1864; V, 1865; VI, 1866-1872; VII,
 1873-1876; VIII, 1876-1877; IX (unfinished), 1877.
1865. ———. Description de quelques espèces inédites des genres *Pseudorhombus* et *Platophrys* de l'Inde
 Archipelagique. *Nederlandsch Tijdschrift voor de Dierkunde*, deel III, 1865, p. 43-50. Amsterdam.
1868. PETERS, W. Ueber die von Hrn. Dr. F. Jagor in dem ostindischen Archipel gesammelten und dem
 Königlichen Zoologischen Museum übergebenen Fische. *Monatsberichte der Königlichen Preus-
 sischen Akademie der Wissenschaften zu Berlin*, 1868, p. 254-281

1869. BLEEKER, P. Description et figure d'une espèce inédite de *Platycephale* (Dec., 1867). Verslagen en Mededeelingen der Koninklijke Akademie van Wetenschappen, afd. Natuurkunde, 2de reeks, deel III, 1868-1869, p. 253-254.
1870. KLUNZINGER, CARL BENJAMIN. Synopsis der Fische des rothen Meers, 1. theil. Verhandlungen der K. K. Zoologisch-Botanische Gesellschaft zu Wien, bd. XX, 1870, p. 669-834.
1871. GÜNTHER, ALBERT. Report on several collections of fishes recently obtained for the British Museum. Proceedings of the Zoological Society of London, 1871, p. 652-675, pl. LIII-LXX.
1873. BLEEKER, P. Révision des espèces Indo-Archipélagiques du genre *Lethrinus*. Nederlandsch Tijdschrift voor de Dierkunde, deel IV, 1873, p. 318-344.
- . Révision des espèces Indo-Archipélagiques des genres *Plectorhynchus* et *Pristipoma*. Nederlandsch Tijdschrift voor de Dierkunde, deel IV, 1873, p. 273-317.
- . DAY, FRANCIS. On some new or imperfectly known fishes of India and Burma. Proceedings of the Zoological Society of London, 1873, p. 107-112.
- 1873-1881. GÜNTHER, ALBERT. Fische der Südsee. Bd. I, p. 1-128, taf. 1-83, 1873-1875; bd. II, p. 129-256, taf. 84-140, 1876-1881. Journal des Museum Godeffroy, 1873-1881. Hamburg.
1878. DAY, FRANCIS. The fishes of India; being a natural history of the fishes known to inhabit the seas and fresh waters of India, Burma, and Ceylon. Vol. I, text, including Supplement, p. 1-xx+1-816; vol. II, Atlas, containing 198 plates. London, printed for the author, 1878-1888.
1885. RAMSAY, E. PIERSON and DOUGLAS-OCILBY, J. Descriptions of new or rare Australian fishes. Proceedings of the Linnean Society of New South Wales, vol. X, 1885, p. 575-579.
1895. PALACKÝ, J. Die Verbreitung der Fische, p. 1-239. Prag.
- . ELERA, CASTRO DE. Catálogo sistemático de toda la fauna de Filipinas. I, Vertebrados, p. 1-701. [Pisces, p. 45-621.] Manila.
- . BOULENGER, GEORGE ALBERT. Catalogue of the perciform fishes in the British Museum, 2d ed., vol. I, containing Centrarchidæ, Percidæ, and Serranidæ (part), p. 1-291, pl. I-XV. London.
- 1896-1900. JORDAN, DAVID STARR, and EVERMANN, BARTON WARREN. Fishes of North and Middle America, published as Bulletin of the U. S. National Museum No. 47, pt. I-IV, p. 1-3313, pl. I-cccxcii. Pt. I issued 1896; II and III, 1898; IV, 1900.
1901. SMITH, HUGH M. Notes on five food-fishes of Lake Buhi, Luzon, Philippine Islands. Bulletin of the U. S. Fish Commission, vol. XXI, 1901, p. 167-171, 3 fig.
1902. SMITH, HUGH M. The smallest known vertebrate. Science, n. s., vol. XV, p. 30-31, Jan. 3, 1902.
- . JORDAN, DAVID STARR, and EVERMANN, BARTON WARREN. Notes on a collection of fishes from the Island of Formosa. Proceedings U. S. National Museum, vol. XXV, 1902, p. 315-368, figs. 1-29.
1903. BRYAN, WM. ALANSON, and HERRE, ALBERT C. Annotated list of the Marcus Island fishes. Occasional Papers of the Bernice Pauahi Bishop Museum of Polynesian Ethnology and Natural History, Director's Report for 1902 (1903), vol. II, no. I, p. 125-139.
1904. FOWLER, HENRY W. A collection of fishes from Sumatra. Journal of the Academy of Natural Sciences Philadelphia, 2d ser., vol. XII, 1904 (June 10), p. 495-560, pl. VII-XXVIII.
- . New, rare or little-known Scombroids. Proceedings of the Academy of Natural Sciences Philadelphia 1904, p. 757-771.
1905. JORDAN, DAVID STARR, and SEALE, ALVIN. List of fishes collected by Dr. Bashford Dean on the island of Negros, Philippines. Proceedings U. S. National Museum, vol. XXVIII, 1905, p. 769-803, fig. 1-20.
- . and EVERMANN, BARTON WARREN. The shore fishes of the Hawaiian Islands, with a general account of the fish fauna. Bulletin of the U. S. Fish Commission, vol. XXIII, pt. I, 1903 (July 29, 1905), p. 1-574, col. pl. I-LXXV, bl. and wh. pl. 1-65, text fig. 1-229.
1906. SMITH, HUGH M., and SEALE, ALVIN. Notes on a collection of fishes from the Island of Mindanao, Philippine Archipelago, with descriptions of new genera and species. Proceedings of the Biological Society of Washington, vol. XIX, 1906 (June 4), p. 73-82.
- . JORDAN, DAVID STARR, and SEALE, ALVIN. The fishes of Samoa. Description of the species found in the archipelago, with a provisional check-list of the fishes of Oceania. Bulletin U. S. Bureau of Fisheries, vol. XXV, 1905 (Dec. 15, 1906), p. 173-455, pl. XXXIII-LIII, text fig. 1-104.
- . Fishes of the islands of Luzon and Panay. Bulletin of the U. S. Bureau of Fisheries, vol. XXVI, 1906, p. —.
- . EVERMANN, BARTON W., and SEALE, ALVIN. Fishes collected in the Philippine Islands by Maj. Edgar A. Mearns, Surgeon, U. S. Army. Proceedings U. S. National Museum, vol. XXXI, 1906, p. 505-512.

INDEX.

	Page		Page.
Abudefduf antjerius.....	93	armatus, Caranx.....	65
bankieri.....	92	Atherinidæ.....	59
curacao.....	93	Atherina forskalii.....	59
cyaneus.....	92	lacunosa.....	59
glaucus.....	93	temminckii.....	59
septemfasciatus.....	93	auriga, Chaetodon.....	96
unimaculatus.....	93	auritum, Cbærops.....	95
xanthurus.....	92	baconensis, Xystema.....	69
zonatus.....	92	baillonii, Trachinotus.....	66
Acanthuridæ.....	97	balinensis, Callyodon.....	96
Acanthurus unicornis.....	98	Balistapus aculeatus.....	100
Achirus hartzfeldii.....	106	undulatus.....	100
aculeatus, Balistapus.....	100	Balistes flavimarginatus.....	99
acuminatus, Heniochus.....	97	niger.....	99
Aeoliscus strigatus.....	57	Balistidæ.....	99
afer, Gymnothorax.....	56	bankieri, Abudefduf.....	92
affinis, Caranx.....	64	bartherinus, Pseudupeneus.....	88
albaiensis, Hypomacrus.....	102	bataviensis, Platycephalus.....	103
alexanderæ, Pomacentrus.....	90	belengeri, Johnius.....	87
altivelis, Cromileptes.....	78	Belonidæ.....	58
Ambassidæ.....	75	bennetti, Canthigaster.....	101
Ambassis lungi.....	75	biaculeatus, Gasterotokeus.....	57
nrotænia.....	75	bifasciatus, Pseudupeneus.....	88
amboinensis, Lutianus.....	81	bilineatum, Scolopsis.....	84
Amia chrysopoma.....	72	biocellatus, Glossogobius.....	104
endekataenia.....	73	bleekeri, Archamia.....	75
fasciata.....	72	Blenniidæ.....	104
frænata.....	71	boenack, Cephalopholis.....	77
hartzfeldi.....	72	boops, Caranx.....	63
jenkinsi.....	73	brachysomus, Scomber.....	61
koilomatodon.....	71	brevis, Caranx.....	65
margaritophora.....	74	bulanensis, Scolopsis.....	85
monochrous.....	72	Butis leucurus.....	104
novæ-guinæe.....	72	Cæcio cærolaurens.....	83
quadrifasciata.....	71	chrysozona.....	83
sangiensis.....	72	cuning.....	83
savayensis.....	72	calamara, Sparus.....	86
anchorago, Cherops.....	95	calcariferum, Plectropoma.....	78
Anchovia indica.....	54	Callionymidæ.....	103
Anguilla mauritiana.....	56	Calliurichthys reevesi.....	103
anguillaris, Plotosus.....	56	Callyodon balinensis.....	96
Anguillidæ.....	56	laeerta.....	96
Anodontostoma chacunda.....	54	oktodon.....	96
antjerius, Abudefduf.....	93	quoyi.....	96
Apogonichthyidæ.....	71	Calotomus genivirgatus.....	95
Apogonichthys mentalis.....	74	canadus, Raclycenatron.....	61
Archamia bleekeri.....	75	cancellatum, Scolopsis.....	81
macropteroides.....	74	cavinus, Pentapus.....	84
argenteus, Monodactylus.....	71	Canthigaster bennetti.....	101
Otolithus.....	87	compressus.....	101
argus, Ephippus.....	97	Carangidæ.....	62
argyrophanes, Saurida.....	54	Caranx affinis.....	64

	Page.		Page.
Caranx armatus	65	Echeneidæ	104
boops	63	Echeneis naucrates	104
brevis	65	edentula, Leiognathus	69
cynodon	64	edwardsi, Leiognathus	68
djeddaba	65	eleræ, Corythoichthys	57
freeri	63	Elopidæ	53
kalla	65	Elops saurus	53
ophthalmotenia	64	Emmelichthys leucogrammicus	71
sexfasciatus	65	endekatania, Amia	73
speciosus	64	Engraulidæ	54
celebicus, Hepatus	97	Epinephelus fasciatus	75
Plectorhynchus	84	maculatus	76
Centrisidæ	57	merra	75
Cephalopholis boenack	77	tauvina	75
kendalli	76	Ephippidæ	97
obtusauris	77	Ephippus argus	97
pachycentron	76	Equulidæ	67
ehacunda, Anodontostoma	54	erumei, Psetodes	106
Chætodon auriga	96	erythropterus, Lutianus	80
falcula	96	Exocoetidæ	58
octofasciatus	96	falcula, Chætodon	96
selene	96	fasciata, Amia	72
unimaculatus	97	fasciatus, Cheilinus	93
vagabundus	96	Epinephelus	75
Chætodontidæ	96	Leiognathus	69
Cheilinus chlorurus	93	Salaria	104
fasciatus	93	Fistularia petimba	56
Cheilio inermis	93	serrata	57
chinensis, Monacanthus	100	Fistulariidæ	56
Chirocentridæ	53	flavimarginatus, Balistes	99
Chirocentrus dorab	53	forskali, Atherina	59
ehlorurus, Cheilinus	93	frænata, Amia	71
Cherops anchorago	95	freeri, Caranx	63
auritum	95	fulviflamma, Lutianus	79
chrysopoma, Amia	72	furvicaudatus, Lutianus	80
chrysotænia, Plectorhynchus	84	fuscescens, Siganus	98
chrysozona, Cæcio	83	Gasterotokeus biaculeatus	57
Citula halli	65	Gazza minuta	69
Clupeidæ	53	tapeinosoma	69
clupeoides, Sardinella	54	genistriatus, Cadotomus	95
cœruleopunctatus, Scarichthys	95	Gerridæ	69
compressus, Canthigaster	101	gibbosum, Ostracion	101
cordyla, Megalaspis	65	gibbus, Lutianus	80
cornutus, Holocentrus	60	giganteus, Tylosurus	58
Corythoichthys eleræ	57	gilberti, Myctophum	55
cristatus, Oxyurichthys	104	giuris, Glossogobius	104
Cromileptes altivelis	78	glauus, Abudedefduf	93
Ctenocheatus striatus	97	Glossogobius biocellatus	104
cuning, Cæcio	83	giuris	104
curacao, Abudedefduf	93	Gobiidæ	104
cyanus, Abudedefduf	92	goldmanni, Plectorhynchus	84
cynodon, Caranx	64	gracilis, Saurida	54
eyprinoides, Megalops	53	gracilis, Stoleporus	53
Cypsilurus simus	58	Grammistes sexlineatus	78
Decapterus kurra	63	grammistes, Petroscirtes	104
macrosonus	63	guttatus, Halichoeres	94
deussatus, Lutianus	79	Gymnoceanius lethrinoides	81
delicatulus, Stoleporus	53	Gymnosarda pelamis	61
dendrochirus zebra	103	Gymuothorax afer	56
Diacope sebæ	78	richardsoni	56
dispar, Zenarchopterus	59	Hæmulidæ	83
djeddaba, Caranx	65	Halichoeres guttatus	94
dorab, Chirocentrus	53	leparensis	95
Dorosomatidæ	54	miniatus	94
dussumieri, Leiognathus	67	nigrescens	94
Umbrina	87	pœcilus	95
dussumierii, Hyporhamphus	58	purpurescens	94

Page.		Page.
	<i>Halichoeres scapularis</i>	94
	<i>halli</i> , Citula	65
	<i>hamrur</i> , <i>Priacanthus</i>	78
	<i>barak</i> , <i>Lethrinus</i>	86
	<i>Harengula moluccensis</i>	53
	<i>hartzfeldi</i> , <i>Amia</i>	72
	<i>hartzfeldii</i> , <i>Achirus</i>	106
	<i>haumela</i> , <i>Trichurus</i>	62
	<i>Hemiramphus marginatus</i>	58
	<i>Heniochus acuminatus</i>	97
	<i>Hepatus celebicus</i>	97
	<i>heterorhinos</i> , <i>Solcichthys</i>	107
	<i>hexophthalma</i> , <i>Parapereis</i>	103
	<i>hoevenii</i> , <i>Ilisha</i>	54
	<i>Holocentridæ</i>	60
	<i>Holocentrus cornutus</i>	60
	<i>Hyporhamphus dussumieri</i>	58
	<i>quoyi</i>	58
	<i>Hypomacrus</i>	101
	<i>albaensis</i>	102
	<i>hypselogeneion</i> , <i>Lagocephalus</i>	100
	<i>hypselopterus</i> , <i>Lethrinus</i>	86
	<i>Ilisha hoevenii</i>	54
	<i>indica</i> , <i>Anchovia</i>	54
	<i>indicus</i> , <i>Pseudupeneus</i>	88
	<i>inermis</i> , <i>Cheilodactylus</i>	93
	<i>insidiator</i> , <i>Platycephalus</i>	103
	<i>japonicus</i> , <i>Mulloidichthys</i>	88
	<i>Nemipterus</i>	82
	<i>Scomber</i>	61
	<i>jarbua</i> , <i>Terapon</i>	83
	<i>javanicus</i> , <i>Platypodus</i>	105
	<i>javus</i> , <i>Siganus</i>	98
	<i>jello</i> , <i>Sphyræna</i>	59
	<i>jenkinsi</i> , <i>Amia</i>	73
	<i>jerdoni</i> , <i>Pomacentrus</i>	89
	<i>johnii</i> , <i>Lutianus</i>	79
	<i>Johnius belengeri</i>	87
	<i>kalla</i> , <i>Caranx</i>	65
	<i>kapas</i> , <i>Xystodes</i>	70
	<i>kendalli</i> , <i>Cephalopholis</i>	76
	<i>koilomatodon</i> , <i>Amia</i>	71
	<i>Konosirus thrissa</i>	54
	<i>kurra</i> , <i>Decapterus</i>	63
	<i>Labracinus melanotænia</i>	95
	<i>trispilos</i>	95
	<i>Labridæ</i>	93
	<i>Labroides paradisens</i>	94
	<i>lacerta</i> , <i>Callyodon</i>	96
	<i>Lactarius lactarius</i>	63
	<i>lactarius</i> , <i>Lactarius</i>	63
	<i>lacunosa</i> , <i>Atherina</i>	59
	<i>Lagocephalus hypselogeneion</i>	100
	<i>langsar</i> , <i>Sphyræna</i>	60
	<i>Leognathus dussumieri</i>	67
	<i>edentula</i>	69
	<i>edwardsi</i>	68
	<i>fasciatus</i>	69
	<i>splendens</i>	67
	<i>stercorarius</i>	67
	<i>virgatus</i>	67
	<i>leiuroides</i> , <i>Tylosurus</i>	58
	<i>leparensis</i> , <i>Halichoeres</i>	95
	<i>Lepidaplois mesothorax</i>	94
	<i>lethrinoides</i> , <i>Gymnocranius</i>	81
	<i>Lethrinus barak</i>	86
	<i>hypselopterus</i>	86
	<i>Lethrinus mahsenoides</i>	87
	<i>moansii</i>	86
	<i>neumatocanthus</i>	86
	<i>richardsoni</i>	86
	<i>ornatus</i>	87
	<i>variegatus</i>	86
	<i>leucogrammicus</i> , <i>Emmelichthys</i>	71
	<i>leucurus</i> , <i>Butis</i>	104
	<i>lineatus</i> , <i>Lutianus</i>	81
	<i>Siganus</i>	98
	<i>lineolatus</i> , <i>Lutianus</i>	81
	<i>littoralis</i> , <i>Pomacentrus</i>	89
	<i>Lo unimaculatus</i>	98
	<i>lunaris</i> , <i>Spheroides</i>	101
	<i>Thalassoma</i>	94
	<i>lungi</i> , <i>Ambassis</i>	75
	<i>lunulatus</i> , <i>Lutianus</i>	80
	<i>luteus</i> , <i>Pseudupeneus</i>	89
	<i>Lutianidæ</i>	78
	<i>Lutianus amboinensis</i>	81
	<i>decussatus</i>	79
	<i>erythropterus</i>	80
	<i>fulviflamma</i>	79
	<i>furvicanthus</i>	80
	<i>gibbus</i>	89
	<i>johnii</i>	79
	<i>lineatus</i>	81
	<i>lineolatus</i>	81
	<i>lunulatus</i>	80
	<i>luzonius</i>	79
	<i>malabaricus</i>	81
	<i>monostigma</i>	79
	<i>quinquelineatus</i>	79
	<i>vitta</i>	81
	<i>luzonia</i> , <i>Scopelogadus</i>	85
	<i>luzonius</i> , <i>Lutianus</i>	79
	<i>macracanthus</i> , <i>Platycephalus</i>	103
	<i>macrolepidotus</i> , <i>Novaculichthys</i>	94
	<i>macrolepis</i> , <i>Myripristis</i>	60
	<i>Sillago</i>	87
	<i>macropteroides</i> , <i>Archamia</i>	74
	<i>macrosomus</i> , <i>Decapterus</i>	63
	<i>macurus</i> , <i>Monacanthus</i>	100
	<i>maculatus</i> , <i>Epinephelus</i>	76
	<i>Pomadasis</i>	83
	<i>Mænidæ</i>	71
	<i>mahsenoides</i> , <i>Lethrinus</i>	87
	<i>malabaricus</i> , <i>Lutianus</i>	81
	<i>margaritifera</i> , <i>Scopelogadus</i>	84
	<i>margaritophora</i> , <i>Amia</i>	74
	<i>marginatus</i> , <i>Hemiramphus</i>	58
	<i>mauritiana</i> , <i>Anguilla</i>	56
	<i>Megalaspis cordyla</i>	65
	<i>Megalops cyprinoides</i>	53
	<i>melanotænia</i> , <i>Labracinus</i>	95
	<i>mentalis</i> , <i>Apogonichthys</i>	74
	<i>merra</i> , <i>Epinephelus</i>	75
	<i>mesothorax</i> , <i>Lepidaplois</i>	94
	<i>microlepidotus</i> , <i>Scomber</i>	61
	<i>microphthalmus</i> , <i>Myripristis</i>	60
	<i>miniatus</i> , <i>Halichoeres</i>	94
	<i>minuta</i> , <i>Gazza</i>	69
	<i>moana</i> , <i>Pseudupeneus</i>	88
	<i>moansii</i> , <i>Lethrinus</i>	86
	<i>moluccensis</i> , <i>Harengula</i>	53
	<i>Pomacentrus</i>	89
	<i>Monacanthidæ</i>	100

	Page.		Page.
Monacanthus chinensis	100	Pempheris vanicolensis	75
macrurus	100	Pentapus caninus	84
monochrous, Amia	72	setosus	84
Monodactylus argenteus	71	perforata, Sardinella	54
monogrammus, Scelopopsis	85	petimba, Fistularia	56
monostigma, Lutianus	79	Petrosiartes grammistes	104
Mugil planiceps	59	Pharopteryx nigricans	78
sundaniensis	59	phekadopleura, Stethojulis	93
Mugilidae	59	philippinus, Pomacentrus	91
Mullidae	87	Zenarchopterus	59
Mulloides japonicus	88	pictus, Plectorhynchus	84
samoensis	87	piersoni, Nesogrammus	61
vanicolensis	87	Pinjalo typus	81
Muraenidae	56	Plectropoma calcariferum	78
murdjan, Myripristis	60	planiceps, Mugil	59
Myetophidae	55	Platacidae	97
Myctophum gilberti	55	Platophrys javanicus	105
myops, Trachinocephalus	55	neglectus	105
Myripristis macrolepis	60	palad	105
microphthalmus	60	pantherinus	105
murdjan	60	russellii	105
pralinius	60	Platycephalidae	103
naucrates, Echeis	104	Platycephalus bataviensis	103
neglectus, Platophrys	105	insidiator	103
nematacanthus, Lethrinus	86	macracanthus	103
Nemipterus japonicus	82	Platax orbicularis	97
nemurus	81	Plectorhynchus celebicus	84
ovenii	82	chrysotania	84
taeniopterus	82	goldmanni	84
worcesteri	81	pictus	84
nemurus, Nemipterus	81	Plotosidae	56
Nesogrammus	61	Plotosus anguillaris	56
piersoni	61	pocilus, Halichoeres	95
Netma thalassinus	56	Pomacentridae	89
niger, Balistes	99	Pomacentrus alexanderae	90
nigrescens, Halichoeres	94	jerdoni	89
nigricans, Pharopteryx	78	littoralis	89
nigrofasciata, Seriola	63	moluccensis	89
nigropunctatus, Tetraodon	101	philippinus	91
Nototheniidae	103	popei	90
Novaculichthys macrolepidotus	94	taenurus	89
novae-guinae, Amia	72	trimaculatus	89
obtusata, Sphyræna	60	tripunctatus	89
obtusauris, Cephalopholis	77	Pomadasis maculatus	83
octofasciatus, Chaetodon	96	popei, Pomacentrus	90
oktodon, Callyodon	96	pralinius, Myripristis	60
Ophicephalidae	103	Priacanthidae	78
Ophicephalus striatus	103	Priacanthus hamrur	78
ophthalmotania, Caranx	64	Psammoperca waigiensis	78
orbicularis, Platax	97	Psettodes erumei	106
ornatus, Lethrinus	87	Pseudochromidae	95
Osbeckia scripta	100	Pseudupeneus barberinus	88
Ostraciidae	101	bifasciatus	88
Ostracion gibbosum	101	indicus	88
tuberculatum	101	luteus	89
Otolithus argenteus	87	moana	88
ovenii, Nemipterus	82	spilurus	88
Oxyurichthys cristatus	104	Pterois volitans	103
pachycentron, Cephalopholis	76	punctatum, Xystema	69
palad, Platophrys	105	purpurescens, Halichoeres	94
pantherinus, Platophrys	105	puta, Terapon	88
paradiseus, Labroides	94	quadrifasciata, Amia	71
Parapercis hexophthalma	103	quadrilineatus, Terapon	83
Pardachirus pavoninus	107	quinquelineatus, Lutianus	79
pavoninus, Pardachirus	107	quoyi, Callyodon	96
pelamis, Gymnosarda	61	Hyporhamphus	58
Pempheridae	75	Rachycentron canadus	61

	Page.		Page.
reevesii, Calliurichthys.....	103	Sphyrnidae.....	59
richardsoni, Gymnothorax.....	56	splendens, Leiognathus.....	67
Lethrinus.....	86	stereocarius, Leiognathus.....	67
russelli, Umbrina.....	87	Stethojulis pleuropleura.....	93
russelli, Platophrys.....	105	zatima.....	93
Salarias fasciatus.....	104	Stolephorus delicatulus.....	53
samoensis, Mulloides.....	87	gracilis.....	53
sangiensis, Amia.....	72	striatus, Ctenochaetus.....	97
Sardinella clupecoides.....	54	Ophicephalus.....	103
perforata.....	54	strigata, Valencienna.....	104
Saurida argyrophanes.....	54	strigatus, Aeoliscus.....	57
gracilis.....	54	sulphurus, Upeneus.....	88
saurus, Elops.....	53	sundaicus, Upeneus.....	88
savayensis, Amia.....	72	sundanensis, Mugil.....	59
scabra, Sebastopsis.....	102	Synaptura sorsogonensis.....	106
scapularis, Halliceres.....	94	Syngnathidae.....	57
Scarichthyidae.....	95	Synodontidae.....	54
Scarichthys caeruleopunctatus.....	95	Synodus varius.....	55
Sciaenidae.....	87	tæniopterus, Nemipterus.....	82
Scolopsis bilineatum.....	84	tæniurus, Pomacentrus.....	89
bulanensis.....	85	tapeinosoma, Gazza.....	69
cancellatum.....	84	Taurichthys varius.....	97
luzonia.....	85	tauvina, Epinephelus.....	75
margaritifera.....	84	temminckii, Atherina.....	59
monogrammus.....	85	Terapon jarbua.....	83
Scomber brachysomus.....	61	puta.....	83
japonicus.....	61	quadrilineatus.....	83
microlepidotus.....	61	theraps.....	83
Scomberoides tolo-parab.....	62	Tetraodon nigropunctatus.....	101
Scombridae.....	61	Tetraodontidae.....	100
Scorpenidae.....	101	thalassinus, Neotoma.....	56
Scorpididae.....	71	Thalassoma lunaris.....	94
scripta, Osbeckia.....	100	theraps, Terapon.....	83
sebae, DiaCOPE.....	78	thrissa, Konosirus.....	54
Sebastopistes tristis.....	102	toloo-parab, Scomberoides.....	62
Sebastopsis scabra.....	102	Trachinocephalus myops.....	55
selene, Chætodon.....	96	Trachinotus baillonii.....	66
septemfasciatus, Abudedefduf.....	93	tragula, Upeneus.....	88
Serranidae.....	75	Trichiuridae.....	62
serrata, Fistularia.....	5	Trichiurus haumela.....	62
Seriola nigrofasciata.....	63	trimaculatus, Pomacentrus.....	89
setosus, Pentapus.....	84	tripunctatus, Pomacentrus.....	89
sexfasciatus, Caranx.....	65	trispilos, Labracinus.....	95
sexlineatus, Grammistes.....	78	tristis, Sebastopistes.....	102
Siganidae.....	98	turberculatum, Ostracion.....	101
Siganus fuscescens.....	98	Tylosurus giganteus.....	58
javus.....	98	leiuroides.....	58
lineatus.....	98	typus, Pinjalo.....	81
vermiculatus.....	98	Umbrina dussumieri.....	87
virgatus.....	98	russelli.....	87
Sillaginidae.....	87	undulatus, Balistapus.....	100
Sillago macrolepis.....	87	unicornis, Acanthurus.....	98
Siluridae.....	56	unimaculatus, Abudedefduf.....	93
simus, Cypsilurus.....	58	Chætodon.....	97
Soleichthys heterorhinos.....	107	Lo.....	98
Soleidae.....	106	Upeneus sulphurus.....	88
sorsogonensis, Synaptura.....	106	sundaicus.....	88
Sparidae.....	86	tragula.....	88
Sparus calamara.....	86	urotænia, Ambassis.....	75
speciosus, Caranx.....	64	vagabundus, Chætodon.....	96
spilurus, Pseudupeneus.....	88	Valencienna strigata.....	104
Spheroides lunaris.....	101	vanicolensis, Mulloides.....	87
Sphyræna jello.....	59	Pempheris.....	75
langsar.....	60	variegatus, Lethrinus.....	86
obtusata.....	60	varius, Taurichthys.....	97

	Page.		Page.
<i>varius</i> , <i>Synodus</i>	55	<i>Xystæma baconensis</i>	69
<i>vermiculatus</i> , <i>Siganus</i>	98	<i>kapas</i>	70
<i>virgatus</i> , <i>Leiognathus</i>	67	<i>punctatum</i>	69
<i>Siganus</i>	98	<i>zatima</i> , <i>Stethojulis</i>	93
<i>vitta</i> , <i>Lutianus</i>	81	<i>zebra</i> , <i>Dendrochirus</i>	103
<i>volitans</i> , <i>Pterois</i>	103	<i>Zenarchopterus dispar</i>	59
<i>waigiensis</i> , <i>Psammoperca</i>	78	<i>philippinus</i>	59
<i>worcesteri</i> , <i>Nemipterus</i>	81	<i>zonatus</i> , <i>Abudefduf</i>	92
<i>xanthurus</i> , <i>Abudefduf</i>	92		

