

505.914²⁷

THE PHILIPPINE JOURNAL OF SCIENCE

ALVIN J. COX, M. A., PH. D.
GENERAL EDITOR

SECTION B TROPICAL MEDICINE

EDITED WITH THE COÖPERATION OF
E. L. WALKER, S. D.; M. A. BARBER, PH. D.; A. R. WARD, D. V. M.
Committee on Experimental Medicine
V. G. HEISER, M. D.; W. E. MUSGRAVE, M. D.; B. C. CROWELL, M. D.
Committee on Clinical Medicine
R. C. MCGREGOR, A. B.

VOLUME IX
1914

WITH 15 PLATES, 24 TEXT FIGURES, 1 MAP, AND 7 CHARTS



MANILA
BUREAU OF PRINTING
1914

129662

233254 ✓

CONTENTS

No. 1, February, 1914

Page.

BARBER, M. A. Cockroaches and ants as carriers of the vibrios of Asiatic cholera	1
HEISER, VICTOR G. Reappearance of plague in the Philippines after an absence of six years. Brief description of the outbreak, the methods used to combat it, and the probable factors in its introduction	5
One map.	
BOYNTON, WILLIAM HUTCHINS. A preliminary report of experiments on the cultivation of the virus of rinderpest in vitro.....	39
BOYNTON, WILLIAM HUTCHINS. An atypical case of rinderpest in a carabao	45
One chart.	
WARD, ARCHIBALD R., WOOD, FREDERICK WILLAN, and BOYNTON, WILLIAM HUTCHINS. Experiments upon the transmission of rinderpest	49
Two plates and 6 charts.	
WILLETS, DAVID G. Intestinal parasitism, particularly entamœbiasis, in patients of the Philippine General Hospital, Manila, P. I.....	81
WILLETS, DAVID G., with the coöperation of STANLEY, COURT R., and GUTIERREZ, PERPETUO. Preliminary report on the treatment of entamœbiasis with ipecac, emetine, and neosalvarsan at the Philippine General Hospital, Manila, P. I.....	93
GIBSON, R. B., and CONCEPCIÓN, ISABELO. Nerve degeneration in fowls fed on unhusked rice (palay).....	119
One plate.	
WARD, ARCHIBALD R., and WOOD, FREDERICK WILLAN. Simultaneous method of inoculating cattle and carabaos with serum from animals that have been recently immunized.....	125
Three plates.	

No. 2, April, 1914

A JOINT COMMISSION OF REPRESENTATIVES FROM THE COLLEGE OF MEDICINE AND SURGERY, UNIVERSITY OF THE PHILIPPINES; BUREAU OF SCIENCE; AND BUREAU OF HEALTH. Sanitary survey of the San Jose Estate and adjacent properties on Mindoro Island, Philippine Islands, with special reference to the epidemiology of malaria	137
One plate and 2 text figures.	

No. 3, June, 1914

CALDERON, FERNANDO. Some data concerning the medical geography of the Philippines.....	199
--	-----

	Page.
SCHÖBL, OTTO. The etiology of trichomycosis palmellina in the Philippine Islands One plate.	219
JOHNSTON, JOHN A. A contribution to the bacteriology of leprosy. Preliminary note One plate.	227
WILLETS, DAVID G. Intestinal helminthiasis in the Philippine Islands as indicated by examinations of prisoners upon admission to Bilibid Prison, Manila, P. I.....	233
MUSGRAVE, W. E., and SISON, A. G. Bacillary dysentery: The most prevalent form in Manila and its treatment.....	241
WILLETS, DAVID G. Widal reactions among healthy adult Filipinos....	253
BOYNTON, WILLIAM HUTCHINS. Experiments on the cultivation of rinderpest virus as described by Baldrey.....	259
BOYNTON, WILLIAM HUTCHINS. Kidney-worm infestation of swine in the Philippine Islands with special reference to the pathological changes Three plates.	269
LIGHT, S. F. Another dangerous jellyfish in Philippine waters.....	291
GIBSON, R. B. Some simple laboratory apparatus..... Three text figures.	297
Reviews	303
No. 4, August, 1914	
BARBER, MARSHALL A. The pipette method in the isolation of single microorganisms and in the inoculation of substances into living cells. With a technique for dissection, staining, and other processes carried out under the higher powers of the microscope.... Two plates and 19 text figures.	307
CROWELL, B. C. Notes on the diagnosis of Asiatic cholera at autopsy..	361
GUTIERREZ, PERPETUO. Typhoid fever in the Philippines.....	367
Reviews	379
No. 5, September, 1914	
WALKER, ERNEST LINWOOD and BARBER, MARSHALL A. Malaria in the Philippine Islands. I. Experiments on the transmission of malaria with <i>Anopheles</i> (<i>Myzomyia</i>) <i>febrifer</i> sp. nov., <i>Anopheles</i> (<i>Pseudomyzomyia</i>) <i>rossii</i> , <i>Anopheles</i> (<i>Myzorhynchus</i>) <i>barbirostris</i> , <i>Anopheles</i> (<i>Myzorhynchus</i>) <i>sinensis</i> , and <i>Anopheles</i> (<i>Nysorhynchus</i>) <i>maculatus</i>	381
WILLETS, DAVID G. Malaria in the Philippine General Hospital, Manila, P. I., during the fiscal year 1913.....	441
CROWELL, B. C. The chief intestinal lesions encountered in one thousand consecutive autopsies in Manila.....	453
Reviews	461

Contents

v

No. 6, November, 1914

	Page.
RUEDIGER, E. H. The germicidal power of glycerin on various micro-organisms under various conditions.....	465
SCHÖBL, OTTO. The vitality of the cholera vibrio in Manila waters....	479
WALKER, ERNEST LINWOOD. The morphology of the adults of the filaria found in the Philippine Islands..... One plate.	483
ACOSTA-SISON, HONORIA. Pelvimetry and cephalometry among Filipinas	493
GIBSON, R. B. A note on the physiological action of the proteoses....	499
GIBSON, R. B., and CONCEPCIÓN, ISABELO. The lymphagocic action of the Philippine mango, <i>Mangifera indica</i> Linnæus.....	503
CONCEPCIÓN, ISABELO. Observations on mango rash.....	509
BARBER, M. A. Milk poisoning due to a type of <i>Staphylococcus albus</i> occurring in the udder of a healthy cow.....	515
Reviews	521
Index	523

VOL. IX, SEC. B, No. 1

FEBRUARY, 1914

THE PHILIPPINE JOURNAL OF SCIENCE

ALVIN J. COX, M. A., PH. D.
GENERAL EDITOR

SECTION B TROPICAL MEDICINE

EDITED WITH THE COÖPERATION OF

E. L. WALKER, S. D.; M. A. BARBER, PH. D.; A. R. WARD, D. V. M.
Committee on Experimental Medicine

V. G. HEISER, M. D.; W. E. MUSGRAVE, M. D.; B. C. CROWELL, M. D.
Committee on Clinical Medicine

R. C. MCGREGOR, A. B.



MANILA
BUREAU OF PRINTING
1914

**PUBLICATIONS FOR SALE BY THE BUREAU OF SCIENCE,
MANILA, PHILIPPINE ISLANDS**

ETHNOLOGY

A VOCABULARY OF THE IGOROT LANGUAGE AS SPOKEN BY THE MONTOC IGOROTS

By WALTER CLAYTON CLAPP

Order No. 104. Paper, 32 pages, \$0.75, clothbound.

The vocabulary is given in both English and English-Igorot.

THE Dialect OF DALAT

By JOHN CLAPP

THE Dialect OF PALAWAN

By GEORGE Y. HULL

Order No. 105. Paper, 30.00; cloth bound, \$0.75.

The General Dialect of Palawan, 23 (1888) and the Dialect of Palawan (7 (1888) & 1889) are bound under one cover.

THE BAHAN DIALECT AS A MEMBER OF THE PHILIPPINE GROUP OF LANGUAGES

By JOHN CLAPP

THE ANDUT OF THE PHILIPPINE LANGUAGES

By CAROL FOREST CLAPP

Order No. 107.

Order two copies of volume under one cover, 1.00; paper bound, \$0.75, clothbound.

THE STRAITS OF MAMALIGAN MAY

By GEORGE Y. HULL

Order No. 110. Paper, 102 pages, 1 (1888), 23 (1888), 25 (1888), clothbound.

Although May is situated on the northwest coast of Cebu, the Philippine Islands, the Settlement of the name was made by Mr. D. J. Forester, the first settler of the island in 1848.

The 23 names illustrate the influence of the Spanish language in the Philippines, and the names of the islands.

THE HISTORY OF SULU

By NATHAN M. SALSBY

Order No. 43. Paper, 318 pages, 4 (1888), 2 (1888), \$0.75, clothbound.

In the year 1841 of the calendar for the history of Sulu, Sulu was under the control of the Sultan of Sulu. The Sultan of Sulu was the Sultan of Sulu. The Sultan of Sulu was the Sultan of Sulu.

ETHNOLOGY—Continued

STUDIES IN MORO HISTORY, LAW, AND RELIGION

By NATHAN M. SALSBY

Order No. 85. Paper, 107 pages, 16 (1888), 2 (1888), \$0.75, clothbound.

This volume deals with the Arabic written records of the Moros in Mindanao. The names of the sultans of Mindanao are recorded in five foreign districts.

PHENOMENA OF SAVANNAH

By THOMAS ALLEN BIRD

Order No. 112. Paper, 32 pages, 82 (1888), 2 (1888), half clothbound, \$0.75, clothbound.

This is the first scientific study of savanna in the Philippines. It is a study of the savanna in the Philippines. It is a study of the savanna in the Philippines.

IN MANILA

PHILIPPINE ISLANDS

By C. T. HARRIS

Order No. 113. Paper, 16 (1888), 8 (1888), 0 (1888).

This is a study of the Philippines. It is a study of the Philippines. It is a study of the Philippines.

THE CUBAN INDUSTRY IN THE ISLAND OF PALAWAN

By GEORGE Y. HULL

Order No. 114. Paper, 144 pages, 10 (1888), 2 (1888), \$1.25, clothbound.

Commerce from the island of Palawan is the main source of the industry in the island of Palawan. It is the main source of the industry in the island of Palawan.

A MANUAL OF PHILIPPINE MILK CULTURE

By CHARLES S. BARNES

Order No. 115. Paper, 32 pages, 80 (1888), 2 (1888), \$0.75.

This is a manual of Philippine Milk Culture. It is a manual of Philippine Milk Culture. It is a manual of Philippine Milk Culture.

THE PHILIPPINE
JOURNAL OF SCIENCE

B. TROPICAL MEDICINE

VOL. IX

FEBRUARY, 1914

No. 1

COCKROACHES AND ANTS AS CARRIERS OF THE VIBRIOS
OF ASIATIC CHOLERA¹

By M. A. BARBER

(From the Biological Laboratory, Bureau of Science, Manila, P. I.)

Cockroaches, especially of the species *Periplaneta americana* Linn., are very common in dwelling houses in Manila at all seasons of the year. They are voracious feeders on all kinds of organic matter, and at night time, especially, creep over any unprotected human food and discharge their fæces there. Since they have ready access to human fæces in closets not provided with sanitary plumbing, they may become the carriers of infective material from the closets to human food. This is the more probable, since these insects not only creep rapidly, but also fly from place to place. In the following experiments, it was purposed to test the fæces of cockroaches which had previously ingested cholera cultures and human fæces containing cholera vibrios, with the purpose of determining if these insects may not become carriers of Asiatic cholera.

The cockroaches used in these experiments were all *Periplaneta americana* and all winged adults. The method of experimentation was simple. The insects were caught and kept in a jar for a day or more until they had become hungry. They were then distributed in wide-mouthed bottles, one insect to a bottle. Cultures of cholera or liquid human fæces were introduced into the bottles by means of a pipette. Some powdered carmine was added to the fæces or cultures so as to make it possible to identify a fæces sample with a given feeding. Liquid fæces obtained

¹ Received for publication December 8, 1913.

from cholera patients were used with no addition to make them more palatable to the insects.

The cockroaches devoured these fæces greedily; sometimes, a single insect ingested 0.2 cubic centimeter. The insects were transferred to new dry bottles after feeding and kept under close observation in order to obtain fæces fresh for testing. About six hours after their meal, the insects usually began discharging liquid or semiliquid fæces, deeply tinted with carmine. On the day following the feeding and on subsequent days, the insects were given beef broth containing maltose, but no more cholera vibrios or carmine. The maltose broth was fed to them in order to obtain fresh fæces for testing. A discharge of fæces usually followed this meal—often immediately. Carmine sometimes persisted in the fæces for six days after feeding.

Tests were made by immediate microscopical observation, by direct transfer to Dieudonné plates, and by transfer to peptone for subsequent test on Dieudonné plates. All vibrios were tested by a specific agglutinating serum.

In 8 cockroaches fed with human fæces, cholera vibrios were recovered from the insects' fæces six hours or more after feeding. In one case they were found in comparatively small numbers seventy-nine hours after feeding, and in several other cases they occurred in greater or less numbers from twenty-four to forty-eight hours after the ingestion of fæces. In one case they were obtained twenty-four hours after feeding with a cholera culture.

Actively motile cholera vibrios often appeared in enormous numbers in the insects' fæces. In two cases, thirty-two hours after feeding, they were so plentiful that the material was immediately suitable for an agglutination test in hanging drop. They were apparently as numerous as in the original human fæces. In another insect, Dieudonné plates made directly from fæces discharged two days after feeding showed thousands of colonies. They were also seen in great numbers in fæces at less intervals after the feeding. Generally, they seemed to diminish in number after twenty-four hours. In two cases, fæces obtained twenty-nine and one-half and thirty and three-fourth hours, respectively, after feeding gave negative results, although carmine still persisted in the fæces and these same insects had passed fæces containing cholera vibrios five hours previously. On the following day, the fæces of both these insects were free from carmine and gave negative cholera tests. The cockroaches were kept at a room temperature of from 29° to 31° C.

The longevity of cholera vibrios in cockroach fæces after discharge from the insect is probably short when the fæces are

deposited in places where they can readily dry, but when discharged on moist food vibrios may remain for some time. To test this matter, some fresh cockroach fæces were placed on four different kinds of food: fresh beef, lettuce, fish, and clams. In every case, the cholera vibrios remained viable for at least sixteen hours at room temperature.

In this connection it may be worth while to mention the results obtained by me in some recent experiments on the longevity of cholera vibrios in human fæces placed on various foods in use in this locality. Here, as in the case of the experiments with cockroach fæces, the cholera vibrios must compete with the other bacteria present in the fæces and with the microorganisms already present in the food. On the cut surfaces of a cucumber, a chico, and a papaya fruit—all distinctly acid to litmus—and on the leaves of lettuce, the cholera vibrios survived overnight in one experiment. In another test, cholera vibrios in human fæces survived twenty hours on the cut surfaces of cucumber and papaya fruits, but failed to live forty-four hours. On two varieties of shrimp, cholera vibrios in human fæces remained viable twenty-two hours; on oysters, forty-six hours; and on the inside of an opened clam, four days. In all of these four foods, other bacteria were very numerous; in the oysters, especially, they were so plentiful that the food was acid in reaction when the cholera vibrios were placed on it. It is probably fair to assume that cholera vibrios, when abundant in cockroach fæces, would survive as long on foods as when in human fæces.

In addition to their fæces, the vomit of these insects may also be a source of danger. A fæces-fed cockroach was observed to disgorge portions of its meal at intervals of ten minutes, twenty minutes, and sixty minutes after feeding—sufficient time to allow the insects to travel from a closet to human food. The sixty-minute sample contained many cholera vibrios. These insects often discharge a thin saliva from the mouth. This fluid seems to be nearly, if not quite, bacteria-free, and tests failed to show any cholera vibrios in it. The vomit mentioned above is of a different nature, as shown by the carmine tint and by bacteria and other substances seen in microscopical examination.

As might be expected, cockroaches show no evidence of infection by cholera. The vibrios are simply held in the intestine, and apparently become no more numerous than in the ingested human fæces. In order to determine if there is any loss of virulence in cultures of cholera vibrios isolated from cockroach fæces, a comparative test was made by guinea-pig inoculations.

A culture was isolated from a sample of human fæces, and this sample was then fed to a cockroach. Twenty-nine hours afterward, a second culture was isolated from the fæces of the cockroach. Young agar cultures of the two cultures were tested by intraperitoneal inoculation into 200-gram guinea pigs. In the culture isolated from the cockroach, one-eighth of a loop was fatal after about twenty-seven hours and one-sixteenth of a loop failed to infect. In the culture isolated directly from the human fæces, one-fourth of a loop was fatal in less than twenty-four hours and one-eighth of a loop nonfatal. So there is no evidence of loss of virulence in cholera vibrios after twenty-nine hours in the intestine of the cockroach.

Ordinary red ants (probably *Monomorium latinode* Mayr) are also possible cholera carriers, since they are omnivorous feeders and will penetrate to any food not carefully protected from them. Some experiments were conducted on these insects, but owing to the small volume of their fæces it was difficult to make a test before the fæces became dry. The ants ate cholera cultures and human fæces containing cholera vibrios readily, and in one group of culture-fed ants cholera vibrios were recovered from the crushed bodies of the insects about eight hours after feeding. It is very probable that their fæces also contained living vibrios, since carmine-tinted liquid fæces were discharged, but these became dry before they could be tested. In a second group of ants fed with human fæces, cholera vibrios were recovered from the crushed bodies nearly nine hours after feeding.

In summary, cockroaches which have fed on human cholera fæces may harbor cholera vibrios in their intestines, and these may appear in enormous numbers in the insects' fæces for at least two days after the insects have fed, and may occur in smaller numbers seventy-nine hours after ingestion. By means of both fæces and vomit, cockroaches may act as carriers of cholera to human food. Cholera vibrios in cockroach fæces will survive on human food at least sixteen hours after discharge from the insect, and cholera vibrios in human fæces will survive, in competition with numerous other bacteria, on food at least four days. There is no loss of virulence for guinea pigs in cholera vibrios after twenty-nine hours in the intestine of the cockroach. Cholera vibrios may be found in the bodies of ants at least eight hours after they have ingested cholera cultures or human fæces from cholera patients.

REAPPEARANCE OF PLAGUE IN THE PHILIPPINES AFTER AN ABSENCE OF SIX YEARS ¹

BRIEF DESCRIPTION OF THE OUTBREAK, THE METHODS USED TO COMBAT IT,
AND THE PROBABLE FACTORS IN ITS INTRODUCTION

By VICTOR G. HEISER

(Director of Health for the Philippine Islands)

One map

The Far Eastern Association of Tropical Medicine has been a beneficent influence in disseminating useful sanitary information among medical men of the Orient, and has been a great factor in promoting friendly relationship between the countries from which its membership is drawn.

In choosing plague as a subject, we deal with a disease that concerns all of us, because it is constantly present in some ports of the Orient and is one that constantly threatens our frontiers. The factors concerned in the transmission of the disease are now so generally accepted that a study of the methods of combating plague in the different countries shows them to be very much the same.

Therefore, the purpose of this paper will be, in addition to a brief description of the outbreak in the Philippine Islands, to refer particularly to those features which have not been so frequently mentioned in the literature of the disease.

After an absence of six years in human beings and five years in rats, plague was again found in the Philippine Islands in man on June 17, 1912. From the beginning of the outbreak up to the present time, there have been in Manila 68 cases with 58 deaths, which gives a mortality of 85.3 per cent. At Iloilo, there were 9 cases with 9 deaths. In view of the fact that Manila is a city with a population of approximately 300,000 and is largely built up with a poor type of wooden buildings, which furnish ideal harboring places for rats, it would not have been strange if there had been more cases. In fact, a much larger number of cases could have been reasonably expected. On account of the almost daily communication which Manila has with plague-infected foreign ports which are within a few days' steaming distance for the average vessel and since passengers, crew, rodents, and vermin may arrive well within the incubation period of the disease, it is remarkable that the Philippines should have remained free from plague for so many years. This freedom

¹ Read at the third annual meeting of The Far Eastern Association of Tropical Medicine held at Saigon, November, 1913.

can probably be attributed to the fact that all such vessels are fumigated at intervals of not greater than six months with sulphur dioxide and that they unload either into lighters in the bay or on to rat-proof wharves.

UNUSUAL CHARACTER OF PLAGUE AT QUARANTINE

It is perhaps worthy of note that, prior to the appearance of plague in Manila a number of cases of the disease was found on incoming steamers. For instance, on April 6, 1912, a death was reported on the steamship *Zafiro*, which had arrived the day previous from Hongkong and had been in the harbor for twenty-four hours at the time of the death. At the medical inspection of the vessel, which was made the day previous, no illness was detected. An investigation showed that the victim had been on deck on the night of April 5, 1912, in apparently good health. The next morning, at 6 o'clock, he was found dead in his bunk. The necropsy and subsequent biological findings reported by Dr. R. P. Strong of the Bureau of Science showed that death was due to pneumonic plague.

On April 7, 1912, the steamer *Loongsang* arrived in Manila from Hongkong, and the captain reported that a death had occurred the day previous in a Chinese member of the crew. Upon investigation of this case, the captain stated that the man was apparently in good health, but that while hauling on a rope he fell over in an apparent faint and was placed in a chair and in the course of a few hours expired. The necropsy and animal inoculations showed that he had died of plague and probably of the pneumonic variety.

Beginning April 7, 1912, the temperature of all members of the crew and of the passengers that arrived in vessels from foreign ports was taken with a view to detecting any possible cases of plague.

On the arrival of the steamship *Taisang* from Amoy at the Mariveles Quarantine Station at about 6.30 a. m. on April 30, 1912, the entire personnel was carefully examined and found free from sickness of a suspicious nature and from elevations of temperature. Seventy-three persons were detained to serve a quarantine detention of seven days. On the evening of April 30, a Chinese passenger, aged 51 years, was found to have a temperature of 39° C. with a pulse of 100. He was placed in the hospital, but protested vehemently that he was not sick. He was carefully watched from the first; there was a slight cough; physical examination of the chest revealed a few râles; smears made of the sputum and stained for plague bacilli were negative.

On the fifth day, the fever still persisted, but the patient stated that he did not feel ill and demanded to be released from the hospital. On this day, the expectoration was bloodstained, but no suspicious organisms could be found in the smears nor could any physical signs of pneumonia be detected. Furthermore, there were no palpable glands. On the morning of the seventh day, the temperature and pulse dropped and the general condition was distinctly worse. The patient now admitted that he felt ill. Several hours later, he flinched when pressure was made in the right axilla. Lymphatic enlargement was now made out, and by the evening of the seventh day the bubo in the axilla had increased markedly in size, the swelling approximating 3 by 7 centimeters. Glands now became palpable in other portions of the body, particularly in the cervical region, and a few hours later there were inguinal and femoral buboes. The patient became rapidly worse, and died at 7 o'clock on the morning of the eighth day of his illness. At the necropsy, the glands of the right axilla and those of the right side of the neck were found enlarged; the other lymphatic glands were also enlarged, but to a lesser degree. There was consolidation of the lower lobe of the right lung, and the spleen was about twice its normal size. In brief, the necropsy findings of a typical case of septicæmic plague were present. Smears from the spleen and the right axillary gland showed immense numbers of bipolar-staining organisms. Cultures made from fresh pieces of tissues and later inoculated into animals gave positive results for plague.

ROUTINE RAT PRECAUTIONS PRIOR TO HUMAN OUTBREAK

The city of Manila is divided into 5 sanitary divisions. Each division is in charge of a medical officer, who has a corps of from 10 to 40 sanitary inspectors to assist him. During the entire six years during which plague was absent, test rat catching was done at weekly intervals under the direction of each station at places that were believed to be liable to become rat-plague infected, and in addition any unexplained mortality among rats was always investigated, but at no time were plague rats found.

HUMAN CASES

In view of the foregoing, it was with considerable surprise that the first case of plague was found in a human being. This case was discovered June 17, 1912, in a Filipino employed as a watchman at 236 Calle San Jacinto, which is in the Chinese district, his residence being at 920 Calle Antonio Rivera, which is the slum section of the city.

The victim was found dead at his home with a history of having been ill for about three days. On post-mortem examination, typical plague buboes were found in the right groin and axilla. Inoculation into guinea pigs resulted in typical attacks of plague. The victim was a permanent resident of Manila, and had not been away from the city in many months. He worked and lived in a section that is far removed from the water front, and did not associate with persons who had been out of the city or persons who were connected with shipping. So far as known, the nearest focus of the disease was Hongkong. Therefore, the source of this infection was difficult to explain.

The next case was found June 26 in a Filipina woman who lived at 1615 Calle Azcarraga near the Arranque market, which is over a kilometer from the place where the previous victim either worked or lived.

The next case did not occur until August 4, which was thirty-nine days later. This victim resided at 139 Calle Villalobos in Quiapo, which is a large retail district located near the Pasig River and fully 1.5 kilometers from where the previous case had occurred.

The next case occurred on August 7 on the same street and block as the preceding case.

The next case occurred on August 21 at 352 Calle Echague, a street corner, which is also in the same block as Calle Villalobos.

It may be of interest to note that these last three cases were all in schoolboys under 16 years of age.

By October 20, there had been 13 cases from the beginning of the outbreak, and these occurred at irregular intervals and in different sections of the city. Then between the dates of October 20 and October 22, 13 new cases occurred, so that in a period of two days there were as many cases as there had been during the four preceding months.

EXPLOSIVE HUMAN OUTBREAK

An investigation showed that in these latter 13 cases there was definite geographic grouping, which was a feature that had not occurred up to that time. The victims were all laborers who worked at the freight station of the Manila Railroad Company. Inquiry developed the fact that large numbers of rats had been seen dying first in the north warehouse and a few weeks later in the south warehouse. About three weeks after the heavy rat mortality was noticed in the north warehouse, plague appeared among the laborers in the south warehouse. The ware-

houses (godowns) were galvanized iron buildings with a dirt floor, on sections of which a board floor had been constructed. Numerous rat runs were found that led under the boards, and upon these floors being removed rat nests and a number of dead rats were found. The rats were mummified, rendering it impracticable definitely to ascertain the cause of their death. It is customary in the Philippines for laborers to go barefooted and barelegged as far as the knee, and as these employees were no exception there was ample opportunity for fleas to bite them on their lower extremities.

From October 22 until October 31 there were 8 additional cases traceable to the warehouse, and then the outbreak stopped as suddenly as it began. The preliminary sanitary measures were completed by October 25, and as there were no further cases after the incubation period had expired it seems fair to assume that the sanitary measures were completely effective.

The control of this explosive outbreak probably furnished as good an example of the effectiveness of modern sanitary measures against plague as can be found in the literature of the disease. As there were several hundred laborers employed in these freight warehouses, there is every reason to believe that large numbers of additional cases would have occurred if the proper steps had not been promptly taken to eliminate the infection.

PLAGUE AMONG RATS

Upon the discovery of the first case of human plague on June 17, a careful investigation was again made, but no history of any unusual mortality among rats could be elicited. Immediate steps were taken to catch rats in the sections of the city in which the victim had worked and where he had lived. This work was very actively carried out, but it was not until August 31 and until over 7,000 rats had been caught that a plague rat was detected. This rat was caught in a spring trap at 351 Calle San Sebastian, which is in the block in which the human case on Calle Villalobos had occurred during the first week in August. On September 7, a plague rat was found at 104 Calle Santa Rosa and another at 215 Calle Echague, both of which addresses are within a block of the case that occurred on Calle Villalobos. On October 4, a plague rat was found at 644 Calle Ilaya and another at 637 Avenida Rizal, which are sections far removed from where either human or rat plague had occurred heretofore. During the early part of October, the rat-catching efforts were increased and rats were caught at the rate of approximately

9,000 per month, but the percentage of infected rats found up to November was only 0.005, which is unusually low. According to many authorities, a 2 per cent rat-plague infection is considered a low average. At Hongkong, for instance, it has been reported that 7 per cent of the rats examined prove to be plague infected.

PLAGUE AMONG OTHER ANIMALS

On November 26, 1912, five dead rats were reported from the United States Army Commissary warehouse, which is located on the Pasig River near Malecon Drive and is on the south side of the Pasig River. All infections heretofore had occurred on the north side of the river. Unfortunately the rats were thrown into the river and, therefore, the causes of their death could not be ascertained.

On November 27, a cat known to have caught and eaten rats in this Commissary warehouse was reported to be sick and was taken to the Bureau of Science, where it was observed for a period of three days, at the end of which time it died. At the necropsy, typical bubonic cervical plague glands were found, and inoculations made into guinea pigs from material from the spleen and buboes produced typical plague in the guinea pigs. A guinea pig that was inoculated by a swab introduced into the cat's rectum also died from plague.

Eighty rats were caught in this and adjacent warehouses, but none of them showed any evidence of plague.

On December 17, a woman died of plague at 4 Calle Barraca. Two hours later, Doctor Jackson, the medical officer in charge of the antiplague measures in Manila, and Doctor Schöbl, the laboratory representative of the Bureau of Science, placed 2 healthy guinea pigs free from plague in a wire cage upon the *petate* (mat) which was located on the floor and on which the woman slept, and left them there for one day; the routine-insecticidal measures were delayed until after the guinea pigs had been removed. On December 21, one of the guinea pigs died from typical bubonic plague, the diagnosis being fully confirmed by inoculations into other animals. The guinea pigs were carefully searched for fleas, but none could be found. Guinea pigs under similar circumstances were placed in two other houses in which plague had occurred, but after the disinfecting and insecticidal measures had been completed. In neither case did plague result in the guinea pigs, which would indicate again that the sanitary measures employed were effective.

RARENESS OF SICKNESS OR DEATH FROM PLAGUE IN RATS

An interesting incident in connection with the plague outbreak was the rareness with which rats were found that were either sick from plague or dead as a result of plague. Among a total of 37 rats in which plague was detected, a rat sick of plague was found only once, and rats dead of plague were found in but three instances, two of which did not occur until September, 1913. Of the remaining rats that were found to be afflicted with plague, 20 were killed in a spring trap, 8 died as a result of poison, 3 were killed with a club or other weapon, and in 2 the cause of death was not ascertained.

RAT NESTS

The principal measures in eradicating plague were directed toward finding and destroying rat nests. It was thought that in this way the danger of infected fleas spreading the plague among rats could be largely eliminated, and the small number of cases of rat-plague infection which occurred may be explained through this sanitary measure. Experience shows that fleas spend much time in rat nests, and by disturbing the nesting place and by spraying it frequently with an insecticide the number of opportunities for fleas to spread the disease is certainly very much lessened. In order to accomplish this purpose, a gang of laborers composed of about 100 men was divided into three sections, each under the charge of an experienced sanitary inspector. These gangs go from house to house, and make a thorough systematic search for rat-breeding places. After the search of the house is completed, the woodpiles, old junk, rubbish, and everything that is liable to harbor rats outside of the house are moved about so that the nests may be discovered and destroyed. Particular attention is given to spraying with an insecticide so that fleas may not escape. It was found that woodpiles are favorite harboring places for rats, and these are invariably taken down and re-piled well above the ground and away from the wall, so that dogs and cats may work effectively in keeping rats out of them in the future.

In view of the great importance which has been attached by the Javanese sanitary authorities to destroying rats in hollow bamboos, special stress was directed toward finding them in similar breeding places in the Philippines. At first, these efforts did not meet with much success. However, when the plague spread to sections of the city in which bamboo and thatched houses predominate, rats were frequently found breeding in

the hollow bamboos, and our experience in the Philippines therefore fully confirmed the experience of the Javanese authorities.

RELATIONSHIP OF HUMAN TO RAT PLAGUE

In the 68 cases of human plague, rats afflicted with plague were only found on three occasions in the house or premises in which the victim died or worked. The first of these instances has already been mentioned under the head of explosive outbreak at the Azcarraga station of the Manila Railroad Company. The second occurred in a jewelry shop, and will be discussed under the head of multiple house infection. The third was that which resulted in the death of the editor of the Manila Daily Bulletin.

It is also of interest to know that human plague existed for over two months before any rat plague could be found. Notwithstanding the foregoing, an examination of the map in the appendix of this report shows that by districts there was a very close relationship between human and rat plague in Manila, and in none of the human cases, after rat plague had once been discovered, could a history be obtained that the human victim had not been in the district in which plague rats were found. In every instance, he either lived or worked in such a section.

MULTIPLE HOUSE INFECTIONS

The first instance of multiple house infection was that already described under explosive human outbreak, which occurred at the freight warehouse of the Azcarraga railway station. The next was reported on February 18 at 1028 Calle Comercio. A Chinese boy, aged 15, died of plague on the 12th, and a Chinese, aged 50, died of plague on February 18. During the week ending April 27, there were 5 cases of plague, all in Filipinos, that occurred among the employees of a silversmith shop at 1364 Calle Sande. These men were all employed on the first floor, which was of cement. Ordinarily, such construction would be regarded as rat proof; but, owing to the openings which resembled rat holes, found near the sides, and cracks located here and there, it was deemed advisable to tear out the floor. Several mummified rats were found underneath, the death of which was in all probability due to plague, although this fact could not be definitely established. It is assumed that the fleas made their way through the cracks in the floor or perhaps left a plague-sick rat during its migrations through the shop. This was another striking instance of the close relationship which exists between rat and human plague.

On May 15, there was a second death from plague at 1226 Calle Juan Luna, the first cases having occurred on May 14.

A review of the history of the plague outbreak in Manila shows that the disinfecting and insecticidal measures taken at each house must have been effective, because there is not a single instance on record of a second case of plague having occurred in any house after the incubation period of the disease had expired.

SEASONAL PREVALENCE

The following table shows the prevalence of plague by months. The seasonal prevalence of plague in many Oriental ports is of the greatest epidemiological significance. In Hongkong, for instance, the greatest number of cases for many years has generally occurred in May, and the smallest, in December. In Amoy, which is several hundred kilometers farther north, the greatest number of human cases occurs in June. The following table indicates that the greatest number of cases occurs in the Philippines in October, but this can be considered more or less accidental, because the majority of those that occurred in October were due to the explosive outbreak which was traced to the Azcarraga railway station, and that can scarcely be ascribed to seasonal reasons. There is also placed alongside the human cases the incidence of rat plague, which shows that the greatest number of plague rats was found in March. A study of these would seem to show that if the often-quoted observation is true that human cases should follow two months after rat plague has occurred, the greatest number of human cases should have occurred in Manila in May. The sanitary measures which were so actively carried out against rats during March and April may have prevented this.

TABLE I.—*Distribution by months of human and rat plague cases in Manila.*

Month and year.	Human plague cases.	Rat plague cases.	Month and year.	Human plague cases.	Rat plague cases.
1912.			1913.		
June	2	0	February	3	1
July	0	0	March	4	13
August	5	1	April	6	3
September	3	2	May	3	7
October	21	1	June	0	3
November	12	1	July	0	0
December	6	3	August	1	0
1913.			September	1	3
January	1	0	October	0	0

EVIDENCE OF FLEA TRANSMISSION OF PLAGUE

On account of the completeness of the results obtained by the investigation of the death from plague of William Crozier, the editor of the Manila Daily Bulletin, it is thought that it might be of interest to give a brief description of the findings. Mr. Crozier felt ill on the evening of September 18, 1913. On the morning of the 19th, he was admitted to a local general hospital. By afternoon he developed symptoms suspicious of plague, and microscopical examinations made on September 20 showed typical bipolar-staining organisms. He was immediately removed to the San Lazaro plague hospital, where he died on September 22 from bubonic plague. The diagnosis was biologically confirmed. On September 6, a plague rat was found in the block next to the one in which the building in which he worked was located. A mummified plague rat was found in one of the drawers of Mr. Crozier's desk in his office. A number of fleas were seen hopping about, and one of these was captured and definitely identified at the Bureau of Science as a specimen of *Pulex cheopis*. Upon the flea being ground up and stained specimens made, a bipolar-staining organism was found. In the meantime, the mummified rat that was found in the desk was also ground up, and inoculations made into healthy laboratory rats resulted in typical cases of plague. This point is interesting for a number of reasons. In the first place, it shows that live fleas may harbor virulent plague bacilli for a period of at least two weeks, because it can be stated with certainty that the rat must have been dead for at least that period of time and probably very much longer. The possibility, of course, remains that the fleas might have come from rats that visited the drawer after the rat which was found had died. If, however, the fleas were from the dead rat which was found, it shows that fleas may live at least two weeks and harbor plague bacilli during that period. It does not seem probable that the fleas fed on the dead rat and thus ingested plague organisms after the rat's death.

In view of the foregoing findings it would appear possible that plague might be introduced into a country by infected fleas.

SANITARY MEASURES EMPLOYED

On account of the district sanitary organization which exists in Manila, no particular additional organization was required to combat the plague, except to employ a force of laborers for the purpose of catching rats and carrying out general cleaning-up

measures. The medical officer in charge of a district in which plague occurred ordered the immediate transfer of the case to the San Lazaro plague hospital and called upon the disinfecting squad to spray or wet down with kerosene the premises in which the cases occurred. This was later followed by disinfection with larvicide, a preparation which is used in Panama as a disinfectant and as a larvicide. It makes a milky solution upon being added to water. It is serviceable both as an insecticide and as a disinfectant, particularly where greasy surfaces have to be dealt with.

When a case of human or rat plague was found in a house, the house was regarded as a plague center and the infected area was arbitrarily considered to be three blocks on each side of it. Rat-catching operations were begun on the periphery of this zone and gradually directed inward until the infected house was reached. It was thought by proceeding in this manner that there was less danger of driving infected rats to other portions of the city and also that it gave the best hope of eradicating the rat infection. If an active campaign against rats in an infected house is begun, there is great danger of driving the rats away from it, or, in other words, of driving rats before the sanitary squad and thus extending the area of the rat-plague infection.

Rats were killed by means of traps and poisoned bait and by dogs and with clubs at the periphery of the zone. As the rat catchers gradually moved inward, they were immediately followed by from 50 to 100 laborers for general cleaning operations. Each house was entered. Barrels, boxes, furniture, piles of mattresses, bedding, straw, or any other things among which rats might hide were moved about and replaced in such a manner as to insure that such places were free of rats. The premises connected with the house were then treated in a similar manner. Rubbish, straw, old boxes, and other similar articles were sent away and burned at the central crematory. Wood-piles, boxes, and other articles which could not be treated in this way were taken down and neatly repiled, well above the ground and free from the wall, so that rats would be accessible. While these operations were going on, specially trained fox terriers were kept on guard, and as the rats attempted to escape from their hiding places they were caught by the dogs or clubbed to death by the laborers. Large numbers of rats, and particularly rat nests, were destroyed in this manner. As soon as these operations were completed, rat-proofing measures, so far as practi-

cable, were carried out; rat runs were obliterated; where necessary, ground surfaces were cemented; and all harboring places were destroyed wherever practicable. By the time that these operations had extended to the infected house, the sanitary engineer of the Bureau of Health made a careful inspection of the infected house and issued the necessary sanitary orders to make it rat proof. In accordance with the Manila ordinance, the Bureau of Health has authority to order even extensive structural changes in houses in which plague has occurred.

In the meantime, the sanitary force connected with the station of the district was busily engaged in making house-to-house inspections in order to ascertain whether or not there were any additional human cases. Constant inquiry was made as to whether any unusual mortality was apparent among rats. The public was particularly requested to report all dead rats found, and these were promptly taken to the laboratory.

Active steps were taken to deprive rats of their food supply. All garbage was put into metal containers covered with tight-fitting lids. Hay, oats, corn, fodder, and feed for animals generally were ordered placed in rat-proof containers.

More extensive rat catching was immediately begun in suspected areas in all other districts of Manila in order to ascertain whether there was any other rat-plague infection.

It was hoped that by employing such means, accurate information would be available for detecting an outbreak in advance and taking sanitary measures before human cases could occur.

PREVENTION OF SPREAD OF PLAGUE FROM MANILA TO THE PROVINCES

At the railway warehouses, men were stationed to inspect all cargo that was shipped from the city, and in many instances in which it was suspected of containing rats it was repacked. To prevent the spread of the disease by sea, all vessels were required to use rat guards, and fumigations were made at intervals of a few months. All lighters, cascos, and other craft used in transporting cargo from ships to shore were also included in these fumigations. All ports in the Philippines to which these vessels proceeded imposed antirat regulations against such vessels. They were required to use rat guards wherever they went alongside of docks or piers and also to undergo medical examination. Fortunately, the water front of Manila and the warehouses from which ships load did not become rat-plague infected.

FUMIGATION OF VESSELS

In the appendix will be found complete tables, by years, showing the number of vessels fumigated with sulphur in Manila since 1903 and the number of rats found on them. All of the foregoing data have been made into a consolidated table, and it is of interest to note that there is little difference between the number of rats killed per vessel as shown by the consolidated table as compared with the table for any one year, which is strong evidence that vessels must be fumigated at frequent intervals, because vessels that have been regularly fumigated are just as liable to harbor rats as vessels that have not been fumigated.

EFFECTIVENESS OF THE VARIOUS MEASURES EMPLOYED IN CATCHING RATS

The ratio maintained in catching rats with two types of traps is well shown in the following table, a perusal of which will show that for the three months ending June 30, 1913, there were 120,565 spring or snap traps set and that for every 100 of this type of trap set there were caught 6.9 rats. During the same period, there were 47,075 wire-cage traps set; the total number of rats caught was 339, which gives 0.72 rat caught for each hundred traps set. For the quarter ending September 13, 130,627 spring or snap traps were set and 9,753 rats caught, which gives 7.47 for each 100 traps set. During this period, 40,621 wire-cage traps were set and 395 rats were caught, which gives 0.97 rat caught for each 100 wire-cage traps set.

TABLE II.—*Relative efficiency of poisons and different kinds of traps used.*

Kind of trap or poison.	Quarter ending June 30.			Quarter ending September 30.		
	Number set.	Number of rats caught or poisoned.	Percentage.	Number set.	Number of rats caught or poisoned.	Percentage.
Spring or snap traps	120,565	8,377	6.900	130,627	7,753	7.47
Wire-cage traps	47,075	339	0.720	40,621	395	0.97
Poisoned bait:						
Bacon and coconuts	166,237	1,216	0.731			
Coconuts				177,309	216	0.12
Number of rats caught by dogs			160	5		
Number of rats killed by clubs and other weapons			2,889	3,818		
Number of rats found dead from other causes			316	297		

No accurate account was kept of the various forms of rat poison used. Bacon, coconut, and rice were used in different

formulas. For instance, for the quarter ending June 30, 1913, there were 166,237 poisoned baits set and the rats found poisoned averaged for each 100 baits 0.72, from which it appears that the rat poison ranks lowest in efficiency, but perhaps highest in economy. In view of the fact that the original cost of the cage trap is many times that of the spring trap and that the cost of maintenance is very high, it will be apparent that the spring trap is by far the more economical as well as more effective of the two.

MANILA RAT-PROOFING REGULATIONS

On account of the presence of plague in Manila, it was deemed most opportune to insist not only upon rat proofing in the buildings and areas which were infected, but to require rat-proof construction in all buildings which were to be erected in Manila in the future, and the following regulations have now been enforced during the past six months.

All proposed new buildings of whatever nature, whether factory, stable, garage, bodega, warehouse, private dwelling, or any other class of building, shall be designed and erected so as to have no hollow ceilings, walls, columns, stairs, floors, etc. This shall also apply to repairs or alterations to existing structures. Whenever a ceiling or hollow partition is removed, the same shall not be replaced.

Architects, builders, and others concerned are requested to incorporate the following paragraphs in plans and specifications for future buildings of this nature.

For the purpose of preventing the entrance and harboring of rats etc., this building will be constructed (or repaired) without hollow walls, hollow ceilings, hollow stairs, hollow floors, hollow columns, etc.

All walls, with the exception of solid wood framing, within 1 meter of the ground will be of concrete, brick, stone, mortar, or other material proof against the incursions of rats and will extend below the ground to a depth of at least twice the thickness of the wall.

KINDS OF RATS CAUGHT IN MANILA

From the beginning of the outbreak until September 30 there were 68,667 rats caught. At the outset, an effort was made to classify the different species of rats, but owing to the difference of opinion among those charged with the work as to the correct identification of many of the rats it is not deemed that the figures

are sufficiently reliable to quote them. However, since August 13 to September 27, 1913, rats have been classified as follows:

Gray rats, 1,103; black rats, 220; shrews, 821; unclassified, 981.

PLAGUE IN ILOILO

In Iloilo, a case suspicious of plague was reported on July 5, 1912, and this diagnosis was subsequently confirmed by the laboratory. It occurred in the person of a Chinaman who was reported to have come from Bais, Oriental Negros, but later investigation showed that he had been a resident of Iloilo at least since February, 1912. The next case was reported August 18, and the last case, September 17, 1912. There was a total of 9 cases. All of the cases were confined to two houses. During July, August, September, and October, 1,146 rats were caught in the vicinity of the houses in which the human cases had occurred, along the water front, and in the places which were regarded as suspicious, but in not a single instance was an infected rat found.

Doctor Fox, who was in charge of the antiplague measures, concluded that there was a possibility that the disease might have been imported into Iloilo, either from China or from Manila, by means of bedbugs. In view of the experience had in the death of Mr. Crozier, which occurred on September 22, 1913, it would also appear possible that plague-infected fleas might have been introduced into Iloilo and they might have been responsible for the outbreak. However, there is no scientific proof, and the actual facts as they occurred are only stated for what they are worth.

PLAGUE NOT A FILTH DISEASE

Our experience in the Philippines shows that plague is not a filth disease. A well-to-do citizen is as liable as the slum dweller to become infected if rats infect his house or other places that he frequents. In Manila, some of the worst slum sections of the city escaped; on the other hand, some of the better sections in which there were large stores of food which attract rats became infected.

PROBABLE FACTORS CONCERNED IN THE INTRODUCTION OF PLAGUE INTO THE PHILIPPINES

Much time was spent in collecting data which, it was hoped, would show in a scientific manner how plague was introduced in the Philippine Islands. In addition to the routine rat catching which has been practiced for more than ten years, immediately

after the disease made its appearance in Manila, large numbers of rats were caught along the water front and near the wharves, but none of them were found to be plague infected. The rat-proof piers at which foreign vessels lie have been all that their description implies; they have remained rat free. On account of the fact that the first cases occurred among permanent residents and among persons who had not been out of Manila in many months and who did not associate with people who worked along the water front or with persons who had recently been in a plague-infected country, it seems reasonable to infer that the disease was not introduced by human beings. As no infection could be found among the rats of the water front and especially since the wharves remained free from rats, it does not seem probable that infected rats could have come from a ship by means of gangways, cargo chutes, lines, or by other direct means. All vessels that ply in Philippine waters are fumigated at least twice annually; vessels from ports that are suspected of being infected with plague are fumigated every other trip; and vessels that carry rice or other food supplies which are especially liable to carry rats are fumigated every trip; so that the liability of plague rats coming ashore directly from ships is extremely improbable, and moreover none of the rats found in such ships in the course of the fumigation work showed any evidence of plague.

There does remain, however, the very strong probability that plague rats may have been introduced into Manila in cargo and may have made their escape therefrom after it was delivered in the city. This is possible in view of the enormous quantities of food supplies and other cargo that come directly from plague-infected centers in China and Japan. For instance, every week there are literally thousands of baskets or crates of eggs, garlic, onions, and similar foodstuffs, among which rats can easily take refuge, that come from places like Canton and Amoy within a period of five days. It is well known that plague has existed in Canton, for instance, almost continuously during the past ten years, and it is not improbable that plague rats might have been introduced into the Philippines from that port. Large quantities of cargo arrive from Japan as, for instance, glass- and china-ware, bottles, and other things which are packed in hay and straw. Among these a rat might easily have been brought into the Islands.

In a case of human plague which occurred at 508 Calle Magdalena, bedbugs were found on the petate upon which the man

died, and smears from the intestinal contents showed plague-like bacilli. From the foregoing, it would appear that perhaps infected bedbugs might be concerned in spreading the disease.

The recent experience already described in this paper, in which live fleas containing plague bacilli were found in the desk of Mr. Crozier after the rat must have been dead for at least two weeks, would also seem to make it possible that plague might have been introduced by infected fleas, although the liability of such introduction is greatly reduced because the clothing and other effects of all second- and third-class passengers are disinfected with steam.

CONSIDERATIONS WITH REGARD TO A PRACTICAL METHOD TO
PREVENT THE INTRODUCTION OF RATS OR INSECTS IN
CARGO OR PASSENGERS' EFFECTS

Since attention has been directed to the possibility of rats being present in cargo, it has been a frequent experience for customs employees and warehousemen to report rats in cargo during unpacking operations. For instance, rats are found more frequently among onions than among potatoes. Certain varieties of potatoes are much more popular with rats than others. Rats or insects that are free in the holds or other places on a ship can be eradicated fairly successfully by fumigation while the cargo is in course of being discharged or even afterward.

Experience has shown that rats that are actually concealed in cargo cannot be reached with sulphur gas with any degree of certainty while such cargo is in the hold. There is also the important consideration that when a gas is used which is sufficiently strong to penetrate the containers, there is great danger of injuring cargo like cloth, camphor, tea, etc. An effort was made to unpack all cargo liable to harbor plague rats in a rat-proof room or inclosure, but the cost was found to be prohibitive. A conference was held with the importers for the purpose of having an expression of opinion as to whether cargo liable to harbor rats could not be shipped in metal containers, but these last two procedures were declared by them to be too expensive from a commercial standpoint.

A review of the literature of plague fails to reveal any plan effectually to deal with the prevention of the introduction of rats in cargo. It is obvious that this is a most important consideration, especially when cargo can be delivered within ten days from the time that it was shipped from an infected port.

SUMMARY

After an absence of six years in human beings and five years in rats, a case of human plague was found in the Philippines on June 17, 1912. There have been a total of 68 cases and 58 deaths up to October 1, 1913, in Manila, and 9 cases and 9 deaths in Iloilo. During April, 1913, several cases of pneumonic plague were detected on vessels that came from Hongkong and Amoy. A careful investigation of these cases and of all subsequent arrivals failed to show any connection between them and the first cases of plague on June 17 in Manila. The disease was probably introduced by plague rats or insects present in cargo from infected ports which was not unpacked until it was distributed in the city. Rat catching was done in Manila during the entire time that plague was absent, but no case of rat plague was found until August 31, 1912, this in spite of the fact that over 14,000 rats had been caught in districts in which human cases had occurred since June 17. Plague was found in rats and cats and in bedbugs and fleas. An explosive human outbreak occurred in October in which 21 cases were traced to the goods warehouse at the Azcarraga railway station. The gray rats were found to be the commonest. The percentage of plague among rats has been very small, less than 0.002, whereas it is the common experience in cities in which plague occurs that at least 2 per cent of the rats are plague infected. Another most striking incident was the fact that of the total 48 plague rats which were encountered, a rat sick of plague was only found once and a rat that died of plague was only found once. The remaining rats in which plague was detected were caught in spring traps, died as a result of poison, or were clubbed to death. The transmission of plague by fleas was definitely shown by guinea pigs contracting plague from the bed of a human victim and by finding infected fleas in the desk of a human victim. Multiple house infection occurred only three times, and all of the cases were within the incubation period of the disease. Rat nests were frequently found in hollow bamboo, and the experience had in Java was fully confirmed. Seasons apparently had no influence upon the number of cases, whereas in the near-by ports of Hongkong and Amoy seasonal prevalence is most marked. The only place in the Philippines in which plague occurred outside of Manila was Iloilo. The sanitary measures employed consisted in the isolation of the plague victim in a plague hospital. The rat-catching and rat-proofing measures were begun at the periphery of a zone which extended three blocks on each side of

the house in which the plague infection had occurred, and this was apparently successful in preventing extensive spread of plague among rats. All new buildings now erected in Manila or extensive repairs in old ones must be made rat proof. A special set of building regulations for this purpose has been promulgated. Not much stress was laid upon disinfection. The principal reliance was had upon using petroleum as an insecticide. The rat-catching measures were supplemented by a general cleaning up in a suspected zone of all premises by a force of several hundred laborers, which resulted in discovering the hiding places of many rats and the destruction of rat nests. Particular attention was given to finding rat nests and destroying them, with the hope that in this way the transfer of plague-infected fleas to healthy rats would be best obviated. Dogs were extensively employed in these cleaning-up measures, and they caught many rats during the process. Manila's experience indicates that plague is not a filth disease. The spread of plague to the provinces was prevented by the inspection of all cargo that was sent out in order to be certain that it harbored no rats. From careful statistics kept with regard to the effectiveness of various forms of rat traps it was ascertained that the spring or snap is ten times as effective as the wire-cage trap and that the wire-cage trap is more effective than one portion of poison.

TABLE III.—Cases of plague.

No.	Name.	Age.	Nationality.	Sex.	Occupation.	Address.	Date—		Dis- charged.
							Found.	Died.	
1	Maximo Fernando	Yrs. 19	Filipino	Male	Laborer	920 Antonio Rivera	1912.	1912.	1912.
2	Juana Mariano	44	Filipina	Female	None	1615 Azcarraga	June 17	June 18	
3	Severino Mendoza	14	Filipino	Male	Student	37 Villalobos	June 26	June 26	
4	Francisco Castro	16	do	do	do	27 Villalobos	Aug. 4	Aug. 4	
5	Sing Nu	32	Chinese	do	Barber	417 Poblete	Aug. 7	Aug. 8	
6	Gabino Bernardo	40	Filipino	do	Messenger	686 Ilaya	Aug. 11	Aug. 13	
7	Mateo Marcelo	8	do	do	None	352 Echague	Aug. 16	Aug. 16	
8	Pedro Loyan	30	do	do	Driver	508 Magdalena	Aug. 21	Aug. 22	
9	Leong Wung	40	Chinese	do	Clerk	408 Misericordia	Sept. 24	Sept. 24	
10	Dionisio Capati	18	Filipino	do	Servant	100 Villalobos	Sept. 28	Sept. 28	
11	Asuncion Raymundo	15	Filipina	Female	Student	1149 Aceiteros	Sept. 29	Sept. 29	Nov. 2
12	Tito Almalas	39	Filipino	Male	Barber	310 Principe	Oct. 1	Oct. 5	
13	Co Mac	42	Chinese	do	Carpenter	333 San Jacinto	Oct. 9	Oct. 11	
14	Modesto Sacay	32	Filipino	do	Laborer	815 Fulgueras	Oct. 16	Oct. 16	
15	Alessandra Fischer	6	American	Female	None	598 Nozaleda	Oct. 20	Oct. 20	Nov. 3
16	Diego Reyes	22	Filipino	Male	Laborer	1067 Pedro Chaves	Oct. 21	Oct. 22	
17	Pedro Nicomedes	30	do	do	do	1476 Dagupan	Oct. 21	Oct. 22	
18	Gabriel Sevilla	21	do	do	do	1526 interior, Dagupan	Oct. 21	Oct. 21	Nov. 25
19	Jose Sarmiento	37	do	do	do	1338 interior, Dagupan	Oct. 21	Oct. 25	
20	Julian Gonzales	41	do	do	do	1482 Dagupan	Oct. 21	Oct. 23	
21	Angel Remilla	30	do	do	do	1240 Misericordia	Oct. 22	Oct. 22	
22	Valeriano Buencamino	31	do	do	do	1068 Antonio Rivera	Oct. 22	Oct. 22	
23	Policarpio Ablasa	5	do	do	None	943 Antonio Rivera	Oct. 22	Oct. 22	
24	Policarpio de Guzman	34	do	do	Laborer	421 interior, Ricafort	Oct. 22	Oct. 23	
25	Regino Gulano	34	do	do	do	129 Moriones	Oct. 22	Oct. 24	
26	Martin Dimalanta	35	do	do	do	419 Elcano	Oct. 22	Oct. 24	

27	Roberto Obiso	do	do	do	do	1871 interior, Anloague	Oct. 23	Oct. 25
28	Juan Barceta	do	do	do	do	362 Elcano	Oct. 23	Oct. 24
29	Yu Tun	Chinese	do	do	House boy	828 Lavarezas	Oct. 24	Oct. 25
30	Domingo Cariago	Filipino	do	do	Laborer	223 Azcarraga	Oct. 24	Oct. 24
31	Pastor de la Cruz	do	do	do	do	243 Concha	Oct. 28	Oct. 28
32	Agustin Monterey	do	do	do	Cargador	911 Antonio Rivera	Nov. 1	Nov. 2
33	Feliciano Garcia	do	do	do	Collector	1233 Arlegui	Nov. 5	Nov. 5
34	Guillermo Vitubina	do	do	do	Silversmith apprentice	804 San Fernando	Nov. 11	Nov. 11
35	Fidel Javier	do	do	do	Messenger	716 General Solano	Nov. 13	Nov. 13
36	Maria Ebarido	Filipina	Female	do	Seamstress	806 San Fernando	Nov. 13	Nov. 13
37	Norberto Ortiz	Filipino	Male	do	Capataz	506 Economia	Nov. 14	Dec. 1
38	Magdalena Villarante	do	do	do	Laborer	1128 Dagupan	Nov. 15	Nov. 15
39	Buenaventura Evangelista	do	do	do	None	808 San Fernando	Nov. 15	Nov. 15
40	Demetrio Pabraw	do	do	do	Tailor	84 San Fernando	Nov. 22	Nov. 23
41	Alejandro Gita	do	do	do	None	290 Cabildo	Nov. 23	Nov. 24
42	Esteban Roa	do	do	do	Laborer	1953 interior, Anloague	Nov. 26	1913.
43	Juana Clemente	Filipina	Female	do	Dressmaker	805 Jaboneros	Nov. 27	Jan. 28
44	Juan Conlas	Filipino	Male	do	Laborer	972 Benavides	Dec. 1	Dec. 1
45	Siu Su	Chinese	do	do	do	518 Teodora Alonzo	Dec. 2	Jan. 5
46	Ambrosio Sobremonte	Filipino	do	do	Servant	522 Madrid	Dec. 7	Dec. 7
47	Purificacion del Val	Filipina	Female	do	Housewife	284 Cabildo	Dec. 11	Jan. 16
48	Alejandra Laurente	do	do	do	do	4 Barraca	Dec. 16	Dec. 16
49	Barbara Lim	do	do	do	None	282 Estero de Binondo	Dec. 25	Dec. 25
50	Bo Hong Bang	Chinese	Male	do	Laborer	96 Isla de Romero	1913.	1913.
51	Pedro Marco	Filipino	do	do	Student	121 Aguila	Jan. 24	Jan. 28
52	Chug Tan	Chinese	Female	do	None	1023 Comercio	Feb. 8	Feb. 8
53	Chug Kek	do	Male	do	Laborer	503 Elcano	Feb. 12	Feb. 18
54	Candido Zamora	Filipino	do	do	Sculptor	1268 Arlegui	Feb. 18	Feb. 18
55	Esteban Masibag	do	do	do	Laborer	140 Perla	Mar. 6	Mar. 6
56	Felix Santos	do	do	do	do	12 Aguila, Tondo	Mar. 21	Mar. 22

^a Months.

TABLE III.—Cases of plague—Continued.

No.	Name.	Age. Yrs.	Nationality.	Sex.	Occupation.	Address.	Date—		Dis- charged.
							Found.	Died.	
57	Jose Raymundo	16	Filipino	Male	Silversmith	334 P. Rada	1913. Mar. 25	1913. Mar. 25	1912.
58	Paulina Mariano	17	Filipina	Female	Housewife	12 Aguila	Mar. 28	Mar. 29	
59	Norberta Mendoza	56	do	do	None	1419 interior, Dagupan	Apr. 26	Apr. 26	
60	Trinidad Galvez	16	do	do	None	1364 Sande	Apr. 26	Apr. 26	
61	Pablo Banzon	26	Filipino	Male	Silversmith	646 Ilaya	Apr. 26	Apr. 27	
62	Simplicio Enriquez	27	do	do	do	1492 interior, Dagupan	Apr. 27	Apr. 30	
63	Emilio Laron	28	do	do	Farmer	213 interior, Perla	Apr. 30	Apr. 30	
64	Valeriano Lausin	14	do	do	None	917-919 Jaboneros	May 14	June 14	
65	Filomena Sunga	19	Filipina	Female	None	1226 Juan Luna	May 15	May 27	
66	Juan Carreon	21	Filipino	Male	Laborer	788 Santa Maria	May 21	June 28	
67	Julian Tapawan	38	do	do	Policeman	721 Velasquez	Aug. 27	Sept. 11	
68	William Crozier	43	American	do	Editor	346 Kansas	Sept. 20	Sept. 22	

TABLE IV.—*Plague-infected rats. Reported by the Bureau of Science. Bacteriological examination, positive.*

No.	Where found.	Date.	How caught.
1	351 San Sebastian	Aug. 30, 1912	Poison.
2	104 Santa Rosa	Sept. 6, 1912	Spring trap.
3	215 Echague.....	Sept. 6, 1912	Do.
4	520 Jaboneros.....	Oct. 16, 1912	Poison.
5	157 Estero de Binondo.....	Dec. 19, 1912	Spring trap.
6	657 Cabildo (Intramuros).....	Dec. 23, 1912	Do.
7	157 Estero de Binondo.....	Dec. 26, 1912	Do.
8	319 Estero Cegado	Feb. 20, 1913	Do.
9	203 Sardinias	Mar. 7, 1913	Do.
10	857 Elcano	Mar. 7, 1913	Do.
11	204 Concha	Mar. 9, 1913	Do.
12	200 Padre Rada.....	Mar. 9, 1913	
13	1331 Sande.....	Mar. 12, 1913	Club.
14	245 Perla	Mar. 13, 1913	Poison.
15	101 Coral	Mar. 13, 1913	Do.
16	1316 Sande.....	Mar. 16, 1913	Spring trap.
17	1001 Pesqueria.....	Mar. 19, 1913	Other causes.
18	232 Concha	Mar. 26, 1913	Other weapon.
19	1420 Sande.....	Mar. 29, 1913	Poison.
20	323 Pavia	Mar. 29, 1913	Do.
21	1383 Anloague	Mar. 31, 1913	Do.
22	538 T. Alonzo (Int. 1).....	Apr. 3, 1913	Spring trap.
23	816 Pesqueria.....	Apr. 6, 1913	Poison.
24	1617 Sande (Int. 14)	May 1, 1913	Spring trap.
25	1649 Sande.....	May 6, 1913	Do.
26	851 Ilaya.....	May 8, 1913	Do.
27	677 Tanduary.....	May 9, 1913	Do.
28	207 Velasquez	Apr. 18, 1913	Club.
29	Palumpung.....	May 14, 1913	Unknown.
30	1811 Juan Luna (Int. 2)	May 20, 1913	
31	220 Tetuan.....	May 20, 1913	Spring trap.
32	627 Velasquez	June 9, 1913	Do.
33	447 Conservador (Int.)	June 15, 1913	Found dead (with plague).
34	1903 Juan Luna.....	June 25, 1913	Spring trap.
35	210 Chica	Sept. 6, 1913	Found dead.
36	537 Peñarubia	Sept. 11, 1913	Spring trap.
37	530 Rivera	Sept. 11, 1913	Do.
38	Stewart Building.....	Sept. 19, 1913	Found dead.
Cat	United States warehouse, Mal- econ and Pasig River.	Nov. 30, 1912	Found sick.

TABLE V.—Rats destroyed on vessels by sulphur fumigation.

(Calendar year 1904.)

Month.	Number of rats on—				Number of vessels—		
	Steamers.	Schooners.	River craft.	All vessels.	Having rats.	Having no rats.	Fumigated.
January	0	0	0	0	0	0	0
February	0	0	0	0	0	0	0
March	0	0	0	0	0	0	0
April.....	461	25	4	490	38	6	44
May.....	155	106	0	261	51	45	96
June.....	153	19	0	172	20	12	32
July.....	6	25	0	31	8	20	28
August.....	164	9	0	173	7	13	20
September.....	83	0	0	83	1	18	19
October.....	146	0	0	146	11	10	21
November.....	260	10	0	270	20	15	35
December.....	85	9	0	94	8	4	12
Total.....	1,513	203	4	1,720	164	143	307

TABLE VI.—Kinds of vessels on which rats were destroyed.

(Calendar year 1903.)

Kind.	Vessels.			Rats.			Percentage of vessels having rats.
	Total.	Having rats.	Having no rats.	Total.	Average in all vessels.	Average in vessels having rats.	
Steamers	168	99	69	1,513	9.00	15.28	58.93
Schooners.....	134	63	71	203	1.51	3.22	47.01
River craft.....	5	2	3	4	0.80	2.00	40.00
All vessels.....	307	164	143	1,720	5.60	10.49	53.42

TABLE VII.—Rats destroyed on vessels by sulphur fumigation.

(Calendar year 1903.)

Month.	Number of rats on—				Number of vessels—		
	Steamers.	Schooners.	River craft.	All vessels.	Having rats.	Having no rats.	Fumigated.
January	112	48	0	160	29	23	52
February	26	19	0	45	9	26	35
March	38	16	0	54	9	17	26
April.....	10	14	2	26	7	17	24
May.....	246	10	0	256	19	8	27
June.....	236	5	0	241	15	5	20
July.....	46	35	3	84	12	4	16
August.....	274	18	0	292	13	8	21
September.....	65	24	0	89	14	5	19
October.....	327	9	4	340	9	10	19
November.....	12	21	0	33	13	5	18
December.....	81	6	0	87	14	3	17
Total.....	1,473	225	9	1,707	163	131	294

TABLE VIII.—Kinds of vessels on which rats were destroyed.

(Calendar year 1904.)

Kind.	Vessels.			Rats.			Percentage of vessels having rats.
	Total.	Having rats.	Having no rats.	Total.	Average in all vessels.	Average in vessels having rats.	
Steamers.....	154	105	49	1,473	9.56	13.03	68.18
Schooners.....	134	54	80	225	1.68	4.17	40.30
River craft.....	6	4	2	9	1.50	2.25	60½
All vessels.....	294	163	131	1,707	5.80	10.47	55.40

TABLE IX.—Rats destroyed on vessels by sulphur fumigation.

(Calendar year 1905.)

Month.	Number of rats on—				Number of vessels—		
	Steamers.	Schooners.	River craft.	All vessels.	Having rats.	Having no rats.	Fumigated.
January.....	24	15	1	40	12	6	18
February.....	53	3	0	56	8	9	17
March.....	141	23	0	164	19	13	32
April.....	125	18	0	143	17	4	21
May.....	22	3	0	25	5	8	13
June.....	96	26	0	122	12	3	15
July.....	72	11	0	83	11	8	19
August.....	23	0	0	23	4	4	8
September.....	69	0	0	69	5	2	7
October.....	35	9	0	44	13	2	15
November.....	18	3	0	21	6	1	7
December.....	0	0	0	0	0	0	0
Total.....	678	111	1	790	112	60	172

TABLE X.—Kinds of vessels on which rats were destroyed.

(Calendar year 1905.)

Kind.	Vessels.			Rats.			Percentage of vessels having rats.
	Total.	Having rats.	Having no rats.	Total.	Average in all vessels.	Average in vessels having rats.	
Steamers.....	109	72	37	678	6.22	9.42	66.05
Schooners.....	62	39	23	111	1.80	2.87	62.90
River craft.....	1	1	0	1	1.00	1.00	100.00
All vessels.....	172	112	60	790	4.60	7.05	65.11

TABLE XI.—Rats destroyed on vessels by sulphur fumigation.

(Calendar year 1906.)

Month.	Number of rats on—				Number of vessels—		
	Steamers.	Schooners.	River craft.	All vessels.	Having rats.	Having no rats.	Fumigated.
January	10	0	0	10	1	0	1
February	0	0	0	0	0	1	1
March	10	5	0	15	3	0	3
April	0	0	15	15	1	2	3
May	2	0	0	2	1	1	2
June	169	2	0	171	19	0	19
July	205	0	0	205	14	0	14
August	56	9	0	65	12	1	13
September	7	23	0	30	3	0	3
October	58	12	0	70	8	1	9
November	23	0	0	23	2	0	2
December	8	1	0	9	3	0	3
Total	548	52	15	615	67	6	73

TABLE XII.—Kinds of vessels on which rats were destroyed.

(Calendar year 1906.)

Kind.	Vessels.			Rats.			Percentage of vessels having rats.
	Total.	Having rats.	Having no rats.	Total.	Average in all vessels.	Average in vessels having rats.	
Steamers	59	55	4	548	9.30	9.98	93.22
Schooners	13	11	2	52	4.00	4.73	84.61
River craft	1	1	0	15	15.00	15.00	100.00
All vessels	73	67	6	615	8.42	9.18	91.78

TABLE XIII.—Rats destroyed on vessels by sulphur fumigation.

(Calendar year 1907.)

Month.	Number of rats on—				Number of vessels—		
	Steamers.	Schooners.	River craft.	All vessels.	Having rats.	Having no rats.	Fumigated.
January	20	1	0	21	2	0	2
February	67	12	0	79	8	1	9
March	110	11	0	121	26	1	27
April	262	14	1	277	18	0	18
May	66	6	40	112	10	1	11
June	28	0	0	28	2	1	3
July	38	0	0	38	5	8	13
August	24	0	0	24	4	2	6
September	0	13	0	13	1	3	4
October	37	2	0	39	7	5	12
November	51	10	0	61	12	2	14
December	14	4	0	18	4	0	4
Total	717	73	41	831	99	24	123

TABLE XIV.—*Kinds of vessels on which rats were destroyed.*

(Calendar year 1907.)

Kind.	Vessels.			Rats.			Percentage of vessels having rats.
	Total.	Having rats.	Having no rats.	Total.	Average in all vessels.	Average in vessels having rats.	
Steamers.....	91	77	14	717	7.88	9.31	84.61
Schooners.....	25	20	5	73	2.92	3.65	80.00
River craft.....	7	2	5	41	5.85	20.50	28.57
All vessels.....	123	99	24	831	6.75	8.40	80.50

TABLE XV.—*Rats destroyed on vessels by sulphur fumigation.*

(First half of calendar year 1908.)

Month.	Number of rats on—				Number of vessels—		
	Steamers.	Schooners.	River craft.	All vessels.	Having rats.	Having no rats.	Fumigated.
January.....	188	3	0	191	9	0	9
February.....	118	7	0	125	10	1	11
March.....	59	2	0	61	5	0	5
April.....	16	0	2	18	2	2	4
May.....	17	2	0	19	4	1	5
June.....	91	6	0	97	8	1	9
Total.....	489	20	2	511	38	5	43

TABLE XVI.—*Kinds of vessels on which rats were destroyed.*

(Calendar year 1908.)

Kind.	Vessels.			Rats.			Percentage of vessels having rats.
	Total.	Having rats.	Having no rats.	Total.	Average in all vessels.	Average in vessels having rats.	
Steamers.....	31	27	4	489	15.78	18.01	87.10
Schooners.....	11	10	1	20	1.82	2.00	90.90
River craft.....	1	1	0	2	2.00	2.00	100.00
All vessels.....	43	38	5	511	11.88	13.45	88.37

TABLE XVII.—Rats destroyed on vessels by sulphur fumigation.

(Fiscal year 1909.)

Month.	Number of rats on—				Number of vessels—		
	Steamers.	Schooners.	River craft.	All vessels.	Having rats.	Having no rats.	Fumigated.
July	152	74	0	226			38
August	73	0	7	80			14
September	24	0	0	24			9
October	29	4	0	33			8
November	30	0	0	30			5
December	42	0	0	0			8
January	7	4	0	11			5
February	22	0	0	22			7
March	51	0	0	51			8
April	38	2	0	40			9
May	45	6	0	51			9
June	116	0	0	116			6
Total	629	90	7	726			126

TABLE XVIII.—Kinds of vessels on which rats were destroyed.

(Fiscal year 1909.)

Kind.	Vessels.			Rats.			Percentage of vessels having rats.
	Total.	Having rats.	Having no rats.	Total.	Average in all vessels.	Average in vessels having rats.	
Steamers	108	76	32	629	5.82	8.30	70.53
Schooners	17	12	5	90	5.29	7.50	70.60
River craft	1	1	0	7	7.00	7.00	100.00
All vessels	126	89	37	726	5.76	8.15	70.63

TABLE XIX.—Rats destroyed on vessels by sulphur fumigation.

(Fiscal year 1910.)

Month.	Number of rats on—				Number of vessels—		
	Steamers.	Schooners.	River craft.	All vessels.	Having rats.	Having no rats.	Fumigated.
July	4	0	0	4			3
August	10	0	0	10			3
September	18	7	0	25			5
October	298	0	0	298			10
November	12	0	0	12			3
December	60	0	0	60			7
January	22	16	0	38			8
February	102	0	9	111			14
March	424	9	31	464			58
April	234	67	5	306			44
May	350	0	0	350			15
June	100	0	5	105			3
Total	1,634	99	50	1,783			183

TABLE XX.—Kinds of vessels on which rats were destroyed.
(Fiscal year 1910.)

Kind.	Vessels.			Rats.			Percentage of vessels having rats.
	Total.	Having rats.	Having no rats.	Total.	Average in all vessels.	Average in vessels having rats.	
Steamers.....	109	88	21	1,634	15.00	18.57	80.7
Schooners.....	32	16	16	99	3.10	6.20	50.0
River craft.....	42	18	24	50	1.20	2.77	43.0
All vessels.....	183	122	61	1,783	9.74	14.62	66½

TABLE XXI.—Rats and mice destroyed on vessels by sulphur fumigation.
(Fiscal year 1911.)

Month.	Found in—											
	Steamers.			Schooners.			Lanuches.			All vessels.		
	Mice.	Rats.	Rats and mice.	Mice.	Rats.	Rats and mice.	Mice.	Rats.	Rats and mice.	Mice.	Rats.	Rats and mice.
July.....	23	101	124	21	8	29	0	0	0	44	109	153
August.....	67	196	263	3	4	7	2	2	4	72	202	274
September.....	45	223	268	7	7	14	0	0	0	52	230	282
October.....	9	130	139	0	0	0	4	4	8	13	134	147
November.....	3	39	42	20	6	26	0	0	0	23	45	68
December.....	14	30	44	1	5	6	0	0	0	15	85	50
January.....	105	396	501	50	74	124	22	77	99	177	547	724
February.....	46	91	137	19	36	55	3	9	12	68	136	204
March.....	60	65	125	12	12	24	1	1	2	73	78	151
April.....	14	269	283	12	8	20	0	0	0	26	277	303
May.....	115	103	218	7	12	19	0	0	0	122	115	237
June.....	25	159	184	3	9	12	2	4	6	30	172	202
Total.....	526	1,802	2,328	155	181	336	34	97	131	715	2,080	2,795

TABLE XXII.—Kinds of vessels on which rats and mice were destroyed.
(Fiscal year 1911.)

Kind of vessels.	Number of vessels.			Number of—			Average number in all vessels.			Average number in vessels having rats.			Percentage of vessels having rats.
	Total.	Having rats.	Having no rats.	Mice.	Rats.	Rats and mice.	Mice.	Rats.	Rats and mice.	Mice.	Rats.	Rats and mice.	
Steamers...	170	145	25	526	1,802	2,328	3.09	10.60	13.69	3.63	12.43	16.06	85.300
Schooners...	64	62	2	155	181	336	2.42	2.83	5.25	2.50	2.92	5.42	96.875
Lanuches...	33	32	1	34	97	131	1.03	2.94	3.97	1.06	3.03	4.09	97.000
All vessels...	267	239	28	715	2,080	2,795	2.67	7.79	10.46	3.00	8.70	11.70	89.500

TABLE XXIII.—Rats destroyed on vessels by sulphur fumigation.
(Fiscal year 1912.)

Month.	Found in—												Vessels fumi- gated.		
	Steamers.			Schooners.			River craft.			All vessels.			Having rats.	No rats.	Total.
	Mice.	Rats.	Rats and mice.	Mice.	Rats.	Rats and mice.	Mice.	Rats.	Rats and mice.	Mice.	Rats.	Rats and mice.			
July	51	165	216	6	49	55	4	16	20	61	230	291	24	5	29
August ...	125	211	336	5	9	14	14	11	25	144	231	375	40	6	46
September	51	98	149	37	46	83	4	7	11	92	151	243	25	9	34
October ...	66	75	141	3	0	3	0	0	0	69	75	144	11	2	13
November	46	87	133	174	32	206	0	1	1	220	120	340	16	1	17
December..	45	174	219	1	7	8	0	0	1	46	181	227	13	7	20
January ..	22	108	130	17	16	53	6	14	20	45	158	203	36	11	47
February ..	100	193	293	9	10	19	0	0	0	109	203	312	22	5	27
March	84	459	543	3	5	8	4	5	9	91	469	560	29	10	39
April.....	70	256	326	10	16	26	3	0	3	83	272	355	18	6	24
May.....	27	170	197	40	38	78	1	4	5	68	212	280	25	4	29
June.....	25	37	62	0	8	8	4	7	11	29	52	81	13	7	20
Total..	712	2,033	2,745	305	256	561	40	65	105	1,057	2,354	3,411	272	73	345

TABLE XXIV.—Kinds of vessels on which rats and mice were destroyed.
(Fiscal year 1912.)

Kind of vessel.	Number of vessels.			Number of—			Average number in all vessels.			Average number in vessels having rats.			Percent- age of vessels having rats.
	Total.	Hav- ing rats.	Hav- ing no rats.	Mice.	Rats.	Rats and mice.	Mice.	Rats.	Rats and mice.	Mice.	Rats.	Rats and mice.	
Steamers....	223	175	48	712	2,033	2,745	3.19	9.12	12.31	4.07	11.62	15.69	78.48
Schooners...	72	57	15	305	256	561	4.24	3.55	7.79	5.35	4.49	9.84	79.17
River craft ..	50	40	10	40	65	105	0.80	1.30	2.10	1.00	1.62	2.62	80.00
All vessels..	345	272	73	1,057	2,354	3,411	3.06	6.82	9.88	3.89	8.65	12.54	78.84

TABLE XXV.—Rats destroyed on vessels by sulphur fumigation.

(Fiscal year 1913.)

Month.	Found in—											
	Steamers.			Schooners.			River craft.			All vessels.		
	Mice.	Rats.	Rats and mice.	Mice.	Rats.	Rats and mice.	Mice.	Rats.	Rats and mice.	Mice.	Rats.	Rats and mice.
July	71	114	185	11	23	34	0	6	6	32	143	225
August	35	84	119	0	0	0	0	2	2	35	87	^a 121
September	39	154	193	16	21	37	0	12	12	55	189	^b 242
October	78	145	223	4	16	20	37	89	126	119	250	369
November	149	82	231	12	12	24	30	103	133	191	197	388
December	21	270	291	0	1	1	12	67	79	33	338	371
January	1	12	13	3	0	3	1	6	7	5	18	23
February	6	44	50	0	1	1	1	0	1	7	45	52
March	19	25	44	3	1	4	0	0	0	22	26	48
April	14	150	164	0	5	5	0	20	20	14	175	189
May	26	178	204	0	12	12	0	3	3	26	193	219
June	21	140	161	2	3	5	7	0	7	30	143	173
Total	480	1,398	1,878	51	95	146	88	308	396	619	1,804	2,423

^a Plus 1 found on wharf.^b Plus 2 found on wharf.

TABLE XXVI.—Kinds of vessels on which rats and mice were destroyed.

(Fiscal year 1913.)

Kind of vessel.	Number of vessels.			Number of—			Average number in all vessels.			Average number in vessels having rats.			Percentage of vessels having rats.
	Total.	Having rats.	Having no rats.	Mice.	Rats.	Rats and mice.	Mice.	Rats.	Rats and mice.	Mice.	Rats.	Rats and mice.	
Steamers	225	173	52	480	1,398	1,878	2.13	6.21	8.34	2.75	8.08	10.83	76.89
Schooners	53	29	24	51	95	146	0.96	1.79	2.75	1.76	3.27	5.03	54.72
River craft	320	129	191	88	308	396	0.27	0.96	1.23	0.68	2.39	3.07 ^a	40.30
All vessels	598	331	267	619	1,804	2,423	1.03	3.02	4.05	1.93	5.62	7.55	53.68

TABLE XXVII.—Rats destroyed on vessels by sulphur fumigation.

(January 1, 1903, to June 30, 1913.)

Kind of vessel.	Number of vessels.			Rate.			Percentage of vessels having rats.
	Total.	Having rats.	Having no rats.	Total.	Average number in all vessels.	Average number in vessels having rats.	
Steamers	1,447	1,092	355	14,632	10.11	13.40	75.47
Schooners	617	373	244	1,916	3.10	5.14	60.45
River craft	467	231	236	761	1.63	3.30	49.46
All vessels	2,531	1,696	835	^a 17,312	6.84	10.80	67.00

^a Three found on wharf.

ILLUSTRATION

MAP 1. Map of Manila, showing the location of plague cases in 1912-1913.

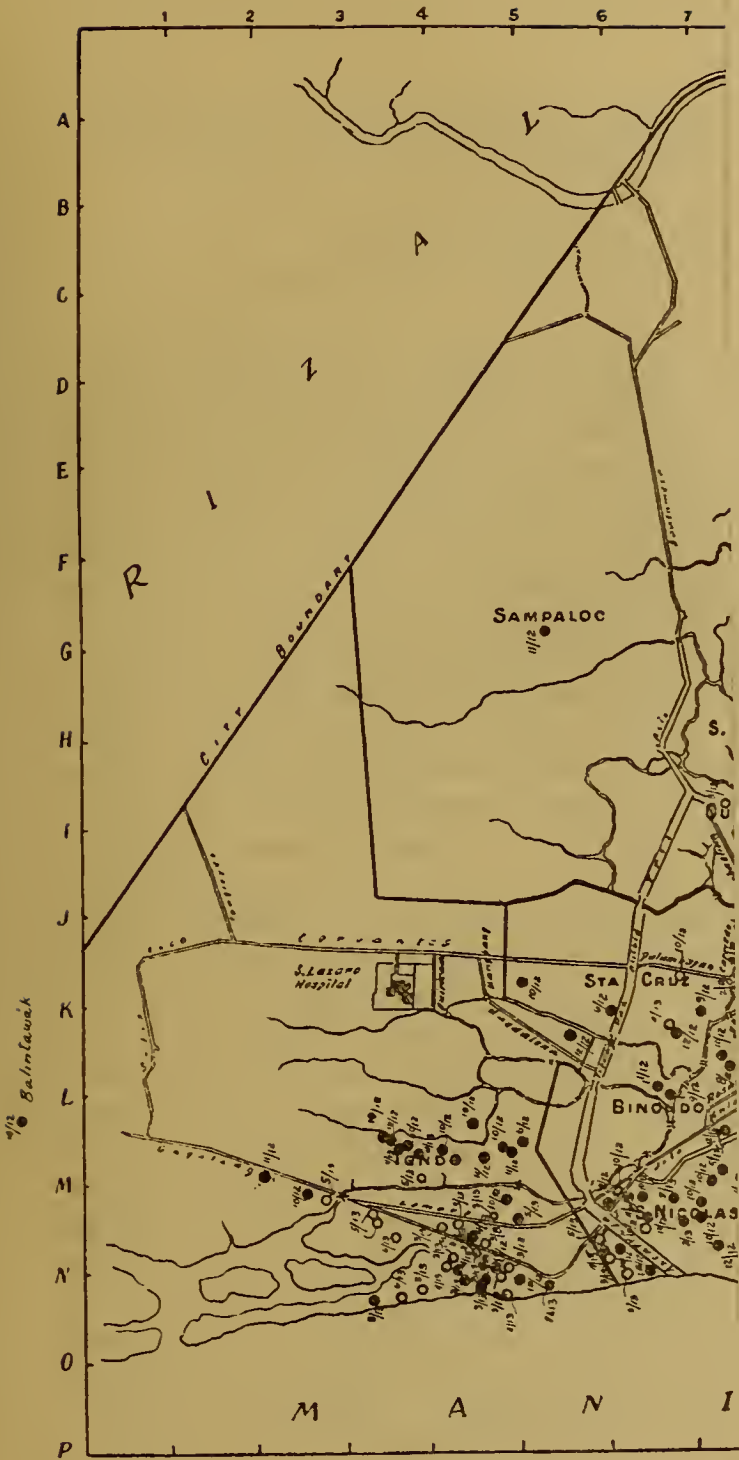

MAP I. MANILA, SHOWING



MAP I. MANILA, SHOWING THE LOCATION OF PLAGUE CASES IN 1912-1913.

A PRELIMINARY REPORT OF EXPERIMENTS ON THE CULTIVATION OF THE VIRUS OF RINDERPEST IN VITRO

By WILLIAM HUTCHINS BOYNTON

(From the Veterinary Division,¹ Bureau of Agriculture, Manila, P. I.)

The literature on rinderpest contains numerous reports of investigations carried on with the object of isolating the causative agent of that disease. Tartacovsky(1) gives a thorough review of the results obtained by numerous workers up to 1896. Nencki, Sieber, and Wijnikewitch(2) in 1898 published a paper on the etiological agent of rinderpest, but their conclusions have not been verified. They did, however, report success in maintaining the virus in vitro to the fourth generation. No explicit statement was made regarding the time covered by these four generations, but the writers observed that it is best to transfer cultures every three days. Koch(3) in 1897 in the second report of his investigations in South Africa on the etiology of rinderpest states that all his efforts to isolate and cultivate the virus of rinderpest were fruitless.

In the present report there will be given merely a summary of the preliminary experiments which have been carried on at the veterinary research laboratory at Alabang and which have led up to the present work.

It was observed from various experiments that the causative agent of rinderpest remained alive and maintained its virulence much longer under anaërobic than when under aërobic conditions. The medium used in these earlier experiments was principally virulent blood drawn under aseptic conditions from animals suffering with the disease. It was noted that blood drawn from an animal in the early stages of the disease—that is, from one to three days after the initial rise of temperature—maintained its virulence much longer than blood drawn from an animal in the later stages of the disease, near the point of recovery or of death. Undoubtedly the antibodies present in the samples of blood play an important rôle in the last-mentioned condition.

¹ Archibald R. Ward, chief.

The next step was to locate, if possible, the blood element which harbored the virus. For assistance in this work, I am greatly indebted to Dr. M. A. Barber of the Bureau of Science. Doctor Barber used his pipette method for the isolation of single microorganisms to pick out and separate the different blood elements.

Two susceptible animals received, respectively, 200 and 255 red blood cells from an animal sick with rinderpest. The animals were unaffected by the injections, and at a later date they were proved to be susceptible. Two animals were injected with 15 and 40 leucocytes, respectively, obtained from the blood of infected animals. They were unaffected by the injections, but later were proved to be susceptible. Three animals were injected with blood platelets. They received, respectively, 6,000, 770, and a large number, the exact count not determined. These animals remained well, but later were proved to be susceptible. The blood from which these elements were taken was checked in each case and found to be virulent.

The question then arose, does the virus occur as thickly distributed in the blood of an infected animal as was previously supposed. Therefore, it became necessary to determine the smallest dose of whole blood that would cause the disease. Fine capillary pipettes were made, and a certain length was marked on the glass. The weight of mercury filling this designated portion was compared with the weight of 1 cubic centimeter of mercury. In this way the capacity of the minute quantity defined by the mark on the capillary tube was approximately obtained. It was found that $\frac{1}{2970}$ cubic centimeter of virulent blood transmitted the disease to a susceptible animal, but $\frac{1}{9060}$ cubic centimeter and 0.0001 cubic centimeter of virulent blood failed to transmit the disease. The susceptibility of these animals was proved later. These results gave an approximate indication of the minimum amount of virulent blood which would transmit the disease and were an aid in the culture work for comparison with the dilution of the original blood brought about by successive transfers in culture media.

The final step was to find a medium in which the virus would remain alive and multiply. Many unsuccessful attempts were made using various kinds of media. The virus would either die or at least lose its virulence in from thirty-six to sixty-eight hours. In no case was the second tube of medium shown to contain virus. Finally, apparently positive results were obtained by modifying slightly the medium described by Nencki, Sieber,

and Wijnikewitch⁽²⁾ and with the medium used by Bass and Johns.⁽⁴⁾ This report is based upon work with these modified media.

TECHNIQUE

The first medium tested was a salt-peptone preparation advocated by Nencki, Sieber, and Wijnikewitch. It is composed of 900 cubic centimeters of water to which are added 100 grams of peptone Witte and 20 grams of sodium chloride. The mixture is filtered, placed in test tubes, and sterilized. I have been unable to obtain successful results in the cultivation of rinderpest virus in the medium described. This medium was modified by adding 0.1 cubic centimeter of a 33 $\frac{1}{3}$ per cent solution of glucose to each 10 cubic centimeters of the salt-peptone mixture described by Nencki, Sieber, and Wijnikewitch. Test tubes 1.5 centimeters in diameter and 15 centimeters long were employed. The glucose solution to the amount of 0.1 centimeter was added to each tube, and to this were added 10 cubic centimeters of the salt-peptone solution. It was sterilized for one hour in an autoclave at 135° C. on the day previous and one-half hour just prior to inoculation. Normal blood was drawn under aseptic conditions from a nonimmune animal and defibrinated by shaking with glass beads. One cubic centimeter of this blood was added to each tube immediately before it was inoculated. Blood from an animal suffering with rinderpest was then drawn under aseptic conditions and defibrinated. Each tube was inoculated with either 0.5 or 1 cubic centimeter of the infective blood. Anaërobic conditions were produced by covering the surface of the inoculated media with from 1.5 to 2 cubic centimeters of sterile paraffin oil. The tubes were then placed in the incubator at 40° C.

In making transfers, a sterile pipette of 1 cubic centimeter capacity was inserted into the culture tube from which the transfer was to be made and the medium was thoroughly agitated by filling the pipette with the medium and emptying. This was repeated four or five times. Then either 0.3 or 0.5 cubic centimeter of the culture was transferred to the prepared culture medium, after which the tubes were sealed with paraffin oil and placed in the incubator. It was found best to make these transfers every three or four days.

The medium which has given the best results is a modification of the one used by Bass and Johns for cultivating the plasmodium of malaria. To each of a series of test tubes was

added 0.1 cubic centimeter of a 33 $\frac{1}{3}$ per cent glucose solution. These tubes were then placed in the autoclave and sterilized. Ten cubic centimeters of normal defibrinated blood from a susceptible animal were then added to each tube, which was immediately inoculated with 0.5 cubic centimeter of defibrinated blood from an animal suffering with rinderpest. Each culture was then covered with from 1.5 to 2 cubic centimeters of sterile paraffin oil, and was placed in the incubator at 40° C.

In making transfers, a sterile pipette of 1 cubic centimeter capacity was inserted into the medium from which the transfers were to be made and the culture was agitated by filling the pipette with medium and emptying several times. Either 0.3 or 0.5 cubic centimeter of the culture was transferred into the blood-glucose tubes, which were then sealed with sterile paraffin oil and placed in the incubator.

I have found it best to make transfers every three or four days as the virus in culture media has a tendency to lose its virulence or die after remaining several days in one tube.

In one series in salt-peptone mixture the virus in the primary tube of culture medium lost its virulence on the sixth day, while I was able to carry the same strain alive through four transfers, covering a period of thirteen days.

During the months of July, August, and September, 1913, I have twice succeeded in carrying the virus in virulent form in the glucose-blood medium to the sixth transfer, covering periods of nineteen and twenty-one days, respectively. I have twice succeeded in carrying the virus in virulent form in the salt-peptone mixture to the fourth transfer covering periods of twelve and thirteen days, respectively.

In one series the fifth transfer from glucose blood medium was carried into the salt-peptone mixture which was allowed to incubate three days and proved virulent when injected into a susceptible animal. These six transfers in culture media cover a period of eighteen days after the virus was taken from the infected animal.

The question then arose whether there was really a multiplication of the virus in these media or whether the original blood was transferred from one tube to another up to the sixth transfer in sufficient quantity to cause the disease when injected into a susceptible animal. In one of the series in which the sixth transfer proved virulent, 0.3 cubic centimeter of the culture was used in making the transfer each time. In computing the dilution of the original virulent blood in the sixth transfer, it was

found to be approximately $\frac{1}{2832921}$ cubic centimeter. From the experiments quoted above it was found that $\frac{1}{9060}$ and 0.0001 cubic centimeter of fresh virulent blood failed to transmit the disease. Therefore, it appears that there was a multiplication of the virus in the culture tubes, since the dilution of the original virulent blood that resulted from the successive transfers was so much greater than the quantity which was found necessary to produce the disease. In one series I was not able to reproduce the disease from the medium first inoculated after twelve days, but the fourth transfer corresponding to a period of twelve days after removal from the sick animal proved virulent. This would suggest that the virus continued to live in the transfers, but died out, or lost its virulence, in the original tube of culture medium.

In the salt-peptone medium myriads of minute bodies could be seen under dark field illumination, especially in transfers of the first and second generations. A large number of check examinations have been made with normal blood. In some instances bodies practically identical with those found in cultures made from virulent blood are found. Therefore, at present, nothing can be stated concerning the morphology of the etiological factor. In the salt-peptone medium there appears a perceptible cloudiness above the blood on the bottom of the tube.

Up to the present time the best results have been obtained by taking blood from an animal in the early stages of the disease; that is, about the second day of temperature. All animals employed to test the existence of rinderpest virus in culture media were kept under such conditions as to warrant the belief that no accidental infection occurred to cause fallacious conclusions.

The greatest precaution must be taken against contamination, since the media are composed chiefly of raw blood which cannot be sterilized. I have twice lost the seventh transfer on account of bacterial contamination, which appears to kill the virus in a very short time. The presence of contaminative bacteria is usually revealed by a pellicle immediately beneath the paraffin oil.

One animal which was inoculated with the fourth transfer recovered from the disease. This animal is at present being hyperimmunized with cultures, with the intention, in the near future, of testing the potency of its serum as compared with serum from animals immunized with virulent blood. Experiments are being carried on to determine if it is possible to produce a toxin in culture and to prepare an antitoxin. Work

is also under way to determine the practicability of substituting cultures of rinderpest virus for virulent blood in simultaneous inoculations.

The results obtained present a wide range of possibilities for the improvement of the present technique of immunization and for the determination of the etiological factor, which may revise the present methods of combating the disease.

SUMMARY

1. From the results obtained from various experiments it is evident that the virus of rinderpest requires either partial or complete anaërobic conditions for its existence.

2. The virus of rinderpest has been carried in virulent form in two separate series up to the sixth transfer in glucose-blood culture media, covering periods of nineteen and twenty-one days, respectively.

3. In one series the medium first inoculated was nonvirulent at the end of twelve days, while the fourth transfer from this tube of culture medium after the same period of time was virulent.

4. Results obtained from numerous experiments indicate that fresh blood from nonimmune cattle as a main constituent and glucose as an addition are essential components of the culture media.

REFERENCES

- (1) TARTACOVSKY, M. M. Contribution à l'étiologie de la peste bovine. *Arch. sci. biol.*, St. Petersburg (1896), 4, 295-327.
- (2) NENCKI, M., SIEBER, N., and WIJNIKewITCH, W. Recherches sur la peste bovine. *Ibid.* (1896), 4, 374-396.
- (3) KOCH, R. Reise-Berichte über Rinderpest, etc. Julius Springer, Berlin (1898), 5-33, 56, 65; Report. *Veterinary Journ.* (1897), 45, 204; Berichte des Herrn Prof. Dr. Koch über seine in Kimberley gemachten Versuche bezüglich Bekämpfung der Rinderpest. *Centralbl. f. Bakt. etc.*, 1 Abt. (1897), 21, 526.
- (4) BASS, C. C., and JOHNS, F. M. The cultivation of (*Plasmodium vivax* and *Plasmodium falciparum*) in vitro. *Journ. Exp. Med.* (1912), 16, 567.

AN ATYPICAL CASE OF RINDERPEST IN A CARABAO ¹

By WILLIAM HUTCHINS BOYNTON

(From the *Veterinary Division*,² *Bureau of Agriculture, Manila, P. I.*)

One chart

In studying the subject of rinderpest in the textbooks one is apt to gain the idea that this affection is infallibly an acute, febrile, infective disease. Descriptions usually state that the first symptom noticeable is a rise of temperature, which appears in from three to five days after infection. Some observers have noticed a rise in temperature as early as from thirty-six to forty-eight hours after infection. The symptoms which follow; such as, a seropurulent discharge from the nostrils and eyes, diarrhœa, loss of appetite, emaciation, and general debility, usually appear in from one to four days after the rise of temperature.

The more recent periodical literature contains references to the fact that rinderpest occasionally assumes a mild type, becoming very difficult to recognize.

Littlewood(1) in Egypt has observed that cattle imported from Asia Minor may not show clinical symptoms and yet at autopsy reveal lesions of rinderpest.

Rickmann(2), writing of rinderpest in German Southwest Africa, refers to the fact that cattle and other animals may be infected to an imperceptible degree.

Eggebrecht(3) observed in China, that some animals infected with rinderpest show no visible signs of the disease beyond a rise in temperature to 40° C. or higher for two days.

Baldrey(4), describing conditions in India, states that by long residence of any organism of contagious animal disease in one place the disease becomes weakened in virulence to the animals of that place. Thus, animals infected with rinderpest may act as carriers without showing symptoms.

In the course of work on rinderpest, I encountered a case which yielded some interesting facts regarding mild symptoms and transmissions by both blood injection and by close association.

Carabao 3235, upon which the observations made in this paper are largely based, was received at the veterinary research laboratory at Alabang, Laguna Province, Luzon, for experimental

¹ To be published as Bulletin No. 31 of the Bureau of Agriculture of the Government of the Philippine Islands.

² Archibald R. Ward, chief.

purposes on August 25, 1911, having come from Davao District, Mindanao. It was kept in quarantine with the other experimental animals until inoculated on September 23, 1911. At that time this animal and bull 3205 were each given 10 cubic centimeters of virulent blood from an animal sick with rinderpest.

Nine days after inoculation, 3235 was noticed to have a diarrhœa and the eyes were slightly congested; at ten days the diarrhœa became profuse, seropurulent exudate was discharged from the eyes and nostrils, and the animal ate but little. After eleven days the animal stopped eating and displayed all the external appearances of a severe case of rinderpest, except that the temperature had not at any time gone higher than 38°.9 C. On the twelfth day the temperature dropped to 36°.4 C., which is subnormal, and the animal died during the night of the twelfth day after inoculation. Post-mortem examination revealed large ulcers in the mouth and marked congestion of the peritoneal cavity, fourth stomach, and rectum. The duodenum was also markedly congested, and showed many small ulcers. The cæcum was but slightly congested excepting around the ileocæcal valve. Thus the lesions were regarded as typical of those of rinderpest.

From the temperature chart of 3235 it can be noted that the temperature never rose above normal and was a little lower than that of the average healthy animal. On the fifth and sixth day there was a variation in the temperature which is often seen in rinderpest just before the initial rise. However, the only typical evidence of rinderpest so far as temperature is concerned was the drop to subnormal on the eleventh day, at the time of collapse.

There is no doubt that animal 3235 was suffering from rinderpest, for 3205, which was inoculated with the same blood, experienced a typical attack. The identity of the disease in 3235 is further shown by a series of inoculations of its blood, at various stages of the attack, into other animals. Susceptible animals were inoculated with blood at three, four, five, six, and eleven days after the original inoculation of 3235. Of these, 5 animals contracted typical attacks of rinderpest and 3 died, and post-mortem examination showed typical lesions of rinderpest. No injections were made from the seventh to tenth days after injection because at that time the absence of the febrile temperature in 3235 led to the conclusion that the animal did not have rinderpest. Susceptible animals were exposed in the same pen with 3235 on the eleventh and twelfth days without contracting rinderpest. Another susceptible animal was exposed for twenty-four hours in the same pen in which 3235 had died

the day before, but did not contract rinderpest. The susceptibility of these three animals to rinderpest was proved later by their becoming infected with the disease on exposure in other experiments.

CONCLUSIONS

1. From the facts of this case, the evidence is conclusive that an animal may experience a fatal attack of rinderpest without the occurrence of a rise in temperature.

2. The blood of carabao 3235 was shown to be infected within forty-eight hours after it was originally injected with virulent blood.

3. It was shown that the blood was virulent on the eleventh day when injected into a susceptible animal, yet exposure to the

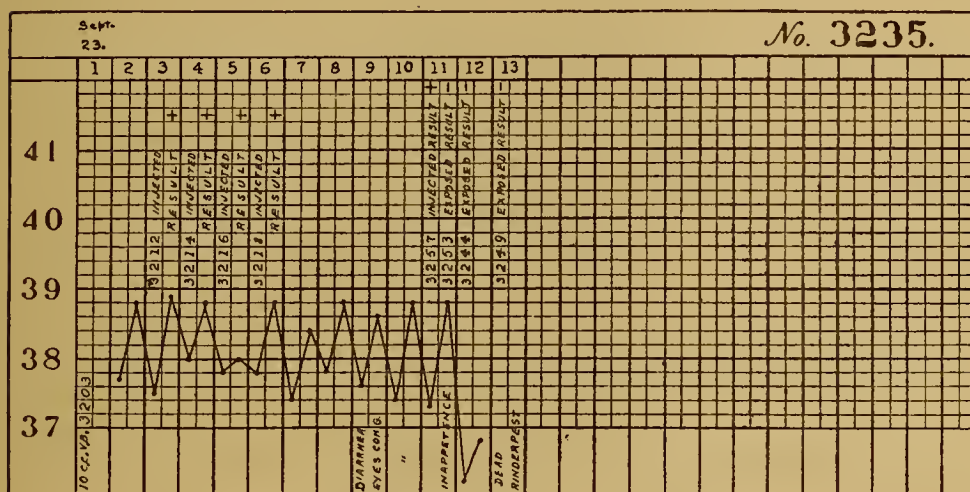

same animal from which blood was drawn did not cause rinderpest in the exposed susceptible animal.

4. With regard to the three animals which failed to contract rinderpest by exposure, the question is raised as to whether rinderpest spreads by contact readily in the later stages of the disease or whether the disease must necessarily be accompanied by a rise of temperature before it can be spread by contact.

REFERENCES

- (1) LITTLEWOOD, W. Cattle plague in Egypt in 1903-04-05. *Journ. Comp. Path. & Therap.* (1905), 18, 312.
- (2) RICKMANN, W. Tierzucht und Tierkrankheiten in Deutsch Suedwest Africa (1908), 156.
- (3) EGGBRECHT, M. Untersuchung über die Rinderpest in Ostasien. *Zeitschr. f. Infektionskrankh. etc.* (1910), 7, 54.
- (4) BALDREY. Climatic influence upon the incidence of disease. *Agr. Journ. India* (1912), 7, pt. III, 294.

EXPERIMENTS UPON THE TRANSMISSION OF RINDERPEST ¹

By ARCHIBALD R. WARD, FREDERICK WILLAN WOOD, and WILLIAM HUTCHINS BOYNTON

(From the *Veterinary Division*,² *Bureau of Agriculture, Manila, P. I.*)

Two plates and six charts

In combating rinderpest, information concerning the length of time the virus remains active outside of the body under various natural conditions is of great importance in suggesting the measures to be employed in the field. Information concerning the period during the course of the disease when the virus is disseminated by sick animals is of equal usefulness.

The literature on the disease consulted by us contains scanty and contradictory reference to these significant topics.

Réfik-Bey and Réfik-Bey(1) state the following:

Infected areas do not remain dangerous for long if we may believe our own observations. We regard rinderpest virus as essentially fragile and incapable of development in external media.

Edington(2) states:

Similarly the nasal mucus from a spontaneous case of rinderpest was found to lose its virulence very quickly if exposed to the air and kept for any period beyond 24 hours.

Stockman,(3) writing about the serum-alone method, observes:

The virulent material does not remain active for more than a day or two outside the animal body.

Yersin(4) states that two days of desiccation are sufficient to destroy the virulence of the blood.

Ruediger(5) states that pastures which have been infected by sick animals may remain infected for months or even for years.

Hutyra and Marek(6) give an extensive symposium of views of various writers.

We have carried out a series of experiments bearing on the subject of the transmission of rinderpest designed to simulate natural conditions as nearly as possible.

¹ To be published as Bulletin No. 30 of the Bureau of Agriculture of the Government of the Philippine Islands.

² Archibald R. Ward, chief.

DURATION OF RINDERPEST INFECTION IN CORRALS AFTER REMOVAL OF INFECTED ANIMALS

Experiment 1.—This experiment was designed to furnish information regarding the length of time that rinderpest infection would remain in a corral subsequent to the removal of infected animals.

The corral had been subjected to infection by the presence of bull 2985, carabao 3008, and carabao 3005, each of which had undergone an attack of rinderpest while kept there. The period during which these animals collectively had displayed febrile temperature, diarrhoea, and other symptoms of rinderpest covered fifteen days previous to their removal. At that time 2985 was in the middle stage of the attack, and had been showing a febrile temperature for five days. Furthermore, the corral had contained other infected cattle and carabaos during the previous three months.

The corral contained a pool directly exposed to the sunlight, which had been used as a wallow by the carabaos mentioned above. There was very little shade, barely enough for the comfort of the animals, and no grass. The infectiveness of the corral immediately after removing all animals was not checked. A photograph of the corral is shown in Plate I, fig. 1. For this experiment, the only water supply available was the above-mentioned pool. No one entered the corral during the experiment excepting after disinfection of the feet. The conditions of the experiment follow:

February 15, 1911. All animals were removed from the corral at 8 a. m. Sky clear and bright.

February 16. At 8 a. m. bull 3052 was turned loose in the corral and left for a period of twenty-four hours. It was seen to drink from the carabao wallow. Sky clear and bright.

February 17. At 8 a. m. bull 3052 was removed from the corral, disinfected, and segregated along with a susceptible control animal to check against accidental infection subsequent to that in the corral. Sky clear and bright.

February 18. Corral empty. Sky partly cloudy.

February 19. Bull 3055 was turned into the corral, and was seen to drink from the wallow. Sky partly cloudy, high wind.

February 20. Bull 3055 was removed from corral, disinfected, and segregated with one control. Sky clear and bright.

February 21. Corral empty. Sky partly cloudy.

February 22. Bulls 3058 and 3059 were put in the corral, and drank from the wallow. Sky clear and bright.

February 23. Bull 3058 was removed from corral, disinfected, and segregated with a control. Sky clear and bright.

February 24. Bull 3059 still in corral. Sky clear and bright.

February 25. Bull 3059 was removed from corral, disinfected, and segregated with a control. Sky partly cloudy.

February 26. Corral empty. Sky cloudy and weather cool.

February 27. Corral empty. Sky partly cloudy. Slight showers during night and early morning.

February 28. Corral empty. Sky clear and very hot weather.

March 1. Wallow was reflooded with water to replace loss from leakage and evaporation. Two native carabaos, 3078 and 3079, were placed in the corral; they were seen to drink from the wallow. Sky clear and bright.

March 2. Carabaos still in the corral. Sky partly cloudy.

March 3. Carabaos still in corral. Sky clear and bright.

March 4. Carabaos still in corral. Rain during forenoon, clear in afternoon.

March 5. Carabaos 3078 and 3079 were removed from corral, disinfected, and segregated with a control. Sky clear and bright.

None of the animals exposed in the corral in this experiment contracted rinderpest. The susceptibility of 3052, 3078, and 3079 was proved subsequently by their contracting rinderpest after suitable exposure. Bull 3059 did not react. Record of 3055 is not complete in this respect.

The main details of the experiment are summarized in Table I.

TABLE I.—*Exposure of susceptible animals to supposedly infected corral.*

Animal No.	Interval between removal of sick and exposure of susceptible animal.	Time of exposure in corral.	Result.	Susceptibility test later.
	<i>Days.</i>	<i>Days.</i>		
3052.....	1	1	Negative	Susceptible.
3055.....	4	1	do	Not tested.
3058.....	7	1	do	Susceptible.
3059.....	7	3	do	Immune.
3078.....	14	4	do	Susceptible.
3079.....	14	4	do	Do.

Subsequent experiments have shown the peculiarities of the disease to be such that of the three animals last in the corral, 2985 only was probably disseminating infection on February 15. This fact does not invalidate the experiment in demonstrating the noninfectiveness of the corral after it had been occupied for several previous months by infected animals.

Experiment 2.—This experiment was designed to check the results of the previous experiment under slightly different conditions. The corral employed, designated No. 2, was well shaded by a tree, and contained a watering trough, but no pool. Infected animals had occupied this corral for nineteen days before the beginning of the experiment. A photograph of this corral is shown in Plate I, fig. 2.

The cattle in the corral on March 7, 1911, were 3062, seventh day after inoculation and showing fever and inappetence; 3057, fourteenth day after inoculation, died same day; 3042, twenty-seventh day after exposure and well; 3043, twenty-eighth day after exposure; 3045, forty-first day after exposure and well; and 3048, thirtieth day after exposure, but still sick.

Of these six, it is most likely that animals 3048, at the fifth day of febrile temperature; 3057, at the sixth day; and 3062, at the fifth day only were disseminating infection at the date they were removed from the corral, a fact unsuspected at the time the experiment was performed. All had occupied the corral for periods ranging from two to six days. The details concerning the exposure of the animals in the corral appear below.

March 6, 1911. The following animals were removed on this day: 3062, 3057, 3042, 3043, 3045, and 3048. Sky clear and bright.

March 7. Bull 2999 was placed in the corral. Sky clear and bright.

March 8. Bull 2999 was removed from the corral, disinfected, and segregated with a control. Sky clear and bright.

March 9. Corral empty. Sky clear and bright.

March 10. Bull 3000 was placed in the corral. Sky partly cloudy.

March 11. Bull 3000 was removed, disinfected, and segregated with a control. Sky cloudy with slight shower.

March 12. Corral empty. Sky clear and bright.

March 13. Bull 3001 was placed in corral.

March 14. Bull 3001 was removed from corral, disinfected, and segregated with a control. Sky clear and bright.

March 15. Corral was empty. Sky clear and bright.

March 16. Corral was empty. Sky clear and bright.

March 17. Bull 3063 was placed in the corral. Sky clear and bright.

March 18. Bull 3063 is still in corral. Sky partly cloudy.

March 19. Bull 3063 was removed from the corral, disinfected, and segregated with a control. Sky cloudy with some rain.

None of the cattle exposed in the corral in this experiment contracted rinderpest. All were subsequently shown to be susceptible to rinderpest by contracting the disease after suitable exposure.

The main details in the foregoing are summarized in Table II.

TABLE II.—*Exposure of susceptible cattle to supposedly infected corral.*

Animal No.	Interval between removal of sick and exposure of susceptible animal.	Time of exposure in corral.	Result.	Susceptibility test later.
	<i>Days.</i>	<i>Days.</i>		
2999.....	1	1	Negative	Susceptible.
3000.....	4	1do.....	Do.
3001.....	7	1do.....	Do.
3063.....	11	2do.....	Do.

Like the preceding one, this experiment did not demonstrate that infection of rinderpest could persist in the corral for even one day after the removal of the sick.

Experiment 3.—This experiment was designed to duplicate the conditions of the preceding experiments with presumably infected corrals, but under different weather conditions, as cloudy rainy weather existed during the progress of this experiment. The same corral was used as in the preceding one.

The corral had been subjected to infection by bulls 3064, 3066, and 2998. On the day that they were removed the disease had progressed among them as follows: 3064, third day of febrile temperature; 3066, third day; and 2998, sixth day. The exposure of the various animals is described in the following notes:

July 22, 1911. Bulls 2998, 3064, and 3066, all infected with rinderpest, were removed from the corral at 4 p. m. Weather rainy and corral very muddy.

July 23. Two susceptible cattle, 3147 and 3151, were turned loose in the corral at 4 p. m. Weather rainy.

July 24. Two susceptible carabaos, 3164 and 3178, were turned loose in the corral at 4 p. m. The cattle mentioned in the preceding paragraph remained in the corral. Weather rainy.

July 25. The 2 cattle and 2 carabaos still in the corral. Sky cloudy and showers.

July 26. Animals still in the corral. Sky cloudy and showers.

July 27. All of the susceptible animals were removed from the corral on this date and segregated. Sky cloudy and showers.

None of the animals used in this experiment contracted rinderpest. All of them were later shown to be susceptible with the exception of 3151, which died as a result of exposure to bad weather.

The main details of the experiment are summarized in Table III.

TABLE III.—*Exposure of susceptible animals to supposedly infected corral.*

Animal No.	Interval between removal of sick and exposure of susceptible animal.	Time of exposure in corral.	Result.	Susceptibility test later.
	<i>Days.</i>	<i>Days.</i>		
3147.....	1	4	Negative ..	Susceptible.
3151.....	1	4do	Not tested.
3164.....	2	3do	Susceptible.
3178.....	2	3do	Do.

The chief distinction between this experiment and those preceding lies in the rainy weather prevailing and the resulting muddy condition of the corral. The results coincide with those of the former experiments in that infection was not demonstrated to persist in the corral for one day.

Experiment 4.—This experiment was essentially a duplication of experiment 1, except that the carabao wallow was covered on top and on three sides with a bamboo and grass roof.

The corral had been infected by the presence of carabaos 3085 and 3086, both in a stage of the disease corresponding to the sixth day following the initial rise of temperature. During the last twenty-four hours that these animals were in the corral, bull 2999 was kept with them as a control to show the existence of infection. The animal was removed, isolated, and developed rinderpest. During the day previous to removal, the sick carabaos occupied the wallow and defecated therein. The details regarding the exposure of the animals in the corral appear in the notes below.

April 2, 1911. Bulls 3085, 3086, and 2999 were removed from the corral.

April 3. Bull 3104 was turned loose in the corral; it was seen to drink from the wallow. Sky clear and air dry.

April 4. Bull 3104 was still in corral. Sky clear and air dry.

April 5. Bull 3104 was removed from corral, disinfected, and segregated with controls against accidental infection. Carabao 3079 was put in the wallow on this date, being led through the corral with pads on his feet soaked in disinfectant. Rain occurred during the night.

April 6. Carabao 3079 was removed from corral, and immediately disinfected and segregated with control. Rain occurred during the morning.

April 7. Carabao 3090 was put in wallow in the corral with the same precautions as taken with carabao 3079. Sky clear and bright.

April 8. Carabao 3090 was removed from corral, disinfected, and isolated with control. Sky clear and air dry.

April 9. Carabao 3087 was turned loose in the corral, and was left in corral one week. Sky clear and air dry.

None of the animals contracted rinderpest; the susceptibility of all was proved subsequently.

The chief features of the foregoing experiment are summarized in Table IV.

TABLE IV.—*Exposure of susceptible carabaos in supposedly infected corral.*

Animal No.	Interval between removal of sick and exposure of susceptible animal.	Time of exposure in corral.	Result.	Susceptibility test later.
	<i>Days.</i>	<i>Days.</i>		
3104.....	1	2	Negative	Susceptible.
3079.....	3	1do.....	Do.
3090.....	5	1do.....	Do.
3087.....	7	7do.....	Do.

The infectivity of the corral was tested, after intervals of from one to seven days after the removal of the sick, by animals kept therein for intervals of from one to seven days, with negative results.

Experiment 5.—This experiment was planned to determine the duration of infectivity of virus in a corral during hot dry weather. Corral 3 was used for the purpose, and had been supposedly infected by the presence of infected bulls 3330 and 3329. On the day that they were removed, the disease had progressed in 3330 to a state corresponding to the twelfth day after inoculation and eighth day after initial rise of temperature. The animal at that time showed a temperature of 40°.4 C. with diarrhœa and inappetence. With animal 3329, the day corresponded to the twentieth after inoculation and seventeenth succeeding the initial rise of temperature. At the time, the most severe stage of the disease had been passed ten days before. The period of exposure of the various animals in the corral is shown in the following notes.

March 12, 1912. Bulls 3329 and 3330 were removed from the corral at 1 p. m. The drinking water to which they had had access was not changed. Further, they had intentionally been provided with an excess of Guinea grass, thrown on the ground in the corral so that it might become infected. This fodder was left undisturbed for the successors of the sick animals. The sky on this day was clear, and the weather hot and windy.

March 13. At 1 p. m. bull 3341 was placed in the corral after having been deprived of food and water during the forenoon. The animal immediately began to eat the soiled fodder, and drank from the pail of water to which the sick animals had had access. The weather continued dry, clear, hot, and windy.

March 14. At 1 p. m. bull 3339 which also had been deprived of food and water was placed in the corral. It immediately began to drink from the fresh supply of water provided in the same pail as used by the sick, and ate fresh fodder that had been scattered over the ground. The weather continued unchanged.

March 15. At 1 p. m. bull 3343 was placed in the corral after having been deprived of food and water during the forenoon. The animal immediately began to eat fodder from the ground. Weather unchanged.

March 16. Weather unchanged.

March 17. At 1 p. m. bulls 3341, 3339, and 3343 were removed from the corral and placed in stalls isolated from infection. Weather conditions remained unchanged.

None of the animals developed rinderpest as a result of exposure in this corral, but all were subsequently proved to be susceptible.

The principal details of the experiment appear in Table V.

TABLE V.—*Exposure of susceptible animals to supposedly infected corral.*

Animal No.	Interval between removal of sick and exposure of susceptible animal.	Time of exposure in corral.	Result.	Susceptibility test later.
	<i>Days.</i>	<i>Days.</i>		
3341.....	1	4	Negative	Susceptible.
3339.....	2	3do.....	Do.
3343.....	3	2do.....	Do.

As usual the experiment furnished no evidence of the persistence of infection in the corral even for twenty-four hours.

Experiment 6.—This experiment, with the exception of a slight variation in the weather conditions, is a duplication of the previous one, the same corral, No. 3, being used. Four bulls had been employed to infect the corral. At the time of removal, the disease in 3338 had reached the twelfth day after inoculation, seventh after initial temperature; 3335, sixteenth day after inoculation and tenth after initial rise; 3336, thirteenth day after inoculation and eighth after initial rise. These had been kept in the corral during the earlier stages of the attack, but 3330 was left there for only three days. When removed, the progress of the disease in this animal corresponded to the twentieth day after inoculation and sixteenth after initial rise of temperature. The details regarding periods of exposure in the corral appear in the notes below.

March 20, 1912. At 2 p. m. the 4 sick animals were removed. The weather was cloudy, windy, and slightly cool.

March 21. Bull 3342 was placed in the corral after having been deprived of food and water during the forenoon. It immediately began to eat soiled fodder left by the sick, and drank from the supposedly contaminated watering trough.

March 22. Showers occurred during the forenoon and afternoon. The weather was hot and windy. Bull 3344 was placed in the corral at 2 p. m., hungry and thirsty.

March 23. Bull 3361 was placed in the corral at 2 p. m., and immediately began eating and drinking as had the others. On this day the sky was clouded.

March 28. Bulls 3342, 3344, and 3361 were removed on this date and placed in stalls isolated from infection.

None of the cattle contracted rinderpest from exposure in the corral, but their susceptibility was proved by attack after suitable exposure at a later period. The chief details of the experiment appear in Table VI.

TABLE VI.—*Exposure of susceptible cattle to supposedly infected corral.*

Animal No.	Interval between removal of sick and exposure of susceptible animal.	Time of exposure in corral.	Result.	Susceptibility test later.
	<i>Days.</i>	<i>Days.</i>		
3342.....	1	7	Negative ...	Susceptible.
3344.....	2	6	...do ...	Do.
3361.....	3	6	...do ...	Do.

As usual, no evidence was produced to show that the sick animals left the corral infective for even a day.

Experiment 7.—This experiment was essentially a duplication of the two preceding ones except that the ground in the corral was kept moist by sprinkling, in order to simulate conditions caused by wet weather. The same corral was employed as before. Three bulls, all infected with rinderpest, had been kept in the corral. On the day that they were removed, the disease in bull 3122 had reached a stage corresponding to the eleventh day after inoculation and eighth after initial rise of temperature; in 3366, the twelfth after inoculation and seventh after temperature rise. Bull 3300 died the day before, which was the ninth day after inoculation and fifth after rise of temperature. This one had been in the corral two days; 3122, seven days; and 3366, eleven days, since inoculation.

While the animals were in the corral, the ground was kept wet by sprinkling. The exposure of the animals in the corral is described in the following notes:

April 25, 1912. Sick animals were removed from the corral.

April 26. At 7.30 a. m. bull 3373 was placed in the corral. It immediately began to eat the contaminated fodder that had been kept wet, and drank from the trough. At 7.30 p. m. bull 3374 was placed in the corral. The sky was clear, and the weather dry and windy. The ground was frequently sprinkled.

April 27. At 7 a. m. bull 3375 was placed in the corral hungry and thirsty. The weather was hot and windy, but the ground was kept moist.

April 28. The weather remained unchanged, and the corral was kept moist.

April 29. There was a shower before sunrise, but otherwise conditions were the same as before.

April 30. The 3 animals were removed from the corral and placed in stalls isolated from infection.

None of the animals contracted rinderpest from exposure in the corral, and all were subsequently proved to be susceptible by contracting the disease after suitable exposure. The principal details of the experiment are shown in Table VII.

TABLE VII.—*Exposure of susceptible cattle to supposedly infected corral.*

Animal No.	Interval between removal of sick and exposure of susceptible animal.	Time of exposure in corral.	Result.	Susceptibility test later.
	<i>Days.</i>	<i>Days.</i>		
3373.....	1.0	4.0	Negative ...	Susceptible.
3374.....	1.5	3.5	...do ...	Do.
3375.....	2.0	3.0	...do ...	Do.

No evidence was produced to show that the sick animals left the corral infective for even one day.

Experiment 8.—This experiment was similar in purpose to the preceding ones, and the same corral, No. 3, was used. Three bulls had been employed for infecting the corral. When they were removed, the disease in 3348 had progressed ten days from inoculation and six days from rise of temperature; in 3391, thirteen and eight days, respectively; and in 3303, seven and five days, respectively. The first mentioned had been in the corral seven days; the second, eight days; and the last, five days

when they were taken out. The details of exposure in the corral are described in the following notes:

July 1, 1912. At 5 p. m. the sick animals were removed from the corral, and bull 3298 was put in the corral at 5 p. m.

July 2. At 5 a. m. bull 3298 was removed and isolated. Bull 3402 was placed in the corral at the same time.

July 3. Bull 3403 was placed in the corral at 5 a. m.

July 4. All animals were removed at 5 a. m. and placed in screened stalls isolated from infection.

Bull 3298, which was used as a control to demonstrate the existence of infection in the corral just after the removal of the sick, showed a rise of temperature on the sixth day, and died on the twelfth day after exposure. None of the others, exposed later, contracted the disease, but their susceptibility was proved subsequently. The principal details of the experiment are shown in Table VIII.

TABLE VIII.—*Exposure of susceptible animals in infected corral.*

Animal No.	Interval between removal of sick and exposure of susceptible animal.	Time of exposure in corral.	Result.	Susceptibility test later.
	<i>Hours.</i>	<i>Hours.</i>		
3298.....	None.	12	Positive ----	
3402.....	36	48	Negative ----	Susceptible.
3403.....	48	24	----do ----	Do.

No evidence was produced to show that the corral remained infective for over twelve hours after the sick were removed. The experiment in question was stronger than the preceding in that the existence of infection left by the sick was demonstrated.

Experiment 9.—This experiment was similar in character to the last, and the same corral was used. Bull 3389 was used to infect the corral, where it remained during the course of the disease. The initial rise of temperature occurred on the fourth day after inoculation and death on the seventh day. The periods of exposure in the corral are shown in the following notes:

June 27, 1912. Bull 3389 died and was removed at 8 a. m. The weather was rainy and hot. Corral was left empty until the next day.

June 28. Bull 3395 was placed in the corral at 8 a. m.

June 29. Bull 3395 was removed from the corral at 8 a. m. and isolated in a screened shed.

Bull 3395, which remained in the corral for twenty-four hours after the corral had stood empty an equal period of time, did not contract the disease. It was later proved to be susceptible.

As in previous experiments, no evidence was produced to show that rinderpest infection will persist in a corral for twenty-four hours.

Experiment 10.—In view of the fact that failure had attended all attempts in the previous experiments to infect animals after an infected corral had been vacated for twenty-four hours, this experiment was performed to make tests at shorter intervals. The same corral was used as in the previous experiment. It was infected by the presence of carabao 3173, at a stage of the disease corresponding to the third day of febrile temperature; 3172, fifth day; 3171, fifth day; 3160, fourth day; 3074, twenty-third day; 3100, fifth day; 3089, fourth day of febrile temperature. All had occupied the corral for periods varying from one to eight days. The movements of animals into and out of the corral are shown in the notes below:

May 25, 1911. All infected animals were removed from the corral at 4 p. m. The weather was dry and hot. At 4.30 p. m. bull 3073 was turned loose in this corral.

May 26. Bull 3069 was put in the corral at 9 a. m. At 4 p. m. 2 carabaos, 3174 and 3175, were turned loose in the corral. The weather was dry and hot.

May 27. Animals still in corral. The weather was hot in the morning; there were showers in the afternoon.

May 28. Animals still in corral. The weather was hot and dry.

May 29. Animals still in corral. The weather was hot and dry with showers during the night.

May 30. Animals still in corral. The weather was hot with a short shower just at noon.

May 31. Animals still in corral. The weather was hot with showers during afternoon and evening.

June 1. Animals were removed from the corral and placed in screened stalls, separated one from the other. No attendants entered the corral after the original infected animals were removed on May 25, and temperatures were not taken during this time.

Bull 3073, exposed for a half-hour interval, and bull 3069, exposed for seventeen and one-half hours, developed rinderpest on the same date, showing that the corral was infective at least seventeen and one-half hours after the removal of the sick animals. The two carabaos, 3174 and 3175, which were put in the corral after an interval of twenty-four hours, failed to develop rinderpest. Both of these carabaos contracted rinderpest in subsequent experiments.

Details of the experiment appear in Table IX.

TABLE IX.—Exposure of susceptible animals in infected corral.

Animal No.	Interval between removal of sick and exposure of susceptible animal.	Time of exposure in corral.		Result.	Susceptibility test later.
		Hours.	Days.		
3073.....	0.5		7.0	Positive ----	
3069.....	17.5		6.0	} ----do ----	
			6.5		
3174.....	24.0		6.0	Negative ----	Susceptible
3175.....	24.0		6.0	----do ----	Do.

^a Hours.

The results of this experiment tend to confirm those previously obtained. They lend color to the belief that in former experiments in this corral the infection had really perished and that the failure of animals to become infected was not due to mere accidental avoidance of infected spots.

The series of experiments demonstrated the necessity of attacking the problem from a different angle, as described in the following experiments.

PERIOD OF INFECTIVENESS DURING ATTACK

Experiment 11.—This experiment was designed to furnish information regarding the relation between the period of infectiveness and the stage of the disease in cattle. It was not so arranged as to permit of discrimination between infection obtained directly from the sick animal on a given day and that which might be obtained from virus several days old that had resisted natural disinfecting agencies. This latter possibility seemed improbable in view of the results obtained in the foregoing experiments.

Two bulls, 3001 and 3060, were injected with virulent rinderpest blood on April 14, 1911. These were placed in a small corral, 7.2 by 5.3 meters, and consequently it was possible to determine only facts concerning the joint infectiveness of the two. The corral was well shaded and usually in a muddy condition. Opportunity for the transmission of infection by close crowding and the use of the same drinking-water bucket and feeding trough were encouraged. The animals habitually placed their feet in the feed box. A photograph of this corral is shown in Plate II. The other susceptible cattle were placed in immediate contact with them in turn for a period of twenty-four

hours each, after which they were removed and isolated. Immediately after removing these exposed animals, they were thoroughly disinfected outside of the corral. All of the cattle exposed to infection were afterward isolated with precautions to prevent accidental exposure from other sources.

The details of the experiment appear in the double temperature chart of animals 3001 and 3060. The plus and minus signs indicate whether or not the animals subjected to infection by exposure or inoculation developed rinderpest when afterward isolated. All of these animals that developed rinderpest showed the initial symptoms at the usual and expected interval corresponding to the date of exposure. All of the animals that gave negative results upon exposure subsequently contracted rinderpest in other experiments, except 3102, which did not react to

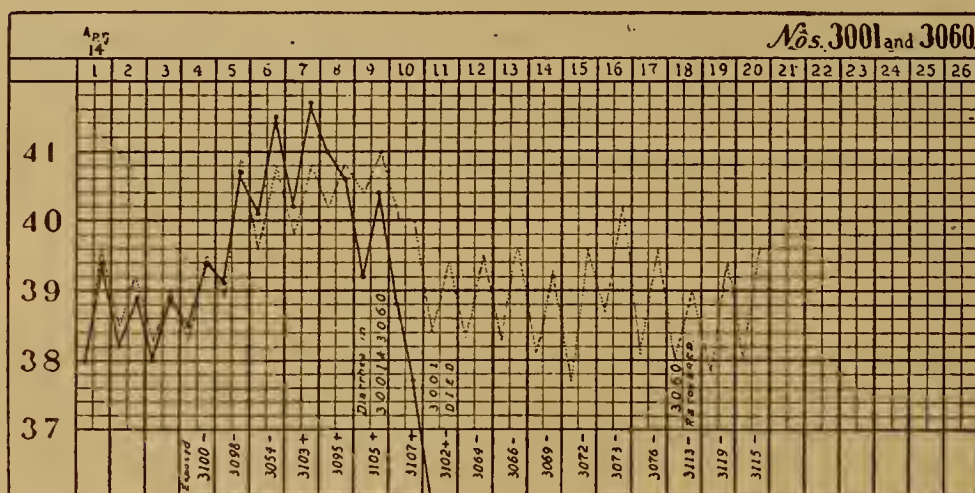

the supposedly active virus administered. Plus and minus signs indicate the inconclusive nature of the test on the eleventh day.

Reference to the chart will show that an animal exposed to the original infected animals on the fourth day of the experiment, which was the day preceding the rise of temperature, did not become infected. No infection resulted on the following day—that of the first rise of temperature. From the sixth to the tenth days, inclusive, exposure in the corral, with the two original animals, resulted in the infection of the exposed. From the eleventh to the twentieth days, inclusive, when the experiment closed, exposure did not induce infection. Data on the eleventh day are inconclusive. One of the original animals died on the eleventh day. In the case of the animal that recovered, diarrhoea persisted for eight days after the last case of infection

from the corral. The animals were infective during three days of the febrile period, and only so during two or possibly three days of the period when symptoms were marked. Thus, these two animals were infective during only two or three days of the period when the disease could have been recognized by inspectors in the field.

It should be noted that irrespective of the presence or absence of infection from 3060, no infective material, deposited in the previous days, remained active after the eleventh day. This confirms the observations in the three preceding experiments, and is more important because in this small crowded corral there was no possibility of escaping infection as animals might in a larger one.

Experiment 12.—The purpose of this experiment was to deter-

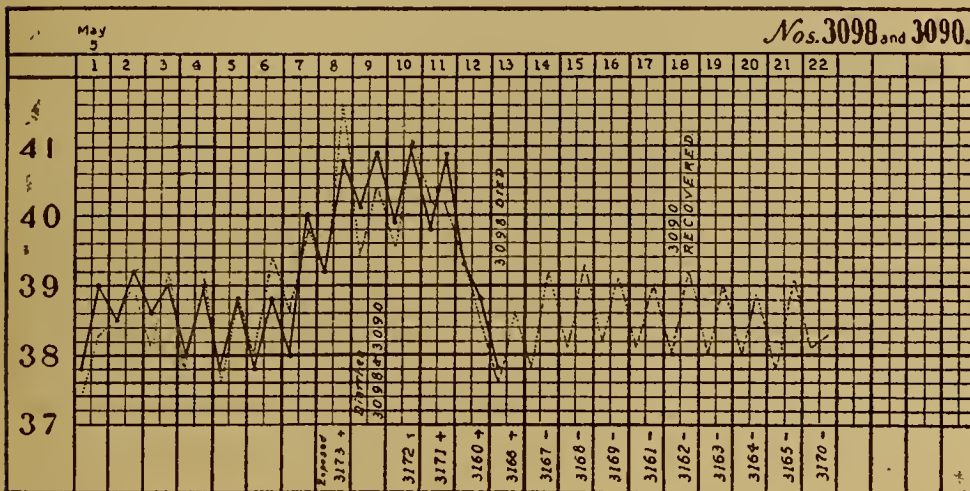

mine the period during which a carabao and a bull in a corral together would be infective to carabaos by natural exposure. It was a duplication of experiment 11, except as to the kind of animals employed.

Bull 3098 and carabao 3090 were exposed to natural infection, and were placed in the same corral as used in experiment 4. Beginning with the eighth day after the original animals had contracted the disease up to the twenty-second day, excepting only the ninth, susceptible carabaos were exposed for twenty-four hours each in the corral with the carabao and bull. After exposure the carabaos were disinfected outside of the corral and isolated. The susceptibility of the animals that gave negative results upon exposure was proved in subsequent experiments. Further details appear in the double temperature chart of animals 3098 and 3090.

As in experiment 11, the infective period by natural exposure was shown to be short, and corresponded closely to the febrile period. Further, the infection did not remain active in the corral after the sick animal had passed the infective stage.

Experiment 13.—This experiment was similar in purpose and technique to experiments 11 and 12, except that carabaos were used exclusively. Carabao 3170 was injected with virulent blood on June 9, 1911, and placed in the usual corral. Susceptible carabaos were exposed for twenty-four hours each at ten, eleven, fourteen, and fifteen days after inoculation, and were isolated as usual. The susceptibility of 3177 was demonstrated later. Further details appear in the following temperature chart:

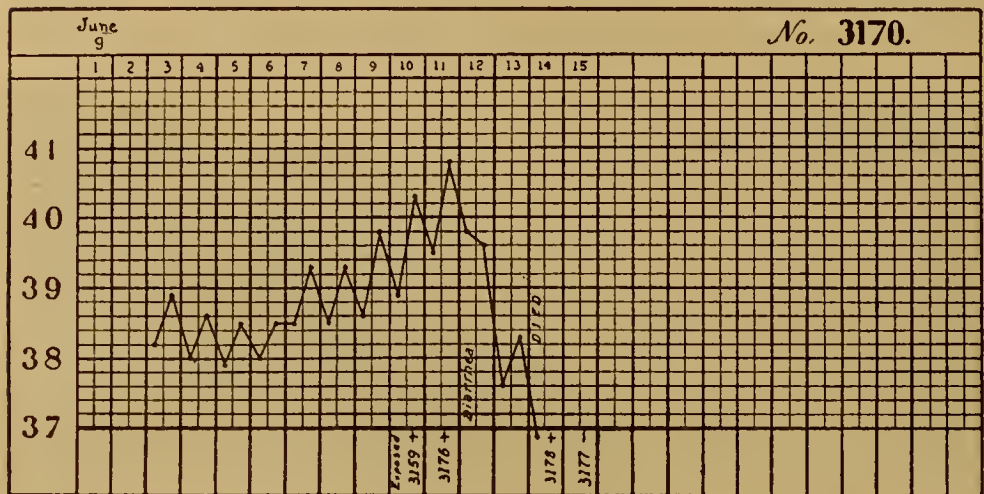

Reference to the chart will show that the animal was infective for at least two days preceding the appearance of diagnostic symptoms. The experiment also confirms the belief that the infective period is short and that infectious material does not remain active in the corral.

INFECTIVENESS OF BLOOD DURING DISEASE

Experiment 14.—This experiment was planned to give information regarding the presence of rinderpest virus in the blood at various stages of the disease. Bull 3000 was infected by injection with virulent blood on April 11, 1911. Blood was drawn during the disease at various periods corresponding to five, seven, nine, eleven, thirteen, fifteen, seventeen, nineteen, and twenty-one days after the inoculation of the animal and injected into susceptible cattle. These were properly isolated from infection. The work is shown graphically in the temper-

ature chart of bull 3000. Plus or minus signs indicate whether or not the animals injected with blood did or did not develop rinderpest in isolation.

The blood of 3000 was not infective on the fifth day, but was infective on the seventh, ninth, and eleventh days. On the thirteenth, fifteenth, seventeenth, nineteenth, and twenty-first days no infection resulted from the injection of blood from this animal.

The susceptibility of the animals giving negative results in this experiment has been shown by their contracting rinderpest in subsequent experiments.

A consideration of the results obtained from this animal, together with those of experiment 11, would lead to the conclusion that the blood is infective early in the disease, before

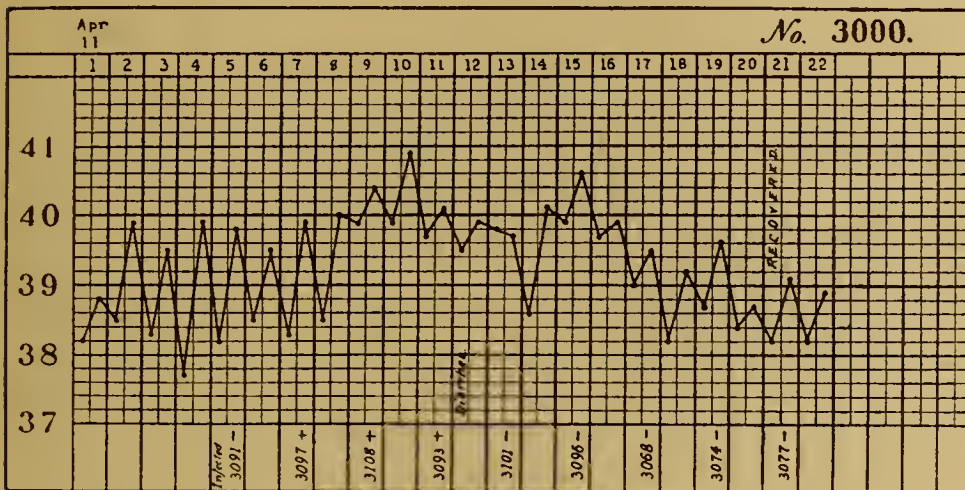

the animal is capable of transmitting the disease by natural exposure.

Experiment 15.—This experiment was similar in purpose to the preceding one. Blood from bull 3063 was injected into susceptible cattle at six, eight, ten, twelve, fourteen, and sixteen days after the bull had been injected on April 1, 1911. The details of the experiment are presented in graphic form in the temperature chart.

The blood was infective on the sixth day of the experiment, which was the third day before a rise of temperature. It was likewise infective in the eighth, tenth, twelfth, fourteenth, and sixteenth days when the animal died.

Observations regarding the infectiveness of blood in the later stages of the disease of the two animals in this and the preceding

experiment are not in agreement. It has been observed³ that blood drawn in the later stages of rinderpest did not transmit the disease.

INFECTIVITY OF GRASS AFTER SPRINKLING WITH URINE FROM INFECTED ANIMALS

Experiment 16.—This experiment differed from the preceding ones in that urine diluted with an equal amount of water was sprinkled on grass and animals were allowed to graze after various intervals.

Five hundred cubic centimeters of urine were collected on April 11, 1912, from bull 3361. At 4.30 p. m. on the twelfth day after injection with virulent blood and the seventh day after initial rise of temperature, the diluted mixture was sprinkled

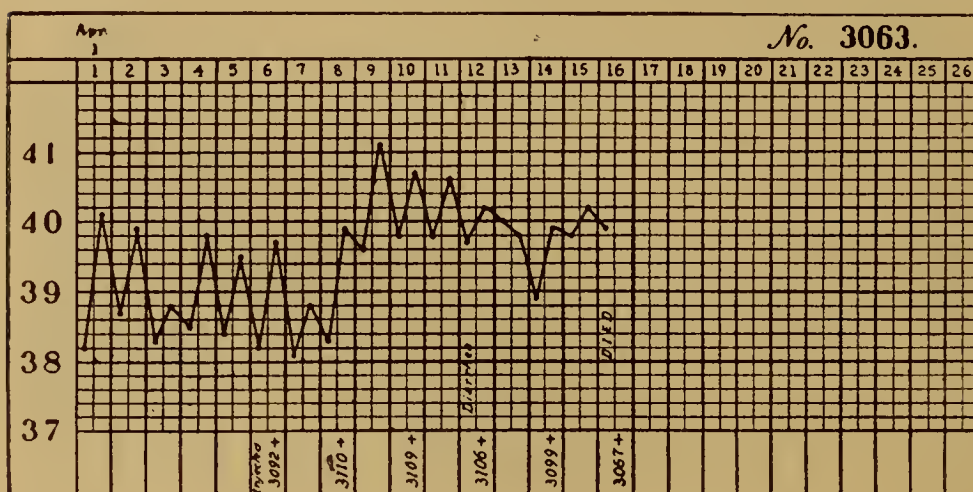

on the grass plot, which was left unoccupied for twenty-four hours, the weather being dry and hot.

On account of the expense involved, no control was used to demonstrate the infectiveness of the urine at the time that it was sprinkled on the grass.

On April 12 at the same hour, bull 3365 was picketed over the infected spot and left there twelve hours to graze, after which it was placed in a stall. No rise of temperature was observed after exposure; the susceptibility of the animal was proved subsequently.

In view of the absence of a control, the conclusion must be of a conditional character. It can only be stated that urine, voided at the stage of the disease indicated and left on grass for

³ Ward and Wood, *Bull. P. I. Bur. Agr.* (1912), No. 19, 59.

twenty-four hours, did not convey infection to a susceptible animal.

Experiment 17.—This experiment continued the investigation of the results following the sprinkling of grass with the urine from an infected animal. A grass plot was used similar to that in experiment 16, and three susceptible cattle were employed.

Urine was collected from two animals. Bull 3361, of the previous experiment, furnished part, collected on the thirteenth day after inoculation and eighth day of febrile temperature; and part came from bull 3199 on the eighth day after inoculation and fourth day after initial rise of temperature.

The urine of both, amounting to 1,000 cubic centimeters, was mixed and diluted to 2,000 cubic centimeters in water. The grass plot was sprinkled with this mixture on April 12, 1912, at 5 p. m., and was left unoccupied for thirty-six hours. The weather on April 13 was cool, with showers in the forenoon, and was clear and hot in the afternoon.

On April 14, at 5 p. m., bull 3366 was picketed over the grass plot and left there to graze until 2.30 p. m., after which it was placed in a screened stall.

During the forenoon the weather was cool, with showers. Bull 3366 showed a rise of temperature on April 19, with diarrhoea on April 23 and inappetence on April 25, followed by recovery.

It is concluded that rinderpest virus remained virulent on the grass for at least thirty-six hours.

Experiment 18.—This experiment was similar to the two preceding ones.

On the sixth day after inoculation, corresponding to the third day of febrile temperature, 500 cubic centimeters of urine were collected from bull 3363 and diluted to 1,000 cubic centimeters with water. At 4.30 p. m., on April 16, 1912, this mixture was sprinkled over grass and the plot was left unoccupied for forty-eight hours. The weather during this interval was dry, hot, and windy. No control was employed to test the infectiveness of the urine at the time that it was sprinkled on the grass.

On April 18, at 4.30 p. m., bull 3372 was picketed on the grass and left there fourteen hours to graze, after which it was placed in a screened stall. No rise of temperature occurred, but the susceptibility of the animal was demonstrated later.

The urine of bull 3363 was tested with negative results on the seventh and eleventh days after inoculation in exactly the

same manner, except that the urine was exposed on grass only twenty-four hours. The temperature of 3363 on each of these dates was above 40° C. During both of these twenty-four-hour periods the weather was dry, hot, and windy, with cloudless sky. Both of the animals exposed to the grass plots failed to contract rinderpest, but their susceptibility was proved later.

It is concluded that if the urine of bull 3363 was virulent when drawn, it was incapable of infecting a susceptible animal after exposure on grass for forty-eight hours in one case and for twenty-four hours in two instances.

Experiment 19.—The purpose of this was similar to that of those experiments immediately preceding. The urine was voided by bulls 3368 and 3371.

Urine from bull 3368 was collected on the sixth day after inoculation—third day of fever—and from bull 3371 at the same stage of the attack. The total amounted to 450 cubic centimeters, was diluted with water to 1,000 cubic centimeters, and sprinkled on the grass on May 8, 1912, at 4.45 p. m.

The plot was left twenty-four hours, after which bull 3373 was picketed on the ground for fourteen hours. No check was used for infectivity of the urine at the time of voiding. Bull 3373 did not become infected; its susceptibility was demonstrated later.

The urine of bull 3368 was tested on the seventh day after injection with negative results; the susceptibility of the exposed animal was demonstrated later.

The mixed urine of bulls 2368 and 3371, if infective at all, did not remain so after twenty-four hours' exposure on grass.

Experiment 20.—The purpose of this experiment was identical with that of the preceding.

Urine from bull 3389 was collected on the fifth day after inoculation, second day of febrile temperature, in the amount of 500 cubic centimeters, and diluted with water to 1,500 cubic centimeters. The mixture was sprinkled on the grass at 4.45 p. m. on June 25, 1912. The plot was left unoccupied for thirty-six hours, the weather during this time being cloudy with showers.

On June 27, at 4.45 a. m., bull 3394 was picketed on the plot and left for twelve hours, after which it was placed in a screened stall. The animal displayed a rise of temperature on July 2 and diarrhoea with inappetence on July 5. Death occurred on July 9.

It is concluded that the urine remained infective when spread on grass for thirty-six hours.

Experiment 21.—The purpose of this experiment was similar to that of the ones immediately preceding. The urine was voided by bull 3374.

Urine to the amount of 150 cubic centimeters was collected on the eighth day after inoculation, second day of febrile temperature. This was diluted to 1,000 cubic centimeters, and was sprinkled on the grass at 4.45 p. m. on June 18, 1912. The plot was left unoccupied for thirty-six hours, and no control was used for infectiveness.

At the expiration of this period, bull 3392 was placed on the grass for twelve hours and did not contract the disease. The susceptibility of this animal was proved later.

It is concluded that, if the urine was infective on the date collected, it did not remain so under the conditions afforded on the grass.

INFECTIVENESS OF URINE AND FÆCES SPRINKLED ON GRASS

Experiment 22.—This experiment differed slightly from the preceding, in that fæces diluted with water were also sprinkled on the grass. The urine and fæces were obtained from bull 3391 on June 26, 1912, which was the eighth day after inoculation and third day of febrile temperature. Two hundred cubic centimeters were diluted with water to 1,000 cubic centimeters and sprinkled upon the grass at 5 p. m. The plot was left unoccupied for forty-eight hours, and no control was used to test the infectiveness of the excreta at the time when voided.

After forty-eight hours bull 3396 was picketed on the spot for twelve hours, but did not contract the disease. Susceptibility of this animal was proved subsequently.

On the twelfth day after inoculation, 500 cubic centimeters of fæces were diluted with water to 1,000 cubic centimeters and sprinkled on the grass. After twenty-four hours, during which time the weather was cloudy, bull 3400 was picketed on the spot; it failed to contract the disease. Very likely the excreta when voided were noninfective, due to the late stage of the disease.

It is concluded that, if the fæces and urine were infective at the time voided, the infection did not survive on the grass for twenty-four hours under the conditions existing.

INFECTIVENESS OF FÆCES SPRINKLED ON GRASS

Experiment 23.—This experiment was designed to test the duration of vitality of rinderpest virus in fæces diluted in water and spread on grass. Material was collected from bull 3448.

On June 26, at 5 p. m., which was the sixth day after inoculation and fourth day of febrile temperature, 550 cubic centimeters of fæces were collected and diluted to 1,500 cubic centimeters. This mixture was sprinkled on the grass which was left for twenty-four hours, during which time the weather was rainy. At the expiration of this period, bull 3392 was picketed on the spot for twelve hours, after which it was removed and placed in a screened shed. The first rise of temperature occurred on July 2, while diarrhœa and inappetence occurred on July 5. Death from rinderpest occurred on July 9.

On July 30, 1912, which was the tenth day after injection and eighth day after rise of temperature—and two days before death—600 cubic centimeters of fæces were collected and diluted to 1,000 cubic centimeters in water. This was sprinkled on the grass at 4.15 p. m., after which the grass plot was left for twenty-four hours, during which time the sky was cloudy at times. Following this interval, bull 3399 was placed on the grass for twelve hours, after which it was isolated in a screened stall. No disease developed, and afterward the animal was proved to be susceptible.

It is concluded that the rinderpest virus in the fæces remained infective on the grass for twenty-four hours at an early stage of the disease, but not at a later stage.

INFECTIVENESS OF FÆCES AND URINE AT VARIOUS STAGES OF AN ATTACK

Experiment 24.—This experiment was designed to determine on what days fæces and urine from carabaos suffering from rinderpest are infective to cattle. For this purpose fæces and urine were obtained from carabao 3177 during an attack of rinderpest, on the fifth day after inoculation and first day of febrile temperature. The details of the work appear in the notes below:

August 21, 1911. Two hundred cubic centimeters of urine from 3177 were given as a drench to 3133, which was immediately afterward isolated in a screened stall.

August 22. Two hundred cubic centimeters of fæces from 3177 and water in equal parts were given as a drench to 3117, which was immediately isolated.

August 23. No fæces nor urine were collected on this date.

August 24. No fæces nor urine were collected on this date.

August 25. Two hundred cubic centimeters of urine from 3177 were given to 3157 as a drench, after which it was isolated.

August 26. Two hundred cubic centimeters of urine from 3177 were given to 3121 as a drench, after which it was placed in isolation.

August 27. Two hundred cubic centimeters of fæces from 3177 and water in equal parts were given to 3125 as a drench, after which it was isolated.

August 28. Two hundred cubic centimeters of urine from 3177 were given to 3192, which was then isolated.

It was decided, on account of the expense, not to attempt to infect more animals from 3177, but to use the results obtained in this experiment as a guide for future work.

TABLE X.—Tests of infectivity of fæces and urine.

Date.	Animal No.	Material.	Result.	Susceptibility test.
Aug. 21....	3, 133	Urine.....	Negative ...	Susceptible. Do.
Aug. 22....	3, 117	Fæces.....	do	
Aug. 23....				
Aug. 24....				
Aug. 25....	3, 157	Urine.....	Positive ...	Susceptible.
Aug. 26....	3, 121	do	do	
Aug. 27....	3, 125	Fæces.....	Negative ...	
Aug. 28....	3, 192	Urine.....	Positive ...	

The relation existing between the stage of the disease and the infectivity of the fæces and urine is shown in graphic form on the temperature chart of 3177. Plus or minus signs indicate whether or not fæces and urine collected on the respective days induced the disease in other animals.

The disease apparently had not progressed enough on August 21 and 22 to render infective the urine and fæces tested on these dates, respectively. Fæces were noninfective on August 27, while urine of the next day was infective.

DURATION OF INFECTIVENESS OF VIRUS IN WATER

Experiment 25.—This experiment was designed to furnish data as to the duration of viability of rinderpest virus in fæces and urine when mixed with water.

Fæces and urine were collected on September 23, 1911, from bull 3207, on the ninth day after inoculation and the fifth day succeeding the initial rise of temperature. The animal had experienced an acute attack of rinderpest, and died the same day. Some of the fæces were gathered at autopsy. The same material was also collected from bull 3194 on the day of death, which was the eighth day since inoculation with virulent blood and the sixth day following the initial rise of temperature.

A mixture of fæces and urine from 3207 and 3194 was placed in a keg in equal parts with water, and the mixture was placed in the shade.

Two hundred cubic centimeters of this mixture were administered as a drench to a control animal, which was isolated in a screened stall. This animal contracted rinderpest in the usual time.

Thirty-six hours later, 3209 received an equal amount of the diluted faeces and urine, was isolated, and developed rinderpest in the usual time.

At sixty hours, 3211 was given a similar dose. This animal failed to develop rinderpest.

On the eighty-fourth hour, 3213 received a similar dose, but failed to become infected.

Bull 3215 was exposed in a similar manner at one hundred eight hours, and gave negative results.

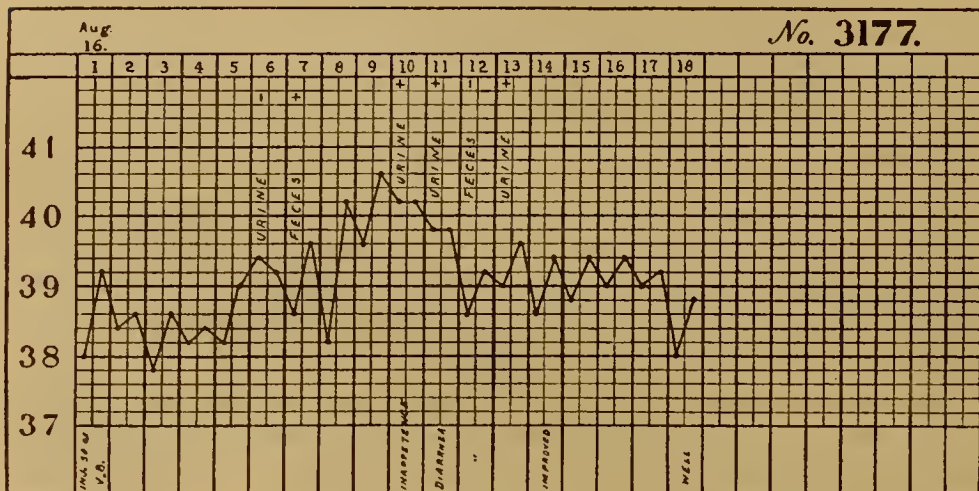

The susceptibility of bulls 3211, 3213, and 3215 was proved subsequently.

The results are presented in Table XI.

TABLE XI.—Tests of viability of virus in faeces and urine mixed with water.

Animal No.	Age of mixture.	Result.	Susceptibility test.
	<i>Hours.</i>		
Control	Fresh.	Positive	
3209	36	do	
3211	60	Negative	Susceptible.
3213	84	do	Do.
3215	108	do	Do.

It is concluded that rinderpest virus from faeces, mixed with water, survived only thirty-six hours.

INFECTIVENESS OF ANIMALS AFTER RECOVERY

Experiment 26.—The question of whether or not apparently recovered animals continue to spread infection afterward, like "bacillus carriers," is highly important in connection with combating the disease. The assembling of 58 head of cattle that had been infected with rinderpest for a period varying from three weeks to three months previously gave opportunity to test the matter. Three susceptible bulls, 2998, 3053, and 3065, were placed among them at pasture on May 16, 1911, and removed June 9, after an interval of twenty-five days. They did not contract rinderpest, but later their susceptibility was proved by attack with rinderpest after suitable exposure.

It is concluded that apparently recovered animals capable of spreading rinderpest by natural exposure were not present among the 58 head tested.

GENERAL RESULTS BY EXPERIMENTS

Experiment 1.—A corral which had contained many cattle and carabaos infected with rinderpest during the preceding three months and also three sick animals during the fifteen days preceding the removal of the sick did not prove infective to susceptible animals placed therein twenty-four hours after the removal of the infected animals. The corral was bare of vegetation, was but scantily shaded, and contained a carabao wallow. The weather was generally clear. Six different susceptible animals were used to test the infectivity of the corral at various intervals varying from one to fourteen days after the sick were removed, and they each were kept in the corral for periods varying from one to four days.

Experiment 2.—There was employed a corral well shaded by a tree, but containing little or no vegetation. Infected animals had been in the area for nineteen days before all were removed. Four susceptible animals were employed to test the infectiveness of the corral, with negative results. Intervals of from one to eleven days elapsed after the removal of the sick before admitting the test animals, which were kept therein. The weather was generally clear with little rain.

Experiment 3.—The same corral, as in the preceding experiment, was employed, but the weather was cloudy and rainy. Four susceptible animals failed to contract rinderpest after intervals of one and two days, after the removal of the sick ones. They were left in the corral for periods of three and four days.

Experiment 4.—In this case the corral used in the first exper-

iment was employed. Conditions were changed slightly by covering the carabao wallow on top and on three sides with a grass thatching. The weather was generally dry. Four test animals failed to contract rinderpest when exposed in the corral at intervals of one, three, five, and seven days after the removal of the sick. They were left in the corral for periods varying from one to seven days.

Experiment 5.—The corral used in experiment 2 was employed, but the weather was uniformly hot and dry. Three susceptible animals were used to test the infectivity of the corral at intervals of one, two, and three days after the removal of the sick, but negative results were obtained. The test animals were left in the corral for intervals of two, three, and four days.

Experiment 6.—The same corral as in the preceding experiment was employed, but some rain fell during the period of the test. Three susceptible animals were exposed at intervals of one, two, and three days after removal of the sick ones, and negative results were obtained. They were left in the corral for periods of five, six, and seven days, respectively.

Experiment 7.—The same corral was employed as in the two preceding experiments, but the ground was kept constantly moist to simulate wet weather. Three susceptible animals were exposed in the corral at intervals of one, one and one-half, and two days after the removal of the sick animals. They were left in the corral for four, four and one-half, and three days, respectively, but negative results were obtained.

Experiment 8.—The tests were made in the same corral as in the experiments immediately preceding, and the presence of infection at the time the sick were removed was demonstrated by a control animal. This animal became infected some time within twelve hours after the sick animals were removed. Two other susceptible animals failed to contract rinderpest after exposure at thirty-six and forty-eight hours' interval following the removal of the sick. They were left in the corral for forty-eight and twenty-four hours, respectively.

Experiment 9.—The surroundings of this experiment were similar to those of the preceding ones. One susceptible animal was exposed in the corral at twenty-four hours after a sick one had been removed, and was left there for twenty-four hours, with negative results.

Experiment 10.—This experiment was similar to the preceding ones with regard to surroundings, but the infectiveness of the corral was tested at intervals of twenty-four hours or less after the removal of the sick animals. One animal exposed

at half an hour and left in the corral for seven days contracted rinderpest. Another exposed at seventeen and one-half hours and left for six days contracted rinderpest. Two placed in the corral twenty-four hours after the sick animals were removed, and left there six days each, failed to contract rinderpest. The results emphasize the fact that rinderpest virus perishes in a bare corral in less than twenty-four hours.

Experiment 11.—Two head of cattle infected with rinderpest and confined in a small inclosure were found to be infective to other cattle by contact on the seventh, eighth, ninth, and tenth days, reckoned from and including the date that they were injected with virulent blood. This period coincided with the decrease of febrile temperature regularly exhibited in cases of rinderpest and included the period when symptoms were most marked. Subsequent to the period of temperature decline, neither the surviving infected animal nor the infected surroundings of the animal communicated the disease to susceptible animals exposed thereto.

The experiment is important in defining the infective period of a case of rinderpest and in demonstrating that virus does not remain infective in a corral beyond twenty-four hours. The results emphasize the importance of close association of animals in transmitting rinderpest.

Experiment 12.—A carabao and a bull infected with rinderpest and kept together in a small corral transmitted the disease at eight, ten, eleven, twelve, and thirteen days after they had been injected with virulent blood. This period corresponded to the stage of an attack of rinderpest, extending from the second day of febrile temperature until the final fall of temperature. It was again shown that neither the surviving animal after the decline of temperature nor its surroundings were capable of transmitting the disease to susceptible animals. The results confirmed those of the previous one as to the infective period and as to the failure of the infected corral to transmit the disease.

Experiment 13.—A carabao infected with rinderpest was shown to be infective by contact to other susceptible carabaos at ten, eleven, and fourteen days after inoculation. The corral was not infective on the day following the death of the infected animal. The results verify those of the two preceding experiments.

Experiment 14.—The blood of an animal during an attack of rinderpest was shown to be capable of transmitting the disease at seven, nine, and eleven days after it had been injected

with virulent blood. Tests made at five, thirteen, fifteen, seventeen, nineteen, and twenty-one days gave negative results.

Experiment 15.—The blood of an animal infected with rinderpest was shown to transmit the infection at six, eight, ten, twelve, fourteen, and sixteen days after it had been injected with virulent blood.

Experiment 16.—Urine collected from an animal on the seventh day of febrile temperature was diluted with an equal amount of water and sprinkled on a grass plot. An animal grazing over the grass plot twenty-four hours later failed to contract rinderpest.

Experiment 17.—Urine from infected animals, at stages of attacks of rinderpest corresponding to the fourth and eighth days of febrile temperature, was diluted in water and sprinkled on grass. An animal that grazed on the spot thirty-six hours later contracted rinderpest.

Experiment 18.—Urine from an animal six days after inoculation in the third day of febrile temperature of an attack of rinderpest was sprinkled on a grass plot. An animal that grazed thereon forty-eight hours later did not contract the disease. Tests were made of the same urine at seven and eleven days after inoculation, the grass plot being left unoccupied twenty-four hours, but negative results were obtained.

Experiment 19.—Urine of two animals both at a stage of an attack of rinderpest corresponding to the sixth day after inoculation and third day of febrile temperature was mixed, diluted with water, and sprinkled on grass, but did not cause infection. Urine of another animal seven days after inoculation gave negative results.

Experiment 20.—Urine from an animal five days after inoculation and two days after initial rise of temperature, when diluted with water and sprinkled on grass, proved to be infective after thirty-six hours.

Experiment 21.—Urine from an animal eight days after inoculation, two days after initial rise of temperature, did not remain infective on grass after thirty-six hours.

Experiment 22.—Urine and fæces together, from an animal eight days after inoculation, three days after rise of temperature, when diluted with water and sprinkled on grass, did not prove infective forty-eight hours later. Fæces from the same animal twelve days after inoculation did not prove infective after lying on grass for twenty-four hours.

Experiment 23.—Fæces from an animal six days after inocu-

lation, four days after rise of temperature, when diluted with water and sprinkled on grass, proved to be infective twenty-four hours later. Fæces from the same animal ten days after injection, when tested in the same manner, gave negative results.

Experiment 24.—Fæces were collected from an animal during an attack of rinderpest at seven and twelve days after inoculation and administered to susceptible animals. The first sample only yielded positive results. Urine collected at six days gave negative results, but that collected at ten, eleven, and thirteen days produced the disease.

Experiment 25.—Fæces and urine were collected from an animal during an attack of rinderpest nine days after inoculation, five days after rise of temperature. The same material was collected from a case eight days after inoculation, six days after rise of temperature. All was diluted with equal parts of water in a keg in the shade. Rinderpest was produced in animals to which this mixture was administered, immediately, and after thirty-six hours. Tests made at sixty, eighty-four, and one hundred eight hours yielded negative results.

Experiment 26.—Forty-eight animals that had experienced attacks of rinderpest within three months previously were mixed with 3 susceptible animals for twenty-five days without evidence being produced that they were capable of transmitting the disease.

CONCLUSIONS

1. Rinderpest virus was not shown to have survived beyond twenty-four hours in corrals bare of vegetation but containing water. The conditions under which tests were made included all seasons of the year with accompanying variation in sunlight, rain, and condition of the soil. The amount of shade varied widely.

2. Animals became infected in such corrals within half an hour, twelve hours, and seventeen and one-half, respectively, after removal of the sick.

3. Animals infected with rinderpest were shown to be capable of transmitting the disease to susceptible animals by close contact only during the febrile period of the disease, and most certainly during the period in which the temperature was declining. The disease was not contracted by susceptible animals when exposed to sick animals during the convalescent stage when the temperature was nearly normal.

4. Blood of animals infected with rinderpest was shown in two cases to be infected during the height of the febrile period.

5. The virus in urine, diluted with water and sprinkled on grass, was demonstrated to survive for thirty-six hours in some instances, but not always, and not for a longer period of time.

6. Fæces mixed with water and sprinkled on grass infected an animal twenty-four hours later.

7. Fæces and urine diluted with water and kept in a vessel in the shade remained infective for susceptible animals for thirty-six hours, but no longer.

8. No evidence was secured to show that recovered cases transmit the disease.

9. The foregoing facts indicate that the virus of rinderpest perishes soon after being discharged by the infected animal.

10. Nothing in the foregoing experiments indicates that rinderpest virus is harbored for long periods upon the soil of contaminated areas.

REFERENCES

- (1) RÉFIK-BEY and RÉFIK-BEY. La peste bovine en Turquie. *Ann. Inst. Pasteur* (1899), 13, 596.
- (2) EDINGTON, A. A retrospect of the rinderpest campaign in South America. *Lancet* (1899), 1, 357.
- (3) STOCKMAN, S. Report on work of veterinary department since May, 1903. *Annual Rep. Transvaal Dept. Agr.* (1903-1904), 67.
- (4) YERSIN, A. Étude sur quelques épizooties. *Bull. économ.* (1904), n. s. 6, 241.
- (5) RUEDIGER, E. H. Observations on cattle plague in the Philippines and the methods employed in combating it. *Phil. Journ. Sci., Sec. B* (1909), 4, 381.
- (6) HUTYRA und MAREK. *Spezielle Pathologie und Therapie der Haustiere.* G. Fischer, Jena (1910).

ILLUSTRATIONS

PLATE I

- FIG. 1. Corral 1, used for determining the length of time that infection of rinderpest remains alive after the removal of infected animals.
2. Corral 2, used for determining the length of time that rinderpest virus remains alive after the removal of infected animals.

PLATE II

Corral 3, used for securing close contact of animals to determine the relation existing between the period of infectiveness and the stage of the disease.



Fig. 1. Corral 1, used for determining the length of time that infection of rinderpest remains alive after the removal of infected animals.



Fig. 2. Corral 2, used for determining the length of time that rinderpest virus remains alive after the removal of infected animals.



PLATE II. CORRAL 3, USED FOR SECURING CLOSE CONTACT OF ANIMALS TO DETERMINE THE RELATION EXISTING BETWEEN THE PERIOD OF INFECTIVENESS AND THE STAGE OF THE DISEASE.

INTESTINAL PARASITISM, PARTICULARLY ENTAMŒBIASIS,
IN PATIENTS OF THE PHILIPPINE GENERAL
HOSPITAL, MANILA, P. I.

By DAVID G. WILLETS

(From the Biological Laboratory, Bureau of Science, Manila, P. I.)

TABLE I.—Summary of findings.

Examinations and infections.	Number.	Per cent.
Persons examined.....	1,000	
Persons infected.....	848	84.8
Persons infected with:		
<i>Trichuris</i>	606	60.6
<i>Ascaris</i>	465	46.5
<i>Entamœba</i>	375	37.5
Hookworm.....	187	18.7
Monad.....	92	9.2
<i>Strongyloides</i>	13	1.3
Cestode.....	10	1.0
<i>Oxyuris</i>	2	0.2
<i>Balantidium</i>	2	0.2
Total infections.....	1,752	175.2

In his investigations on experimental entamœbic dysentery, Walker¹ drew, among others, the conclusions: (1) That the nonpathogenic *E. coli* and the pathogenic *E. histolytica* can be readily differentiated by the experienced microscopist in the active stage, as seen in dysenteric (not diarrhœal) stools and in the encysted stage encountered in formed stools and (2) that the distinction between the pathogenic *E. histolytica* and the harmless *E. coli* having been established, there no longer exists an excuse for the indiscriminate treatment of all persons who show entamœbæ in their stools. Granting that these deductions are valid, their practical importance rests upon two factors; namely, (1) the percentage of individuals harboring entamœbæ and (2) the percentage of persons infected with *E. coli* only.

These considerations induced me to make the examinations herein recorded. The objects of the work are to determine (1) the frequency of infection with entamœbæ in patients entering

¹ *This Journal, Sec. B* (1913), 8, 253.

the Philippine General Hospital and (2) the relative percentage of infection with *E. coli* and *E. histolytica*. Incidentally evidences of infection with intestinal parasites other than entamœbæ were noted.

The helminthic findings may be compared with those obtained in other statistical studies of fæces in the Philippines for intestinal helminthiasis by consulting a table which was compiled by me.²

A criticism which may be made of many statistical studies is that the conditions under which the data are secured, and which, therefore, limit the conclusions drawn, are not defined clearly. To avoid this, factors limiting the present investigation are given as carefully as possible.

1. The persons examined were all inside hospital patients admitted during 1913. The vast majority of them were residents of Manila. Some were victims of entamœbic dysentery, but these constituted only a small percentage of the whole number examined.

2. Two thin cover-slip preparations of the one specimen obtained from each case were examined. This is obviously a meager examination. If more preparations had been examined of each specimen and particularly if repeated examinations had been made of negative cases, I am sure the positive percentage obtained would have been augmented considerably.

3. The stool specimens were collected by the regular hospital routine method as follows:

Unless otherwise specifically ordered, a patient is given a dose of magnesium sulphate the morning after admission and a portion of the first liquid stool obtained thereafter is sent to the laboratory within an hour for examination. If a patient has diarrhœal or dysenteric symptoms, the first stool secured during laboratory hours is sent to the laboratory by special messenger. Since it was impracticable to examine all stools particularly for entamœbæ, it was determined before a specimen was seen by the examiner whether it could be so examined, an operation which requires more time than ordinary routine examination. When a specimen from a patient having diarrhœal or dysenteric symptoms arrived at the laboratory, it was included in the 1,000 cases only provided that the next specimen, regardless of its nature, would have been included in the series. Thus the cases were unselected, but they may not represent a true average of those entering the hospital.

² *Ibid* (1911), 6, 77.

TABLE II.—Distribution of the infections according to nationality, age, and sex.

Examination and infections.	Filipinos.						Americans.						Total.		
	Num-ber.	Per cent.	Adults.			Children.	Per cent.	Adults.			Per cent.	Num-ber.	Per cent.	Num-ber.	Per cent.
			Num-ber.	Per cent.	Female.			Num-ber.	Per cent.	Female.					
Persons examined	900			383	417	100			71	29		1,000			
Persons infected	802	89.1	728	91.0	390	74	74.0	46	38	13	44.8	848	84.8		
Persons infected with:															
One species	242	26.9	221	27.6	99	21	21.0	31	22	9	30.9	273	27.3		
Two species	309	34.3	283	35.4	155	26	26.0	12	8	4	13.9	321	32.1		
Three species	183	20.3	162	20.3	99	21	21.0	3	3			186	18.5		
Four species	61	6.8	56	7.0	34	5	6.0					61	6.1		
Five species	7	0.8	6	0.7	3	1	1.0					7	0.7		
<i>Trichuris</i>	598	64.4	539	67.4	242	59	59.0	8	7	1	3.4	606	60.6		
<i>Ascaris</i>	450	50.0	393	49.1	251	57	57.0	15	9	6	20.7	465	46.5		
<i>Endameba</i>	349	38.8	324	40.5	193	25	25.0	26	18	8	27.6	375	37.5		
Hookworm	182	20.2	170	21.3	118	12	12.0	5	5			187	18.7		
Monad	85	9.4	79	9.9	54	6	6.0	7	5	2	6.9	92	9.2		
<i>Strongyloides</i>	12	1.3	12	1.5	5			1	1			13	1.3		
Cestode	8	0.9	6	0.8	3	2	2.0	2	2			10	1.0		
<i>Oxyuris</i>	2	0.2	2	0.3	1	0.2						2	0.2		
<i>Balantidium</i>	2	0.2	2	0.3	1	0.2						2	0.2		
Total	1,688	187.6	1,527	190.9	857	161	161.0	64	47	17	59.0	1,752	175.2		

4. Three stages of entamœbæ were recognized; namely, encysted (partly or completely), active, and quiescent. No stains were used. The examinations were made with a Leitz 3 objective (a Leitz 6 and an immersion lens being used when necessary) and a 4 ocular.

A summary of the findings is given in Table I. The distribution of the infections according to nationality, age, and sex is found in Table II.

This table shows that 375, or 37.5 per cent of the 1,000 cases examined, were infected with entamœbæ, the highest percentage, 46.3, being found in adult female Filipinos and the lowest, 25.0, in Filipino children. Experience gained at the hospital during the past two years inclines me to the belief that if several specimens from each case had been examined the percentage of persons infected would have been about one-half as high again as given above. In other words, instead of the positive percentage being 37.5 it would have been about 55.

The percentage of entamœbic infections in inhabitants of the Philippine Islands recorded by other investigators and the conditions under which they were obtained are given in Table III.

Strong,³ 1901, looking for *E. coli* in the stools of nondysenteric persons of Manila, found 8, or 4 per cent, infected in 200 examinations. Vedder,⁴ 1906, examined 100 healthy individuals in the Cotabato Valley, Mindanao Province, for the presence of *E. coli*. Of 50 native scouts, mostly Moros, 35, or 70 per cent, and of 50 American soldiers, 25, or 50 per cent, were infected. Ashburn and Craig,⁵ 1907, examined 107 healthy American soldiers at the Division Hospital, Manila, for entamœbæ. They found *E. coli* in 76, or 71 per cent, and *E. histolytica* in 4, or 3.7 per cent. Hoyt,⁶ 1908, reported 34.6 per cent infected of 300 persons examined for active entamœbæ at the Naval Hospital, Cañacao, Cavite Province. Of 283 American sailors, 32 per cent, and of 17 Filipinos, 76 per cent, were positive. Garrison,⁷ 1908, in examining 4,106 inmates of Bilibid Prison, Manila, for general evidences of intestinal parasitism, found 23 per cent infected with active entamœbæ. In a similar study Garrison, Leynes, and Llamas,⁸ 1909, found 2.7 per cent infected with

³ Circular on Tropical Diseases, No. 1. Manila (Feb., 1901).

⁴ *Journ. Am. Med. Assoc.* (1906), 40, 870.

⁵ *Milit. Surgeon* (1907), 21, 348.

⁶ *This Journal, Sec. B* (1908), 3, 417.

⁷ *Ibid.* (1908), 3, 191.

⁸ *Ibid.* (1909), 4, 257.

active entamœbæ among 1,000 inhabitants of Taytay, Rizal Province. Rissler and Gomez,⁹ 1910, report 0.39 per cent positive for entamœbæ of 6,018 persons examined at Las Piñas, Rizal Province, for evidence of intestinal parasitism, particularly hookworm infection. In similar investigations the same men found not a single entamœbic infection among 2,549 persons examined at Tuguegarao, Cagayan Province, and 802 examined at Santa Isabel, Ilagan, Isabela Province. Stitt,¹⁰ 1911, examined 100 Filipinos of the outdoor clinic of the Naval Hospital, Cañacao, Cavite Province, for entamœbæ, finding 9 per cent positive.

In the consideration of these investigations it is important to note several factors. In some of them fresh liquid stools obtained by the administration of a saline cathartic were examined, whereas in others fresh or old normal stools were used. The number of specimens examined of each case was not mentioned in a single instance. The number of cover-glass preparations examined of each specimen was usually not stated. The kind of infections sought varied considerably. Also, the stage of development required for a diagnosis was not given in some instances, and in no case were active, quiescent, or encysted forms recognized.

The data are given more concisely in Table III.

TABLE III.—*Percentage of entamœbic infections and the conditions under which they were obtained by various authorities.*

Authority and date.	Exam-ined.	Infected.	Place.
		<i>Per cent.</i>	
Strong, 1901	200	4.00	Manila.
Vedder, 1906.....	50	70.00	Cotabato Valley, Mindanao.
	50	50.00	Do.
Ashburn and Craig, 1907	107	71.00	Manila.
Hoyt, 1908	283	32.00	Cañacao, Cavite.
	17	76.00	Do.
Garrison, 1908	4,106	23.00	Manila.
Garrison, Leynes, and Llamas, 1909	1,000	2.70	Taytay, Rizal.
	6,018	0.39	Las Piñas, Rizal.
Rissler and Gomez, 1910	2,594	-----	Tuguegarao, Cagayan.
	802	-----	Santa Isabel, Ilagan, Isabela.
Stitt, 1911	100	9.00	Cañacao, Cavite.

⁹ *Ibid* (1910), 5, 267.

¹⁰ *Ibid* (1911), 6, 211.

TABLE III.—Percentage of entamæbic infections, etc.—Continued.

Race.	Sex.	Age.	Species.		Stage required for diagnosis.
			<i>E. coli.</i>	<i>E. histolytica.</i>	
(?)	(?)	(?)	Per cent.	Per cent.	(?)
Filipinos	Males	Adult	4	(?)	(?)
Americans	do	do	70	(?)	Active. Possibly quiescent.
Do	do	do	50	(?)	Do.
Do	do	do	71	3.7	Active or encysted.
Filipinos	do	do	undifferentiated.		Active.
Mixed, mostly Filipinos ..	Mostly males ..	do	undifferentiated.		Do.
Filipinos	Mixed	Mixed	undifferentiated.		Do.
Mostly Filipinos	do	do	undifferentiated.		(?)
Filipinos	do	do	undifferentiated.		(?)

Infections sought.	Preparations examined of each specimen.	Specimen examined of each case.	Character of specimen.			
			After saline cathartic.	Normal.	Fresh.	Old.
<i>E. coli</i>	(?)	(?)	(?)	(?)	(?)	(?)
Do	(?)	(?)	Yes		Yes	
Do	(?)	(?)	Yes		Yes	
Entamæbic	(?)	(?)	Yes		Yes	
Do	(?)	(?)	Yes		Yes	
Do	(?)	(?)	Yes		Yes	
General	1	(?)	Yes		Yes	
Do	1	(?)	Mostly ..	Some ..	Mostly ..	Some.
Hookworm	1	(?)		Yes		Yes.
Entamæbic	(?)	(?)		Yes		Yes.

A glance at this table will suffice to convince one that the results obtained by the different authorities quoted cannot be rigidly compared, since no two of them have worked under precisely the same conditions with exactly the same object in mind. It is believed that these factors explain in a large degree the wide differences in the percentages of entamæbic infection reported; namely, from 0 to 76 per cent.

Among the factors to be considered in making examinations for entamæbæ not the least important is the stage of development upon which a diagnosis is rendered. The time is at hand when a diagnosis should be given not only upon the presence of active, but also upon that of quiescent or encysted forms. It is my experience that active forms only or encysted forms only may be present in a specimen. The quiescent forms, on the

other hand, may be associated with either active or encysted stages—sometimes with both of them. In dysenteric stools, whether they be entamœbic or of other variety, active forms are encountered almost invariably in this climate if the specimen be not over one hour old. In soft or in artificially produced diarrhœal stools, such as those obtained after a saline cathartic, active, quiescent, and some encysted forms are found, quiescent forms being the most frequent numerically. In hard, formed stools only encysted stages appear ordinarily. Old, liquid, or soft stools are not suitable for examination for the reason that active and quiescent entamœbæ degenerate and disappear within a few hours. It has been my repeated experience to find such specimens which I had saved in the morning for purposes of demonstration to be absolutely negative in the afternoon. Hard, formed stools may be examined for encysted entamœbæ any time within two or three days after being obtained.

The ability to recognize active, quiescent, and encysted entamœbæ, after they have once been demonstrated to him, is readily acquired by one who is familiar with stool examinations. The active forms are identified by their characteristic movements. Walker¹¹ has given the following description of the quiescent and encysted form:

The resting entamœba is distinguished from other bodies found in the stool by its size, distinctness, regularity of contour, degree of refractiveness, and especially by its nuclear structure. The entamœbæ vary in size within considerable limits, but are usually from 20 to 30 microns in diameter. They are, therefore, larger than pus cells, or other protozoa, with the exception of *Balantidium coli*, that are found in the stools of man. They are also more refractive than pus, epithelial, or other cells found in the stools. The nuclear structure of the entamœbæ is particularly characteristic. The unencysted entamœba possesses, unless in the process of division, only a single nucleus. This nucleus is round, or occasionally slightly oval or irregular, small with reference to the size of the cell, and appears not solid but as a refractive ring. This relatively small, ring-shaped nucleus appears to be absolutely diagnostic of an entamœba. Only one other kind of cell observed in stools possesses a nucleus in any way resembling that of an entamœba. This is an epitheloid cell, sometimes found in mucous stools, which has a ring-form nucleus relatively much larger than that of an entamœba, occupying one-fourth to one-half of the cell. While an entamœba may occasionally be observed with an abnormally large nucleus, probably preparatory to division, the nucleus never approaches the size of the nucleus of this epitheloid cell. The latter cells are also less refractive and granular than entamœbæ.

The encysted entamœba is round or slightly oval, more refractive than the resting or motile stage, and is surrounded by a more or less distinct

¹¹ *This Journal, Sec. B* (1913), 8, 310.

cyst wall. The nuclear structure here also is characteristic. The cyst contains several (from 2 to 8, depending upon the species of *entamœba* and the stage of development of the cyst) ring-form nuclei usually smaller than, but of the same structure as, the nucleus of the motile *entamœba*.

I desire to add that the *entamœbic* cyst wall is of a whitish color and the rest of it is almost invariably of a greenish tint under the 3 objective.

DIFFERENTIAL DIAGNOSIS

In the performance of the work herein recorded, I have repeatedly made provisional differential diagnosis upon quiescent and active *entamœbæ* occurring in ordinary and in diarrhœal stools, particularly those produced artificially by magnesium sulphate. Subsequently, formed stools were obtained from those cases, and differential diagnosis rendered upon encysted *entamœbæ*. The exact number of cases in which this procedure was adopted cannot be given, but certainly it was not less than fifty. The result was a thorough conviction that ordinarily I, at least, cannot make a correct differential diagnosis upon either the quiescent or active forms in question. While active organisms seen in pronounced dysenteric stools can usually be differentiated, the one stage of development in which two distinct species can be discerned is the completely encysted one. For the detailed points of differentiation of the two species, the reader is referred to Walker's article.¹² Walker summarizes the differential points in a general way as follows:

Motile stage.

<i>A. Entamœba histolytica.</i>	<i>B. Entamœba coli.</i>
1. Appearance hyaline.	1. Appearance porcelaneous.
2. Refractiveness more feeble.	2. Refractiveness more pronounced.
3. Movements active in the fresh stools.	3. Movement sluggish.
4. Nucleus more or less indistinct.	4. Nucleus distinct.
5. Chromatin of nucleus scanty.	5. Chromatin of nucleus abundant.

Encysted stage.

<i>A. Entamœba histolytica.</i>	<i>B. Entamœba coli.</i>
1. Cyst smaller.	1. Cyst larger.
2. Cyst less refractive.	2. Cyst more refractive.
3. Cyst usually contains elongated refractive bodies known as "chromidial bodies."	3. Cysts do not contain "chromidial bodies."
4. Nuclei never more than 4.	4. Nuclei 8, occasionally more.
5. Cyst wall thinner.	5. Cyst wall thicker.

¹² *Ibid* (1913), 8, 317.

The difference in size of the cysts of the two species is very helpful in making a differential diagnosis. Size alone, however, is not dependable for the reason that small *E. coli* cysts are found at times. Large 4-nucleated cysts have not been seen by me unless encystment was obviously incomplete. Since the nuclei lie in different plains, doubt occasionally exists as to the number of nuclei present in a given cyst. By using gentle pressure on the cover glass, the cyst wall can be broken and the escaped nuclei, lying just outside of the cyst wall, counted. Another practical point in differentiating entamoebic cysts is the manner in which a preparation is made for examination. It is my custom to make a thin preparation and to draw off the excess water with a piece of filter paper so that the cover glass fits snugly to the specimen. Thus the cysts are flattened out somewhat and the counting of the nuclei facilitated. This manner of making a cover-slip preparation also lessens the probability of the cyst shifting to another field when the oil immersion lens, which must always be used to make a reliable differential diagnosis, is applied.

Using Walker's findings as a basis, a differential diagnosis was made upon cysts found in 76 cases. Completely encysted forms with 4 nuclei were called *E. histolytica*, and those with 8 or more nuclei were called *E. coli*. The results obtained are given in Table IV.

TABLE IV.—*Differential diagnoses rendered upon encysted forms of entamæba in 76 cases.*

Species.	Number.	Per cent.
<i>Entamæba coli</i> and <i>E. histolytica</i> present	45	59.2
<i>Entamæba coli</i> only present.....	27	35.5
<i>Entamæba histolytica</i> only present.....	4	5.3
<i>Entamæba coli</i> present	72	94.7
<i>Entamæba histolytica</i> present.....	49	64.5

In making the differentials, 4 cover-glass preparations were examined before a specimen was said to be negative for either *E. coli* or *E. histolytica* if cysts were plentiful; 10 cover-glass preparations, if cysts were scarce. In some instances a second specimen was examined because doubtful forms were encountered in the first one. *In the vast majority of the cases presenting a double infection, E. coli cysts greatly outnumbered E. histolytica cysts.*

Data with which the foregoing results would naturally be

compared are furnished by Vedder¹³ and Ashburn and Craig¹⁴ (compare Table III). Their differential diagnoses, however, are open to the criticism that they were made upon forms found in stools obtained by the administration of magnesium sulphate. It is noteworthy that Vedder recorded not only *E. coli* infections, but also other evidences of intestinal parasitism. Apparently, not a single infection with *E. histolytica* was found, since none is given in his results. In as much as these investigators examined apparently healthy individuals and my series of cases is composed of hospital patients, it may be advanced that one would expect to find a higher percentage of persons infected with *E. histolytica* in the latter than in the former class of individuals. As a matter of fact only 6, or 8 per cent, of the 76 cases upon which a differential diagnosis was rendered entered the hospital because of dysenteric symptoms. All of these were infected with both *E. coli* and *E. histolytica*. Five of them were chronic cases and one was a slightly acute case. The differentials, of course, were made upon cysts found in formed stools obtained after the subsidence of the dysenteric symptoms.

It has been noted that the entamœbæ found in the evacuations of patients suffering from pronounced dysentery (as evidenced by the presence of entamœbæ in great numbers in the stools, by therapeutic results, and by anatomical findings at autopsy, when the cases did not yield to treatment) conformed almost exclusively to the description of active *E. histolytica*. In other words, these infections as a rule were apparently pure. According to the literature on the subject, this is a common finding in dysenteric stools, and it seems rather remarkable when compared with the results obtained in the 76 cases in which a differential diagnosis was made upon encysted entamœbæ. Of the 49 individuals infected with *E. histolytica*, the infection was pure in only 4, or 8.2 per cent, and associated with *E. coli* in 45, or 91.8 per cent. Six of these 45 cases, as already stated, entered the hospital because of entamœbic dysentery. Most of the remaining 39 cases may have been carriers, but surely some of them were destined to develop dysentery. In other words, the *E. histolytica* infection occurring in some of these individuals was in the incubation period. These considerations force me to raise the following questions, which have occurred to me repeatedly. What happens to an associated *E. coli* infection

¹³ *Journ. Am. Med. Assoc.* (1906), 40, 870.

¹⁴ *Milit. Surgeon* (1907), 21, 348.

when acute dysentery develops? Is it crowded out by the rapid multiplication of *E. histolytica*? Are there so many active *E. histolytica* present in dysenteric stools that the relatively few active *E. coli* are overlooked even in a careful search? Does the sluggishly moving, porcelaneous *E. coli* take on activity and a hyaline appearance in dysenteric stools so that it simulates *E. histolytica*, just as the latter changes in motility and general appearance so that it resembles the former in nondysenteric, unformed stools? If the evidence obtained in numerous investigations were less strong, would not the very frequent association of *E. coli* and *E. histolytica* cysts in nondysenteric individuals, the impossibility of accurately differentiating the quiescent and active entamœbæ found in nondysenteric stools including those obtained after the administration of a saline cathartic, and the almost exclusive occurrences of pure *E. histolytica* infections in the stools of persons suffering from entamœbic dysentery tempt one to believe that, after all, there is but one species of *Entamœba* in man and that its appearance varies under different circumstances? These are grave questions which demand answers.

SUMMARY

1. Entamœbic infections were found in 37.5 per cent of the 1,000 individuals examined, in 38.8 per cent of 900 Filipinos, in 26.0 per cent of 100 Americans, in 46.3 per cent of 417 adult female Filipinos, in 34.2 per cent of 383 adult male Filipinos, in 25.0 per cent of 100 Filipino children, in 25.4 per cent of 71 adult male Americans, and in 27.6 per cent of 29 adult female Americans. Double infections were found in 59.2 per cent, pure *E. coli* infections in 35.5 per cent, pure *E. histolytica* infections in 5.3 per cent, *E. coli* infections in 94.7 per cent, and *E. histolytica* infections in 64.5 per cent. If more stools had been examined of each patient, it is believed that the positive percentage would have been about 55 instead of 37.5.

2. Percentage of entamœbæ infection reported for the Philippine Islands by various investigators have varied from 0 to 76. This is believed to be explained in a large degree by the varying conditions under which the examinations have been made.

3. Diagnosis of entamœbic infection should be made not only upon the presence of active, but also upon that of quiescent or encysted forms.

4. The one safe stage of development for a differential diagnosis between *E. coli* and *E. histolytica* is the encysted form encountered in formed stools.

5. Differential diagnosis made upon encysted forms found in specimens from 76 individuals gave the following results: *Entamoeba coli* present in 94.7 per cent, *E. histolytica* in 64.5 per cent, *E. coli* only in 35.5 per cent, *E. histolytica* only in 5.3 per cent, and *E. coli* and *E. histolytica* both present in 59.2 per cent.

6. It is probable that in dysenteric stools active *E. coli* closely resembles active *E. histolytica* in motility and general appearance without a corresponding change in its nuclear structure.

PRELIMINARY REPORT ON THE TREATMENT OF ENTAMŒBIASIS
WITH IPECAC, EMETINE, AND NEOSALVARSAN AT THE
PHILIPPINE GENERAL HOSPITAL, MANILA, P. I.¹

By DAVID G. WILLETS

(From the Biological Laboratory, Bureau of Science, Manila, P. I.)

With the coöperation of COURT R. STANLEY and PERPETUO GUTIERREZ

(From the College of Medicine and Surgery, University of the Philippines,
and the Philippine General Hospital, Manila, P. I.)

INTRODUCTION

The brilliant success of Rogers(1-5) and others(6-22) in the treatment of entamœbic dysentery with hypodermic injections of emetine led us to test the efficacy of this drug as compared with that of ipecac in entamœbiasis. The work having been interrupted for the present, it is deemed advisable to make a preliminary report of the results obtained to date. Our series of cases consists of 132. Of this number, 27 were dysenteric and 105 were nondysenteric. Eleven of the dysenteric cases were treated with emetine hydrochloride (prepared by Burroughs, Wellcome and Company); 16, with ipecac. The nondysenteric cases were divided into 52 controls, 34 treated with ipecac, and 19 treated with emetine. Among the controls there were 8 cases of clinical syphilis with positive Wassermann reactions. The administration of neosalvarsan in these cases seemed to have such a prompt action in freeing the intestine of entamœbæ that they are considered separately.

Nondysenteric cases were included in our series partly because of the recent investigations of Walker(23) on experimental entamœbic dysentery. He found that *Entamœba histolytica* is the essential etiologic agent of entamœbic dysentery; that *E. histolytica* and *E. coli* can be differentiated in the encysted stage by the experienced microscopist; that carriers of *E. histolytica* are common; and that the incubation period in his experimental cases varied from twenty to ninety-five days with an

¹ Read before the Manila Medical Society, Dec. 1, 1913.

average of 64.8 days. Accepting these conclusions, it is evident that the occurrence of entamœbic dysentery in an infected individual can be prevented and that prophylaxis against carriers of *E. histolytica* can be attained by expelling the pathogenic entamœbæ from the intestine of all infected persons. The procedure in such cases would be either (1) to make a differential diagnosis between *E. coli* and *E. histolytica* and treat only those infected with the latter species, or (2) to treat all persons indiscriminately who are infected with entamœbæ. Positively to exclude *E. histolytica* from an infection is difficult. In order to do so it would be necessary, in our opinion, that a person of considerable experience with entamœbæ examine very carefully a number of cover-glass preparations of each of several formed stools from the infected person—an operation which would consume a great deal of time and patience. Furthermore, in the examination of the cysts in 76 cases, Willets² found a double infection in 59.2 per cent, a pure *E. coli* infection in 35.5 per cent, and a pure *E. histolytica* infection in 5.3 per cent. It follows that *E. coli* was present in 94.7 per cent and *E. histolytica* in 64.5 per cent of the infected individuals. Therefore, it seems to us that the prophylaxis of entamœbic dysentery by excluding *E. histolytica* from infections is impracticable for routine usage in this locality. It would consequently appear that expelling all entamœbæ from the intestinal tract of infected persons would be a more practicable method. In this connection it is necessary to note that it is commonly known that one may harbor an entamœbic infection without the development of entamœbic dysentery. Therefore, it is probable that only a small percentage of persons would submit to treatment in order to

² The following case is of interest as bearing on the question of the incubation period of entamœbic dysentery. Dr. W. P. H., an American interne of the Philippine General Hospital, was admitted to the ward on August 12, 1912, complaining of fever and headache. A routine stool examination disclosed cysts of both *E. coli* and *E. histolytica*. No treatment for the infection was given. On June 18, 1913, mild dysentery developed with streaks of blood and mucus in the evacuations. Subsequent to the subsidence of symptoms in response to ipecac and emetine treatments, *E. coli* and *E. histolytica* cysts were found repeatedly in the stools. Other examinations made at irregular intervals between August 12, 1912, and June 18, 1913, were constantly positive for entamœbæ. It would appear that the incubation period in this case was ten months or more. The occurrence of a new infection between August 12, 1912, and June 18, 1913, of course, is not excluded, but Doctor H. states he was exceedingly careful about his drinking water and food during this period.

avoid a dysentery of which there may be no danger whatsoever, unless the treatment be inexpensive, give good results quickly, and the method of administration be simple and unattended by prolonged unpleasant reaction.

THERAPEUTIC AGENTS NOW USED FOR ENTAMŒBIASIS

At the present time intestinal entamœbiasis is treated with (1) ipecac, (2) emetine, (3) neosalvarsan, and (4) bismuth. Reports of each and all of these treatments deal chiefly with their application to the symptomatic cure of dysenteric cases, whereas, in keeping with our knowledge of the incubation period of entamœbic dysentery and of the tendency of the dysenteric symptoms to recur, they should be applied also to the cleansing of the bowel of entamœbæ.

The well-known difficulties associated with the ipecac treatment prohibit it from being used extensively as a prophylactic agent.

The evidence accumulated in various parts of the world convincingly proves the power of emetine hydrochloride quickly to relieve the dysenteric symptoms of entamœbiasis; but its efficacy in absolutely cleansing the intestines of entamœbæ is undetermined, for the reason that its effect upon entamœbæ has not been sufficiently checked in many cases by laboratory examinations, as indicated in Table I.

Allan(6), Baermann and Heinemann(7), Gaide and Monzels(14), and Marchoux(20) found that entamœbæ were not expelled from the intestinal tract by the emetine treatment to the degree that the relief of clinical symptoms would lead one to suspect. Our results confirm their findings (see Tables VI and VIII).

It may be added that, with Laveran(24), we believe a large share of the credit for the beneficial results obtained by the use of emetine in entamœbiasis by whatsoever method of administration belongs to Vedder(25) whose experimental studies induced Rogers(3) to use it hypodermically.

The treatment of entamœbiasis with salvarsan or neosalvarsan seems to offer great possibilities. Ehrlich(26) said "Hata was able to cure (amœbic dysentery) with a single intravenous injection of salvarsan."

In his preliminary report of 12 cases of intestinal amœbiasis and amœbic dysentery treated by the intravenous injection of salvarsan, Winn(27) gives the following summary:

Immediately following, that is within twenty-four hours of, the intravenous injection of salvarsan we have seen the stools change from a mixture of pus and blood to those having a greenish bile color.

In every case but one the number of stools per day has been reduced from one-third to three-fourths in twenty-four hours.

Arsenic has been demonstrated in the stools and urine as early as five hours after administration and for as long as eighteen days.

In all cases except one we have seen the amœbæ disappear from the stools in from twenty-four to seventy-two hours.

Winn's work was carefully performed, numerous laboratory examinations for entamœbæ evidently being made, but the exact dates are not given. The report of the subsequent histories of these patients, which is promised, will be exceedingly interesting.

Milian(28) reports the rapid recovery of a case of amœbic dysentery in response to salvarsan.

Wadhams and Hill(29) report 3 cases of entamœbic dysentery treated with salvarsan with successful results. Their cases are, however, more or less indefinite. All of the patients were American soldiers who had contracted entamœbic dysentery in the Philippine Islands several years previously. The disease had apparently become chronic in each case. The report indicates that the authors never saw entamœbæ in the stools of two of the cases either before or after treatment and that in one of these the examination was made about one year after the administration of salvarsan. Entamœbæ were present before and absent after treatment in the remaining case, but the number of stools examined after treatment is not mentioned.

The results obtained in our 8 nondysenteric cases treated with neosalvarsan are given in Tables V and VIII. We believe that these results and those of Winn are too remarkable to be explained by mere coincidence. We are, therefore, inclined to believe that this treatment will prove to be the most efficacious of the four under discussion in actually curing dysenteric and nondysenteric entamœbiasis. If so, a drawback to its common use would be the cost of this therapeutic agent.

The bismuth, or better the bismuth-milk-saline, treatment of entamœbic dysentery caused by *E. histolytica* is advocated by Deeks(30) of the Ancon hospital, Ancon, C. Z. This author states that in 60 consecutive cases he has not had a single death unless some complication were present and that in 190 cases treated by this method there has been not one relapse. It is also stated that in only two of all the cases treated by this method were entamœbæ of the species *E. histolytica* found in the

stools later than the fourth day from the beginning of treatment. It is noteworthy that Deeks recognizes *E. histolytica* and *E. tetragena* as distinct causes of dysentery and seems to accept James' opinion that the bismuth-milk-saline treatment does not cleanse the bowel of entamœbæ of the species "*E. tetragena*." As a matter of fact, it is now generally accepted that *E. tetragena* and *E. histolytica* are identical. On the one hand, therefore, it appears that Deeks's findings relative to the power of the bismuth-milk-saline treatment to free the intestinal tract of *E. histolytica* are rather untrustworthy, while on the other hand the absence of relapses in his cases is extremely important.

FACTORS EXERTING AN INFLUENCE UPON THE RESULTS OBTAINED

Before proceeding to a discussion of our cases, it is deemed advisable to consider five factors which exert an influence upon the results obtained.

1. *Distribution of entamœbæ in stools.*—A fact well known by persons familiar with stool examination is that entamœbæ are very unequally distributed in a given specimen and in different specimens from an infected individual. For this reason it is impossible to give more than an approximate idea of the intensity of an infection and difficult to tell when a specimen is truly negative. Hence it is necessary to adopt some arbitrary standard for comparison. In this investigation a rough indication of the intensity of infection in the first specimen examined was given by using +, ++, and +++. In subsequent examinations a positive report was made as soon as it was definitely decided that entamœbæ were present and four cover-glass preparations were examined before a given specimen was said to be negative.

2. *Number of consecutive negative examinations required to ensure one of the absence of entamœbæ from the intestinal tract.*—A glance at Tables II to V will suffice to convince anyone that a single negative examination is quite insufficient to ensure one of the absence of entamœbæ from the intestinal tract. In a general way, results obtained in this investigation give some indication of the number of consecutive negatives to be required. One negative examination was followed by a subsequent examination in 72 instances. The subsequent examination was positive in 25, or 34.7 per cent, and negative in 47, or 65.3 per cent. The examination following 2 consecutive negatives was positive in 5, or 25 per cent, and negative in 15, or 75 per cent, of 20 cases. The following examination in 7 cases with 3

consecutive negative examinations was positive in 1, or 14.3 per cent, and negative in 6, or 85.7 per cent. These results indicate that more than 3 consecutive negative examinations must be secured before a case may be said to be absolutely free from entamœbæ, provided 4 cover-glass preparations be examined of each specimen.

Insufficient examinations were made in a majority of our cases; hence, for the sake of comparing the results obtained in the several series of cases the arbitrary standard of two consecutive final negative examinations obtained actually and by estimation³ (see Table VIII) is adopted. *Two consecutive negative examinations are, however, as stated above, not sufficient evidence of the absence of entamœbæ from the intestinal tract.*

3. *The personal equation.*—The personal equation entering into examinations must always be taken into consideration. It may be safely assumed that entamœbæ, although present, were not discovered in some of our examinations. All of the laboratory work was, however, performed by the same person (Willets), so that the personal factor is constant in the several groups of cases.

4. *The effect of rest and diet upon entamœbiasis.*—That rest and diet are factors which influence entamœbic dysentery is proved by the histories of patients entering hospitals with chronic entamœbic dysentery. A not uncommon history of such a patient is the recurrence of dysentery at varying intervals during a period of months or years, the individual attack having subsided in response to rest, a modified diet, and perhaps a simple purgative. Since these factors influence the clinical evidences of entamœbiasis, are they not to be reckoned with in the elimination of entamœbæ from the intestinal tract? The results obtained in our controls, which were chiefly surgical cases, and hence at rest and upon a restricted diet for a part of the period during which they were under observation, suggest an affirmative answer to this question.

5. *Spontaneous symptomatic cure of entamœbic dysentery.*—While entamœbic dysentery may be acute or chronic, it is most frequently of the chronic form, characterized by recurring dysenteric attacks. We may, therefore, expect to secure apparently good clinical results in some instances with any method of treatment. For example, among the 133 cases here considered, 29 entered the hospital with entamœbic dysentery, but 2,

³ The estimations were based on the percentage of cases that showed by actual examination two consecutive negatives.

about 7 per cent, of them cleared up clinically before medical treatment began. Accordingly, these cases were placed in our nondysenteric series.

The results obtained in our several series of cases have been placed in accompanying tables. They will need but slight comment. The laboratory findings have been given in detail in order to emphasize the importance of securing a sufficient number of negative examinations before a case is pronounced cured.

DYSENTERIC CASES

One of the dysenteric cases died. This case was treated exclusively with emetine which was administered intravenously excepting during the first day of treatment. Lesions of acute and chronic entamœbic dysentery were found at autopsy. The patient might have been saved if emetine had been administered entirely by the hypodermic method; perhaps he would have died under any form of treatment.

As shown in Table VI, emetine was much more effective in causing the disappearance of symptoms than ipecac. Of the emetine cases, 91.9 per cent recovered in an average of 3.6 days with the average administration of 0.287 gram of emetine. The corresponding figures for the ipecac cases are 62.5 per cent, 8.5 days, and 16.3 grams.

When considered from the viewpoint of expelling entamœbæ from the intestinal tract of the symptomatically cured cases, the two drugs were about equally efficacious. Two consecutive final negatives were present (by actual occurrence and by approximation) in 61.4 per cent of 10 recovered emetine cases and in 65.0 per cent of 10 recovered ipecac cases. The average number of days from the beginning of treatment to the first of the two consecutive final negatives was 8.25 in the emetine cases and 8.5 in the ipecac cases, and the average amount of the drug administered during this period was 0.484 gram of emetine and 16.67 grams of ipecac.

It may be stated that the average number of days from the beginning of treatment to the end of observation in the cases discharged positive for entamœbæ was 10.8 in emetine cases and 11.6 in ipecac cases. During this period an average of 0.667 gram of emetine and 16.0 grams of ipecac was administered. Failure to obtain negative laboratory results in these cases, therefore, was not due to observation for a lesser number of days or the administration of a lesser total amount of drug than to recover cases in either the emetine or the ipecac series.

Two of the emetine cases which were discharged while still positive for entamœbæ quickly reëntered the hospital with relapses. One of the two ipecac cases which were discharged unimproved was in the hospital a fraction less than five days. Five of the ten laboratory examinations made in the other case were negative. A culture was negative for dysentery bacilli in this case, but it is considered very probable that entamœbæ were not entirely responsible for the dysenteric symptoms.

The results obtained in our dysenteric cases are compared in Table VII with those secured by Rogers(5). It is to be noted that his results are more in favor of emetine, as contrasted with ipecac, than our own and that we secured better results than he did with ipecac.

NONDYSENTERIC CASES

By actual occurrence and by estimation, two consecutive final negative examinations were present in the several series of nondysenteric cases as follows (see Table VIII).

	Per cent.	
Control cases	11	25.0
Ipecac cases	24	70.6
Emetine cases	7	36.8
Neosalvarsan cases	8	100.0

It would appear from the foregoing that 25 per cent of the cases apparently "cured" by ipecac, emetine, and neosalvarsan would have given two consecutive final negative examinations without treatment and hence that this percentage should be subtracted from cases "cured" by medication. Two factors are to be considered at this point, however; namely, (1) the number of examinations made of control cases which were constantly positive and (2) the average number of days from the beginning of observation of controls as compared with that from the commencement of treatment of the other cases to the first of the two final negatives. Table IV shows that 11, or 61.1 per cent, of the 18 controls which were constantly positive were examined only twice. It is highly probable that some of these cases would have yielded one or more negatives if more examinations had been made of each case. Accordingly, 25+ per cent of the controls may be considered as having given two consecutive final negative examinations. The average number of days from the beginning of observation of controls as compared with that from the beginning of treatment of the other cases to the first of the two final negatives was—

	Days.
Control cases	11.3
Ipecac cases	9.6
Emetine cases	6.0
Neosalvarsan cases	1.4

It thus appears that not 25+ per cent but a lesser one should be subtracted from the results apparently obtained by the administration of ipecac, emetine, and neosalvarsan in our cases. It also appears that the percentage to be subtracted decreases as we pass from the ipecac to the emetine in the neosalvarsan cases, becoming practically nil in the last named.

The average total grams of drug given to "cured" cases up to the first of the two final negatives was—

Ipecac	15.8
Emetine	0.391
Neosalvarsan	1.24

From the foregoing it appears that neosalvarsan is the remedy of choice for treating nondysenteric entamœbiasis and that emetine is inferior to ipecac in percentage of "cures" obtained but superior to it in rapidity of action. The evidence regarding emetine and ipecac is hence rather contradictory. Perhaps the explanation of this lies in the facts that the dosage of emetine varied widely, that this drug was administered in some cases hypodermically and in others intravenously, and that the ipecac cases were treated more persistently than the emetine cases. The number of cases of the emetine series treated by hypodermic injections and of those treated by intravenous injections is too small to admit of comparison. The indications were that the hypodermic method is the better of the two in expelling entamœbæ from the intestinal tract, probably because of slower elimination. It has the disadvantage of causing a local reaction at the site of injection, however, while this symptom does not attend cases treated intravenously.

The average of days of treatment was greater but the average of total grams of drug administered was less in "uncured" cases than in those "cured" by ipecac or by emetine.

SUMMARY

1. The 132 cases of entamœbiasis considered consist of 27 dysenteric and 105 nondysenteric cases. The dysenteric cases are divided into 11 treated with emetine and 16 with ipecac; the nondysenteric, into 44 controls—34 treated with ipecac, 19 with emetine, and 8 with neosalvarsan.
2. A. Prophylaxis against the occurrence of entamœbic dysentery in an infected individual and against carriers of *Entamœba histolytica*

- consists in (1) making a differential diagnosis between *E. coli* and *E. histolytica* and treating only those infected with the latter species or (2) treating all persons indiscriminately who are infected with entamœbæ.
- B. The exclusion of *E. histolytica* from an infection is impracticable for routine usage because of (1) the experience required to make a correct differential diagnosis between *E. histolytica* and *E. coli*, (2) the time required for an experienced microscopist to make such a differential diagnosis, and (3) the frequency of *E. histolytica* in this locality.
- C. Prophylactic treatment should, therefore, be confined to expelling entamœbæ from the intestinal tract. In order that such a treatment may be widely used, it must be inexpensive, give good results quickly, and the method of administration must be simple and unattended by prolonged unpleasant reaction.
3. A. Four preparations are now in use for entamœbiasis—ipecac, emetine, neosalvarsan, and bismuth. Reports of each and all of these treatments deal chiefly with their application to the symptomatic cure of dysenteric cases, whereas they should be applied also to the cleansing of the bowel of entamœbæ.
- B. Results obtained by Winn in dysenteric, and by ourselves in nondysenteric, entamœbiasis with salvarsan and with neosalvarsan indicate that this treatment may prove to be the most efficacious of the 4 varieties in quickly relieving the dysenteric symptoms and expelling entamœbæ from the intestinal tract.
4. A. Entamœbæ are very unequally distributed in a given stool and in different stools from an infected individual. This makes it difficult to estimate the intensity of an infection and to tell when a specimen is truly negative.
- B. More than 3 consecutive negative examinations are required before one may state with safety that a person is free from entamœbæ, provided 4 cover-glass preparations be examined of each specimen.
5. Rest and diet influence the clinical evidences of entamœbic dysentery favorably, and our results in control cases tend to show that they are to be reckoned with in the elimination of entamœbæ from the intestinal tract.
6. Because of the recurrent nature of entamœbic dysentery, it is to be remembered that some apparently good clinical results will be obtained with any form of treatment.
7. A. In our dysenteric cases emetine gave a larger percentage of symptomatic cures and acted quicker in this class of cases than ipecac.
- B. Emetine and ipecac were about equally efficacious in expelling entamœbæ from the intestinal tract. The time required to expel the entamœbæ with the two preparations was also about equal.
8. In our nondysenteric cases neosalvarsan freed the bowel of entamœbæ in 100 per cent of cases, ipecac in 70.6 per cent, and emetine in 36.8 per cent. From the last two percentages an undetermined factor which is less than 25 per cent must be subtracted, because this percentage of cases would have given 2 consecutive final negative examinations (an arbitrary standard adopted for comparative purposes) in the time limits without treatment.

CONCLUSIONS

1. The determination of the relative value of ipecac, emetine, and neosalvarsan in dysenteric and nondysenteric entamœbiasis requires much further observation.

2. Our work simply paves the way for additional investigations.

LITERATURE REFERRED TO IN THE TEXT

- (1) ROGERS. *Brit. Med. Journ.* (1912), 1, 1424.
- (2) IDEM. *Ibid.* (1912), 2, 405.
- (3) IDEM. *Lancet* (1912), 2, 1062.
- (4) IDEM. *Indian Med. Gaz.* (1912), 47, 421.
- (5) IDEM. *Therap. Gaz.* (1912), III, 28, 837.
- (6) ALLAN. *Journ. Am. Med. Assoc.* (1913), 60, 664.
- (7) BAERMANN und HEINEMANN. *Münch. Med. Wochenschr.* (1913), 60, 1132, 1210.
- (8) CHAUFFARD. *Bull. et mem. Soc. Méd. Hôpit., Paris* (1913), III, 29, 753, 1235.
- (9) DESSY y MARATTA. *Sernana Médica* (1913), 20, 797.
- (10) DESTEFANO. *Ibid.* (1913), 20, 1189.
- (11) DE VERTEUIL. *Lancet* (1913), 1, 1803.
- (12) DOPTER. *Bull. et mem. Soc. Méd. Hôpit., Paris* (1913), III, 29, 686.
- (13) DUFOUR et THIERS. *Ibid.* (1913), III, 29, 827.
- (14) GAIDE et MONZELS. *Bull. Soc. path. exotique* (1913), 6, 491.
- (15) HUTCHESON. *China Med. Journ.* (1913), 27, 243.
- (16) JOB et LÉVY. *Bull. et mem. Soc. Méd. Hôpit., Paris* (1913), III, 29, 988.
- (17) LA CAVA. *Malaria e Malatt. d. Paesi Caldi* (1913), 4, 189.
- (18) LAWSON. *Brit. Med. Journ.* (1912), 2, 793.
- (19) LYONS. *Journ. Am. Med. Assoc.* (1913), 60, 1216.
- (20) MARCHOUX. *Bull. Soc. path. exotique* (1913), 6, 313.
- (21) MAXWELL. *China Med. Journ.* (1913), 27, 116.
- (22) ROUX et TRIBONBEAU. *Bull. Soc. path. exotique* (1913), 6, 424.
- (23) WALKER. *Phil. Journ. Sci., Sec. B* (1913), 8, 253.
- (24) LAVERAN. *Bull. Acad. Méd.* (1913), 69, 142.
- (25) VEDDER. *Bull. Manila Med. Soc.* (1911), 3, 48.
- (26) EHRLICH. Chemotherapie. Vortrag, gehalten in Gegenwart Sr. Majestät des Kaisers in der Hauptversammlung der Kaiser Wilhelms-Gesellschaft zur Förderung der Wissenschaften am 24. Oktober, 1912. Dahlem-Berlin.
- (27) WINN. *Proc. Canal Zone Med. Assoc.* (1912), 5, pt. 1, 7.
- (28) MILIAN. *Bull. et mem. Soc. Méd. Hôpit., Paris* (1913), III, 29, 626.
- (29) WADHAMS and HILL. *Journ. Am. Med. Assoc.* (1913), 61, 385.
- (30) DEEKS. *Ibid.* (1913), 60, 38.

TABLE I.—Cases treated with emetine reported by different authors.

No. of case.	Author.	Laboratory examination.		Treatment.		No. of case.	Author.	Laboratory examination.		Treatment.	
		Day.	Re-sult.	Day.	Amount.			Day.	Re-sult.	Day.	Amount.
1	Rogers (2)	1	—			10	Lyons (19)	1	+	1	
		3	+	3	$\frac{1}{2}$			4	—	4	$\frac{5}{8}$
				4	$\frac{1}{3}$			6		6	$\frac{1}{2}$
2	do	1	+	1	$\frac{1}{2}$	11	do	1	+	2	$\frac{5}{8}$
3	Rogers (3)	1	+	1	1			5	+	3	$\frac{5}{8}$
		2	—	2	$1\frac{1}{3}$			9	+	4	$\frac{2}{4}$
4	do	2	+	2	$1\frac{1}{2}$					12	$\frac{5}{8}$
		3	—	3	1			14	$\frac{5}{8}$		
				4	1						
5	do	1	+	1	$1\frac{1}{2}$	12	do	1	+	3	$\frac{1}{2}$
		2	+	2	2			4	$\frac{5}{8}$		
		3	—					8	$\frac{1}{2}$		
6	do	1	+	1	1			16	—	9	$\frac{5}{8}$
		2	—	2	1			24	+	10	$\frac{2}{4}$
7	do	1	+	1	1					16	$\frac{5}{8}$
		3	—	2	1			24	$\frac{5}{8}$		
				3	1			25	$\frac{5}{8}$		
8	do	1	+	1	1					29	$\frac{5}{8}$
		2	—	2	1			30	$\frac{5}{8}$		
b 9	do	none		1	1	14	do	1	+	2	$\frac{5}{8}$
				3	1			3	$\frac{2}{4}$		
				2	1			4	$\frac{5}{8}$		
b 15	do							1	—	2	$\frac{2}{4}$
								4	—	3	$\frac{5}{8}$

^a Increased to $\frac{1}{2}$ and then decreased to $\frac{1}{3}$.

^b Entamœbic dysentery at autopsy.

TABLE II.—Thirty cases treated with emetine.

No. of case.	Duration of dysentery.	Movements in 24 hours.	Laboratory examinations.		Treatment.						Result.			
			Date.	Result.	Date.	Method.	Dose.	Doses per day.	Days.	Total.	Day of symptomatic recovery.	Number of consecutive negative laboratory examinations before discharge.		
			1913.				Grams			Grams				
1	1 mo	7-14	July 8	++	July 8-12	Hypodermic.	0.065	2	5	0.650	4	2		
			July 14	-										
			July 18	-										
2	3 mos	3-5	July 8	+++	July 8-12	do	0.065	2	5	0.650	2	5		
			July 14	-										
			July 15	+										
			July 21	-										
			July 22	-										
3	10 dys	4	July 16	+	June 18-25	do	0.044	2	10	0.965	2	0		
			July 17	+										
			July 21	+	June 26-30	do	0.065	2						
			July 26	+										
			July 30	+										
			July 21	+++										
July 22	+													
4	10 dys	10-12	July 23	+	July 21-27	do	0.065	2	7	0.910	2	0		
			July 25	+										
			July 27	+										
			July 31	+										
			Aug. 20	+										
5	(?)	9-11	Aug. 28	-	Aug. 21-23	do	0.065	2	3	0.390	4	1		
			Aug. 29	+										
			Sept. 4	+										
			Sept. 7	-										
			Aug. 18	+										
6	1.5 yrs	8	Aug. 21	+	Aug. 24-26, 30 to Sept. 1.	do	0.065	2	6	0.780	5	2		
			Aug. 28	+										
			Sept. 2	-										
			Sept. 3	-										
			Aug. 21	+++										
7	2 wks	12	Aug. 26	-	Aug. 21-24	do	0.065	2	4	0.520	3	2		
			Aug. 27	-										
			Aug. 27	+										
			Sept. 2	+										
			Sept. 4	+										
			Aug. 27-30	do									0.065	2
			Sept. 7-12, 17, 18, 20, 22.	Intravenous.									0.022	2
			Sept. 12	+										
Sept. 17	+													
8	2 yrs	9-12	Sept. 21	+	23	do	0.120	2	16	1.480	*1			
			Sept. 22	+										
			Sept. 24	+										
			Sept. 25	+										
			Sept. 24	+										
			Sept. 25	+										
			Sept. 29	+										

* Died.

TABLE II.—Thirty cases treated with emetine—Continued.

No. of case.	Duration of dysentery.	Movements in 24 hours.	Laboratory examinations.		Treatment.						Result.	
			Date.	Result.	Date.	Method.	Dose.	Doses per day.		Total.	Day of symptomatic recovery.	Number of consecutive negative laboratory examinations before discharge.
							Grams			Grams		
9	5 dys	5	1913. Sept. 6 Sept. 10 Sept. 12 Sept. 16 Sept. 17 Sept. 27 Sept. 13 Sept. 16 Sept. 17 Sept. 18 Sept. 22 Sept. 23 Sept. 24 Sept. 26	+ - - - - - + + - - + + + +	Sept. 9-11	Intravenous.	0.022	2	3	0.132	8	5
10	4 mos.	4-5	Sept. 16 Sept. 17 Sept. 18 Sept. 22 Sept. 23 Sept. 24	+ + - + + +	Sept. 14, 20 Sept. 15-18, 22	do do	0.022 0.044	2 2	7	0.308	3	0
11	15 mos.	12	Oct. 3 Oct. 6 July 7 July 10 July 14 July 15 July 19 July 21 July 22 July 23	+ - + + + + - - - -	Oct. 4-5	Intravenous.	0.032	2	2	0.128	3	1
12	0	0	July 11 July 19 July 21 July 22 July 23	+ - + - -	July 11-18	do	0.065	2	8	1.240		2
13	0	0	July 11 July 19 July 21 July 23 July 14 July 21 July 22	+ - - - ++ + +	July 11-14	Hypodermic.	0.065	2	4	0.520		3
14	0	0	July 14 July 21 July 22 July 24 July 26 July 30 Aug. 2	+ + + + + + +	July 14-26	do	0.065	2	13	1.690		0
15	0	0	July 26 July 28 July 31	++ + +	July 27-30	do	0.065	2	4	0.520		0
16	0	0	July 21 July 23 July 26	+ + -	July 21 July 22 July 23	do do do	0.022 0.044 0.022	2 2 2	3	0.176		

TABLE II.—Thirty cases treated with emetine—Continued.

No. of case.	Duration of dysentery.	Movements in 24 hours.	Laboratory examinations.		Treatment.						Result.	
			Date.	Result.	Date.	Method.	Dose.	Doses per day.	Days.	Total.	Day of symptomatic recovery.	Number of consecutive negative laboratory examinations before discharge.
							Grams			Grams		
17	0	0	1913.									
			July 23	+	July 27-28	Hypodermic.	0.044	2	2	0.176	---	0
			July 30	-								
Aug. 1	+											
18	0	0	July 26	+	July 26-28	do	0.044	2	3	0.306	---	0
			Aug. 4	-								
			Aug. 14	+								
			July 29	+								
19	0	0	July 30	+	July 30-31; Aug. 1	do	0.065	2	3	0.390	---	2
			Aug. 1	-								
			Aug. 4	-								
			Aug. 4	++								
20	0	0	Aug. 19	-	Aug. 16-18	do	0.065	2	3	0.390	---	3
			Aug. 20	+								
			Aug. 22	-								
			Aug. 25	-								
			Aug. 29	-								
21	0	0	Aug. 23	+	Sept. 10-12	Intravenous.	0.022	1	3	0.066	---	0
			Sept. 9	+								
			Sept. 17	+								
			Aug. 26	+								
22	0	0	Aug. 29	+	Sept. 12-13	do	0.022	1	2	0.044	---	0
			Sept. 6	+								
			Sept. 13	+								
			Sept. 18	-								
			Sept. 19	-								
23	0	0	Sept. 26	+	Sept. 12	Intravenous.	0.022	2	1	0.044	---	1
			Sept. 4	+								
			Sept. 13	-								
			Sept. 6	+								
24	0	0	Sept. 13	-	Sept. 8-11	do	0.022	2	4	0.176	---	4
			Sept. 16	-								
			Sept. 17	-								
			Sept. 9	+								
25	0	0	Sept. 13	+	July 14, 16	do	0.022	2	2	0.088	---	4
			Sept. 16	-								
			Sept. 17	-								
			Sept. 20	-								
26	0	0	Sept. 23	-	Sept. 11, 16	do	0.022	2	2	0.088	---	0
			Sept. 11	+								
			Sept. 17	+								
27	0	0	Sept. 13	+	Sept. 18-19	do	0.022	2	2	0.088	---	0
			Sept. 20	+								

TABLE II.—Thirty cases treated with emetine—Continued.

No. of case.	Duration of dysentery.	Movements in 24 hours.	Laboratory examinations.		Treatment.						Result.					
			Date.	Result.	Date.	Method.	Dose.	Doses per day.	Days.	Total.	Day of symptomatic recovery.	Number of consecutive negative laboratory examinations before discharge.				
28	0	0	1913.		Sept. 19 -----	Hypodermic.	Grams	2	3	Grams	0.252	0				
			Sept. 15	+									Sept. 20 -----	do	0.044	2
			Sept. 30	+									Sept. 21 -----	do	0.065	2
			29	0	0	Sept. 22	++	Sept. 24-27 ...	Intravenous.	0.032	2	4	0.256	0		
Sept. 23	+															
Oct. 1	+															
Oct. 2	+															
Oct. 4	+															
Oct. 12	+															
30	0	0	Sept. 30	++	Oct. 4, 5, 6, 12.	do	0.032	2	4	0.256	0					
			Oct. 2	+												
			Oct. 7	-												
			Oct. 10	+												
			Oct. 12	+												

TABLE III.—Fifty cases treated with ipecac.

No. of case.	Duration of dysentery.	Movements in 24 hours.	Laboratory examinations.		Treatment.				Result.		
			Date.	Result.	Date.	Dose in grams.	Days.	Total.	Day of symptomatic cure.	Number of consecutive negative laboratory examinations before discharge.	
1	(?)	6-10	1912-1913.		Aug. 8, 9, 11-19	2.0	11	Grams.	22.0	12	1
			Aug. 6	+							
			Aug. 10	+							
			Aug. 16	-							
2	(?)	8-9	Aug. 14	++	Aug. 15-27	2.0	13	26.0	improved.	1	
			Aug. 21	+							
			Aug. 26	-							
3	2 yrs	6-7	Sept. 3	++	Sept. 4-10	2.0	7	14.0	5	1	
			Sept. 11	-							
4	5 mos	10	Oct. 3	+	Oct. 3-9	2.0	7	14.0	improved.	1	
			Oct. 9	-							

TABLE III.—Fifty cases treated with ipecac—Continued.

No. of case.	Duration of dysentery.	Movements in 24 hours.	Laboratory examinations.		Treatment.				Result.	
			Date.	Result.	Date.	Dose in grams.	Days.	Total.	Day of symptomatic cure.	Number of consecutive negative laboratory examinations before discharge.
			1912-1913.					Grams.		
5.	1 yr.	6	Oct. 8	+	Oct. 8-16.....	2.0	9	18.0	9	1
			Oct. 11	+						
			Oct. 15	-						
			Oct. 24	+						
6	5 mos.	8-10	Nov. 26	+	Nov. 27-Dec. 2.	2.0	6	12.0	unimproved.	2
			Dec. 6	-						
			Dec. 20	++	Dec. 20-Jan. 2, 5-9	2.0	19	38.0	improved.	1
7	2 mos.	7-10	Dec. 27	+						
			Jan. 1	-						
			Jan. 4	+						
			Jan. 8	-						
			Jan. 27	+++	Jan. 28-Feb. 8, 21-26	3.0	18	54.0	16	8
8	1 yr.	8-10	Feb. 1	-						
			Feb. 3	+						
			Feb. 6	-						
			Feb. 7	-						
			Feb. 9	-						
			Feb. 16	-						
			Feb. 22	-						
			Feb. 27	-						
			Mar. 2	-						
			Mar. 10	-						
			Feb. 7	++	Feb. 8-13.....	2.0	6	12.0	improved.	2
9	9 dys.	4-5	Feb. 8	+						
			Feb. 13	-						
			Feb. 17	-						
			Feb. 24	+	Feb. 26-Mar. 4.	2.0	7	14.0	5	1
10	1 dy.	11	Mar. 1	+						
			Mar. 5	-						
			Mar. 8	+	Mar. 9-15.....	0.6	7	4.2	3	2
11	4 mos.	4	Mar. 13	-						
			Mar. 27	-						
			Mar. 18	+	Mar. 18-27.....	0.3	10	3.0	10	2
12	2 dys.	3	Mar. 24	+						
			Mar. 26	-						
			Mar. 28	-						
			Mar. 21	++	Mar. 22-27, Apr. 1-5	2.0	11	22.0	9	1
13	1 wk.	4-5	Mar. 23	+						
			Apr. 6	-						

TABLE III.—Fifty cases treated with ipecac—Continued.

No. of case.	Duration of dysentery.	Movements in 24 hours.	Laboratory examinations.		Treatment.			Result.		
			Date.	Result.	Date.	Dose in grams.	Days.	Total.	Day of symptomatic cure.	Number of consecutive negative laboratory examinations before discharge.
			1912-1913.					Grams.		
14	(?)	6	Mar. 26	+	Mar. 28-Apr. 2, 11-19	2.0	15	30.0	unimproved.	2
			Mar. 27	-						
			Mar. 29	-						
			Mar. 31	-						
			Apr. 3	+						
			Apr. 4	+						
			Apr. 9	+						
			Apr. 13	+						
			Apr. 16	-						
			Apr. 17	-						
15	3 wks	2	Apr. 18	+	Apr. 18-26	2.0	9	18.0	5	1
			Apr. 19	+++						
			Apr. 24	-						
16	(?)	3-4	Apr. 28	+	Apr. 28-May 2	2.0	5	10.0	7	2
			May 3	-						
			May 4	-						
17	0	0	Sept. 10	+	Sept. 11-16	2.0	6	12.0	-----	2
			Sept. 12	-						
			Sept. 19	-						
			Sept. 24	+						
18	0	0	Sept. 26	+	Apr. 25-30, Oct. 9-14.	2.0	12	24.0	-----	1
			Oct. 3	-						
			Oct. 8	+++						
19	0	0	Oct. 14	-	Oct. 8-10	2.0	8	16.0	-----	1
			Oct. 3	+						
20	0	0	Oct. 10	-	Oct. 12-15	2.0	4	8.0	-----	1
			Oct. 11	+						
21	0	0	Oct. 15	-	Nov. 6-20	2.0	15	30.0	-----	1
			Nov. 6	+						
22	0	0	Nov. 21	-	Nov. 14-21	3.0	8	24.0	-----	1
			Nov. 14	+						
23	0	0	Nov. 21	-	Nov. 16-26	3.0	10	30.0	-----	2
			Nov. 16	+						
			Nov. 19	+						
			Nov. 23	+						
24	0	0	Nov. 27	-	Nov. 20-22	3.0	3	9.0	-----	1
			Nov. 29	-						
25	0	0	Nov. 20	+	Nov. 27-Dec. 3	2.0	7	14.0	-----	1
			Nov. 23	-						
			Nov. 26	+						
			Dec. 3	-						

TABLE III.—Fifty cases treated with ipecac—Continued.

No. of case.	Duration of dysentery.	Movements in 24 hours.	Laboratory examinations.		Treatment.				Result.	
			Date.	Result.	Date.	Dose in grams.	Days.	Total.	Day of symptomatic cure.	Number of consecutive negative laboratory examinations before discharge.
			1912-1913.					Grams.		
26	0	0	Feb. 5	+	Feb. 7, 8, 10, 11, 13, 15, 16.	3.0	7	21.0	-----	0
			Feb. 11	+						
			Feb. 16	+						
			Feb. 20	+						
27	0	0	Feb. 6	++	Feb. 6, 7, 18, 21, 24, 28.	2.0	9	18.0	-----	0
			Feb. 21	++						
			Feb. 25	+						
			Feb. 28	+						
28	0	0	Mar. 11	+	Mar. 20-28	2.0	9	18.0	-----	0
			Mar. 19	+						
			Apr. 1	+						
			Apr. 4	+						
29	0		Apr. 1	+++	Apr. 2-11	2.0	10	20.0	-----	3
			Apr. 8	+++						
			Apr. 12	-						
			Apr. 16	-						
30	0	0	Apr. 2	+	Apr. 4, 6-22	2.0	18	36.0	-----	2
			Apr. 9	+						
			Apr. 14	+						
			Apr. 23	-						
31	0	0	May 5	-	Apr. 12-15, 18-20.	2.0	7	14.0	-----	1
			Apr. 9	+						
			Apr. 11	+++						
			Apr. 15	+						
32	0	0	Apr. 21	-	Apr. 14-19	2.0	6	12.0	-----	0
			Apr. 11	+						
			Apr. 14	+						
			Apr. 16	-						
33	0	0	Apr. 17	-	Apr. 16-22, 25	2.0	8	16.0	-----	1
			Apr. 21	+						
			Apr. 15	+						
			Apr. 21	+						
34	0	0	Apr. 21	+	Apr. 20-26, May 2-6, 12-16	2.0	17	34.0	-----	1
			Apr. 25	-						
			Apr. 19	+						
			Apr. 21	+						
			Apr. 25	-						
			May 7	-						
			May 11	+						
			May 17	-						

TABLE III.—Fifty cases treated with ipecac—Continued.

No. of case.	Duration of dysentery.	Movements in 24 hours.	Laboratory examinations.		Treatment.			Result.		
			Date.	Result.	Date.	Dose in grams.	Days.	Total.	Day of symptomatic cure.	Number of consecutive negative laboratory examinations before discharge.
			1912-1913.					Grams.		
35	0	0	Apr. 22	+	Apr. 22, 23, 29, 30, May 6-8.	2.0	8	16.0	-----	3
			Apr. 24	+						
			Apr. 28	+						
			May 5	+						
			May 10	-						
			May 12	-						
36	0	0	Apr. 25	++	Apr. 28-May 11.	2.0	14	28.0	-----	1
			May 12	--						
			Apr. 28	+						
37	0	0	May 1	+	Apr. 28-May 4.	2.0	7	14.0	-----	2
			May 5	-						
			May 9	-						
38	0	0	Apr. 28	+	Apr. 29, 30, May 4-7.	2.0	6	12.0	-----	2
			Apr. 30	-						
			May 3	+						
			May 8	-						
39	0	0	May 4	+	May 2-6.....	2.0	5	10.0	-----	1
			May 7	-						
40	0	0	May 4	++	May 5-9.....	2.0	5	10.0	-----	2
			May 5	+						
			May 10	-						
			May 16	-						
41	0	0	May 6	++	May 10-13.....	2.0	4	8.0	-----	2
			May 10	+++						
			May 14	-						
42	0	0	May 15	-	May 11-14.....	2.0	4	8.0	-----	1
			May 10	+						
43	0	0	May 15	-	May 17-20.....	2.0	4	8.0	-----	2
			May 13	+						
			May 16	+						
			May 20	-						
			May 22	-						
44	0	0	May 18	+	May 22-26.....	2.0	5	10.0	-----	2
			May 21	+						
			May 26	-						
			May 29	-						
45	0	0	May 31	+	June 3-11.....	2.0	9	18.0	-----	1
			June 12	-						
46	0	0	June 4	++	June 6-10.....	3.0	5	15.0	-----	1
			June 9	+						
			June 11	-						

TABLE III.—Fifty cases treated with ipecac—Continued.

No. of case.	Duration of dysentery.	Movements in 24 hours.	Laboratory examinations.		Treatment.				Result.	
			Date.	Result.	Date.	Dose in grams.	Days.	Total.	Day of symptomatic cure.	Number of consecutive negative laboratory examinations before discharge.
			1912-1913.					Grams.		
47	0	0	Aug. 18	+	Aug. 21-22	4.0	2	8.0	-----	0
			Aug. 22	+						
			Aug. 26	+						
48	0	0	Sept. 1	-	Aug. 26-29	2.0	4	8.0	-----	2
			Sept. 5	-						
			Sept. 6	++						
49	0	0	Sept. 13	-	Sept. 11-13	2.0	4	8.0	-----	0
			Sept. 15	+						
			Sept. 21	++						
50	0	0	Sept. 25	-	Sept. 21-23	2.0	2	4.0	-----	1

TABLE IV.—Control cases.

No. of case.	Laboratory examinations.		Number of consecutive negative laboratory examinations before discharge.	No. of case.	Laboratory examinations.		Number of consecutive negative laboratory examinations before discharge.
	Date.	Result.			Date.	Result.	
1.	Jan. 31	+	1	8.	July 28	+	0
	Feb. 8	-			Aug. 4	+	
	Apr. 3	+			Aug. 2	+	
2.	Apr. 4	+	1	9.	Sept. 7	+	0
	Apr. 8	-			July 30	+	
3.	July 4	+	1	10.	Aug. 12	+	0
	July 5	+			Aug. 17	+	
	July 18	-			Aug. 19	+	
	July 12	+			Aug. 5	++	
4.	Aug. 8	-	0	11.	Aug. 7	-	0
	Aug. 14	-			Sept. 4	+	
	Aug. 18	+			Aug. 5	+	
	Aug. 19	-			Aug. 20	-	
5.	Aug. 26	+	0	12.	Aug. 27	-	2
	July 15	+			Aug. 6	+	
	July 21	-			Aug. 9	+	
6.	July 22	+	0	13.	Aug. 14	+	0
	July 25	+			Aug. 19	+	
	July 15	+			Aug. 8	+	
7.	July 26	+	0	14.	Aug. 15	+	0
	July 24	++			Aug. 8	+	
	July 26	-			Aug. 15	+	
	July 30	+	0	15.	Aug. 8	-	1

TABLE IV.—Control cases—Continued.

No. of case.	Laboratory examinations.		Number of consecutive negative laboratory examinations before discharge.	No. of case.	Laboratory examinations.		Number of consecutive negative laboratory examinations before discharge.
	Date.	Result.			Date.	Result.	
16.	Aug. 12	+	0	28.	Aug. 27	+	2
	Aug. 22	-			Sept. 16	-	
17.	Aug. 25	+	1	29.	Sept. 23	-	1
	Aug. 12	+			Aug. 29	+	
18.	Aug. 25	-	0	30.	Sept. 4	-	0
	Aug. 18	+			Sept. 2	+	
	Aug. 27	+		31.	Sept. 4	+	0
	Aug. 28	-			Sept. 3	+	
19.	Sept. 2	+	0	32.	Sept. 5	+	2
	Sept. 9	+			Sept. 4	+	
	Sept. 19	+		33.	Sept. 12	-	1
	Aug. 19	+			Sept. 17	-	
	Aug. 29	+			Sept. 5	+	
20.	Sept. 3	+ +	0	34.	Sept. 13	-	0
	Sept. 11	+			Sept. 5	+	
	Sept. 19	+			Sept. 19	-	
21.	Aug. 20	+	0	35.	Sept. 22	+	1
	Aug. 27	+			Sept. 5	+	
22.	Aug. 21	+	1	36.	Sept. 22	-	0
	Aug. 27	-			Sept. 10	+	
23.	Aug. 22	+	0	37.	Sept. 17	+	2
	Sept. 26	+			Sept. 22	+	
	Aug. 23	+			Sept. 27	+	
24.	Aug. 27	-	2	38.	Sept. 12	+	0
	Sept. 6	-			Sept. 18	-	
	Aug. 25	+			Sept. 20	-	
	Sept. 2	+			Sept. 13	+	
25.	Sept. 7	+	0	39.	Sept. 26	+	0
	Sept. 11	+			Sept. 13	+	
	Sept. 18	+			Sept. 29	-	
26.	Aug. 26	+	1	40.	Sept. 30	+	2
	Aug. 30	-			Sept. 16	+	
	Sept. 13	+			Sept. 19	-	
27.	Sept. 22	-	0	41.	Sept. 22	-	0
	Aug. 26	+			Sept. 17	+	
	Sept. 5	-			Sept. 22	+	
	Sept. 11	+			Sept. 30	+	
	Sept. 17	+ +			42.	Sept. 24	
Aug. 26	+	Oct. 2	+				
27.	Aug. 28	+ +	0	43.	Sept. 20	+	3
	Sept. 3	+ +			Oct. 8	-	
	Sept. 9	+			Oct. 12	-	
	Sept. 10	+			Oct. 15	-	
	Sept. 17	+			44.	Sept. 30	
Sept. 26	+	Oct. 14	+				

TABLE V.—Cases treated with neosalvarsan.

(Dose 0.9 gram.)

No. of case.	Laboratory examinations.		Treat-ment	Number of consecutive negative laboratory examinations before discharge.	No. of case.	Laboratory examinations.		Treat-ment.	Number of consecutive negative laboratory examinations before discharge.
	Date.	Result.				Date.	Result.		
1-----	1913.		Jan. 5 -- } Jan. 9 -- }	1	5-----	1913.		Sept. 2.. } Sept. 11. }	3
	Jan. 4	+				Aug. 26	+		
	Jan. 9	—				Sept. 5	—		
	May 3	—				Sept. 10	—		
2-----	May 5	—	May 3 --	1	6-----	Sept. 24	—	Sept. 7..	5
	Aug. 3	+ +	Aug. 9.. } Aug. 24. }	7		Sept. 1	+		
3-----	Aug. 4	+ +			Sept. 11. }	7	Sept. 13	—	Sept. 3..
	Aug. 22	—	Sept. 15	—					
	Aug. 27	—	Sept. 16	—					
	Sept. 1	—	Sept. 17	—					
	Sept. 5	—	Sept. 23	—					
	Sept. 10	—	Sept. 3	+					
	Sept. 17	—	Sept. 18	—					
4-----	Sept. 23	—	Sept. 1 -- } Sept. 8 -- }	2	7-----	Sept. 24	—	Sept. 7.. } Sept. 10. }	2
	Aug. 23	+				Sept. 26	—		
	Sept. 6	+				Sept. 3	+		
	Sept. 10	—				Sept. 6	+		
	Sept. 12	—			8-----	Sept. 16	+		
						Sept. 23	—		
						Sept. 29	—		

TABLE VI.—Comparison of results of treatment in dysenteric cases.

Cases.	Treated with ipecac.		Treated with emetine.	
	Number.	Per cent.	Number.	Per cent.
Died			1.000	9.1
Recovered symptomatically	10.00	62.5	10.000	91.9
Improved symptomatically	4.00	25.0		
Unimproved symptomatically	2.00	12.5		
Discharged:				
Negative microscopically	15.00	93.8	7.000	63.6
Positive microscopically	1.00	6.2	4.000	36.4
With two consecutive negatives *		61.4		65.0
Average days for symptomatic recovery after treatment began.	8.10		3.600	
Average days to first of two final negatives	8.50		8.250	
Average grams of drug required for symptomatic recovery.	16.30		0.287	
Average grams of drug to first of two final negatives	16.67		0.484	

* By actual examination and by estimation, see Table VIII.

TABLE VII.—Comparison of results of treatment in dysenteric cases with those obtained by Rogers (5).

Drug and authority.	Died of—				Discharged symptomatically—			
	Dysentery.			Other diseases.	Not cured.		Cured.	
	Within 3 days.	After 3 days.			Number.	Per cent.	Number. ^a	Per cent.
		Number.	Per cent.					
Ipecac:								
Rogers	4	7	26.9		6	23.1	13	50.0
Ourselves					6	37.5	10	62.5
Emetine:								
Rogers	2			2			21	100.0
Ourselves		1	9.1				10	91.9

^a Exclusive of those who died within three days and of diseases other than dysentery.

Average number of days from beginning of treatment to symptomatic recovery:

	Ipecac.	Emetine.
Rogers	11.4	2.35
Ourselves	8.1	3.60

Average grams of drug given during this period:

	Ipecac.	Emetine.
Rogers	27.1	0.130
Ourselves	^a 16.3	0.287

^a Exclusive of amount given to 2 children.

TABLE VIII.—Comparison of results in nondysenteric cases.

Laboratory findings and estimations.	Controls.		Ipecac.		Emetine.				Neosalvarsan.			
	Number.	Per cent.	Number.	Per cent.	General.		Hypodermic injection.		Intravenous injection.			
					Number.	Per cent.	Number.	Per cent.	Number.	Per cent.	Number.	Per cent.
Constantly positive	18.0	40.9	4.0	11.8	7.000	36.8	4.000	36.4	3.000	37.5	8.00	100
Giving one negative.....	26.0	59.1	30.0	88.2	12.000	63.2	7.000	63.6	5.000	62.5	8.00	100
Of these, further examination was made in The examination was:	17.0		17.0		10.000		6.000		4.000		6.00	
Negative in	7.0	41.2	13.0	76.5	6.000	60.0	3.000	50.0	3.000	75.0	6.00	100
Positive in	10.0	58.8	4.0	23.5	4.000	40.0	3.000	60.0	1.000	25.0		
Positive at final examination.....	27.0	61.4	5.0	17.6	11.000	57.9	6.000	55.5	5.000	62.6		
Negative at final examination.....	17.0	38.6	28.0	82.4	8.000	42.1	5.000	44.5	3.000	37.5	8.00	100
Of these, there were:												
Two or more final negatives in	7.0		12.0		6.000		4.000		2.000		6.00	
One final negative in	10.0		16.0		2.000		1.000		1.000		2.00	
If these had been examined further, a second negative would have been found in												
Expressed in cases	4.0	41.2	12.0	76.5		60.0		50.0		75.0		100
Thus there were two final negatives in	11.0	25.0	24.0	70.6	1.250	37.9	0.500	40.9	0.750	34.4	2.00	100
Average days from beginning of treat- ment:												
To first of two final negatives	11.3		9.6		6.000		7.500		3.700		1.40	
To end of observation in those dis- charged positive.....	17.7		10.9		10.300		10.300		10.300		1.24	
Average grams of drug given:												
To first of two final negatives			15.8		0.391		0.543		0.088		1.24	
To end of observation in those dis- charged positive.....			14.6		0.313		0.571		* 0.126			



NERVE DEGENERATION IN FOWLS FED ON UNHUSKED RICE (PALAY)

By R. B. GIBSON and ISABELO CONCEPCION

(From the Laboratory of Physiology, College of Medicine and Surgery,
University of the Philippines)

One plate

The observations of Fletcher¹ and of Fraser and Stanton² have shown that diets consisting chiefly of polished rice are the common cause of beriberi in the Orient. If the white rice, however, be replaced by the unmilled variety, the disease does not develop. Substitution of rough rice for the polished article and additions to the dietaries of the public institutions of the Philippine Islands and of the Philippine Scouts are stated to have eliminated beriberi from these organizations.³

It is generally believed, then, that among rice-eating Orientals, beriberi is due to the use of rice which has been deprived of its cortex.

Further confirmation of this idea is obtained by the discovery that rice polishings or extracts of these, when fed with the milled grain, will protect against polyneuritis in fowls.⁴ The isolation of certain "vitamines" from rice polishings and yeast are reported in the studies by Funk,⁵ by Suzuki, Shimamura, and Odaki,⁶ by Edie, Evans, Moore, Simpson, and Webster,⁷ and by Vedder and Williams.⁸ These substances, extracted in relatively minute amounts from large quantities of material, have a prompt curative effect in fowls with polyneuritis. This evidence indicates that beriberi is due to the lack of the polished rice in accessory substances which play a rôle of extreme importance in normal nutrition.

¹ *Lancet* (1907), 1, 1776.

² *Lancet* (1909), 1, 451; Studies from Institute for Medical Research. Federated Malay States (1909), No. 10.

³ Heiser, *This Journal, Sec. B* (1911), 6, 229; Chamberlain, *ibid.* (1911), 6, 133.

⁴ Schaumann, *Beih. z. Arch. f. Schiffs- und Trop.-Hyg.* (1910), 14, 325; Fraser and Stanton, Studies from Institute for Medical Research. Federated Malay States (1911), No. 12; Chamberlain and Vedder, *This Journal, Sec. B* (1911), 6, 251; Chamberlain, Vedder, and Williams, *ibid.* (1912), 7, 39.

⁵ *Journ. Physiol.* (1913), 46, 173, and earlier papers.

⁶ *Biochem. Zeitschr.* (1912), 43, 89.

⁷ *Biochem. Journ.* (1912), 6, 234.

⁸ *This Journal, Sec. B* (1913), 8, 175.

There is, however, evidence to show that the use of unpolished rice will not absolutely prevent beriberi in man. Thus Strong and Crowell,⁹ in reporting their experiments on Bilibid prisoners, say:

In Group III, where the diet consisted largely of red rice, only 1 (No. 13) of the 6 developed rather marked symptoms of beriberi, while 1 (No. 18) developed only slight cardiac symptoms. In Nos. 14, 15, 16, and 17 no symptoms at all of the disease developed. In No. 13 the most striking symptoms suggestive of beriberi were pain and tenderness in the epigastrium, symptoms suggesting paræsthesia, epigastric pulsation, cardiac disturbances and dyspnoea, and marked diminution and almost disappearance of the knee jerks, so that it was very difficult or impossible at times to elicit them. The condition of this individual, at the time that his diet was changed, certainly led one to believe that had the diet been persisted with, a well-marked case of beriberi would have developed.

Again Shibayama¹⁰ states:

Experiments * * * were carried out in coal mines where the miners had been yearly affected most severely and in a fishing village where the inhabitants had also suffered severely. In both places the inhabitants were divided into groups consisting of a certain number of persons (usually 100); during the beriberi season (seven months from the beginning of April to the end of October) one group was provided with cured rice,¹¹ another with the mixed diet consisting of rice and barley, while a third was given white rice as a control, the object being to determine which group provided the largest number of patients. * * * The experiment was carried out twice in each place, and showed that neither the cured rice nor the mixed diet of rice and barley is able absolutely to prevent the disease, though they seem to play some part.

While considerable success has obtained in the treatment of infantile beriberi with rice polishings or with extracts of the bran,¹² cases in adult patients are apparently more resistant. Vedder and Williams¹³ report 3 adult cases, and they believe that the administration of their preparation of extract of the rice polishings—

is capable of dissipating the dropsy in cases of wet beriberi and of promptly relieving the attacks of cardiac insufficiency, but that this extract is incapable of curing the paralysis in cases of so-called dry beriberi.

⁹ *This Journal, Sec. B* (1912), 7, 404.

¹⁰ *Journ. Trop. Med. & Hyg.* (1913), 16, 284.

¹¹ "Before the exact origin and method of preparing rice capable of causing beriberi was known, it was termed 'uncured,' while that which did not produce the disease was called 'cured' rice." [Aron, *This Journal, Sec. B* (1910), 5, 82.] Evidently red or unpolished rice is meant in this case. [Footnote 11 is ours.—R. B. G.]

¹² Gabriel, *Revista Filipina* (1911), 2, 441; Chamberlain and Vedder, *Bull. Manila Med. Soc.* (1912), 4, 26.

¹³ *This Journal, Sec. B* (1913), 8, 175.

They believe that Funk's base, administered in 2 doses each prepared from 10 kilograms of rice polishings, "greatly relieved, if not cured" the paralysis in one case. These investigators believe that the large amount of material necessary to yield any appreciable amount of the protective substances is due to the fact that there is considerable loss in the chemical manipulation in the course of isolation. We understand that the treatment of beriberi cases in the Philippine General Hospital with rice polishings or preparations of the rice bran is not followed by the uniformly satisfactory results which should be expected from the theoretical view of the etiology of beriberi.

From the evidence presented, then, there are cases in which beriberi apparently has developed, even though unpolished rice is the chief constituent of the dietary. Furthermore, the therapeutic use of the rice bran or extracts and preparations of this has not given the specific results for man which we have expected from theoretical considerations of the etiology of the disease, although the mortality has been greatly reduced.¹⁴ It seems to us that the facts can only be interpreted in one way. *The unpolished rice, per se, affords only partial protection against beriberi.* In other words, the rough rice does not contain in the cortex the protective substance in sufficient amounts to prevent the development of beriberi in the more susceptible individuals. Experimental evidence for this conclusion is given in the following experiment.

Six fowls were fed on palay, 3 for two months, 2 for three months, and 1 for four months. They developed no symptoms of neuritis. The sciatic nerves, when stained by the Marchi method, however, show distinct degenerative changes in every case. The results are summed up in Table I.

TABLE I.—*Fowls fed on palay.*

No.	Period.	Degeneration.
	<i>Months.</i>	
1 (31)	2	+++ Fairly pronounced.
2 (32)	2	+ Mild type; distinct lineation of myelin with few degenerated areas.
3 (33)	2	++ Distinct degeneration.
4 (30)	3	++++ Very pronounced degeneration.
5 (34)	3	++++ Very pronounced degeneration.
6 (29)	4	++ Distinct degeneration.

¹⁴ Braddon, *Journ. Trop. Med. & Hyg.* (1913), 18, 282.

Clark¹⁵ has shown that degeneration may be noticed within seven days on a polished rice diet in fowls. Such degeneration is, however, only very slight. The pictures of the sciatics in our palay-fed fowls correspond to that obtained from those fed for two weeks or more on milled rice. The degeneration in fowls 4 and 5, in fact, is more pronounced than can be observed in some fowls which have died of rice polyneuritis.

It would seem, then, that the substitution of rough rice for the polished article cannot be completely protective against beriberi in all individuals. We do not mean to say that this substitution has not practically eliminated beriberi where it has been undertaken or that the use of rice polishings is not without great therapeutic value. But in view of the accumulated evidence, we can say that the addition of other foodstuffs to a diet of unpolished rice is essential to meet the normal nutritive requirements of the body.

¹⁵ Vedder and Clark, *This Journal*, *Sec. B* (1912), 7, 423.

ILLUSTRATIONS

PLATE I

- FIG. 1. Fibers from the sciatic nerve of fowl 30 fed on palay for three months.
2. Fibers from the sciatic nerve of fowl 31 fed on palay for two months.

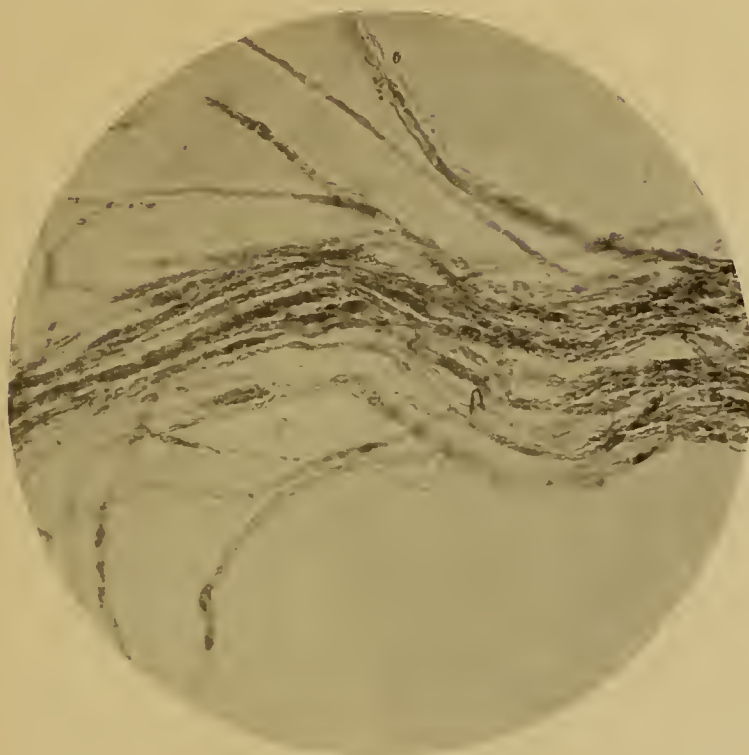

Fig. 1. Fibers from the sciatic nerve of fowl 30 fed on palay for three months.

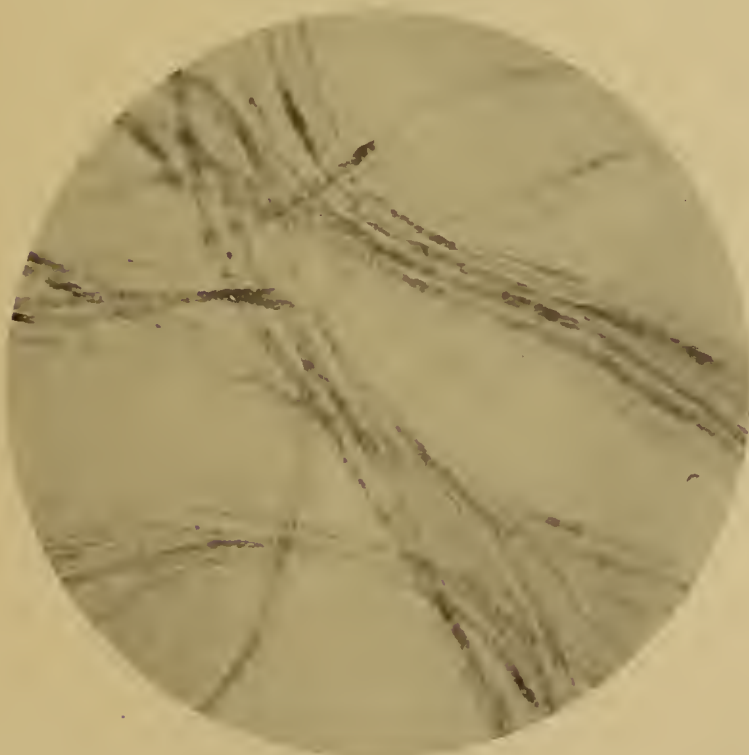

Fig. 2. Fibers from the sciatic nerve of fowl 31 fed on palay for two months.

PLATE I.

SIMULTANEOUS METHOD OF INOCULATING CATTLE AND
CARABAOS WITH SERUM FROM ANIMALS THAT
HAVE BEEN RECENTLY IMMUNIZED

By ARCHIBALD R. WARD and FREDERICK WILLAN WOOD

(From the Veterinary Division, Bureau of Agriculture, Manila, P. I.)

Three plates

The earlier literature concerning antirinderpest serum contains frequent references to the idea of increasing the protective power of the serum by successive injections of virulent blood into the animal producing the serum. The idea is emphasized that the serum of such hyperimmunized animals is preferable to the serum from animals that have merely been immunized naturally or artificially.

Braddon(1) states that in South Africa the method of injecting uninfected animals with defibrinated blood of animals which had recently recovered from pest, as a preventive method, was abandoned in favor of Turner's method of using serum from animals that had received successive and increasing doses of virus.

Turner(2) states that in the Transvaal and Natal an immune animal was injected with 100 cubic centimeters of virulent blood, and after all reaction had ceased it was bled. This blood, when defibrinated, was injected into a susceptible animal which was smeared on the muzzle with virulent material and placed with animals suffering with rinderpest. This method of simultaneous inoculation, using blood prepared at the time, seems to have been abandoned in favor of one employing a serum requiring more elaborate preparation.

Since the use of serum from hyperimmunized animals came into general use in simultaneous inoculation, Gibson(3) is the first writer known to us, who has questioned the necessity of hyperimmunizing serum-producing animals.

Shealy(4) makes a similar observation to the effect that the results obtained with the serum prepared from animals after recovery from an attack were found to be just as good as when the animal was not bled until it had been hyperimmunized.

Subsequent to the completion of the field work described

herein, there has come to notice the work of Holmes(5) which gives additional information regarding the overestimation of value of serum from hyperimmunized animals. He concludes that the serum obtained after natural recovery or after an immunizing reaction is little inferior in potency to that taken after the process of hyperimmunization.

Holmes further points out that satisfactory virulent blood may be obtained from an animal suffering a modified attack due to the injection of serum. Thus, the animals producing virulent blood recover, where formerly they were sacrificed.

The work of the present writers was undertaken with a view of reducing the cost of serum to a point that would warrant more extensive use of simultaneous inoculation. The serum formerly produced by the Bureau of Agriculture cost, delivered in the field, 24 pesos¹ per liter. That this is not excessive is shown by the fact that in the Transvaal the cost was 25 pesos per liter. Small quantities purchased by the Bureau of Agriculture from the Pasteur Institute at Nha-Trang, French Indo-China and from the Experiment Station for Animal Diseases, Tokyo, Japan, were charged for at the rate of 47.89 pesos and 34.40 pesos per liter, respectively. With serum costing 24 pesos per liter and with the doses employed by us, the expense in simultaneous inoculation for the one item of serum would slightly exceed 8 pesos per animal.

In deciding to try the use of serum from animals that had just been immunized instead of employing expensive serum from the so-called hyperimmunized animals, we were guided by several considerations. One of us, when superintendent of the serum laboratory of the Bureau of Agriculture, carrying on the routine work there of immunizing susceptible animals for serum production, employed serum in several cases from animals that had recently reacted. The results were as satisfactory as if hyperimmune serum had been employed. Further, previous experience(6) had shown that the severity of the immunizing reaction could be controlled by the amount of serum employed. Thus, if the serum drawn in the field proved to be appreciably low in protective power, the fault could readily be corrected.

The work was inaugurated in Ilocos Norte Province on carabaos belonging to the Calamba Sugar Estate, and intended for shipment to their estate at Calamba, Laguna. When the immunization was begun, there was available a supply of serum from hyperimmunized animals only sufficient for the first three

¹ One peso Philippine currency equals 50 cents United States currency.

lots of carabaos as indicated in Table I. All animals immunized subsequently to these received serum drawn in the field.

The animals while undergoing immunization were confined in large sheds erected by the owners of the carabaos, who likewise fed and cared for the animals during the twenty-five days required for immunizing.

Each animal to be immunized, while being injected, was confined in stocks made of bamboo. It received a hypodermic injection of the dose of antirinderpest serum which had been decided upon as sufficient. This standard dose was administered uniformly without reference to the size of the animals.

In the case of the carabaos belonging to lots 1, 2, 3, and 4 shown in Table I on page 127, it will be noted that gradually increasing doses were employed until there were obtained results thoroughly satisfactory in regard to death rate and severity of reaction. In determining the dose, it was considered advisable to use an amount of serum necessary for the most susceptible animal likely to be encountered, for there exist no means for predicting susceptibility. After the immunization work was under way, the virulent blood was invariably obtained from an animal undergoing immunization at a stage corresponding to the third day of febrile temperature. Thus, there was no expense for susceptible cattle for maintaining a strain of virulent blood, and no trouble of finding natural cases of rinderpest in the vicinity was necessitated.

In all cases, before virulent blood was employed, it was examined microscopically for the presence of the trypanosomes of surra in fresh and stained preparations.

One hundred ninety-six of the 429 animals in Table I, which showed no febrile reaction, were reinjected with 10 cubic centimeters of citrated virulent blood. This was done in case that the original virulent blood had been inactive when employed or some accident had prevented its introduction. Up to date, only three distinct reactions from such injection have been observed.

In the preparation of serum in the field, between 2 and 3 liters of blood were drawn from the jugular vein of all recovered animals without reference to whether or not they had reacted to the virulent blood. In a previous(6) paper it has been shown that serum from reactors is somewhat more potent, but with the dose employed this feature was not of sufficient value to warrant exempting nonreactors from the bleeding.

No blood was drawn from very old or very young, nor from pregnant animals. These exceptions reduced the number bled

to 72 per cent of the animals immunized. An average of 2.8 liters of blood per animal was drawn from 305 animals.

The technique employed in drawing blood for serum production varied in no essential particular from general practice. An autoclave heated by a gasoline torch was employed for sterilizing the instruments and bleeding flasks. No abscess formation has followed the bleeding. Large hæmatomata form occasionally, but are soon resorbed.

Blood was allowed to stand in the bleeding flasks immersed in running water in the bed of a shallow stream for from twenty-four to thirty-six hours, after which the serum was decanted into a large graduated vessel and 0.5 per cent of carbolic acid or formalin was added as preservative. The serum was then stored in 15-liter demijohns tightly corked. Serum prepared in this way has kept well for several weeks. The only trouble encountered was due to the fact that serum sometimes assumed a gelatinous form upon standing.

The serum thus prepared was ready for use, there being omitted the expensive operations of centrifugalization, filtration, and rebottling. There is nothing connected with the preparation of serum under field conditions which requires an expensive permanent plant. Experience has shown that the essential asepsis can be readily attained in a temporary structure made of grass and bamboo.

It should be noted that no ice was available for refrigeration. The necessity of holding serum for a long period was obviated by preparing it with reference to the time that it would be needed.

The results obtained during the immunization of the carabaos at Laoag are shown in Table I. In compiling the data regarding reactions, there has been adopted as a standard of minimum rise of temperature to be counted as a reaction a rise to 39° C. on two successive days, occurring between three and twelve days after inoculation. This standard is wholly arbitrary and somewhat unsatisfactory when applied to cases closely approaching it; however, none more generally useful is known. In the case of the animals in question, the dose employed was such and the average resistance of the animals of such a degree that elevation of temperature does not figure prominently. Other symptoms of rinderpest such as diarrhœa and inflammation of the conjunctivæ occurred, but this occurrence was not uniformly recorded on the temperature charts.

TABLE I.—*Record of immunization at Laoag of carabaos belonging to the Calamba Sugar Estate.*

Lot No.	Number injected.	Date of injection.	Serum per head.	Febrile reactions.		Number released.	Loss after injection.	
				No.	Per cent.		No.	Per cent.
1.....	8	July 28	c. c. 200	4	50.0	6	2	25.0
2.....	70	Aug. 11	300	28	40.0	70	0	0
3.....	63	Aug. 23	300	48	76.0	60	3	4.7
4.....	65	Aug. 28	350	43	66.0	65	0	0
5.....	27	Sept. 8	350	15	56.0	27	0	0
6.....	15	Sept. 12	350	13	86.0	15	0	0
7.....	10	Sept. 15	350	2	20.0	10	0	0
8.....	26	Sept. 24	350	4	15.0	26	0	0
9.....	31	Sept. 26	350	6	19.0	31	0	0
10.....	51	Oct. 3	350	22	43.0	51	0	0
11.....	63	Oct. 9	350	42	66.0	62	1	1.5
Total.....	429			227	52.9	423	6	1.4

It will be observed that all of the deaths, except one, occurred in the first three lots. In the case of those animals only, serum made in the laboratory from hyperimmunized animals was used. Increase of the dose of serum from 200 cubic centimeters to 300 cubic centimeters practically stopped losses.

It is believed on the basis of the previous work(6) and that of Holmes(5) that an animal may be immunized by simultaneous inoculation without showing either fever or symptoms. Therefore, it is thought possible that more susceptible animals may have been immunized than shown in the table.

Table II gives data concerning the number of animals in each lot which attained maximum temperatures of a degree corresponding to four classes chosen arbitrarily.

TABLE II.—*Febrile reactions among carabaos at Laoag.*

Maximum.	Lot No.—											Totals for each temperature class.	
	1	2	3	4	5	6	7	8	9	10	11	Number.	Per cent.
40° or over.....	4	15	45	33	11	10	1	2	2	15	20	158	^a 69.6
39°.5 to 39°.9.....	0	12	1	8	3	2	1	1	2	6	14	50	^a 22.0
39° to 39°.4.....	0	1	2	2	1	1	0	1	2	1	8	19	^a 8.3
Under 39°.....	4	42	15	22	12	2	8	22	25	29	21	202	^b 47.1
Nonreactors.....													
Total number of animals.....	8	70	63	65	27	15	10	26	31	51	63	429	

^a Per cent relation to 227, the total number of reactors.

^b Per cent relation to 429, the total number injected.

It will be noted that 46.3 per cent of all failed to reach 39° C. and are not reckoned as having shown a febrile reaction in accordance with the standard described above. Comparatively few attained a temperature between 39° and 39°.5.

In considering the results of immunization, there arises a question regarding the general susceptibility to rinderpest of the animals in the district where the work was carried on. In as much as a very strict system of quarantine and inspection of animals was in force in the same province at practically the same time, some data can be presented. During the period from September 20 to December 27, 1913, in the same province and in almost adjoining municipalities, 94 cases of rinderpest were discovered of which 36 died, a number corresponding to 38.3 per cent. This in our experience is a moderately low death rate; we have observed it to vary from 33 per cent to 100 per cent elsewhere. A low death rate is generally considered to indicate a high resistance of the animals to the disease or a low virulence of the strain of virus harbored by the animals in the community. Therefore, with regard to the death rate prevailing naturally at the time, the work of immunization was conducted under favorable circumstances.

Subsequent to the work of immunization at Laoag, extensive work of the same kind for the general public has been carried on at Dingras and at Solsona by Dr. J. R. Burns.

From October 11, 1913, to January 25, 1914, 1,657 animals were immunized in these municipalities, not counting 954 animals injected previous to this date but not completed. More would have been injected during the period but for the fact that 65 liters of serum have been shipped to Manila for use in starting the work elsewhere. The total number of deaths during immunization for the period was 23, which corresponds to 1.3 per cent of the number injected.

As the work has progressed, the expense has been materially lessened. The immunization of 429 animals at Laoag cost the Bureau 3,994.11 pesos, about 9 pesos per animal. The work was essentially experimental in character and was conducted slowly and cautiously.

Conditions of routine field work are more closely represented by the work in Dingras and Solsona. For the period October 11 to December 31, 1913, the following expenditures were made by the Bureau:

<i>October.</i>		
Salary of 1 veterinarian, 5 days, at 333.33 pesos per month		Pesos. 55.55
<i>November and December.</i>		
Salary of 1 veterinarian, at 333.33 pesos per month		666.67
Wages of 10 laborers, at 20 pesos per month		400.00
Wages of 2 laborers, at 45 pesos per month		180.00
Expendable supplies furnished during period		123.55
Total		1,425.77

No item is included to cover cost of autoclave, bleeding table, and like apparatus which are permanent in character. Autoclaves complete with gasoline heating apparatus are obtainable for 300 pesos and bleeding tables cost 93 pesos each. At all times during the work, several veterinarians and inspectors have participated in the work to receive instruction in technique, but as their presence was unnecessary for doing that work their salaries and traveling expenses have not been included in the statement of expenses. Only five days of the time of one veterinarian during October is charged for, as he was employed on the work in Laoag for the remainder of October.

Estimates of the number of animals immunized per month and the cost based upon the early period of the work do not constitute an index of progress under conditions when it is thoroughly under way. A scarcity of serum during the early stages limits the economical employment of labor. Thus from October 11, 1913, to January 25, 1914, an average of 473 animals per month was immunized at a cost of approximately 1.50 pesos per head. During the four weeks beginning December 28, 790 animals were released. However, during this same month, 1,056 were injected, which will be approximately the number of immunized animals that will be released a month hence. Estimating the expenses for salaries, labor, and supplies at 685 pesos per month, which is the average for November and December, it is concluded that the immunization of the 1,056 animals injected during the month beginning December 28 cost the Bureau 65 centavos apiece. It is believed that this rate of progress can be improved by instituting certain changes affecting the amount of travel.

Had the serum employed in Dingras and Solsona been produced in a serum laboratory, there would have been an added expense up to January 25 of 21,932 pesos, reckoning the cost at 24 pesos per liter. This would have brought the expense up to 8.40 pesos per animal, a cost deemed prohibitive.

At the inauguration of the work, the owners of the animals to be immunized constructed the group of laboratory sheds shown in Plate I, fig. 1. The bleeding is done in the partially inclosed shed in the right background. Plate I, fig. 2, shows a carabao in this shed, restrained for bleeding. The first stage of placing an animal on the table is shown in Plate II, fig. 1, and the method of bleeding in Plate II, fig. 2. Both of the last two operations were photographed in the open air in order to obtain better light. The veterinarian holding the needle and one assist-

ant customarily stand on the opposite side of the animal. Other parts of the group of buildings in Plate I, fig. 1, house the office and general workroom. The bottles of blood after drawing and while the serum is exuding from the clot are placed in the stream bed in the inclosed building in the foreground. Adjoining these sheds are others for accommodating animals during immunization, the construction being of the cheapest character and primarily designed merely to afford complete shade. Another shed in the group shown in Plate III, fig. 1, contains stocks for restraining the animals during injection. The process of injection in this shed is shown in Plate III, fig. 2.

Serum is all prepared at the central laboratory and all immunized animals are brought there for bleeding. Immunization is carried on in other localities, some of them 10 kilometers distant, serum from the laboratory being sent out in demijohns. In every case, the owners of the animals have cheerfully constructed the necessary sheds. When these are needed, each man brings with his carabao one or two bamboo poles and a bundle of grass, and assists in the construction.

Each animal immunized is branded on the right shoulder with numbers designating the province and municipality. All animals immunized in Ilocos Norte bear the number 1 and to the side of this is placed a number referring to the municipality. Thus the brand 11 indicates Laoag; 12, Dingras; and 13, Solsona; all in Ilocos Norte Province. Further, the animals in each municipality bear serial numbers which are entered on the immunizing records, with owners' names.

A certificate of immunization is issued for each animal when released. This contains a printed outline of an animal, upon which are indicated brands and other distinguishing marks, together with description, name of owner, etc.

Animals accompanied by a certificate of immunization are exempted from any quarantine for rinderpest that is enforced by authority of the Director of Agriculture.

CONCLUSIONS

1. The writers believe that their experience with simultaneous inoculation with blood drawn in the field has demonstrated that there is no necessity for maintaining an expensive permanent laboratory and herd for the production of antirinderpest serum from hyperimmunized animals.

2. A radical reduction in the cost of serum production has

been effected, and in consequence the possibility of extensive employment of simultaneous inoculation in combating rinderpest has been demonstrated.

REFERENCES

- (1) BRADDON, W. LEONARD. Report to the Government of Negri Sembilan on an experimental investigation into the methods of protection of buffaloes and cattle against rinderpest. Kuala Lumpur (1902).
- (2) TURNER, G. Rinderpest in South Africa. *Journ. Trop. Vet. Sci.* (1906), 1, 269.
- (3) GIBSON, ADAM. A method of dealing with rinderpest in the field. *Journ. Trop. Vet. Sci.* (1910), 5, 23.
- (4) SHEALY, A. S. Some facts and ideas about rinderpest and their relation to the Philippines. *Proc. Am. Vet. Med. Assoc.* (1910), 397.
- (5) HOLMES, J. D. E. Rinderpest. Further investigations on questions connected with the economical production of antiserum. *Memo. Dep. Agr. India. Vet. Series* (1913), II, 2.
- (6) WARD, A. R., and WOOD, F. W. Experiments on the efficiency of anti-rinderpest serum. *Bull. P. I. Bur. Agr.* (1912), 19.

ILLUSTRATIONS

PLATE I

- FIG. 1. Field laboratory for the production of antirinderpest serum, Dingras, Ilocos Norte.
2. Method of restraining animal for bleeding.

PLATE II

- FIG. 1. Method of restraining animal on bleeding table.
2. Operator drawing blood for the production of serum.

PLATE III

- FIG. 1. Shed in which animals are injected with virulent blood and serum.
2. Operator injecting carabaos with virulent blood and serum.



Fig. 1. Field laboratory for the production of antirinderpest serum, Dingras, Ilocos Norte.

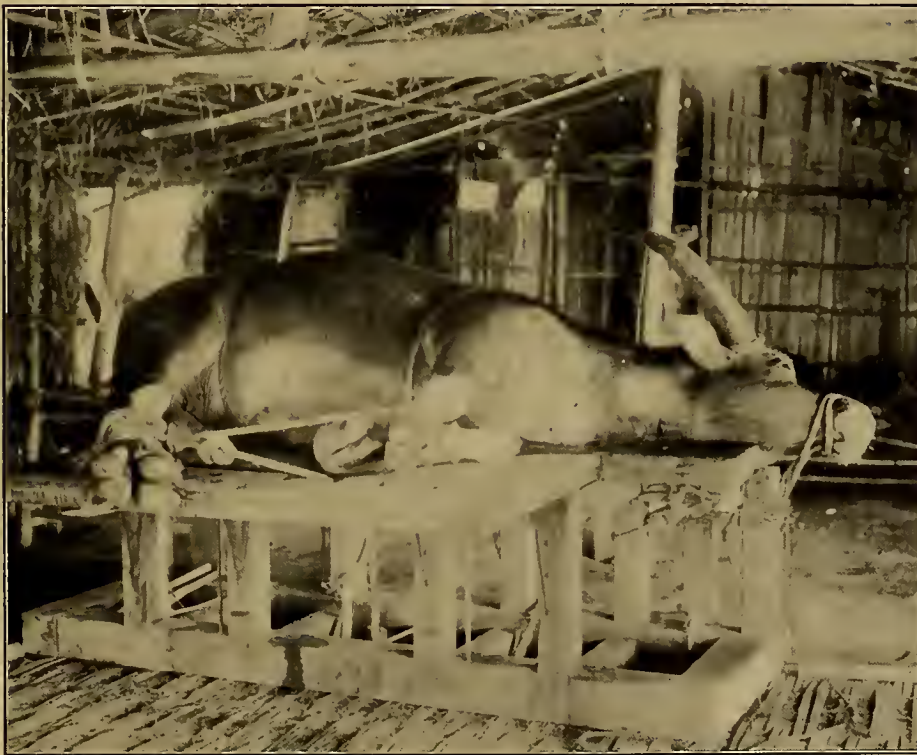

Fig. 2. Method of restraining animal for bleeding.

PLATE I.



Fig. 1. Method of restraining animal on bleeding table.



Fig. 2. Operator drawing blood for the production of serum.

PLATE II.

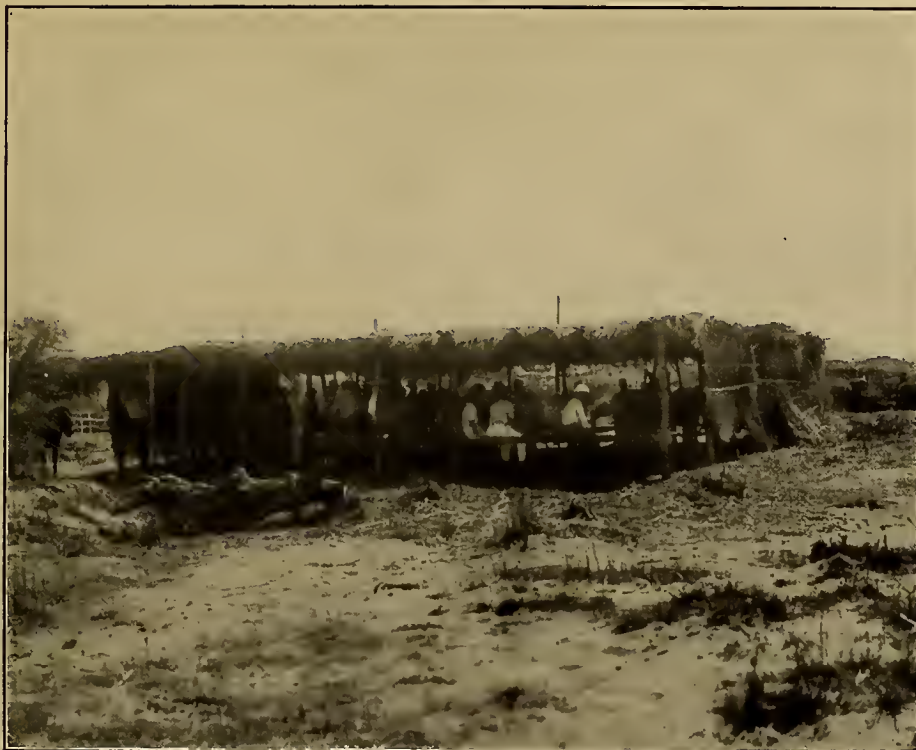

Fig. 1. Shed in which animals are injected with virulent blood and serum.



Fig. 2. Operator injecting carabao with virulent blood and serum.

PLATE III.

**PUBLICATIONS FOR SALE BY THE BUREAU OF SCIENCE,
MANILA, PHILIPPINE ISLANDS—Continued**

BOTANY

A FLOEA OF MANILA

By **JOHN D. MERRILL**

Order No. 419. Paper, 490 pages, \$2.50, stapled.

Practically a complete flora of the cultivated areas in the Philippines. Descriptions with keys, of over 1,000 species, 590 genera, and 120 families, with native names, quality of technical terms, etc.

THE COCONUT PALM IN THE PHILIPPINE ISLANDS

Order No. 37. Paper, 149 pages, 30 plates, 72 pictures.

The present contains the following articles: The Water Relations of the Coconut Palm (Hansen, 1907); The Coconut and Its History in Cebu and The Keeping Quality of Coconuts in and the Causes of its Spoilage; and The Principal Insects Attacking the Coconut Palm.

INDO-MALAYAN WOODS

By **FRANZ W. FROBENIUS**

Order No. 411. Paper, 180 pages, 9 plates, \$0.50, postpaid.

The Indomalayan Wood-Dinner-Fox contains a complete list of a large number of species, including the accompanying trees, including woods of economic value.

ZOOLOGY

A LIST OF THE MAMMALS OF THE PHILIPPINE ISLANDS, MALACA, CEBU, AND THE ISLANDS OF THE DISTRICT

Order No. 412. Paper, 64 pages, 70 illustrations.

This is the only recent attempt to give a complete list of mammals of the Philippine Islands. The descriptions of each species are given, and the original descriptions are cited.

ZOOLOGY—Continued

A MANUAL OF PHILIPPINE BIRDS

By **RICHARD C. MERRILL**

Order No. 103. Paper, 120 pages, 769 pages, \$4, postpaid.

A Manual of Philippine Birds contains in compact form descriptions of all the known species of Philippine birds. The usual keys and diagnoses of orders, families, and genera help the novice in identification.

A CHECK-LIST OF PHILIPPINE FISHES

By **DAVID STARBUCK** and **ROBERT E. REYNOLDS**

Order No. 102. Paper, 72 pages, \$0.75, postpaid.

This list will be found useful to guide to the systematic of Philippine ichthyology. The nomenclature is thoroughly revised, and the distribution of each species within the Philippine Islands is given.

MEDICINE

REPORT OF THE INTERNATIONAL LEAGUE CONFERENCE

Published by the League of Nations, 1911 under the auspices of the League of Nations.

Edited by **THOMAS MERRILL**, JR., PH.D., and **ROBERT E. REYNOLDS**, M.D.

483 pages, 16 plates (2 colored), 4 half-tones, 12 maps and maps.

Order No. 416. Paper, \$2.50; cloth, \$3.00, postpaid.

The proceedings of the International Conference on Bacteriology, Geneva, 1911, together with the results of various bacteriological investigations, constitute the present report.

The League of Nations of the Government of the Philippine Islands has been appointed sole agent for the distribution of the printed proceedings of the International League Conference.

BOOKS ARE IN UNITED STATES CURRENCY

Orders for these publications may be sent to the **BUSINESS MANAGER, PHILIPPINE JOURNAL OF SCIENCE, BUREAU OF SCIENCE, MANILA, P. I.**, or to any of the agents listed below. Please give order number.

- McGraw-Hill Company, 64-66 Fifth Avenue, New York, U. S. A.
- Wm. Wesley & Sons, 28 Essex Street, Strand, London, W. C., England.
- Wolters Noord, Lange Voorhout 9, The Hague, Holland.
- Wiley & Sons, Printers General Administration, 2, Avenue, N. W., Germany.
- Wells & Wells, Ltd., 52 Raffles Place, Singapore, Straits Settlements.
- A. W. & S. Ferguson, 13 Balfour Street, Colombo, Ceylon.
- Thacker, Spink & Co., P. O. Box 24, Calcutta, India.

CONTENTS

	Page
BARBER, M. A. Cockroaches and Ants as Carriers of the Vibrios of Asiatic Cholera	1
HEISER, VICTOR G. Reappearance of Plague in the Philippines after an Absence of Six Years. Brief Description of the Outbreak, the Methods Used to Combat it, and the Probable Factors in its Introduction	5
BOYNTON, WILLIAM HUTCHINS. A Preliminary Report of Experiments on the Cultivation of the Virus of Rinderpest in Vitro.....	39
BOYNTON, WILLIAM HUTCHINS. An Atypical Case of Rinderpest in a Carabao	45
WARD, ARCHIBALD R., WOOD, FREDERICK WILLAN and BOYNTON, WILLIAM HUTCHINS. Experiments upon the Transmission of Rinderpest	49
WILLETS, DAVID G. Intestinal Parasitism, Particularly Entamoebiasis, in Patients of the Philippine General Hospital, Manila, P. I.	79
WILLETS, DAVID G. Preliminary Report on the Treatment of Entamoebiasis with Ipecac, Emetine, and Neosalvarsan at the Philippine General Hospital, Manila, P. I.	91
GIBSON, E. B., and CONCEPCION, ISABELO. Nerve Degeneration in Fowls Fed on Unhusked Rice (Palay)	117
WARD, ARCHIBALD R., and WOOD, FREDERICK WILLAN. Simultaneous Method of Inoculating Cattle and Carabaos with Serum from Animals that have been Recently Immunized	133

	U. S. Currency
The "Philippine Journal of Science" is issued as follows:	
Section A. Chemical and Geological Sciences and the Industries	\$1.00
Section B. Tropical Medicine	1.00
Section C. Botany	2.00
Section D. General Biology, Ethnology, and Anthropology (Section D is run with Volume V)	2.50
Entire Journal, Volume II, III, IV, or V	5.00
Entire Journal, beginning with Volume V	7.50
Single numbers of Volume I75
Single numbers (except of Volume I)50
Volume I, 1906 (not divided into sections) and supplement, sold only with a complete file of section A, B, or C	10.00
Supplement to Volume I (Botany)	3.50
Volume I (without supplement), sold only with a complete file of section A, B, or C	6.50

Each section is separately pagged and indexed.

Publications sent in exchange for the Philippine Journal of Science should be addressed: Library, Bureau of Science, Manila, P. I.

Subscriptions may be sent to the BUSINESS MANAGER, Philippine Journal of Science, Bureau of Science, Manila, P. I., or to any of the agents listed below:

AGENTS

The Macmillan Company, 64-69 Fifth Avenue, New York City, U. S. A.
 Wm. Wesley & Son, 28 Essex Street Strand, London, W. C., England.
 Martinus Nijhoff, Lange Voorhout 6, The Hague, Holland.
 Mayer & Müller, Prinz Louis Ferdinandstrasse 2, Berlin, N. W., Germany.
 Kelly & Walsh, Limited, 32 Raffles Place, Singapore, Straits Settlements.
 A. M. & J. Ferguson, 19 Beilie Street, Colombo, Ceylon.
 Thacker, Spink & Co., P. O. Box 54, Calcutta, India.

VOL. IX, SEC. B, No. 2

APRIL, 1914

THE PHILIPPINE JOURNAL OF SCIENCE

ALVIN J. COX, M. A., PH. D.

GENERAL EDITOR

SECTION B

TROPICAL MEDICINE

EDITED WITH THE COÖPERATION OF

E. L. WALKER, S. D.; M. A. BARBER, PH. D.; A. R. WARD, D. V. M.
Committee on Experimental Medicine

V. G. HEISER, M. D.; W. E. MUSGRAVE, M. D.; B. C. CROWELL, M. D.
Committee on Clinical Medicine

R. C. MCGREGOR, A. B.



MANILA
BUREAU OF PRINTING
1914

THE PHILIPPINE
JOURNAL OF SCIENCE

B. TROPICAL MEDICINE

VOL. IX

APRIL, 1914

No. 2

SANITARY SURVEY OF THE SAN JOSÉ ESTATE AND ADJACENT
PROPERTIES ON MINDORO ISLAND, PHILIPPINE
ISLANDS, WITH SPECIAL REFERENCE TO
THE EPIDEMIOLOGY OF MALARIA

By A JOINT COMMISSION OF REPRESENTATIVES FROM THE
COLLEGE OF MEDICINE AND SURGERY, UNIVERSITY OF THE PHILIPPINES;
BUREAU OF SCIENCE; AND BUREAU OF HEALTH

Three maps

MEMBERS OF THE COMMISSION

Dr. W. E. MUSGRAVE

*Dean of the College of Medicine and Surgery; Chief of Staff, Philippine
General Hospital; Chairman of the Commission*

Dr. E. L. WALKER

Acting Chief, Biological Laboratory, Bureau of Science

Dr. THOMAS W. JACKSON

District Health Officer, Bureau of Health

Mr. CHARLES S. BANKS

Entomologist, Bureau of Science

Dr. ANTONIO VAZQUEZ

Instructor in Surgery, College of Medicine and Surgery

Dr. P. GUTIERREZ

Instructor in Medicine, College of Medicine and Surgery

Mr. F. A. DALBURG

Geologist and Topographer, Bureau of Science

Dr. I. CONCEPCION

Assistant, Bureau of Science

Dr. SETH L. COX

Interne in Medicine, Philippine General Hospital

Mr. ARISTON GUZMAN

Assistant, Bureau of Science

CONTENTS

1. Introduction.
2. Geography and Geology.
3. The General and External Sanitary Problem.
4. The Internal Sanitary Problem.
5. The Mosquito Survey in and near San José.
6. The Disease Index.
 - (A) Laboratory examinations.
 - (B) Clinical examinations.
7. Special Reports.
 - (A) A comparison of the spleen index with the microscopic examination of the blood for malarial parasites in 1,003 persons.
8. Summary and Conclusions.
9. Recommendations.
10. Appendix.

1. INTRODUCTION

By W. E. MUSGRAVE

The property included in this survey lies on the west coast of Mindoro (fig. 1), and comprises from 210 to 260 square kilometers of territory. It is bounded on the one side by the ocean, on the opposite side by the mountains of the island, inhabited by the wild tribes of the country, while up and down the coast are located a number of very insanitary and unhealthy barrios. Along the ocean front, within banca distance of the property, are a number of small islands and inland points inhabited by thriftless, ignorant, and disease-infected settlers.

For more years than can be remembered by the oldest living inhabitant or than may be traced in history, the place has been known as the "white man's grave" and probably with a considerable show of justification. During the last few hundred years, the Spaniards made several attempts to avail themselves of the fertile lands of this estate, and, in each instance, failed because of the unhealthful conditions and the high mortality among their employees. The Mañgyans, wild tribes of the adjacent mountains, refuse to make more than transient visits to these lowlands, and have a superstition that, if they remain more than seven days without returning to the hills, they will become sick and die. So far as can be learned, malarial fever was then, as it is to-day, the principal cause of the high mortality rate among residents of this community, although other infectious diseases are about as prevalent as they are elsewhere in the Philippine Islands.

To place this property, generally known as the San José Estate, in a satisfactory sanitary condition and subsequently to maintain it in a normal sanitary equilibrium will require an enormous

amount of well-directed energy and a great deal of money, and when accomplished this work probably will be the greatest sanitary achievement of a private corporation in history.

At first glance, the problem of the Mindoro Company and the San José Estate would appear to be one impossible of accomplishment with the expenditure of a reasonable amount of money; and it is probable that, had the owners of the properties realized



FIG. 1. Mindoro Island, showing the location of San José Estate.

the magnitude and the complexity of their sanitary problem in advance, the attempt to develop the agricultural resources of the country would have been delayed indefinitely. However, the developments of the company already are of some three years' duration, enormous sums of money are invested, progress in sanitation has been made, and the present personnel of the directorate realizes that it is necessary to make its properties habitable in order to insure the success of the large agricultural undertaking.

The sanitary problem of the Mindoro property compares favorably in magnitude with that of the Canal Zone. The total area of the Canal Zone is between three and four times as large as that of the Mindoro property, but the boundary lines and surroundings as well as the internal difficulties are so much greater in the Mindoro property than they are in the Canal Zone, that the sum total of the two problems should not be considered very different. In the Canal Zone, every interest is subservient to the digging of the canal. In the Mindoro property, drainage, irrigation, and other requisites for successful agricultural cultivation must be maintained while the sanitary problem is being solved. In both places, labor must be imported to do the work. Panama is fortunate in being able to select a more healthful class of employees, because of an unlimited supply and consequent ability to enforce more rigid physical requirements. In Mindoro, the labor practically must come from other parts of the Philippine Islands, and, in consequence, is made up largely of Filipinos. The extreme difficulty in securing this class of labor in sufficient numbers has made it seem advisable for the corporation to disregard the health of applicants for work, and consequently unhealthy people—a large number of them even suffering from infectious diseases—have been, and constantly are being, imported into the estate.

In Panama, due to the resources of a national government, it has been possible to protect the boundary lines both by sea and shore, and, with the abundant supply of labor and with the ability to enforce rigid physical requirements to applicants for positions, what may be termed the "external problem" of Panama is a very simple one compared with that of the Mindoro Company.

If the enormous sums of money expended for sanitation in the Canal Zone are considered to have been economically administered and necessary for the protection and safety in that area of property 16 kilometers wide and 64 kilometers long, it would not seem possible to solve the equally complex and difficult sanitary problem of the Mindoro Estate within the bounds of any financial consideration consistent with the profitable investment of money. However, with the expenditure of funds inestimably small compared with that of Panama, very marked progress has been made in the sanitation of Mindoro, and it is believed that it is possible, under wise direction, to solve this problem with the expenditure of funds consistent with profit for the investors in this large agricultural undertaking.

The properties of the Mindoro Company and the San José Estate are the most valuable on the west coast of Mindoro, and,

by the reason of the attempted modern improvements, represent a large majority of the enterprises of the entire island. The majority of the population of this coast is included in the employees of the above-mentioned companies, and the corporations' sanitary problem, therefore, becomes the sanitary problem of the east coast of the island, a fact which must be recognized both by Government authorities and by the officials of the company if a successful sanitary administration of the affairs of these corporations is to be expected.

The solution of the sanitary problem of the epidemiology of malaria in this peculiar environment, with labor selected from among oriental people from various infected centers, appeared to be so important that after due consideration and with the approval of the Honorable, the Secretary of the Interior, representing the Government, and the hearty and generous coöperation of Senator George H. Fairchild and other officials of the Mindoro Company and San José Estate a joint sanitary commission, selected from the personnel of the College of Medicine and Surgery, University of the Philippines; the Bureau of Science; and the Bureau of Health, undertook the sanitary and medical survey of this property.

The list of the personnel of this commission has been given, and the findings and recommendations will be found in the subsequent pages of this report.

After a brief preliminary consideration, the work of the commission was divided as follows:

- I. Topography and geology, by Mr. F. A. Dalburg.
- II. The external problem, a sanitary and medical survey, by Dr. W. E. Musgrave, chairman of the commission.
- III. The work of the internal problem was divided into four sections as follows:
 1. The internal sanitary survey, by Dr. T. W. Jackson of the Bureau of Health.
 2. Laboratory section, under the direction of Dr. E. L. Walker, of the Bureau of Science, assisted by Doctor Concepcion and Mr. Guzman of the same Bureau.
 3. Clinical section, under the direction of Doctors Vazquez and Gutierrez, College of Medicine and Surgery, and Doctor Cox, interne, Philippine General Hospital.
 4. The entomologic survey, under the direction of Mr. Banks of the Bureau of Science, assisted by Mr. Dalburg, of the same Bureau, and the mosquito brigade of the San José Estate.

It is needless to say that all these various sections of work were so correlated as to make the study of individual case records applicable through all sections of the work. The laboratory sec-

tion performed blood examinations and stool examinations and made hæmoglobin estimations. A series of 1,120 employees and members of their families were examined clinically by the clinical section, with particular reference to the general physical efficiency, condition of the skin, respiratory system, circulatory system, and abdomen, paying particular attention to the "spleen index." The entomologic survey was of a general nature, particular attention being paid to the location of breeding places of the anopheline mosquitoes and a study of all species of mosquitoes possibly concerned in the transmission of malaria. The sanitary survey consisted in a systematic investigation of the property of the company as follows:

Population: Men, women, children.

Births.

Deaths: Adults, children.

Medicines: Quinine, quality and method of use; patent medicines, kind and quality sold.

Food supply: Rice, varieties and quantities used; canned goods; meat; greens; chickens and eggs; miscellaneous foods.

Water supply: Kinds, sources, method of handling, class of consumption.

Sewage and garbage: Collection and disposal.

Water-closet facilities.

General grounds: Stables, manure, etc.

Houses: Construction, overcrowding, lighting.

Cooking: Where and how.

Laundry: Where, how, by whom, frequency of changes.

Bathing: Facilities and customs.

Venereal problem.

House surroundings: Underneath and around; animals.

Flies and mosquitoes.

The findings of the various sections of the commission are discussed under appropriate headings in the various articles making up this report. The last two chapters of the report, namely, the summary and conclusions and the recommendations, bear the unanimous indorsement of the commission.

2. GEOGRAPHY AND GEOLOGY

By F. A. DALBURG

Situation.—The San José Estate is situated in the southwestern part of Mindoro and on the low plain at the foot of the western cordillera system. Mangarin formerly was the principal place of habitation, but at present the new town of San José has been built near the center of the estate. San José is surrounded by lowlands which formerly had only a vegetation of talahib and buri palms, but is now devoted to the cultivation of sugar cane. (Fig. 1.)

Area.—The area of Mindoro is given in the Atlas Filipinas as 10,987 square kilometers (3,972 square miles) with a coast line of 518 kilometers (322 statute miles). The San José Estate contains an area of 22,485 hectares (55,538 acres).

Drainage.—There are several streams passing through the San José Estate of which the two principal ones are the Busuanga and Lumintan (Luminatao, Lumitao) Rivers. These rivers flow all the year round, and furnish abundant water for irrigation purposes. The smaller streams have an intermittent flow or form submerged marshes. These marshes during the rainy season become lakes, and are the source of numerous smaller streams that are dry during the months of no rainfall.

Routes of travel.—San José is reached from Mangarin Point by the Mindoro Company railway. There is a trail leading from Mangarin to the town, which was formerly the means of access. Very little traveling is done to the north of the town as the country is thinly settled.

Geology.—Most of the plain is alluvial, but shows exposures of conglomerate and shales toward the foothills. These in turn rest on the igneous rocks which form the base of the mountain system. Along the mountain range, white cliffs can be seen which evidently are composed of limestone. To the south of the estate at Santa Teresa, the natives quarry coralliferous limestone for use in the sugar industry. It is stated that about 24 kilometers north of the estate are oil seeps, and in the mountains are numerous caves of limestone. No investigation of the alleged oil seeps was made, because of lack of time.

Soil.—The soil on the estate varies from silt to a very clayey loam. Considerable portions of the land near the large rivers are composed of sand and gravel. In other portions the soil is a loamy clay, black to yellow in color. Where the clay material predominates, it may be necessary to drain the fields to insure a good soil for crops. In the more sandy soil where the retentive power is low, irrigation will be necessary to insure sufficient water for the cane fields.

Water supply.—The water supply is obtained from artesian wells which give a good quantity of potable water. In the outlying districts, dug wells are used and also small wells dug in the sand of the rivers.

3. THE GENERAL AND EXTERNAL SANITARY PROBLEM

By W. E. MUSGRAVE

The general sanitary problem may be divided into what may be termed the external problem and the internal problem. Ob-

viously, in a community where both malaria and tuberculosis—two transmissible and dangerous diseases—have an exceedingly high incidence, it will be necessary to control the external conditions with as much care as is required in dealing with the internal problem.

In the place under investigation, the external problem is a tremendous one, and presents some unprecedented phases. The eastern boundaries of the property are in the foothills of the Mindoro mountains where the wild tribes, the Maṅgyans, about whom very little is known, live, and practically nothing is known of the incidence and varieties of infectious diseases among them. Fortunately, intercommunication between the employees of the corporation and other citizens of the lowlands, on the one hand, and the wild men of the mountains, on the other, is rather limited. However, due to trade requirements and the increasing attitude of friendship, the association between these people is becoming more general, and in the course of time this mingling will influence the sanitary problem, both of the lowlands and the wild tribes of the mountains. Up and down the coast line, north, south, and west of the properties of the corporation, there are located a number of barrios and villages with the closest association and intermingling of populations that it is possible to obtain.

THE MUNICIPALITY OF PANDOROCAN

At the present time, all the part of the east coast of Mindoro including the properties of the Mindoro Company and the San José Estate is within the municipality of Pandorocan, and this municipality, in turn, is under the provincial government of Mindoro, which is located at Calapan on the opposite coast of the island.

The geographic outlines of the municipality of Pandorocan are shown in fig. 1. It consists of the properties of the Mindoro Company and the San José Estate, divided as follows:

	Estimated population.
Bugsanga Camp No. 1	500
Lubang Camp No. 2	1,400
Mindoro Camp No. 3	820
Kaminawit Camp No. 4	100
Irrigation Canal No. 2	300
Japanese Camp No. 5	50
Flowing Camp No. 2	50
Total	3,200

The following outlying barrios contain practically all the remaining population of the municipality.

	Estimated population.
Pandorocan	35
Mangarin	280
Caguray	100
Santa Teresa (Lalaoigan)	150
Ilin Island	400
Calintaan	300
Bulalacao	200
Total	1,465

A sanitary investigation of a number of the barrios has been made as follows:

Mangarin.—With a population of approximately 300 people, Mangarin is the oldest inhabited village in Mindoro, being nearly three hundred years old. During its existence of these hundreds of years, its population has remained practically constant, the deaths being just about equal to the births. It is located on a low-lying point in Mangarin Bay, is surrounded by swamp marshes, and is without drainage. It will be impossible to institute drainage without incurring unjustifiable expense. The total value of the improvements and real estate in the entire town does not exceed 5,000 pesos.¹ The inhabitants are dirty, lazy, and diseased. A medical survey of the population shows a “spleen index” among the children of 98 per cent; a clinical anæmia index of practically the same figure; a skin-disease index of 100 per cent; a very high incidence of tuberculosis and intestinal diseases; and an infant mortality that is simply appalling.

After a rather careful examination of this population, it is my firm belief that every man, woman, and child of the village is infected with malaria, and certainly every one of them has scabies, and, in most instances, there is at least one other skin disease present. The most practicable way of reaching Mangarin from San José is by train to Kaminawit (port of Mangarin), a distance of approximately 15 kilometers, and thence by boat to the village, a distance of about 2 kilometers. The intercourse between the people of this village and San José is constant and considerable. The only excuse for the existence of this village is that it is convenient to very profitable fishing water.

Santa Teresa (Lalaoigan).—Santa Teresa is a comparatively newly constructed village with a very nearly ideal location. It

¹ One peso Philippine currency equals 50 cents United States currency. One peso equals 100 centavos.

is on sandy soil in the foothills with plenty of drainage and good water supply, and is about 10 kilometers by water from Mangarin. At the present time, the "spleen index" among the children is 24 per cent, and this malaria incidence is explained by a single breeding place of mosquitoes in which many anophelines were found by Mr. Banks during our investigation. Otherwise, the inhabitants of this village are remarkably healthy; with the expenditure of a very small sum of money the location could be made ideal from a health standpoint for a modern sanitary barrio or even a city.

Toong (estate of the Recoleta Fathers).—The small barrio of Toong is situated in a beautiful valley of the Caguray River, and ought to be, with very little attention to sanitary arrangements, an ideal barrio. As it is now, there are several breeding places for anophelines, and the "spleen index" of the children is 36 per cent. In one house, containing only one room, 18 persons live, eat, and sleep; the cooking is done in this same room. There are in this house at the present time 8 cases of malaria and 2 of tuberculosis; there is 1 child with congenital syphilis, and there have been 2 deaths from malaria during the past twelve months.

Caguray.—The village of Caguray is situated on the opposite bank of the Caguray River and over 1 kilometer southwest of Toong. The "spleen index" among the children of this town is 80 per cent, and there are numerous breeding places for mosquitoes. The location of the village is satisfactory, and with very little attention to general sanitary conditions could be made a very healthful spot.

Pandorocan.—Pandorocan is the capital of the municipality of the same name. It is located on the property of the Mindoro Company, and consists of temporary houses which also are the property of the Mindoro Company; the whole place formerly was a temporary railroad camp. There is a population of between 35 and 50 people with the usual municipal officers, including 1 Constabulary officer and 4 Constabulary soldiers. One of the soldiers was ill in bed with malarial fever at the time of the inspection; one other gave a history of chronic malaria, and 3 of the 4 had enlarged spleens. The "spleen index" of the entire population is 65 per cent. All of the members of one family consisting of father, mother, and 4 children had malarial fever. There were a number of cases of tuberculosis, and the majority of the population are under nourished and anæmic.

It seems that the location of the capital of this municipality at Pandorocan was an accident. It is a deserted railroad camp of the Mindoro Company with a few poorly constructed houses and a total population of about 35 people, including the municipal authorities and 4 Constabulary soldiers. It certainly is not located in a particularly healthful spot, neither is it easily accessible to most of the important barrios or other properties under its jurisdiction.

The entire population of the municipality numbers about 5,500, of which approximately 3,200 are employees and families of the Mindoro Company and San José Estate; the rest of the population is distributed among the above-mentioned barrios. The income of this municipality is unusually large for one of its size, and a vast majority of this revenue comes from the taxes paid by the Mindoro properties. At the present time, there are about 12,000 pesos in the treasury. The municipality owns no real estate and no permanent buildings. The funds of the municipality, as well as its ordinances and other legal procedures, are under the jurisdiction of the provincial government of Mindoro with headquarters at Calapan.

Detailed information regarding the disposal of municipal funds was not investigated, but it is certain that satisfactory police and sanitary protection are not given to the inhabitants of the municipality, neither are police and sanitary protection nor any other benefits furnished the Mindoro Company and San José Estate in return for the large share of the taxation which is borne by these corporations.

The barrios of this municipality are the poorest located, poorest cared for in both police and sanitary protection, and are the most generally and severely infected villages that I have seen in the Philippine Islands. One barrio, namely Santa Teresa, of the entire municipality has a satisfactory sanitary location, which in this case is all but ideally chosen. Water supply, drainage, easy approach by sea with deep water close to the shore, sandy soil, and shade trees are the principal advantages offered. At a very small expense, all possible breeding places for mosquitoes could be destroyed and a very desirable location for the municipal capital established.

It is recommended that Santa Teresa be selected as the capital of the municipality and that the headquarters now at Pandorocan be transferred to this site.

It is further recommended that the barrio of Mangarin be transferred to Santa Teresa, for as stated in another place in this report satisfactory sanitary conditions in this barrio can-

not be obtained and maintained with the expenditure of any reasonable sum of money.

In view of the fact that such a large percentage of the revenue of the municipality is received by taxation of the Mindoro properties, it is recommended that satisfactory police protection and justice of the peace accommodations be furnished San José as a partial return for this revenue. At the present time, the municipality governs through ordinances, and in general the local officials have very little authority to transact Government business in proportion to the requirements of the situation. The enormous expenditure of private funds and the rapid growth in the population of Pandorocan make it necessary that the form of government now in existence in this municipality be modified and that it be strengthened to meet the demands of the situation. It is assumed that the Government maintains the right of proper sanitary and legal supervision of the properties of the corporations interested in Mindoro in exactly the same way that it retains similar supervision over the private properties and estates of other citizens and corporations of the country, and the situation at the present time in San José is such as to demand serious consideration and more active, aggressive, and competent discharge of the usual governmental duties and privileges granted to citizens of thickly populated districts.

The health problem in San José and the surrounding barrios is such an important one that it should be under the supervision of a thoroughly competent and well-trained public-health official with all the authority usually delegated to such an officer. The corporations interested in the territory under discussion already have very large sums of money invested, and constantly are increasing this investment. It is to their interest that the present unsatisfactory health conditions be improved, and the management of the companies is showing a very commendable spirit in its attempt to improve these conditions. However, it is handicapped in many particulars, not the least of which is the lack of authority for the enforcement of just sanitary laws and regulations among the employees and other inhabitants of the property. The Government is interested in the improvement of sanitary conditions for the same reasons that it is interested in this problem in other parts of the country, and the solution of the difficulties at San José is not possible except under the combined efforts of the corporations and the Government officials under a united directorate.

From a careful investigation of all phases of this question on the ground, I am fully convinced that the corporation in-

terests are ready and anxious to meet the Government in any proposition looking to the alleviation of the very unsatisfactory conditions existing at the present time, and I recommend and urge that the Government take up this matter on a broad basis, reach a line of agreement for methods of work, and proceed to clean up the area in question and remove the stigma of the "white man's grave" from one of the richest and most attractive territories of the Philippine Islands. Definite recommendations regarding this point will be found in another place of this report.

4. THE INTERNAL SANITARY PROBLEM

By THOMAS W. JACKSON

As a member of the Mindoro Malaria Commission, representing the Bureau of Health, I made certain observations, under the direction of the chairman of the commission, relating to various phases of the health problem at the San José Estate and adjacent properties. These observations may be grouped under the general title, The internal sanitary problem. Consideration was given in this investigation to the following subjects: (1) Topography and climate; (2) population, individually and collectively, from a medical standpoint; (3) housing conditions and nutrition; (4) the sanitary and medical organization; and (5) a study of the causes for the high morbidity and mortality rates at San José.

I. TOPOGRAPHY AND CLIMATE

The San José estate is situated on the low plain that extends from the coast to the foothills of the mountains in southwestern Mindoro. (Fig. 1.)

This plain is intersected with numerous arroyos which contain flowing water at all times and which in the rainy season become deep and torrent-like streams. The two great rivers are the Busuanga and the Lumintan, flowing in somewhat parallel directions from the mountains to the sea and distant about 12 kilometers from each other. The Lumintan is the most northwestern, and crosses a portion of the sugar estates, while the Busuanga passes directly through and across the estates within 1.5 kilometers of the sugar mill. Magbando River, a smaller parallel stream, flows close to the sugar mill, and with its branches provides a running-water system through the "Mindoro" and "Lubang" camps, and furnishes as well a natural irrigation system. The banks and bed of this stream have been

the scene of much clearing during the past year as an anti-mosquito measure.

Talahib grass covers the greater part of this plain, growing to a height of 4.5 meters in some places. Naturally, it furnishes excellent shelter for mosquitoes, especially in the rainy season,



FIG. 2. The townsite of San José Estate, Mindoro.

when the streams overflow their banks and inundate the entire tract. Talahib grass, however, is something of an index of the suitability of the soil for sugar culture; therefore, it may be expected eventually to disappear entirely before the steam plows of the sugar planter, which have already converted 616 hectares of talahib-covered area into sugar-cane fields.

An extensive and elaborate system of ditching and draining has been undertaken and is going forward under the direction of the engineers. This cannot fail greatly to facilitate the control of mosquito breeding, just as the disappearance of talahib deprives the mosquitoes of their natural shelter. The increased porosity of the soil from cultivation should be of great assistance in lessening the number of mosquito-breeding places.

The climate of San José does not differ materially from that of other portions of the Philippines of similar latitude (12° north), and as the altitude of this plain in few places exceeds 15 meters above sea level no extremely cool weather is to be expected, but sea breezes during the southwest monsoon meet with no obstruction and temper the climate pleasantly. During three of the six nights spent at San José, comfort demanded a heavy blanket or two light ones. Upon the other three nights, a very light covering sufficed.

There is nothing in the climate, in itself, to account for the unhealthfulness of this region. The vegetation and rainfall combine to provide breeding places for mosquitoes, and in this indirect way only may the climate justly be held responsible for malaria. With extensive cultivation and drainage, we should expect the ultimate passing of the mosquito and the repetition of the history of malaria in the lowlands and river bottoms of the central United States, once notorious by reason of the so-called paludial fevers, but now healthful and providing wealth and sustenance to the millions of prosperous people resident there.

II. POPULATION, INDIVIDUALLY AND COLLECTIVELY, FROM A MEDICAL STANDPOINT

In the matter of composition, the population may be described as heterogeneous; while the Filipinos predominate largely, Japanese, Chinese, Americans, Hindus, and Negroes are also present. The Japanese are the second strongest people numerically, while the Chinese and Negroes are very few in numbers. The population of San José, comprising the three camps of Lubang, San José, and Mindoro, for the quarter ending December 31, 1912, was given in the official health report of the surgeon to the company as 2,800, while that of the third quarter of the year, ending September 30, was given as 3,285. An average population of 3,000 people may, therefore, be assumed. It is ultimately proposed to employ and quarter 10,000 persons, according to the statement of company officials.

The exact influence of race and nationality upon the resistance of this populace to disease cannot be estimated, and even approximate estimates would be of little value.

It is my opinion, based upon physical examinations, that the American comes first in physical fitness, with the Japanese second. The Filipino is more subnormal in development than any of the other nationalities, and next higher, but not greatly above him in the physical scale, comes the East Indian. The habits of life and of religion, in the case of the Hindus, may play some part in the determination of their resistance to disease, but no generalizations are possible.

The tractability of the various nationalities also enters into the problem, and in this regard I believe the Filipino, under proper authority, to be fully as tractable and amenable to sanitary and medical restraints and discipline as any of the other races represented here. I emphasize the matter of authority, in as much as it is absolutely vital to the solution of this problem, and at present it seems to be the most neglected part of the sanitary and medical scheme.

Concerning the matter of resistance to the sun's heat and light, we have no reliable data, and the present confusion and disagreement among students as to the effects of tropical light upon man warrant us in devoting ourselves to a search for more tangible and evident causes of disease.

As to the general physical condition of the working populace at San José at the present time, it may be said that the people are poorly nurtured and anæmic. Many are harboring malaria parasites, and are suffering from the blood-destroying activities of these organisms. Considering the character of the work done and the hours of labor, all are underfed and are thereby rendered less resistant to invasion by most of the infectious diseases. A good many are tuberculous and consequently unfit for service of any kind. The term "semimiserable" does not understate the physical condition of the people in general.

I am unable to give the proportion of women and children to the 3,000 inhabitants, but it is certainly much less than that normally existing in Filipino villages. The adult population furnishes the greater portion of the sickness.

Of the deaths occurring during the last quarter of 1912, 18 per cent were among children, whereas in Manila the constant percentage of deaths among children exceeds 50 per cent of the whole.

During the two months immediately preceding our visit, 10

children were born, twice the number which died in the final three months of 1912. No previous records of births were obtained.

III. HOUSING CONDITIONS AND NUTRITION

Housing conditions.—As the sugar companies are endeavoring to work out the question of proper housing, I will only say that, in my opinion, the barrack system now in use is defective in many ways and that the individual (family) house seems to promise better results generally. The condition of overcrowding and of insanitary interior partition of barracks into small rooms exists, and needs correction badly.

Much trouble, in my opinion, might have been avoided, had the companies exercised their undoubted right to regulate interior as well as exterior conditions about their houses. Until such time as they do so, no system of house building will remedy the unwholesome conditions which exist. That the companies can limit the number of persons per house; exclude chickens and animals; prevent the unauthorized construction of partitions, sleeping closets, and sleeping shelves in their buildings; oversee ventilation; and insist upon the maintenance of screens and upon the use of the sanitary appliances provided by them is as plainly possible as it is for them to regulate outdoor conditions.

Nutrition.—The important matter of nutrition can only be dealt with here in a general way. The fact of general malnutrition or subnutrition among these people was abundantly established by the commission.

The methods of supplying food for the laborers and their families were investigated, and as a result the fact that the food is sold at an abnormally high price was established. Members of the commission priced the staple articles of food on sale at the company stores and at tiendas, and found that prices were decidedly higher than those prevailing throughout the Philippines, and in many cases exceedingly high.

The messes of the restaurants conducted by the companies were also investigated, and it was found that three classes of meals were provided at rates of 20, 15, and 10 pesos per month, respectively for first-, second-, and third-class board. In the opinions of the chairman of the commission and myself, only the first-class board, at 20 pesos per month, is suitable to subsist a workman engaged at hard labor on the sugar estates. From inquiry of the mess managers, it was found that less than 5 per cent of the boarding laborers selected this fare. A larger percentage

paid 15 pesos for second-class board, but the great majority was found to be living on the 10-peso fare, which is an absolutely inadequate ration from either the viewpoint of caloric value or that of hunger satisfaction.

We need only to state the fact that the monthly wage of the laborer amounts to 26 pesos (for twenty-six working days), to make clear the reason why practically none of the men select the first-class fare. The situation in the case of the families providing and preparing their own food is less easily studied, but with the supplies at hand and the high prices demanded for necessities it cannot fail to be most unsatisfactory.

The remedies for these conditions are obvious, and I am of the opinion, as I have stated before, that the sugar companies are disposed to remedy evils brought to their attention. There must be provided for the people an abundant and constant supply of good food at fair prices. There should be vegetables, meats, and fish at all times. Excellent fish are obtainable close at hand, and vegetables may be grown without difficulty. Pigs and cattle should be raised and sold at prices within the reach of the populace, while chicken raising should be practiced and encouraged. There is no insuperable difficulty in the way of providing good food at living prices and in constant abundance, but something more than haphazard management and good intention is necessary to remove this real and regrettable state of affairs.

The relation of this nutrition question to health maintenance is sufficiently clear, and demands no argument. Without question, diminished resistance by reason of underfeeding is a factor entering into the matter of recovery from most infections, even if it cannot actually be shown to be a factor in the matter of infection itself. The fact that we have at San José, to start with, a class of workmen, underfed and deficient in stamina, only emphasizes the obligation on the part of those who engaged them, and in many cases imported them, to correct this underfeeding and to care for them physically in every necessary way. Of course, there is no reason why men should be retained in employment or maintained if they are intractable and if they resist sanitary and medical measures. It is extremely likely that many had malarial, hookworm, and tubercular infections when they arrived and that their physical woes were not at all acquired in Mindoro, but since they were accepted as workmen without physical examination they must now be properly fed and cared for or returned to their homes, regardless of the way they lived before accepting employment and residence in Mindoro.

IV. SANITARY AND MEDICAL ORGANIZATION

To establish the fact that the mortality and morbidity rates are actually high, let me quote briefly a few statistical notations from the San José hospital records.

Average population for 1912, 3,000. Total number of deaths from July 1, 1912, to January 18, 1913, 132. (If this rate for seven months were maintained for the entire year, the deaths would reach the number of 216, a death rate of 73 per thousand of population, or 7.3 per cent.) As a matter of fact, the monthly death rate has varied considerably. During the month of July, 1912, it exceeded 200 per thousand annually (statement of the company's surgeon). The death record of the periods previous to July 1, 1912, was not furnished.

The causes of death were obtainable in only the last 34 cases recorded (October 5, 1912, to January 18, 1913), and are as follows:

Malaria ²	18
Beriberi	3
Pneumonia and tuberculosis	6
Premature birth	3
Amœbic dysentery and enteritis	2
All other causes	2
	<hr/>
Total	34
Per cent of all deaths due to malaria	52

For the 98 deaths recorded from July 1 to October 5, 1913, diagnoses are recorded for but 34, of which 16 (or 47 per cent of the whole) are ascribed to malaria.

No numerical record of cases of malaria treated in hospital was furnished me, but if the record of deaths is even approximately correct a tremendous incidence may be inferred, if one has in mind the comparative rarity of death from treated malaria, even in tropical countries. For example, in 1899, only 4 deaths occurred among 1,904 infected persons actively treated at Pinar del Rio, Cuba.

When completed, the examination record of more than 1,100 blood smears taken from the people at San José will give a fair index of the degree of malarial infection here, but it must be remembered, of course, that not every infected individual examined will show parasites in the single specimen taken, especially as many of the infections are with the æstivo-autumnal

² All deaths in which the records designate malaria as one of the causes of death are included.

parasite, which in certain phases of its human cycle is practically absent from the peripheral blood circulation.

As for the so-called "splenic index," I share the belief held by a number of tropical workers that it is a very fallible criterion, especially in the presence of other anæmia-producing conditions, such as those which prevail at San José. It has a certain value, however, and so far as it goes it gives support to the clinical findings of malaria in San José.

In 1911, Schapiro reported a general splenic index of 17.7 per cent at San José, based upon an examination of 333 persons. For those under 16 years of age he found the splenic index to be 37+ per cent. From the same report we learn that in January, 1911, the estimated mortality rate per annum, based upon the month's deaths, was 88 per thousand, or 8.8 per cent.

The matter of the physical condition of the inhabitants of the near-by towns, while interesting and undoubtedly bearing considerable weight upon the problem before us, is less immediately important than is generally supposed, and it is certainly less so than the cure of the sick at San José. At San José, we have a present population of 3,000 persons, a large percentage of whom are infected with malaria. The combined population of the other towns and barrios of southwestern Mindoro, within a radius of 24 kilometers, does not approach this total. We have also to bear in mind the fact that to convey malaria to the San José sugar estates the human malaria carriers from these settlements must visit San José and encounter anopheline mosquitoes, or that laborers, women, or children from the sugar camps must visit the infected barrios and encounter infected anophelines.

The company's surgeon believes, not without some apparent reason, that, given complete control of the anopheline mosquitoes at San José, a condition which he believes to be actually attainable and even now measurably accomplished, the visiting malaria carriers will not constitute a menace to the inhabitants. He then needs only to fear that the uninfected people from San José will visit the barrios and towns and there acquire malaria, and he needs only to safeguard the members of this traveling population during their excursions and observe them after their return, treating such as acquire malaria while absent from the estates.

Theoretically sound, at least in part, this proposition appears to me to be absolutely impracticable of application and bound to result disastrously for several reasons.

One of these reasons is the impracticability of ever, or at

least within some years, securing such ideal mosquito-free conditions throughout the company's settlements as is contemplated. I consider this attainment improbable, in spite of the present dry-season indications and the admitted extreme scarcity of mosquitoes at San José. The rainy-season test has yet to be applied. Pending the results of this test, I confess that I am unconvinced of the absolute and permanent eradication of anophelines at San José.

Another reason is the impracticability of actually controlling the laborers and others, who visit infected barrios, during their absence from the estate and upon their return.

With an abundance of malaria carriers resident at San José—hundreds in fact—and a few anophelines to act as vectors, there is every reason to expect the disease to continue indefinitely at the sugar estates unless more active therapeutic measures be instituted.

In 1911,³ antimalarial recommendations were made for a drainage system that would entirely exclude mosquito life; for the leveling, grading, and drainage of the town site; and for the clearing of vegetation from the banks of the Magbando River and for clearing its channel and straightening its course.

These recommendations have been carried out so thoroughly that to-day the Magbando River at San José is an open, unobstructed waterway with banks practically denuded and offering absolutely no opportunity to the mosquito seeking a breeding place. The elaborate drainage system already installed and now undergoing construction, with cement gutters and drains and with straight deep ditch sides and proper grades, are indications of great effort and expenditure. The buildings are arranged symmetrically and in order in well-policed streets. All of these things speak in praise of the energy of the company's surgeon, the company's engineers, and the management which has supplied the large sums of money required. Mosquitoes at the time of our visit in January, 1913, were extremely hard to find. Yet malaria continues to exact a terrible toll in life and health.

Granting that some malaria is constantly introduced from the infected village of Mangarin, I am still unable to rid myself of the impression that the great majority of the fever cases occurring at San José are in "repeaters." The medical officers of the company stated to me that a very high percentage of the cases were recurrences. From inquiry, observation, and experience I know that the average length of time spent by malaria

³ *Annual Rep. P. I. Bur. Hlth.* (1911), 48.

patients in the hospital—from two to three days—is far short of the time required to cure cases of malaria. Furthermore, the routine treatment administered is not such as to lead me to expect any permanent cures, and with the lack of systematic after-treatment it would be strange, indeed, if the majority of the cases did not recur.

So far as the immediate problem is concerned then, I consider it a medical rather than a sanitary problem.

The following experiences caused me to feel sure of that which I had strongly suspected; namely, that many cases never come under the observation of a physician at all and do not appear on record anywhere, officially or otherwise.

As a member of the commission, one of the duties apportioned to me was that of making a house-to-house inspection of the three camps, Lubang, San José, and Mindoro. These inspections were made at various times.

On January 14, at about 2 p. m., I visited the most distant part of San José camp, extending along the Busuanga River bank. In the 5 houses nearest the end of the river row, I found 7 persons suffering with fever. Blood smears for examination were taken from all, and directions to visit the hospital were given. Only one person did so. Upon inspection of the same houses on the morning of January 15, I found that 6 of the 7 had returned to work. Upon the second visit, 5 new cases were encountered—all cases of malarial fever. None of these individuals had applied for treatment or was receiving it, and none is officially on record except the one who was persuaded to visit the hospital. These cases from San José included both simple tertian and malignant tertian (*æstivo-autumnal*) cases, and parasites were found without difficulty.

On January 17, while inspecting a cookhouse in the Mindoro camp, the head cook was found shaking with a chill. His blood contained malaria parasites.

On January 17, at 2 p. m., I visited a row of houses (4 barracks) in Lubang camp, and found 13 cases and took blood specimens from all.

The rest of the barracks, 22 in number, were then immediately inspected by another member of the commission (at 3 p. m.), who reported that about 50 persons were at home with fever at the time of his visit. About 30 blood smears were taken. Men, women, and children were included in this number of persons. None of the fever cases was "officially" sick, and none of the 26 cases casually discovered by me was under treatment.

A suggestive circumstance connected with my inspection was the surprise expressed by the sanitary policeman, who accompanied me through the Lubang camp buildings, that persons with "only a little fever" should require hospital treatment. He expressed the opinion that they "would all be at work to-morrow."

The following "condensed dispensary reports" were furnished at the San José Hospital in the morning of our return to Manila. I introduce them just as transcribed from the records.

TABLE I.—Condensed dispensary reports for week ending January 11, 1913.

	Febric- ula.	Con- juncti- vitis.	Acute coryza.	Diar- rhœa.	Surgi- cal.	Total.
Lubang (camp 1); population, 1,400:						
Cases.....	34	1	6	5	25	71
Days lost from work.....	34	1	7	6	31	79
Cases sent to hospital.....						5
Bugsanga (camp 2); population, 400:						
Cases.....	10		1			11
Days lost from work.....	17		2			19
Cases sent to hospital.....						
Mindoro (camp 3); population, 720:						
Cases.....	37		4	5	16	62
Days lost from work.....	39		6	6	23	74
Cases sent to hospital.....						5
Kaminawit (camp 4) (port of Mangarin); popu- lation, 80:						
Cases.....						
Days lost from work.....						
Cases sent to hospital.....						1
Irrigation canal (camp 2); population, 200:						
Cases.....	8		6	1	10	25
Days lost from work.....	8		6	1	12	27
Cases sent to hospital.....						5

Grand total dispensary service: Population, 2,800; patients, 169; days lost, 199.

Signed by physician in charge.

A striking omission from the list of diseases is that of malaria. Another is the fact that 99 out of 169 cases were cases of "febricula," a term practically banished from modern medical nomenclature. Substitute the term "malaria" for "febricula," and we have 58 per cent of all cases treated in dispensary due to malaria. The days lost from this cause, although averaging but one day per case, amount to 50 per cent of the total.

Concerning the so-called dispensary service, it seems to consist chiefly of a *practicante* who visits cases at their houses

and administers medicine. He may also send cases to the hospital, but as indicated by the above reports and by the commission's investigations he does so with comparative rarity. The clinical thermometer may be a familiar diagnostic instrument to him, but the clinical microscope apparently is not. This service should scarcely be dignified with the name "dispensary."

A STUDY OF THE CAUSES OF THE HIGH MORBIDITY AND
MORTALITY RATES AT SAN JOSÉ

Doctor Schapiro of the Bureau of Health gave as the cause of sickness, at the time of his inspection in 1911, the following 9 factors: (1) Long hours of work; (2) overcrowding in hot houses; (3) low nourishment in a poor class of laborers; (4) unsafe water supply; (5) lack of mosquito protection; (6) delayed medical attention; (7) poor hospital facilities; (8) no sanitary control of garbage and fæces collection; and (9) fly propagation in the corral, strewn garbage, and fæces about residences.

With regard to (1) long working hours, (2) overcrowding in hot houses, and (3) low nourishment in a poor class of laborers, it may be said that all of these causes still operate, although some attention has been given to all of them by the companies. (4) Unsafe water and (5) lack of mosquito protection have received a great deal of attention, and are no longer active factors of sickness, except that individual mosquito protection is not practiced. However, a square kilometer and a half of territory have been practically freed from mosquitoes, and this, it must be admitted, is an accomplishment of great value. The artesian wells and distribution system have completely and satisfactorily solved the water question. Supply, quality, and service are highly satisfactory for present needs. (6) Delayed medical attention—not due to fault upon the part of medical officers, however—and (7) poor hospital facilities still continue to operate in the manner I have pointed out elsewhere in this report. By the reforms inaugurated and operated by the companies, factors (8), garbage and fæces collection, and (9), fly propagation and soil pollution by garbage and fæces, have ceased to operate. This does not mean that breakdowns in the machinery of the sanitary system never occur. On the contrary, I think that they are rather frequent in occurrence. The important thing is the fact that a system of collection and disposal has been installed and will eliminate the dangers from those wastes and insects if properly supervised.

Having in mind the most important cause of sickness at San José, malaria, the following factors deserve special consideration: (1) Lack of disposition on the part of the infected people to seek medical attendance; (2) lack of authority on the part of the doctors and company officials to compel hospitalization of the sick and adequate after-treatment; (3) inadequate hospital facilities and medical forces; and (4) lack of confidence on the part of the medical staff of its ability to cure malaria and to maintain medical surveillance and control over out-patients.

1. *Lack of disposition on the part of the people to seek medical attendance.*—The attitude may be explained in part by native superstition and ignorance, together with dread of the routine method of medication for malaria practiced at the hospital; namely, iced baths and hypodermatic injections. A significant matter in connection with this lack of disposition to go to the hospital is the fact that upon admission to the hospital the pay of the employee stops.

The remedies for this condition of apathy are (a) education (entirely too slow for our present purpose), (b) compulsory hospitalization, (c) modification of the routine treatment so as to be less terrifying to the superstitious native, and (d) continuance of pay of employees while in the hospital.

2. *Lack of authority, on the part of the doctors and company officials, to compel attendance at the hospital by the sick, and lack of adequate after-treatment.*—It must be admitted that this condition seems to be a purely fictitious one. It is difficult to understand why a vast corporation, owning its land and villages; controlling transportation to and from its own estates; furnishing houses, rent free, to its employees; maintaining timekeepers, overseers, sanitary policemen, practicanes, and a hospital system, is powerless to enforce the proper treatment of these laborers when they are sick.

Yet I have for my authority the specific statement of the company's surgeon that he is entirely unable to enforce proper hospitalization and out-patient treatment. In reply to my question, "What means of enforcing hospital attendance of your laborers and detention for a suitable period of time have you?" he answered, "Absolutely none." One can only explain this alleged condition by two alternative hypotheses. One is, that the corporation fears to lose some of its laborers by insisting upon proper medical treatment and that it prefers to maintain the number at a certain figure, even though many are diseased and inefficient (for it must, of course, be aware that efficiency

goes only with sound, healthy workmen). The second hypothesis, and the one I choose to accept, is simply this: Neither of the companies concerned realizes that it is actually clothed with absolute control over the laborers, by virtue of the discharge and exclusion power; nor do the companies realize the true seriousness of the situation and the extent of malarial infection and invalidism. This last impression is emphasized by the repeated statement of company officials that "in spite of malaria" the sugar camps are as healthful as any villages of similar size in the Philippine Islands.

The study of the commission absolutely negatives this contention, and the death rates settle the matter beyond question; there is no need to dwell longer upon this point.

I have no hesitancy in stating that less than one-half of the people who suffer from acute malaria at San José come under the observation or treatment of the medical officers. These untreated individuals cannot fail to perpetuate the disease in the sugar camps.

3. *Inadequate hospital facilities and medical forces.*—There is evident need of another hospital at San José. The present plan of treating surgical cases, diarrhœal diseases, skin diseases, tuberculosis, and malaria in common wards is a poor one, to say the least, and the present hospital is badly crowded. Floor space and cubic-air space at least twice as great as the present hospital offers are needed for the present service and, as I have already indicated, the number of patients treated in hospital and for the adequate period of detention should be doubled. Malaria cases and tuberculosis cases should be separately housed in well-screened buildings equipped with modern facilities. Elaborate and expensive buildings and apparatus are unnecessary; but the hospitals should be of ample size, comfortable, and well arranged, having in view utility and modern sanitary administration. A laboratory room should be provided.

The medical force should be doubled at least. The addition of another medical officer, who should be a clinician and a microscopist, is absolutely necessary if good work is to be done. It is manifestly impossible for the present staff to handle the hospital administration, the clinical material at hand, the laboratory work and the out-door sanitary supervision, and antimosquito work required at present. Then, too, the demands will be greater, rather than less, for some time to come if the general plan of hospitalization of all the sick be carried out, as I strongly recommend. I can see no escape from this conclusion. Imagine

Fort William McKinley, near Manila, where a similar number of persons are cared for under vastly more favorable conditions, provided with a medical staff of one American doctor and one Filipino assistant, aided by one native trained nurse. While the needs of Fort William McKinley, with its staff of ten or more surgeons, are not to be fairly compared with those of the San José Estate, death rates and sick rates for a similar population (numerically) are bound to be compared. The right to live and to receive proper care in time of sickness is a common one, and is an obligation equally binding upon governments and business corporations.

4. *Lack of confidence, on the part of the medical staff, in its ability to cure malaria.*—With regard to the curability of malaria, I can only express my regret that such a lack of confidence exists. I have become too thoroughly convinced by experience in hundreds of cases of malaria of all kinds, studied clinically and microscopically for a long period of time, that malaria is a perfectly curable disease—although not always an easily curable one—to have this confidence shaken by the present apparent failures, especially in the light of the conditions of treatment existing at San José.

5. THE MOSQUITO SURVEY IN AND NEAR SAN JOSÉ

By CHARLES S. BANKS

The region comprised in this brief survey is, like many others, namely, Manila, Iloilo, Olongapo, Subig, and Cavite, ideal with respect to the conditions under which the malaria mosquito can breed. The coast being nearly flat, tidal swamps and esteros cut far inland and thereby create an enormous area of semi-stagnant salt marsh, in which, unaffected by sudden and complete tidal washings, algæ abound and mosquito larvæ find ample breeding and feeding grounds.

By reference to the accompanying map, it will be seen that all the localities mentioned lie near or on the zone of tidal swamps and the people are therefore placed under conditions which are perfect from the standpoint of exposure to mosquito attacks. It is likewise highly probable that those who were born or have lived for long periods of time in these localities have become permanent malaria carriers; and it is as a result only of the recent attempts to import laborers from other more or less malaria-free regions and the consequent infection of nonimmunes with acute symptoms that attention has been again strongly directed to this locality as a malarial region.

Since the establishment of the permanent settlements of the San José Estate and the Mindoro Company at San José, the outbreaks of malaria have been so frequent and of such a pernicious type, both among officials and laborers, that the companies have found it very much to their advantage to take active steps to eradicate mosquitoes within the inhabited area of their plantations and to screen the houses of those employees intelligent enough to keep screens in repair and screen doors properly closed.

The area shown on the map, inclosed within solid red lines, has been practically freed from both anophelines and culicines by the process of drainage and oiling, but outside this area there are breeding places of both *Myzomyia rossii* and *Culex ludlowii*, the two forms being usually associated in the same breeding places. (Plate I.)

Busuanga River irrigation site.—This meandering river is an ideal place for the best development of *Myzomyia* and *Culex*, it being, at the time of my visit, somewhat low and its valley thickly dotted with isolated pools in which algæ grew most luxuriantly and mosquito larvæ bred abundantly.

Enough larvæ of *Myzomyia* were found in the intake site of the company's irrigation ditch to keep the colony in a continuous state of malarial infection. Indeed, several Filipinos and Americans who had been sleeping for a number of weeks at this place were in hospital suffering from severe malaria at the time of my visit.

The same abundance of anopheline larvæ was noted at the Magbando Camp, some 3 kilometers southwest of San José, and where the river had during 1912 carried away about 3 hectares of sugar cane.

Railroad.—The entire line of the railroad, from the wharf at the port of Mangarin to the line limit for antimosquito measures at San José, lies first through tidal swamp land and then through land containing creeks, streams, and more or less stagnant ditches and ponds where *Myzomyia* larvæ were found without exception and in abundance.

The ease with which mosquitoes can be carried from this region to the town of San José will be more apparent when it is stated that in a trip made after nightfall from Mangarin wharf to San José, in one of the open passenger cars of the company, I captured at least 3 females of *Myzomyia rossii* attempting to bite me, who was one of at least 30 passengers. It might also be said that in the whole trip of 15 kilometers which consumed just seventy minutes, but two stops were made. There was absolutely no breeze at this time.

Amindan River.—Amindan River, a small creek southeast of San José, was found infested with *Myzomyia* and *Culex* larvæ as shown in the map.

Mangarin.—The village of Mangarin from the standpoint of insanitary location could probably not be excelled anywhere in the Philippine Islands. This is a well-laid-out town 300 years old, with fairly clean streets and well-maintained fences, together with houses somewhat above the average of construction and cleanliness, set down in a tidal swamp. The effects of the proximity of mosquito-breeding places are shown by the appalling splenic index among the children of 98 per cent and an anæmia among the adult population which was absolutely general.

It is needless to state that malaria mosquitoes were found in very great abundance in and around this place and that the only possible solution of the malaria problem here would be to abandon the place completely.

This single village is an incubator where the germs of the disease are maintained year after year to be sent out in ambulating cultures from which every anopheline that bites them can draw an abundant supply of the organisms of pernicious malaria for the infection of other persons.

Santa Teresa.—Santa Teresa, situated on Lalaogian sandspit, about 10 kilometers from Mangarin wharf, and having about 150 inhabitants, is fairly free from malaria mosquitoes; but outside of the town, along an ill-defined estero or swamp area, were to be found breeding places of both *Myzomyia rossii* and *Culex ludlowii* with limited numbers of larvæ at the time of my visit.

This town seemed to be the most promising from the standpoint of ease of sanitation of all the towns seen in this portion of Mindoro.

Toong.—About 13 kilometers from Mangarin wharf and 6 kilometers from the mouth of the Caguray River is situated the barrio or rancheria of Toong belonging to the Recoleta Fathers and used as headquarters for those laborers who herd the cattle belonging to this order. The ground is generally high and fairly well drained, but along the river banks are to be found breeding places of *Myzomyia* in fair abundance.

Children in Santa Teresa and in Toong, examined by Doctor Musgrave, showed spleen enlargement indicative of chronic malaria infection.

Caguray.—Caguray, a small, well-laid-out, and fairly clean town, is 4 kilometers from the mouth of the river of the same

name and 11 kilometers from Mangarin wharf. It has the same general topography as Toong and the same conditions favorable to the breeding of *Myzomyia*. Larvæ were found, not in abundance, but the spleen index of 44 per cent, higher than that of Toong which is only 36 per cent, indicates that at certain periods in the year mosquitoes are more abundant than at the time of my visit.

I have no hesitancy in asserting that not a single town, barrio, or settlement in the whole region within easy traveling distance by small boats of the San José estate is a desirable one from which to draw laborers or from which to allow visitors to the Mindoro plantation, on account of the great probability that they will be malaria carriers and that a little relaxation on the part of those charged with keeping the "living area" of San José free from *Myzomyia rossii* will immediately result in these laborers or visitors serving as a source of infection to employees brought from other places in the Islands. That San José and its immediate environment can be freed and kept free from mosquito infection is within the range of possibility, but only at the cost of unceasing vigilance and an absolute coöperation between the engineers in charge of the field operations and the sanitary officer and his assistants.

CONCLUSIONS

The site for San José was ill chosen, as is admitted by all concerned, but such an enormous outlay of money has been made by the companies interested that the only alternative now left them is the additional expenditures for keeping up preventive measures already begun on a small scale.

Eventual drainage of the area adjacent to the railroad for its entire length will be necessary before this means of transportation can be freed from the present menace to the inhabitants of San José.

The surrounding towns and barrios must be permanently isolated from communication with San José so long as mosquito-breeding conditions in them remain as they are now and such a large percentage of the population are carriers of the malaria germ.

Oiling and removal of algæ from breeding places of *Myzomyia* are at best a mere makeshift until drainage operations can be instituted; but one or the other of these processes must be constantly employed so long as fresh or salt water remains stagnant or even semistagnant in the neighborhood of San José.

My experience at San José in connection with the breeding

places of *Myzomyia rossii* and the prevalence of malaria confirms the experiences which I have had at Olongapo,⁴ Cervantes, Bontoc, Subig, Iloilo, Cavite, and Baguio. While other species of anopheline mosquitoes occur in these localities in very limited numbers, *M. rossii* is extremely abundant in all of them. It is the species known to breed in both fresh and salt water,⁵ and it is the only species in abundance in the Philippine Islands, which is a proved carrier of malaria here as well as elsewhere.⁶

6. THE DISEASE INDEX. (A) LABORATORY EXAMINATIONS

By ERNEST LINWOOD WALKER, ARISTON M. GUZMAN,
and ISABELO CONCEPCION

In consideration of the part played by malaria in the morbidity at the San José Estate, it was thought advisable to devote chief attention in the laboratory during this investigation to the examination of blood with special reference to malarial parasites. The examination of fæces to determine the incidence of infection with intestinal parasites was also undertaken, but owing to the limited time at our disposal this series of examinations was small.

Blood smears were made from 1,095 out of the total population of about 3,200 persons at San José. One large smear on a 1- by 3-inch microscopical slide was made from each person. Time permitted the thorough examination of only a few of these smears in Mindoro, and the remainder were brought to Manila for examination.

The blood smears were fixed in methyl alcohol, stained with Giemsa's stain, and examined with a 1/12-inch oil-immersion objective. With the aid of a mechanical stage, the preparations were subjected to a very thorough examination for malarial parasites. Attention was directed also in these examinations to the presence of other blood parasites, such as spirochætes, *Leishmania*, and filarial larvæ, and to any abnormalities in the blood cells, such as leucocytes containing malarial pigment and changes in the red blood corpuscles resulting from anæmia. Time did not permit making red and white blood-corpuscle counts, but the hæmoglobin was estimated in most of the cases by the Tallquist scale, and differential leucocyte counts were made of a certain proportion of the blood smears which showed malarial parasites. In these counts, owing to their large num-

⁴ *This Journal*, Sec. B (1907), 2, 513 et seq.

⁵ *Ibid.* (1908), 3, 335 et seq.

⁶ Theobald, *Monograph of the Culicidæ*. London (1907), 4, 47; (1910), 5, 19 (bibliographical).

ber, only 100 leucocytes were counted. Therefore, the results can be considered only as roughly approximate. The white corpuscles were classified in these counts as polymorphonuclear neutrophiles, polymorphonuclear eosinophiles, large mononuclears, and lymphocytes. Among the large mononuclears were included the transitionals and myelocytes.

In Table II are summarized the results of the examinations of blood smears from 1,095 persons for malarial parasites. In this table these persons are classified as well men, well women, well children, and fever patients. By "well" is meant persons who were up and about, performing their regular duties.

TABLE II.—The results of the examination of the blood of 1,095 persons for malarial parasites.

	Well men.	Well women.	Well children.	Fever patients.	Total.
Number examined	978	63	23	31	1,095
Positive:					
Total	333	14	10	16	373
<i>Plasmodium vivax</i>	135	7	5	10	157
<i>Plasmodium præcox (falciparum)</i>	139	9	7	11	216
<i>Plasmodium malarix</i>	9	0	0	0	9
Double infection	45	2	2	6	55
Negative	645	49	13	15	722
Percentage of infected persons	34.05	22.22	43.48	51.61	34.06

Malarial parasites were found in 373 or 34.06 per cent of the 1,095 persons examined. If we exclude the 31 persons who were ill in bed with fever, the percentage of apparently well persons who were harboring malarial parasites in their blood is not materially altered, being 33.55 per cent. Since only one blood examination was made of these persons and since malarial parasites are not always present in the peripheral circulation in sufficient numbers to be seen microscopically, it is probable that the true percentage rate is higher than 33.55.

This investigation was carried on in the dry season. The lack of rain together with the efforts of the sanitary officer in charge had reduced the mosquitoes within the boundaries of the estate to a minimum. With the advent of the rainy season, it is doubtful whether this condition could be maintained. Consequently, the incidence of infection at the time of these examinations was probably at its minimum.

The parasite rate obtained from the examinations of the blood of varying numbers of individuals has been reported from different regions, but in most cases this rate has been for endemic

malaria. The conditions in the Panama Canal Zone are, perhaps, the most nearly comparable with those in the San José Estate. In both places the population consists largely of imported laborers who are more or less nonimmune, and in both places prophylactic measures against malaria are practiced. Darling reported in 1910 (3) that he found malarial parasites in the blood of 13 per cent of 276 persons who were up and performing their regular duties. Our findings at San José show a much higher percentage of infection.

Considering them by groups, the individuals sick with fever naturally show the largest percentage of infected persons, it being 51.61 per cent. Well children, as is to be expected, come next with a percentage of 43.48 of infection. The well men follow with 34.05 per cent of infections. Lastly come the well women who were found infected to the extent of 22.22 per cent.

Of the total 428 infections with malarial parasites, 157 or 36.68 per cent were tertian, 216 or 50.46 per cent were subtertian, and 9 or 2.1 per cent were quartan. Double infections, chiefly with tertian and subtertian parasites, were found in 50 persons, and triple infections, consisting of double tertian and single subtertian infections, are recorded in 1 man and in 1 child.

No spirochætes or *Leishmania* were found in any of the blood smears, although a few of the persons examined were East Indians. Spirochætes have been found previously in the blood of an East Indian employee suffering from black-water fever on this estate.⁷ In a blood smear from one malarial case, a single filarial larva was found.

Gametes of the malarial parasite were found in only 98 or 26.27 per cent of the 373 infected persons. With few exceptions the gametes, when found, were few. Darling (4) has estimated that persons whose blood contains more than 12 gametes per cubic millimeter, or 1 gamete to 500 leucocytes, are capable of infecting mosquitoes, and consequently must be regarded as "malaria carriers." The blood of these 98 persons, and probably others, contained more than 12 gametes per cubic millimeter, and was, therefore, dangerous to other persons in the presence of the proper mosquito host.

With reference to the red blood corpuscles, the low hæmoglobin value and the absence of well-marked regenerative changes are noteworthy.

In 266 of the cases of malarial infection in which the hæmoglobin value was determined, it was as follows:

⁷ Ashburn, Vedder, and Gentry, *Bull. Manila Med. Soc.* (1912), 4, 198.

TABLE III.—The hæmoglobin index.

Hæmoglobin percentage.	Cases.	Percentage of cases.
40 to 49	2	0.75
50 to 59	18	6.76
60 to 69	88	33.08
70 to 79	96	36.09
80 to 89	46	17.25
90 to 100	16	6.01

Bates in 1913 and previously others have shown that in malaria the loss of hæmoglobin value corresponds very closely to the reduction of red blood corpuscles. Therefore, the low hæmoglobin index indicates a considerable deficiency in red blood corpuscles in most of these persons. However, in view of the fact that the majority of the persons in whose blood malarial parasites were not found also had a low hæmoglobin index, it seems probable that the anæmia in these people was not due wholly to malarial infection, but in part to their general poor physical condition.

In only 102 or 27.34 per cent of the 373 cases of malarial infection were anæmic or regenerative changes in the red corpuscles recorded. These changes consisted of polychromatophile corpuscles, basophile punctate corpuscles, and macrocytes. In most cases these were not numerous, and in no case were nucleated red cells observed. The changes in the red blood corpuscles do not appear to be commensurate with the degree of anæmia indicated by the hæmoglobin value in many of these persons.

The results of differential leucocyte counts in 165 of these cases of malarial infection are summarized in Table IV.

TABLE IV.—Summary of the leucocyte counts.

Leucocytes.	Cases falling into different percentage groups.							
	0-5.	6-10.	11-15.	16-20.	21-25.	26-30.	31-35.	36-40.
Neutrophiles.....					2	6	10	10
Eosinophiles.....	64	31	38	21	2	3	3	1
Mononuclears and transitionals.....	44	53	34	17	9	5	1	2
Lymphocytes.....	3	4	23	30	26	35	18	12

TABLE IV.—Summary of the leucocyte counts—Continued.

Leucocytes.	Cases falling into different percentage groups.							
	41-45.	46-50.	51-55.	56-60.	61-65.	66-70.	71-75.	76-80.
Neutrophiles	15	21	26	24	17	16	13	5
Eosinophiles		2						
Mononuclears and transitionals								
Lymphocytes	7	2	4			1		

The variation from the normal in these leucocyte counts is best brought out by another table which shows for each type of leucocyte the number and percentages of cases having a normal count and those having counts below and above the normal.

TABLE V.—Numbers and percentages of normal and abnormal leucocyte counts.

Leucocytes.	Cases having a count below normal.		Cases having a normal count.		Cases having a count above normal.	
	Num-ber.	Per-cent.	Num-ber.	Per-cent.	Num-ber.	Per-cent.
Neutrophiles (normal count, 60-75 per cent)	107	64.84	52	31.51	6	3.63
Eosinophiles (normal count, 2-4 per cent)	21	12.72	32	19.39	112	67.87
Large mononuclear and transitional (normal count, 4-8 per cent)	20	12.12	61	36.96	84	50.90
Lymphocytes (normal count, 20-30 per cent)	49	29.69	72	43.63	44	26.66

From Table V it is seen that in 64.84 per cent of these cases of malarial infection there was a diminution in the proportion of polymorphonuclear neutrophile leucocytes. This diminution in the neutrophiles appears to be more or less compensated for by an increase in the eosinophiles and large mononuclear leucocytes, 67.87 per cent of the cases showing an increase in the proportion of the eosinophiles and 50.90 per cent an increase in the proportion of the large mononuclears. The lymphocytes have a count below and above the normal in about an equal number of cases.

In only 15 of the 373 cases of malarial infection were large mononuclear leucocytes containing malarial pigment observed.

The conclusion of practical importance to be drawn from the blood examinations in these cases is that the blood picture, apart

from the presence of malarial parasites, was of little aid in diagnosing malaria under the conditions existing in this investigation. Only in the minority of cases in which there was a large increase of the large mononuclear leucocytes and in the extremely few cases in which leucocytes containing malarial pigment were found was the blood picture significant.

Thomson (5) has shown that there exists a considerable fluctuation in the leucocyte counts made at different stages of malarial infection. These fluctuations include a decrease in the total leucocytes in the peripheral blood during active malaria, varying more or less inversely with the temperature; an inverse relation between the number of mononuclear leucocytes and the temperature; and transient periodic leucocytosis, chiefly of the polymorphonuclear leucocytes, in latent malaria. These fluctuations would probably explain some of the variable differential leucocyte counts obtained in these cases.

The increase in the proportion of the eosinophile leucocytes found in a large number of these cases was probably due for the most part to intestinal parasites with which these persons were infected.

That so many apparently well adults show malaria parasites in their blood in the dry season when mosquitoes have been reduced to a minimum indicates a serious malarial problem for the promoters of the San José Estate; and the facts that the population of this estate is an imported one and that it is estimated that 90 per cent of the individuals remain for less than six months at San José and then return to their homes in various parts of the Archipelago constitute a grave public-health problem for the whole Philippines. This estate may be considered as a center of infection to which nonimmune persons are constantly coming and from which a constant stream of infected persons are going out to all parts of the Philippines. Since the mosquito that is incriminated in the transmission of malaria in these Islands is of wide distribution, these emigrating cases must serve as foci of infection in various parts of the Philippine Islands.

THE MICROSCOPIC EXAMINATION OF FÆCES FOR INTESTINAL PARASITES

The 58 stool examinations made were all of adult males. The results of these examinations are shown in Table VI.

TABLE VI.—*Examination of fæces for intestinal parasites.*

Examination and infections.	Number.	Per cent.	Examination and infections.	Number.	Per cent.
Persons examined	58	-----	Person infected with—		
Persons infected	53	91.37	<i>Oxyuris</i>	1	1.72
Persons infected with—			<i>Entamœba</i>	13	22.41
Hookworms	28	48.27	<i>Balantidium</i>	2	3.44
<i>Trichuris</i>	26	44.82	<i>Lambliã</i>	2	3.44
<i>Ascaris</i>	21	36.20	<i>Trichomonas</i>	1	1.72
<i>Strongyloides</i>	9	15.51	Total infections	105	179.31
<i>Dibothriocephalus</i>	2	3.44			

The results of this limited number of examinations show a percentage of infections with intestinal parasites not varying materially from that obtained by other investigators in the Philippine Islands. The only special points of interest in these examinations are the relatively high percentages of infections with *Strongyloides stercoralis*, *Dibothriocephalus latus*, and *Balantidium coli*, but the number of persons examined is too small for one to lay any great stress on the results.

LITERATURE

- (1) ASHBURN, P. M., VEDDER, E. B., and GENTRY, E. R. A spirillum in the blood of a case of black-water fever. *Bull. Manila Med. Soc.* (1912), 4, 198.
- (2) BATES, J. P. A review of a clinical study of malarial fever in Panama. III. Malarial anæmia. *Journ. Trop. Med. & Hyg.* (1913), 16, 209–213.
- (3) DARLING, S. T. Studies in relation to malaria. Gov. Printing Office, Washington (1910).
- (4) IDEM. Factors in the transmission and prevention of malaria in the Panama Canal Zone. *Ann. Trop. Med. & Parasit.* (1910), 4, 179–223.
- (5) THOMSON, D. The leucocytes in malarial fever: A method of diagnosing malaria long after it is apparently cured. *Ibid.* (1911), 5, 83–102.

6. THE DISEASE INDEX. (B) CLINICAL EXAMINATIONS

By W. E. MUSGRAVE, A VAZQUEZ, B. GUTIERREZ, and SETH L. COX

Of the total population of about 3,200 employees, together with women and children, of the San José Estate, 1,110 persons were examined clinically. The examinations were more or less superficial in character, but sufficient time was taken to determine, with a fair degree of accuracy, any gross pathological

changes that might be present. The persons examined consisted of:

Males	1,035
Females	75
Total	<u>1,110</u>

Tabulated by nationalities, they are as follows:

Nationality.	Males.	Females.
American	17	4
Filipino.....	961	67
Japanese	39	4
Indian	8	0
Spanish	3	0
American Negro	1	0
English.....	2	0
Scotch.....	1	0
German	1	0
Swiss	1	0
Greek.....	1	0
Total	1,035	75

It must be understood that the part of Mindoro under consideration formerly was practically uninhabited and that the population of 3,200 people represents emigrants from practically the entire Philippine Archipelago, so that the examination of these people, except in those diseases definitely contracted after arrival at Mindoro, represents, to a certain degree, an index of conditions found throughout the country.

The principal points in the physical examination of this entire group of persons is indicated below.

MALARIA

By reason of incidence and general morbidity and mortality effect upon the population in general, malaria ranks third in the sanitary problems in the Philippine Islands, infant mortality and tuberculosis holding the first and second places, respectively.

The distribution of malaria is very general. However, there are places in the Islands where the disease is unknown, and there are a number of other places where the infection is very severe, is constantly present, and where the disease has existed as far back as we have any record of the country.

Of all the infected centers, the west coast of Mindoro is popularly considered to be the worst. As is shown in other places in

this report, the barrio of Mangarin shows a "spleen index" among children of 98 per cent, and it is altogether probable that 100 per cent of the population of this place is infected with malaria. The inhabitants of San José, including the officials and employees of the Mindoro companies, are made up of a transient population recruited from all parts of the Philippine Archipelago. The incidence of malaria among these people is exceedingly high, and the morbidity factor is a most important one. In the examination of 1,110 employees and other inhabitants of this estate, positive enlargement of the spleen was found to be present in 26.21 per cent.

Examination of blood from 1,095 of these employees showed malarial parasites in 373, or 34.6 per cent. For a consideration of the relative importance of the "spleen index" and examination of blood smears in the diagnosis of malaria, see the special report by Doctors Walker and Cox, page 181.

The relation of the "spleen index" to ages of patients is shown in Table VII.

TABLE VII.—*Relation of spleen index to age.*

Age.	Cases examined.	Spleen.			
		Palpable.		Markedly enlarged.	
		Number.	Per cent.	Number.	Per cent.
1 to 5 years.....	21	3	14.30	4	19.00
6 to 10 years.....	10	2	20.00	5	50.00
11 to 20 years.....	494	62	12.50	88	17.80
21 to 30 years.....	393	53	13.50	44	11.19
31 to 40 years.....	119	13	10.90	8	6.70
41 to 50 years.....	48	3	6.25	4	8.33
51 to 60 years.....	14	0	0	1	7.14
61 to 70 years.....	2	0	0	0	0
71 to 80 years.....	1	1	100	0	0

It is, of course, probable that a certain small percentage of the enlarged spleens are due to causes other than malaria, but even eliminating these we still have a malaria incidence that is so high as to require radical measures for its reduction. In looking into the causes of these conditions, we have three important sources of infection; first, outside sources. A study of the records of people examined shows that they come from all provinces of the Philippine Islands, and the incidence of spleen enlargement, by districts and countries, is shown in Table VIII.

TABLE VIII.—Incidence of spleen enlargement, by districts and countries.

District.	Total number examined.	Positive spleen index.	Percentage.	District.	Total number examined.	Positive spleen index.	Percentage.
Albay	1	0	0	Malay States	1	0	0
Ambos Camarines	4	4	100.0	Marinduque	2	1	50.0
Antique	47	4	8.5	Mindanao	4	1	25.0
Bataan	5	2	40.0	Mindoro	74	36	48.6
Batanes	1	0	0	Naga	1	0	0
Batangas	19	7	37.0	Nueva Ecija	26	7	26.9
Bulacan	29	13	44.9	Nueva Vizcaya	1	1	100.0
Bohol	4	1	25.0	Occidental Negros	32	7	21.8
Capiz	112	36	32.1	Oriental Negros	2	1	50.0
Cavite	21	9	42.5	Palawan	29	0	0
Cebu	51	16	31.3	Pampanga	37	6	16.2
Ceylon	1	0	0	Pangasinan	38	14	37.0
Corregidor	4	0	0	Rizal	62	11	16.1
England	1	0	0	Romblon	5	1	20.0
Guam	1	0	0	Samar	4	1	25.0
Honolulu	1	0	0	Singapore	3	2	66.6
Ilocos Sur	16	4	26.6	Sorsogon	6	1	16.6
Ilocos Norte	1	0	0	Surigao	1	0	0
Iloilo	221	38	17.2	Tablas	5	3	60.0
India	3	0	0	Tarlac	153	49	32.0
Japan	38	10	29.0	Tayabas	8	1	12.5
Laguna	6	3	50.0	United States	7	0	0
La Union	7	0	0	Zamboanga	1	0	0
Leyte	4	1	25.0	Not given	2	0	0

These marked variations in the percentage of infection of persons coming from different provinces indicate that a certain number of these people already were infected with malaria before their arrival in Mindoro. This statement is inferentially corroborated by subsequent statistics made by "preëmployment" examination of people who are going to Mindoro. These laborers are recruited from various provinces of the Islands, and, roughly speaking, the "spleen index" among this class of people is averaging about 10 per cent. Therefore, it seems logical to conclude that approximately 10 per cent of the malaria of Mindoro is imported through the new recruits constantly arriving from all parts of the Islands.

The second source of infection is found in the barrios near San José. From the extensive infection of these places and the close travel association between them and San José, it is believed that approximately 5 per cent of the San José malaria may be accounted for in this way. Thirdly, the remaining 15 to 20 per cent of the total infected with malaria at San José are accounted for by the spread of the infection in San José and

the outlying camps of the corporations. The remedies for this malarial situation will be found in another part of this report.

TUBERCULOSIS

The work of the Philippine Islands Antituberculosis Society has revealed a rather startling condition of affairs regarding the incidence of tuberculosis among Filipinos. Most of the work of this society has been done in the city of Manila, and, consequently, deals largely with patients resident in Luzon; very little is known, statistically, of the incidence of this disease in the provinces.

Physical examination of 1,110 people, included in this report with reference to tuberculosis, gives the following result:

Positive	331
Doubtful	10
Negative	768
Not recorded	1
Total	<hr/> 1,110

In as much as these patients come from a large number of provinces as shown in a previous table, the figures quoted in the above statistics show a markedly high incidence and a remarkable general prevalence of tuberculosis. As the average residence of these people in Mindoro is, approximately, three months, it is assumed that the majority of them contracted this disease before they emigrated to this island. The enormous prevalence of tuberculosis is a very important factor both in the economic and in the health problem of Mindoro. With the present barrack system of quartering the employees in San José and the overcrowded condition of most of these barracks, such an enormous percentage of tuberculosis infection means disaster unless the situation is relieved in some manner. It is a well-known fact to those who have been studying the tuberculosis problem of this country for many years that the average laborer will not acknowledge that he is ill and will continue his ordinary vocation while suffering from this disease until hæmorrhage, excessive fever, or general weakness makes it impossible for him longer to make an effort to perform his work. The tuberculosis situation may very readily be controlled by a careful preëmployment examination of applicants for positions at Mindoro, excluding all those who have definite signs of the disease, and the condition of those already on the ground may be markedly improved by the establishment of a different residence system

from the one now in use. It is altogether probable that tuberculosis is a more important factor in the decreased capacity for labor among employees at San José than is malaria or any other one physical abnormality of the people.

HEART AND BLOOD VESSELS

Physical examination of the circulatory system of the 1,110 people gives the following result:

Valvular disease:	
Positive	78
Doubtful	4
Negative	1,028
	<hr/>
Total	1,110
Hæmic murmur	20
Chronic myocarditis	4
Tachycardia	11

There are no available statistics of the incidence of cardiac diseases among supposedly healthy people of the laboring classes in other countries, and it is, therefore, impossible to say whether the rather striking picture shown in these statistics is an unusual one.

The question of etiology and incidence of diseases of the heart and blood vessels in the tropics has received practically no consideration in medical literature. These conditions are among the important considerations in the medical work in this country. Whatever the difference in incidence between valvular diseases in the tropics and in the temperate climates may be, it seems very likely that the etiological factors are somewhat different. Statistical work dealing with this subject, based upon findings in our clinics of the College of Medicine and Surgery and the Philippine General Hospital, now are being made, and sufficient work has already been done to justify the statement that there exist in the tropics destructive valvular diseases of the heart that are not explained by the usual etiological consideration in these diseases. At this time, only two of the causative agents will be referred to; namely, environment and malnutrition.

The rather constant low blood pressure found among natives of the tropics as well as among foreign residents in the tropics is, in all probability, environmental in origin. Whatever is the exact cause, there is in the tropics a relaxed condition of muscular tone, with dilated peripheral blood vessels, slight tendency to œdema in dependent parts of the body, and a sluggishness of gastrointestinal metabolism and absorption as well as in the

function of the internal organs of secretion. This condition of affairs is intimately associated with myocardial changes, and it is altogether probable, although not an experimentally substantiated fact, that toxic conditions result from this general stasis which have positive effect in myocarditis in addition to the mechanical effects on the valves as a result of some cardiac dilatation.

Applicants for employment who have valvular diseases of the heart or show circulatory incompetency in any form should be excluded and not allowed to emigrate to Mindoro.

BERIBERI

Examination of 1,110 persons with reference to the incidence of beriberi gives the following result:

Positive	3
Doubtful	16
Negative	1,091
Total	<u>1,110</u>

In addition to the findings in this tabulation, we are creditably informed that at no time in the history of this estate has beriberi assumed an important rôle among the disease conditions. This is rather striking in view of the modern conception of the relationship of polished rice to this disease.

The development of Mindoro being in a very elementary stage, the local supply of fish and other foodstuffs is mostly imported from Manila and adjacent islands.

The diet of the people of the San José Estate consists almost entirely of polished rice, fish, and a few vegetables and condiments. In other words, the diet is about as poor as that of any class of Filipinos in the Islands.

HOOKWORMS

Stool examinations were made in only 58 cases, and 28 or 48.27 per cent of these were found infected. Most of these infections were light in character, and clinical inefficiency in these patients was but little, if at all, lower than the general average. We feel confident that hookworm infection at the present time is a small factor in the clinical inefficiency of employees of the San José Estate.

CLINICAL INEFFICIENCY

The general physiological efficiency of the laborers and other inhabitants of San José is very low, and it is believed that 50

per cent of the efficiency as compared with the normal ability of an average healthy Filipino would be a conservative estimate of conditions in this respect found in Mindoro. There are several reasons for this low state of nutrition and development in addition to that part of it which is explained by the high incidence of malaria, tuberculosis, and other diseases.

The principal factors concerned in the production of this inefficiency are the habits and customs of the people, particularly the poor quality and small amount of food consumed by the average Filipino of the working classes. The low efficiency stated is based on the general appearance of the people, their early exhaustion and inability to perform a reasonable amount of manual labor, and upon certain physical findings and a series of hæmoglobin estimates. The relation of the percentage of hæmoglobin estimates to enlarged spleens is shown in Table IX.

TABLE IX.—*Relation of the percentage of hæmoglobin estimates to enlarged spleen.*

Hæmoglobin estimates.		Cases of enlarged spleen.
Persons.	Per cent of hæmoglobin.	
91	100	13
81	90	47
71	80	78
61	70	81
51	60	32
41	50	6
31	40	2
Not recorded.....		32
		291

Examination of this table indicates that malaria as determined by enlarged spleen is not the principal factor in the reduction of hæmoglobin percentage, neither is this true with regard to tuberculosis. The condition is more far reaching and has to do, as stated above, with the poor nutrition and under development of the people as a whole.

Intimately associated with the lowered vascular tone mentioned above, either as cause or as effect, is the high incidence in malnutrition; and the results of this malnutrition, obviously, are both mechanical and toxic. The causes of malnutrition are two. First, an economic condition which makes it impossible for people of the working classes properly to nourish themselves and

their families; and, secondly, the inability properly to assimilate satisfactory food products, provided these are obtainable.

The general question of clinical inefficiency is largely an economic one, but nevertheless it is one of the most important phases of the complex problem of health and sanitation in Mindoro, as well as in other parts of the Philippine Islands.

7. A COMPARISON OF THE SPLEEN INDEX WITH THE MICROSCOPIC EXAMINATION OF THE BLOOD FOR MALARIAL PARASITES IN 1,003 PERSONS

BY ERNEST LINWOOD WALKER and SETH L. COX

There are two methods in general use for obtaining the index of malarial infection in any region. One of these is by microscopic examination of the blood of a certain portion of the inhabitants for malarial parasites; the other is by the determination by palpation of the number of the individuals having enlarged spleens. Both methods have their application and their limitations. The microscopic examination of the blood is especially applicable for determining the incidence among nonimmune persons. The advantages of this method are that it is more apt to discover recent infections and that its results are direct and unequivocal; its disadvantages and limitations are, first, the time required to make an adequate research of the blood of a sufficient number of individuals; and, secondly, the fact that the parasites cannot always be found in the peripheral blood, especially in chronic cases. The spleen index is especially applicable to the determination of the endemicity in a malarial region. It is a convenient and quick method; but it is subject to the errors that enlargement of the spleen in the tropics may be due to causes other than malaria, that it is considered reliable only when applied to children between the ages of from 1 to 10 years, and that it may not indicate recent infections in which the spleen had not yet become enlarged.

In the laboratory examinations of about one-third of the population of San José, a relatively large proportion of individuals was found to harbor malarial parasites in the blood, and in the physical examinations of these same persons a nearly equal proportion was found to have enlarged spleens. Therefore, it has seemed worth while to compare the two series in order to determine how far they coincided. This could readily be done, as the two series of examinations were made on the same persons and the individuals of each series could be identified by their company number.

Certain peculiar conditions must be taken into consideration, however, in comparing the spleen rate and the parasite rate of the inhabitants of San José.

The population of San José consists chiefly of adult males and of relatively few women and children. Consequently, both the blood examinations and the spleen palpations in these series have been made chiefly of adult males. Neither the spleen rate nor the parasite rate is considered reliable in diagnosing endemic malaria unless applied to children between the ages of 1 and 10 years.

Moreover, it is to be noted that the population of San José is for the most part not a permanent but a shifting one. The laborers of this estate are practically all imported, both from all parts of the Philippine Islands and from abroad. They are chiefly Filipinos, but include some Japanese and East Indians. A few Americans and Europeans are employed to superintend the work of the laborers and to perform the skilled work on the plantation. The Filipino laborers, for one reason or another, usually remain only for a short time at San José. After working for a few months, they return to their homes and are replaced by freshly imported men. A certain proportion of them return from time to time to be reemployed on the estate. The company estimates that 90 per cent of their laborers remains in their employ less than six months, that 9 per cent remains more than six but less than twelve months, and that 1 per cent remains more than one year.

This circumstance modifies the interpretation to be placed on the results of these examinations. The population being constantly shifting, the new arrivals, unless coming from a malarious region, would be nonimmunes. Therefore, the blood and spleen examinations of the inhabitants of San José would show not the endemic index of that region, but the incidence of infection with malaria among the more or less nonimmune adults.

Of the 1,064 persons, exclusive of those who were ill with fever, of whom microscopic examination of the blood was made, 357, or 33.55 per cent, showed malarial parasites; and of the 1,110 persons whose spleens were palpated 291, or 27.11 per cent, showed enlargement. Therefore, if the two series should coincide, approximately equal results would be obtained by the two methods of diagnosis.

Considering first the total number of persons of whom both spleen palpation and microscopic examination of the blood were made, Table X shows the spleen rate, the parasite rate, and the percentage of agreement between the two series.

TABLE X.—*The relation of splenic enlargement to malarial parasites in the blood.*

Spleen.	Malarial parasites.	Cases.	Percentage of agreement.
Palpable	+	39	} 42.29
Do	0	53	
Much enlarged	+	66	} 40.24
Do	0	93	
Total enlarged	+	105	} 41.01
Do	0	151	
Not enlarged	+	224	} 70.01
Do	0	523	

From Table X it appears that the agreement between spleen rate and the parasite rate is not very close. The percentage of agreement is greatest in those cases that showed no splenic enlargement, being 70.01 per cent; it is markedly less in those cases that show a splenic enlargement, being 41.01 per cent; and it is slightly less in those cases which have a much enlarged spleen than in those where the spleen is only palpable, being 42.24 and 42.39, respectively, in the two series. This relationship between spleen index and microscopic findings may be expressed in another way. Of 256 persons who had enlarged spleens only 105, or 41 per cent, showed malarial parasites in their blood; and of 329 persons who showed malarial parasites in their blood only 105, or 31.91 per cent, had enlarged spleens.

It is true that 50 of the persons who had enlarged spleens but in whose blood malarial parasites were not found gave a history of attacks of malaria within a year, and it is probable that others, who gave no history of malaria, had suffered from previous attacks of malaria. It is further probable that some of the persons who were negative microscopically for malaria were nevertheless infected. Taking these facts into consideration, the percentage of agreement between those who had enlarged spleens and those who were or had previously been infected with malaria would be increased.

Since both the spleen rate and the parasite rate are generally considered to be more trustworthy when applied to children between the ages of 1 and 10 years, it is of interest to compare the two methods of diagnosis in these patients grouped according to ages. For reasons previously stated, the majority of these people were adult males; therefore, the number of children between the ages of 1 and 10 years included in these examinations is small.

TABLE XI.—Relation of splenic enlargement to the presence of malarial parasites in the blood in persons grouped according to age.

Age.	Parasites.		Spleen.			Percent- age of agree- ment.
	Infec- tion.	Cases.	Much en- larged.	Palpa- ble.	Not en- larged.	
			Cases.	Cases.	Cases.	
1 to 10 years -----	{ +	11	7	1	3	72.70
	{ 0	16	3	2	11	68.75
11 to 20 years -----	{ +	163	40	17	106	34.96
	{ 0	275	46	18	211	76.72
21 to 30 years -----	{ +	113	17	18	78	30.97
	{ 0	254	35	23	196	77.16
31 to 40 years -----	{ +	21	2	2	17	19.04
	{ 0	82	9	7	66	70.48
41 to 50 years -----	{ +	1 ²			12	
	{ 0	29	3	2	24	32.75
51 to 60 years -----	{ +	5			5	
	{ 0	11	2		9	81.81
61 to 70 years -----	{ +	0				
	{ 0	2			2	100.00
71 to 80 years -----	{ +	0				
	{ 0	1		1		100.00
Age unknown -----	{ +	4		1	3	25.00
	{ 0	4			4	100.00

From Table XI it appears that the percentage of agreement between parasite rate and spleen rate in those persons who showed malarial parasites in the blood is greatest between the ages of 1 and 10 years and constantly decreases in the older age groups; while, on the other hand, the percentage of agreement in those persons who were negative for malarial parasites is lowest in the age group of from 1 to 10 years and progressively increases in the older age groups. Nevertheless, the percentage of total agreement between the spleen rate and the parasite rate is greater in children than in adults.

Therefore, the results of this comparison of the spleen index and microscopic examination of the blood for malarial parasites indicate that, under the conditions of this investigation, the microscopic examination of the blood is the more reliable method of determining the incidence of infection, first, because more cases were discovered by this method; and, secondly, because the microscopic diagnoses of the positive cases are unequivocal. These conclusions are applied only to the determination of the incidence of malarial infection at San José and not to the endemic index.

8. SUMMARY AND CONCLUSIONS

The following extract from the preliminary report of the commission is a brief summary of the health conditions of the west coast of Mindoro, with the important recommendations for their improvement.

STATEMENT OF CONDITIONS

The sanitary problems of the Mindoro properties are a part of, and inseparable from, similar problems of the municipality of Pandorocan and the whole west coast of Mindoro. The municipality has a population of some 5,500 people, of which about 3,200 are employees or otherwise inhabitants of the camps of the corporation located at San José.

Both the sanitary and the social and economic problems must be solved by experimentation, because pioneer work is required under conditions which have no precedent. To give an idea of the magnitude of these problems, it is only necessary to state that they are equal to, or greater than, those encountered in the construction of the Panama Canal.

The San José interests have an area of between 210 and 260 square kilometers of territory, which is bounded on the east by the mountains of Mindoro, the inhabitants of which are wild men who appear to be very extensively infected with malaria. The property is continuous along the coast line with a number of the most insanitary barrios, whose inhabitants are very extensively infected with malaria, tuberculosis, hookworms, and other tropical diseases. In the Canal Zone, with a slightly larger geographical area than the San José Estate, all efforts are centered on the digging of the canal, while in San José the naturally more complex problem is amplified, because of efforts to cultivate the land with irrigation. Finally, very unwise administration in the early part of the development work of this location has added materially to the amount of infection, particularly malaria, which must be eradicated before satisfactory health conditions can be established.

The studies of the commission may be briefly summarized as follows:

The incidence of malaria among the inhabitants of San José is approximately 35 per cent of the total population, and this infection is kept up by recurrence in old malaria cases and by constant introduction of new cases from without and from outlying camps and by new infections among the inhabitants of San José.

The incidence of tuberculosis is about 30 per cent; hookworm infection from 45 to 50 per cent; clinical anæmia about 90 per cent; with a large share of other less important diseases and conditions.

Most important of all, the physiological efficiency of the employees and the inhabitants of San José may be comparatively estimated at 50 per cent, using as a basis for this calculation the normal efficiency of the average healthy Filipino.

The social and economic conditions of the inhabitants of San José are not as satisfactory as they should be. The opinion is advanced that the barrack system of housing employees and their families is a mistake in the tropics among tropical races, and it undoubtedly is a mistake in the absence of careful and exacting police and sanitary protection. The construction of these barracks is of a fairly satisfactory character, but under present conditions they are dirty, badly kept, and overcrowded, and show a complete absence of any attempt in the establishment of home life among the inhabitants.

The management of the kitchens and mess halls is not consistent with elementary sanitary requirements. For example, one kitchen within 60 meters of the hospital contains myriads of flies; it is dirty; and it is used as a storeroom for food and for the soiled clothing of the cooks and assistants and as a bathroom by muchachos and children. Conditions in the mess hall proper are but very little better.

The caloric value of the foodstuffs eaten by the majority of the employees, whether in the mess halls or in their own houses, is far below the minimum physiological requirement consistent with manual labor. This condition, as is well known, is general among the lower classes of Filipinos. It is one of the as yet unsolved problems of this country.

The medical department, as a whole, is doing splendid work, particularly in its mosquito-suppression work. However, with the enormous amount of malarial infection now prevalent in the camp, the methods of work now in use will not begin to meet the situation during the rainy season with the consequent increase in the number of mosquitoes. The entomologic survey shows that the inhabited portion of the properties is very well policed regarding mosquitoes, but on all sides just without this zone are innumerable breeding places filled with anopheline mosquitoes. With the advent of the rainy season, it will be impossible to maintain the present mosquito-free zone without the expenditure of an unreasonable sum of money.

9. RECOMMENDATIONS

Successfully to cope with the sanitary problem connected with the Mindoro properties demands a definite organization of a sanitary department with its personnel, equipment, and supplies; the delegation of a definite authority; and sufficient appropriation to carry on the work. The head of this department, whether he be an employee of the company or of the Government or of both, unquestionably should have the authority and perform the duties of a district health officer, not only for the Mindoro properties but for all outlying barrios. This department should direct its efforts along the following lines:

1. The prevention of reinfection by the importation of malaria-free laborers and by restricting the intercourse between the inhabitants of the protected zone and infected persons in near-by territory.
2. Efficient hospitalization for sick people.
3. Satisfactory free dispensary service for those who are not ill enough to require hospital care.
4. A visiting service for the location of carriers and other infected persons.
5. The systematic treatment of all persons (compulsory if necessary) harboring the malarial parasite.
6. Constant application of approved methods for the reduction of anopheline mosquitoes.
7. A sanitary corps whose duties should be the cleaning up of new camps before such camps are occupied by laborers.
8. Supervision of the housing and feeding of employees, their families, and all other inhabitants of the zone.
9. Carefully planned and systematic reports from all divisions of this department.

As is well known, the propagation of malaria depends upon the integrity of a three-link chain, and the breaking of any link or the reduction in the strength of all three links embodies the whole principle in combating this infection. The three links are:

1. The infected person.
2. The proper variety of anopheline mosquitoes.
3. The nonimmune person.

The campaign against this infection, therefore, must be along three principal lines and along all of them at the same time:

1. The suppression, as far as possible, of the propagation of anopheline mosquitoes.
2. The protection, as far as possible, of nonimmune persons from mosquito bites, particularly at night.
3. Most important of all, the prevention of the introduction of new cases from without and the thorough treatment of all infected cases whether new or recurrent, within the inhabited zone, together with the protection

of these persons during their period of infection against the bites of malaria-carrying mosquitoes.

Every case of malaria that applies for treatment and every case that can be found in quarters or in the field should be treated actively and aggressively until the patient no longer is a carrier of the malarial parasite. The character of this treatment is a detail subject to discussion, but the main point is that it should, and if success is to be attained *must*, be carried out as indicated.

For the prevention of the introduction of malaria from without, two important things are necessary:

1. There should be arrangements for proper physical examination of all laborers at their points of embarkation and before their services are accepted by the company.
2. Communication with the badly infected barrios adjacent to the property must cease, and in the enforcement of this phase of the question generous Government support will be necessary. As will be indicated in the final report of the commission, a number of these barrios should be transferred to more healthful locations, and aggressive and persistent municipal effort should be employed in cleaning up the other infected places.

SANITARY DEPARTMENT

The following outline of a sanitary department was recommended by the commission and, in part, has been placed in operation by the directorate of the Mindoro properties:

Chief physician.—Directly responsible to the manager. To be in general charge of all sanitary matters, including the administration of hospital, dispensary, mosquito suppression, general camp sanitation, and supervision over water supply, food supply, etc. All employees of the sanitary department to be subject to the chief physician.

Superintendent.—Directly responsible to the chief physician. His duties should be as follows: Administrator—in charge of records, property, employees, cooks, commissary, etc.

There should be one bookkeeper, two clerks, one cook, and as many muchachos as the work calls for.

Chief nurse.—Directly responsible to the chief physician. To be in charge of housekeeping, hospital, dispensary, nurses, nurses' home, employees' quarters, kitchen, commissary, and linen. Two female and two male nurses would be required on the staff.

Resident physician.—Directly responsible to the chief physician. His duties to consist in professional work of hospital and dispensary.

Visiting physician.—Directly responsible to the chief phy-

sician. To visit officials and families, employees sick in quarters, and all sick persons. In charge of mosquito brigade and sanitary corps.

Chief sanitary inspector.—Directly responsible to the visiting physician. To have charge of the carrying out of all rules relating to general sanitation. Five sanitary inspectors should assist him in the performance of his duties.

Because the work of the sanitary department is so comprehensive and the work to be done is of such magnitude and so urgent, it is recommended that the chief physician organize his department into four individual divisions, namely: (a) Administration division; (b) hospital and dispensary; (c) mosquito-suppression division; and (d) sanitary division.

Administration division.—This should be in immediate charge of the superintendent of the hospital, and should consist in the institution and maintenance of a satisfactory system of records, professional as well as those of accountability of property, etc.; these records, of course, to include the preparation of the necessary pay roll, requisitions, receipts, etc. connected with the running of the department. It should have charge of the general questions of employees, housing, property, supplies, commissaries, mess hall, cooks, kitchens, and dormitories for attendants. The superintendent must, of course, have the necessary book-keeper, clerks, and other employees for the proper administration of the division.

Hospital and dispensary.—This division should be directly under the resident physician for his professional work, the chief nurse for her professional work, and the superintendent for the administrative work—all these three, in turn, being responsible to the chief physician. The division of the sanitary department needs some strengthening in personnel, as is indicated above, and its duties should be increased successfully to care for all sick people of the community. It is not possible to conduct this division with any degree of efficiency under the present construction and arrangement of the hospital. A rough sketch outline of suggested additions to the hospital has been furnished. The committee is fully aware of the fact that additional construction is expensive, but the most important condition to be met in Mindoro at the present time is to get rid of as much of the malaria now there as is possible. To do this will require expansion of the hospital, the establishment of a fairly large free dispensary service, and good coöperative work on the part of the sanitary department. With increased hospital space and increased personnel, the hospital days of the average

case of malaria should be reduced from two to four days, the patients, of course, being required to come to the free dispensary daily, every other day, or twice a week, as the case may be, for subsequent treatment until the disease has been completely eradicated.

Mosquito-suppression division.—This division should be immediately under the direction of the visiting physician who, in turn, is responsible to the chief physician.

Mosquito-suppression measures of economy and of approved value should be carried out by the chief mosquito inspector and such additional employees as are necessary. Modification and method of procedure in this division as well as in all others should be indicated by written circulars of instruction from the chief of the department. Such detailed rules and regulations as will insure daily inspection of breeding places of mosquitoes, location of infected mosquitoes, infected patients, etc. should be made very explicit and be very rigidly enforced. This division of the work in San José is already in a very satisfactory condition. The chief mosquito inspector might well be a male trained nurse who has had special instruction in this branch of work.

The mosquito-suppression division and the sanitary division should be the advance guard in opening any new camp or new spot of civilization or in any other method of extension of the activities of the company.

The sanitary division.—This division is a very important one. The chief sanitary inspector should be a male trained nurse who has had special instruction in general sanitary work. He should be directly responsible to the visiting physician and have such additional help as may be necessary. He should inspect daily every habitation and every camp and report on every case of illness, particularly persons suffering with fever and requiring hospital or free dispensary attendance. He should see that sleeping quarters are not overcrowded, are kept with at least a semblance of cleanliness, and that they are properly ventilated. He should enforce rules regarding the distribution and use of water; the collection and disposal of sewage and garbage; should locate and destroy the breeding places of flies; and should carefully inspect and control the sanitary condition particularly of kitchens, mess halls, and other places where food refuse of any kind is apt to accumulate.

It hardly seems necessary to indicate further the numerous minor details connected with the efficient administration of these two divisions.

The above outlined organization will give a unit that should be sufficient to meet the requirements of the situation, provided the necessary governmental coöperation can be secured in controlling the external problem. Recommendations covering this phase of the subject are that:

1. The municipal government of Pandorocan be moved to Santa Teresa.
2. The barrio of Mangarin be transferred to Santa Teresa.
3. The chief physician of the San José Estate be given the official designation and authority of a district health officer.
4. On account of the increasing incidence of malaria fever in various parts of the Philippine Islands, the Director of Health be requested to declare malaria a dangerous communicable disease within the meaning of the law, in order that the usual methods of eradication may be enforced when necessary.
5. The Government make arrangements, either by conferring authority upon the officers of the San José Estate or otherwise, to provide satisfactory police and legal protection for the inhabitants of Pandorocan.

10. APPENDIX

The following series of questions submitted in letters addressed to the attorney and chief physician, respectively, of the Mindoro properties, together with the answers to these questions, are so important in understanding the social, sanitary, and economic problems of Mindoro that they are given in full:

1. What was the average population during the years 1911 and 1912; separate figures for men, women, and children?

The Mindoro Company: No census was kept during the years 1911 and 1912.

San José Estate: 1911, men about 2,000. Very few women and children here this year; 1912, men about 2,200, women about 200, and children 150.

2. The average number of laborers on your pay rolls during the above period?

The Mindoro Company: 628 per month.

San José Estate: 1911, about 500; 1912, about 2,000.

3. The average number of days worked per month by these employees?

The Mindoro Company: Sixteen days.

San José Estate: 1911, about fifteen days; 1912, about seventeen.

4. Average weekly income per person based upon the total adult male population?

The Mindoro Company: 5.14 pesos.

San José Estate: Population too variable to give this as asked, but the average weekly income for the worker in 1911 was 3.85 pesos and in 1912 4.50 pesos.

5. Average daily wage for unskilled labor; average daily wage for skilled labor; what percentage of employees are classed as skilled labor?

The Mindoro Company: The average daily amount actually earned per man on roll was 73.5 centavos. About one-third of all employees on rolls were skilled workmen.

The San José Estate: In 1911 the labor was practically unskilled and the average daily wage was 51 centavos. In 1912 we had about 10 per cent skilled labor, the average wage for which was about 1.80 pesos; for unskilled labor it is about 60 centavos per day.

6. What percentage of your employees remains in your employ for less than six months? What percentage for more than six months and less than one year? What percentage remains more than one year?

The Mindoro Company: No reliable data available.

San José Estate: 90 per cent; 9 per cent; 1 per cent.

7. What was the total number of new employees engaged during the years 1911 and 1912, by years?

The Mindoro Company: No reliable data available.

The San José Estate: Approximately 1,800 each year.

8. What was the total number of employees leaving your service during the same period of time?

The Mindoro Company: No reliable data available.

San José Estate: About 125 a month.

9. What percentage of the wages of unskilled labor is paid back to the company: (a) For food, (b) for rent, (c) for water, (d) for light, (e) for all other purposes?

The Mindoro Company: No reliable data available. During the years 1911 and 1912 the Mindoro Company operated a store which catered to the employees of the San José Estate, Mindoro Company, and Manila Construction Company. The last company employed some 300 men in construction work on the sugar mill from July to December, 1911, who were not carried on the estate or company rolls. The store not only handled foodstuff, but clothing and household necessities; therefore, any attempt to give figures on money paid back for the specific commodities would be idle guess work. No charge was made for water or houses.

San José Estate: (a) about 25 per cent; (b) none; (c) none; (d) about 3 per cent; (e) none.

10. Approximately what percentage of the wages paid unskilled labor do you estimate as being paid to private tiendas?

The Mindoro Company: It is estimated that considerably less than 10 per cent was paid to private tiendas.

San José Estate: About 10 per cent.

11. Based upon the sales through the company's stores and agents, what would you consider the average daily money value of subsistence per capita for the total population, including men, women, and children?

The Mindoro Company: Owing to the absence of census figures and as no store record along these lines was kept, it is impossible even to approximate daily money value of subsistence per capita of total population.

San José Estate: For adults about 25 centavos per day.

12. Is the quality of rice (red and white rice) purchased optional with inhabitants, and approximately what percentage of the quality of this staple article of food is used and what is the average price of each?

The Mindoro Company: Nothing but white rice was sold in store at an average price of 35 centavos per ganta.

San José Estate: Optional. The prices are graded according to prices ruling the rice market in Manila.

13. What is the average price at which fish is sold?

The Mindoro Company: 35 centavos per kilogram.

San José Estate: 40 centavos a kilogram in the store. In the private tiendas, when fish is scarce, the natives, unless very closely watched, will run the price up to any figure they can get.

14. Is the supply of green vegetables kept as complete as consistent with the market, and how do the prices compare, for these articles, with prices for similar articles in Manila and other parts of the Islands?

The Mindoro Company: Green vegetables were handled when possible and sold at practically Manila prices.

San José Estate: Yes, about the same as throughout the provinces.

15. What class of fuel is used by the majority of your unskilled labor; what is the source and what price is paid?

The Mindoro Company: The fuel used consists mainly of scrap lumber for which no charge is made by the company.

San José Estate: Coal and wood free, picked up about the place.

16. What is the average expense for each unskilled laborer up to the time he begins work?

The Mindoro Company: Each laborer costs the Company approximately 10 pesos to land on premises.

San José Estate: About 13 pesos.

17. What precautions are taken to avoid the introduction of the various contagious diseases with the importation of new laborers?

The Mindoro Company: No medical examination was made of new laborers up to the first of the year.

San José Estate: None.

18. What are your age-limit requirements, minor and major?

The Mindoro Company: No age limit was observed up to the first of the year.

San José Estate: None.

19. Approximately how much was spent for sanitary improvement including personnel, equipment, supplies, mosquito brigade, etc. during the year 1911 and during the year 1912, and what is your monthly expense at the present time?

The Mindoro Company: Approximately 40,000 pesos were expended in sanitary work during 1911 and 1912, exclusive of the hospital equipment and maintenance. About 2,000 pesos are expended per month at the present time for sanitary work, exclusive of hospital expenses.

San José Estate: From the beginning of the San José Estate, April, 1911, to December of the same year, over 7,000 pesos were expended. For the year 1912, over 65,000 pesos were expended. At the present time the average monthly expense is 3,500 pesos.

20. Please itemize your present monthly sanitary expenses under the following headings with such additions as you deem advisable: (a) Salaries and wages; (b) equipment and supplies; (c) construction; (d) medicine, dressing, etc.; (e) subsistence; (f) miscellaneous.

In this connection, I should like to have a list of your personnel connected with the sanitary department, with salaries and wages of all employees except those of unskilled labor.

Mindoro Company: The sanitary and hospital work is at present performed by the San José Estate force.

San José Estate: (a) Salaries and wages about 3,500 pesos. (b) Equipment and supplies about 150 pesos. (c) Construction referred to the Mindoro Company under whose auspices this work is carried on. (d) Medicines, dressing, etc. It is not possible to answer this question as these goods are bought in large quantities and it is difficult to say how much is used per month. (e) Subsistence about 450 pesos per month. (f) Miscellaneous expenses amount to 38 pesos per month. Appended is a list of the personnel with their salaries: Physician etc., 850 pesos; nurses, 300 pesos; attendants, 363 pesos; sanitarians, mosquito chasers, etc., 623 pesos; miscellaneous, 120 pesos. The difference between these figures and the 3,500 pesos quoted above is paid to the police, the workers on the incinerator, and the daily labor employed in cleaning camp and performing various duties of a like nature.

21. What charges, if any, are made against employees for medical and hospital attention: (a) For skilled labor, (b) for unskilled labor?

The Mindoro Company: No charges are made against workmen for hospital and medical attendance.

San José Estate: No charges are made to either skilled or unskilled labor, and time goes on during accident.

22. Is the time lost on account of illness a charge against the employee or against the company, and, in the latter event, during what period of time does the company continue to pay wages when the employees are ill?

The Mindoro Company: All laborers are on a daily basis, and are paid for actual work performed.

San José Estate: Time lost from accidents in the company's service is paid by the company.

23. What charges, if any, are made for professional and hospital attendance of the families of the employees: (a) Of skilled labor, (b) of unskilled labor?

The Mindoro Company: No charge is made for hospital or medical attendance in the cases of family of employee.

San José Estate: None.

24. Is medical attendance for employees reported absent on account of illness compulsory, and what methods for investigating such reported illness are in practice?

The Mindoro Company: Medical attendance for employees absent on account of reported illness is not compulsory.

San José Estate: Yes. The camps are visited daily by police and sanitarians, and all cases are reported to the medical authorities and treated either at home or in hospital as the judgment of the doctor in charge directs.

25. What methods are employed for the supervision of sleeping and residence accommodations of employees (with particular reference to the prevention of overcrowding)?

The Mindoro Company: This service is at present performed by the San José Estate.

San José Estate: The same course of instruction as outlined in answer to question 24, but, in spite of all precautions, the natives will overcrowd and it is almost impossible to stop them from doing so.

26. What regulations are in force regarding the importation and sale of (a) alcoholic beverages, (b) patent medicines?

The Mindoro Company: No regulations are in force regulating importation of alcoholic drinks or patent medicines. Beer and native wines are sold at the San José store only.

San José Estate: (a) Open market. (b) Not kept on the place.

27. What methods, if any, are employed to improve sanitary conditions along educational lines? Is there any school system available for the children of the community?

The Mindoro Company: See answer to question 20.

San José Estate: None. School building but no teacher.

28. What is the nature of available facilities for religious worship?

Mindoro Company: There are no facilities for religious worship.

San José Estate: The padre of Caguray makes periodical visits.

29. What are the available forms and customs regarding recreation and amusement?

The Mindoro Company: The company has a baseball diamond, tennis court, and moving picture show available to all.

San José Estate: Cockpit and dance hall for the natives.

30. What requirements and provisions regarding the collection and the disposal of sewage and garbage, and what methods are employed to enforce the regulations?

The Mindoro Company: See answer to question 20.

San José Estate: Garbage cans are placed at each house, and the contents are emptied daily by carts and burned. Violation of any sanitary law is punished by heavy fine.

31. In your opinion, what are the causes for the high morbidity rate of the employees of your corporation?

The Mindoro Company: Referred to Mr. George H. Fairchild.

San José Estate: As it is very probable that the diseases responsible for the high rate of morbidity here were in a large measure brought to this place, it seems to me that an inquiry into the sanitary condition of the places where these natives come from would best answer this question.

32. What recommendations, if any, have you to suggest to the commission that if embodied in this report would be of assistance to you in improving sanitary conditions?

The Mindoro Company: Referred to Mr. George H. Fairchild.

San José Estate: Remove the surrounding sources of infection, such as Mangarin.

ILLUSTRATIONS

PLATE I

Mangarin and San José, Mindoro, showing areas found to be infested by *Myzomyia rossii* Giles. Crosses in red indicate actual breeding place of *Myzomyia rossii*. Area inclosed in solid red line indicates region practically free from breeding places of this mosquito. Area inclosed between dotted red lines and coast line is that which from its appearance seemed favorable to mosquito breeding. The most dangerous area lies at present along the railroad.

TEXT FIGURES

- FIG. 1. Mindoro Island, showing the location of San José Estate.
2. The townsite of San José Estate, Mindoro.

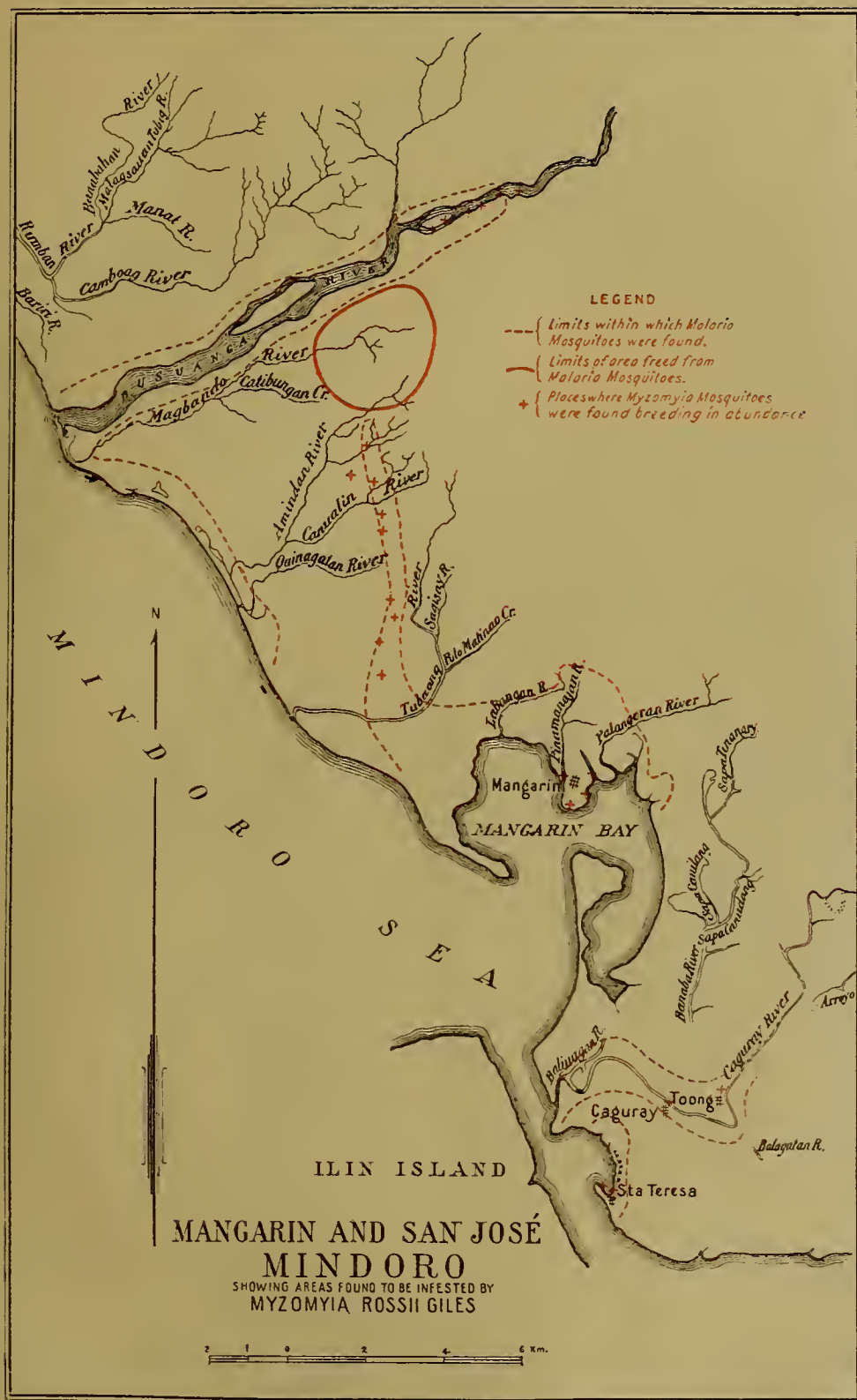

PLATE I. Mangarin and San José, Mindoro, showing areas found to be infested by *Myzomyia rossii* Giles.

**PUBLICATIONS FOR SALE BY THE BUREAU OF SCIENCE,
MANILA, PHILIPPINE ISLANDS—Continued.**

ENTOMOLOGY

A GUIDE TO BEETLES

BY HARRY J. HENNING.

Price, 25c. 112 pages, 4 1/2 inches, 7 1/2 inches.

This is a practical guide to the identification of the most common beetles of the Philippines. It contains 1,000 illustrations of the most common species, and is a valuable reference work for all those interested in the study of the insects of the Philippine Islands.

THE ECONOMIC FAUNA OF THE PHILIPPINE ISLANDS

Price, 50c. 112 pages, 4 1/2 inches, 7 1/2 inches.

This is a practical guide to the identification of the most common economic fauna of the Philippine Islands. It contains 1,000 illustrations of the most common species, and is a valuable reference work for all those interested in the study of the economic fauna of the Philippine Islands.

GENERAL SCIENCE

THE SCIENCE OF THE SOIL

Price, 25c. 112 pages, 4 1/2 inches, 7 1/2 inches.

This is a practical guide to the identification of the most common soil types of the Philippine Islands. It contains 1,000 illustrations of the most common species, and is a valuable reference work for all those interested in the study of the soil of the Philippine Islands.

ZOOLOGY

A GUIDE TO THE MAMMALS OF THE PHILIPPINE ISLANDS

Price, 25c. 112 pages, 4 1/2 inches, 7 1/2 inches.

This is a practical guide to the identification of the most common mammals of the Philippine Islands. It contains 1,000 illustrations of the most common species, and is a valuable reference work for all those interested in the study of the mammals of the Philippine Islands.

MINERALOGY—Continued.

A MANUAL OF MINERALOGY

Price, 50c. 112 pages, 4 1/2 inches, 7 1/2 inches.

This is a practical guide to the identification of the most common minerals of the Philippine Islands. It contains 1,000 illustrations of the most common species, and is a valuable reference work for all those interested in the study of the minerals of the Philippine Islands.

A DIRECTORY OF PHILIPPINE MINERALS

Price, 25c. 112 pages, 4 1/2 inches, 7 1/2 inches.

This is a practical guide to the identification of the most common minerals of the Philippine Islands. It contains 1,000 illustrations of the most common species, and is a valuable reference work for all those interested in the study of the minerals of the Philippine Islands.

MINERALOGY

REPORT OF THE INTERNATIONAL MINERALOGICAL CONGRESS

Price, 25c. 112 pages, 4 1/2 inches, 7 1/2 inches.

This is a practical guide to the identification of the most common minerals of the Philippine Islands. It contains 1,000 illustrations of the most common species, and is a valuable reference work for all those interested in the study of the minerals of the Philippine Islands.

Price, 25c. 112 pages, 4 1/2 inches, 7 1/2 inches.

This is a practical guide to the identification of the most common minerals of the Philippine Islands. It contains 1,000 illustrations of the most common species, and is a valuable reference work for all those interested in the study of the minerals of the Philippine Islands.

Price, 25c. 112 pages, 4 1/2 inches, 7 1/2 inches.

This is a practical guide to the identification of the most common minerals of the Philippine Islands. It contains 1,000 illustrations of the most common species, and is a valuable reference work for all those interested in the study of the minerals of the Philippine Islands.

BOOKS ARE IN UNITED STATES CURRENCY

Orders for these publications may be sent to the **BUREAU OF SCIENCE, PHILIPPINE ISLANDS, BUREAU OF SCIENCE, MANILA, P. I.** or to the **UNITED STATES GOVERNMENT PRINTING OFFICE, WASHINGTON, D. C.**

The **Manila Free Press**, 1000 1/2 Street, New York, U. S. A.
 The **Manila Free Press**, 1000 1/2 Street, New York, U. S. A.
 The **Manila Free Press**, 1000 1/2 Street, New York, U. S. A.
 The **Manila Free Press**, 1000 1/2 Street, New York, U. S. A.
 The **Manila Free Press**, 1000 1/2 Street, New York, U. S. A.

PUBLICATIONS FOR SALE BY THE BUREAU OF SCIENCE,
MANILA, PHILIPPINE ISLANDS

ETHNOLOGY

A VOCABULARY OF THE IGOROT LANGUAGE AS SPOKE BY THE BONTOC IGOROTS

By WALTER CLAYTON CLAPP

Order No. 404. Paper, 89 pages, \$0.75, postpaid.

The vocabulary is given in Igorot-English and English-Igorot.

THE BAKALOI DIALECT

By ORIN JENNINGS

THE BAKALOI OF PALAWAN

By EDWARD F. WILSON

Order No. 403. Paper, \$0.50; half morocco, \$0.75; postpaid.

The Bakaloi Dialect (63 pages, 25 plates) and the Details of Palawan (7 pages, 6 plates) are bound under one cover.

THE BAYAN DIALECT AS A BRANCH OF THE BUKIDNON GROUP OF LANGUAGES

By ORIN JENNINGS

THE BAYAN DIALECT AS PHILIPPINE LANGUAGES

By EDWARD F. WILSON

Order No. 407.

These two papers are bound under one cover. 142 pages, paper, \$0.50; postpaid.

THE SUBARANS OF MINDANAO BAY

By EDWARD F. WILSON

Order No. 400. Paper, 131 pages, 1 plate, 20 plates, \$1.25, postpaid.

Contains the ethnology of the modern coast of Zamboanga Province. The ethnology of the interior is treated by Mr. Carrillo under two columns of text and six plates.

The 22 pages ethnology for Davao is at work and at May; four ethnology, three plates and illustrations; and the results of the study.

THE HISTORY OF SULU

By MARION M. GARDNER

Order No. 405. Paper, 175 pages, 4 maps, 2 diagrams, \$0.75, postpaid.

In the chronicles of his ancestors for the History of Sulu, Gardner contains some valuable information and gives a general account of the history of the island. The book is a history of the Malay in the Philippines from the earliest times to the American occupation.

ETHNOLOGY—Continued

STUDIES IN MORO HISTORY, LAW, AND RELIGION

By NAJIB M. CALIBY

Order No. 405. Paper, 107 pages, 16 plates, 5 diagrams, \$0.25; half morocco, \$0.75; postpaid.

This volume deals with the earliest written records of the Moros in Mindanao. The habits of the rulers of Maguindanao are recorded in five folding diagrams.

NEORITIC OF ZAMBALES

By WILLIAM ALVA RICE

Order No. 402. Paper, 83 pages, 62 plates, \$0.25; half morocco, \$0.75; postpaid.

Plates from photographs, many of which were taken by the author, show ornaments, beads, etc., made by the writer, and also the various types of the neoritic ornaments.

INDO-CHINA

PHILIPPINE RACE

By J. J. JENNINGS

Order No. 411. Paper, 46 pages, 8 plates, \$0.50; postpaid.

This volume is a complete record of the latest and most reliable condition of the working of the Philippine race.

THE SOCIAL INDUSTRY IN THE ISLAND OF ZAMBALES

By EDWARD F. WILSON

Order No. 412. Paper, 147 pages, 10 plates, 1 map, \$1.25, postpaid.

Contains the ethnology of Zamboanga and the history of the island of Zamboanga. The ethnology of Zamboanga is one of the most important sources available for the study of the history of the island. This volume is a real contribution to the study of the history of the island and contains the conditions of work in the island.

A MANUAL OF PHILIPPINE ETHNOLOGY

By EDWARD F. WILSON

Order No. 413. Paper, 53 pages, 20 plates, \$1.25; postpaid.

A Manual of Philippine Ethnology is a book of reference for the study of the history of the Philippines. It contains a complete account of the history of the Philippines from the earliest times to the present.

THE PHILIPPINE
JOURNAL OF SCIENCE

B. TROPICAL MEDICINE

VOL. IX

JUNE, 1914

No. 3

SOME DATA CONCERNING THE MEDICAL GEOGRAPHY OF
THE PHILIPPINES ¹

By FERNANDO CALDERON

*(From the College of Medicine and Surgery, University of the Philippines,
and the Philippine General Hospital)*

The literature on the medical geography of the Philippines is very scant, and any investigator who would search in the archives and libraries for treatises concerning the demography of the different regions of the Archipelago would perhaps find an article here and there about a tropical affection and its predominance in certain localities or an essay about the diseases most frequently observed in certain regions of the Philippines, but never would he find any work which deals with the demography and sanitary condition of the Archipelago as a whole nor would he find any article on the geographic distribution of the diseases that afflict the people of the Philippines in the different regions of the Archipelago. The only work that pretends to approach the medical geography of the Philippines was written by Antonio Codorniu,² a member of the Spanish Medical Corps in these Islands, and this work is at the most not more than a tentative one on the "description of the Philippine conditions which have an influence over the human body under the special circumstances of individuality with respect to the inhabitants of the Islands." His more or less authentic observations, however, are worth repeating here. He says that—

1. The northern provinces are more healthful than those situated south of Manila, and the Visayan Islands, in spite of their being in a low latitude, are the most healthful place of all.

¹ Read before the Congress of Filipino Physicians, held in Manila, February, 1914.

² Medical Topography of the Philippine Islands. Madrid (1857).

126334

199



2. Aside from the Province of Misamis, whose salubrity can only be determined from doubtful data, Abra is the most healthful and Nueva Vizcaya is the most mortiferous of all.

3. The provinces are classified according to their health status as follows: healthful, moderately healthful, and most healthful; and under each class are mentioned the different provinces.

Later on, in 1889, José Solis³ and others edited in Manila a pamphlet written by the professors of the medical corps, and in this work the authors show that the diseases most prevalent in the Jolo Archipelago are typhoid fever, dysentery, and malaria. Other contributions worthy of mention are by Manuel Rogel Lebres⁴ and Pedro Robledo Gonzalez.⁵ The first author positively affirmed that in the Visayan provinces alone are found 10,000 lepers, while the latter asserted that the above figures represent the number of lepers in the whole Philippines in 1880, and explains the Japanese origin of the disease by the fact that in the latter part of the eighteenth century about 100 Japanese lepers who were banished by the Mikado reached Luzon and since their arrival leprosy spread rapidly all over the Islands. In the three centuries of Spanish dominion, the above are the only available data concerning the medical geography of the Philippines.

In the fifteen years of American régime, numerous and varied articles have been published about the matter.

Washburn⁶ says:

In the classification of climates based on the size and extent of masses of land, oceanic, insular and continental, the climate of the Philippine Islands is largely that of the first two cases, oceanic and insular. Nowhere is the land distant from the seacoast more than 60 miles. The moderating influences of the great bodies of sea water are therefore operative. On account of climatic influences, the climate of the Philippines is widely different from those of tropical Africa, South America and Asia in the same latitude. As a rule, the smaller the island the more equable the climate throughout the day and the year. The climate of the greater part of the Philippine Archipelago is for this reason comfortable and hygienically favorable for the treatment of many diseases.

In the temperate zone an insular, mild, or equable climate is frequently a health resort.

Observations in the Manila Observatory show that while the temperature

³ Contribución al estudio estadístico-demográfico-higiénico de Joló. Manila (1889). (Contribution to the study of vital statistics and hygiene of Jolo.)

⁴ Leprosy in the Visayan Provinces (1897).

⁵ Leprosy in the Philippines (1902).

⁶ The relation between climate and health with special reference to American occupation of the Philippine Islands. Read before the second annual meeting of the Philippine Islands Medical Association in 1904.

as indicated by the thermometer at sea level is practically the same throughout the Philippine Archipelago, it is higher in some regions than in others during the months of April, May and June which cover the periods. There exists a considerable difference in climate between the coastal regions of the islands of the Archipelago and the elevated regions of Luzon and Mindanao. Mountain climate of these two islands is similar to that in Baguio, Luzon, whose altitude is 4,777 feet and whose average temperature and humidity are relatively low during the hot months of March, April, May, and June owing to the prevailing winds blowing from the China sea during that season. The climate of this region is ideal from November to June.

The article of Jerome B. Thomas⁷ describes the principal diseases found in 1903 and 1904 among the Igorots and Ilocanos, who live in Baguio and the neighboring mountain regions. These diseases are: Beriberi in benign form, bronchitis which is most common during the months of January and February, influenza, malaria, rare cases of amœbic dysentery, gastroenteritis due to indigestion, some cases of cerebrospinal meningitis, various kinds of skin diseases, and parasitism.

In regard to the intestinal parasites, we should mention the interesting article of Garrison.⁸ This investigator examined microscopically the fæces of 4,106 inmates of Bilibid Prison of Manila, and found that 3,447, or 89 per cent, had one or more varieties of intestinal parasites. The author suggests that, although these prisoners come from all parts of the Islands, it would be interesting to make a minute investigation in the different provinces of the Archipelago and without doubt it could be demonstrated that in certain regions there is an excess of intestinal parasites. In the same year, 1908, Ross S. Rissler and Liborio Gomez presented a paper about the campaign they made against the intestinal parasites in Las Piñas and other towns of Cavite and Rizal; of 6,018 individuals they found that 5,406, or 89.84 per cent, harbored intestinal parasites. In another paper⁹ these authors, having examined the fæces of 10,000 individuals, arrived at the conclusion that parasitism is a universal affection

⁷ Notes on diseases encountered in Baguio, Benguet, P. I., and the adjacent highlands of central Luzon, including revised excerpts from the advance sheet of a report to the Secretary of the Interior. Read before the Manila Medical Society on February 6, 1905.

⁸ The prevalence and distribution of animal parasites of man in the Philippine Islands, with a consideration of their possible influence upon the public health. Read before the fifth annual meeting of the Philippine Islands Medical Association in 1908.

⁹ Prevalence of intestinal parasites in Rizal and Cavite and in Cagayan Valley. Read at the assembly of the Far Eastern Association of Tropical Medicine in Manila in March, 1910.

in the Philippines. This conclusion may seem too radical, but it is confirmed by the fact that the examination of the fæces of all the patients admitted in the obstetrical department of the Philippine General Hospital has shown that about 80 per cent of the women have intestinal parasites.

Two articles that deserve mention are Filariasis and elephantiasis in southern Luzon¹⁰ and Notes on the distribution of *Filaria nocturna* in the Philippine Islands¹¹ by Phalen and Nichols. In the first paper, the authors arrive at the conclusion that filariasis is not, as is generally believed, an uncommon affection in the Philippines; that in the Bicol provinces exists the largest focus of filariasis known with the exception, perhaps, of Davao where there is even a larger focus; and that what they reported as *Microfilaria bancrofti*, generally known as *Filaria nocturna*, is the most common form of filaria in the Philippines. In the second paper the authors show that in the valley of Kilani River in Albay Province there seems to exist an endemic center of filariasis, while the surrounding regions are not as highly infected. Probably small foci of infection may also be found in Samar, Leyte, and Mindanao.

Lastly, I shall mention the interesting article by Willets¹² in which, after describing the topography and the inadequate sanitary conditions that prevail in the Batanes Islands, north of Luzon, as well as the habits and customs of the inhabitants, he alleges that the diseases most commonly registered in that isolated region of the Archipelago are: Tuberculosis; pneumonia; pleurisy; skin diseases, especially a chronic ulcer of the thigh; rheumatism; Bright's disease; and malaria, most commonly of the pernicious type, which appears usually from July until December.

The above is all I could glean from the literature about the medical geography of the Philippines which exists in the archives and libraries I had the opportunity to examine. However, due to the kindness and spirit of coöperation of Dr. Victor G. Heiser, the Director of Health, it has been possible for me to present here the interesting vital statistics of health as written below:

The Director of Health states that, among the diseases having an important influence upon the mortality of the Philippine Islands and which science is able successfully to combat, are the following.

¹⁰ *This Journal*, Sec. B (1908), 3, 293.

¹¹ *Ibid.* (1908), 3, 305.

¹² *Ibid.* 1913), 8, 49.

BERIBERI

Beriberi, in round numbers, causes approximately 5,000 deaths per annum. There is much evidence available to show that beriberi in mothers affects the nutritive value of their milk, and this is believed to be one of the causes for *taon* among children. That the mother's milk is closely associated with the high infant mortality in the Philippines is further borne out by the fact that three times as many breast-fed infants die as bottle-fed infants, which is directly contrary to the experience in Europe and America. If it is admitted that *taon* in the child is caused by beriberi in the mother, this one disease alone is responsible for at least 25,000 deaths per annum. There is now much experimental and practical evidence that the continued consumption of white rice as a staple article of diet is responsible for beriberi. In Government institutions in the Philippines, during the time that white rice was used as a staple article of diet, there were on an average more than 600 deaths per annum; whereas, since unpolished rice has been used, there have been no deaths from beriberi in those institutions. Such evidence is further strengthened by the fact that at Culion, for instance, after the use of polished rice was again begun, beriberi appeared soon afterward and disappeared again when unpolished rice was substituted for it. In Cebu Island, where corn is the staple article of diet, there is practically no beriberi and *taon* is exceedingly rare. In Manila, on the other hand, where the use of polished rice is very common, the highest mortality from beriberi is found. Here, then, is a disease, a method of avoiding which is ready for trial, and only the coöperation of the medical profession is needed in order to bring the matter to a satisfactory test.

MALARIAL FEVER

Malarial fever is another disease which the statistics show to be responsible for at least 25,000 deaths per annum. That malaria is transmitted only by the bite of a mosquito that has previously bitten a person suffering with malarial fever is now universally admitted. Furthermore, it is well known that if quinine be promptly administered an attack of malarial fever can be avoided. Here, then, are two methods by which malaria in the Philippines could be combated: First, by eliminating the breeding places of mosquitoes; and, secondly, by the prophylactic use of quinine in communities in which malaria prevails and by the prompt treatment of those who have been infected with this disease. Geographically, malaria is most common in the follow-

ing provinces, where the death rate from this disease during 1912 was as follows: Cagayan, per 1,000 of population, 7 deaths; Oriental Negros and Ambos Camarines, each 6; and Pangasinan, Laguna, Batangas, and Ilocos Norte, each 5 deaths per 1,000. It was least common in Zambales, Surigao, and Samar, each of which had 1 death per 1,000 of population during this year. Recently, the Bureau of Health, with the approval of the Governor-General, has made arrangements for the distribution of quinine through municipal treasurers, from whom 0.3 gram quinine tablets may be obtained for 1.5 centavos¹³ each. As there are over 700 municipal treasurers in the Islands, this means that there will be 700 agencies for the more general distribution of quinine.

SMALLPOX

Smallpox is a disease that in former times was responsible for at least 40,000 deaths per annum. Since systematic vaccination has been carried on throughout the Islands, the mortality has been reduced to a comparatively few hundreds, but the necessity for constant vigilance in this disease has been most forcibly demonstrated by the events of the past two years. On account of the fact that revaccination and the vaccination of newborn children were not carried out in some of the municipalities, an outbreak of smallpox occurred which in one province alone caused over 700 deaths. One of the principal difficulties in the Philippines is to preserve the ordinary glycerinated vaccine virus, and by actual experience it has been found that it is of very doubtful value after it has been removed from an ice box for a period longer than ten days. Much experimenting has been done, and recently a powdered vaccine has been developed which it is hoped will keep for a much longer period of time, but the danger from infection is greatly increased by the use of this kind of vaccine, so that the glycerinated virus used before a week has expired since it left the ice is still the safest. A careful review of the statistics of the Philippine Islands shows that smallpox infection apparently exists everywhere in the Islands, and it will make its appearance in any community in which there are unvaccinated persons.

LEPROSY

Leprosy is a disease that has been responsible for at least 1,000 of deaths per annum and probably for the new infection of a like number of persons. Practically all of the lepers of

¹³ One centavo equals 0.005 dollar United States currency.

the Philippines have now been segregated at Culion, and new cases that appear are transferred to that colony as rapidly as practicable. Apparently the number of new cases of this disease has already been reduced to less than 700 per annum, and by persistently carrying out the policy of isolation there is much hope that in time to come this terrible scourge can be entirely eliminated from the Philippine Islands; or, at least, its ravages reduced to proportions that will compare with the more advanced countries of the world. In this connection, it is interesting to observe that, while Cebu Island has approximately one-tenth of the population of the Philippine Islands, yet it furnished over one-half the lepers that have been collected.

AMŒBIC AND BACILLARY DYSENTERIES

Amœbic and bacillary dysenteries still prevail to a very great extent in the Philippines. The latter occurs almost annually in epidemic form, and is most prevalent in those provinces in which there is a poor water supply. For instance, on Catanduanes, a small island with a population of 39,288 and which is noted for its poor water, there were several hundred deaths in 1912 from bacillary dysentery; whereas, in towns in which there is good artesian water, bacillary dysentery is becoming less and less common. This one disease alone affords most concrete proof of the necessity of improving the water supply of the Philippines, and if one active doctor in each community would constantly keep this matter before the attention of the residents no doubt great improvement could be brought about in the course of a few years. Amœbic dysentery up to comparatively recent times was believed to be a disease which mostly afflicted Americans and Europeans, but the autopsies made at the city morgue showed that 33 per cent of the persons afflicted with this disease were Filipinos. There is already much evidence accumulating, however, to show that amœbic dysentery is becoming less frequent. This is probably somewhat influenced by the improved hygiene which is taking place among the masses, making it a criminal offense to use human excrement as a fertilizer or insecticide. Owing to the fact that diagnoses can only be verified in a few isolated instances in the provinces, there are as yet no reliable data available as to the localities in which this disease is most common.

FILARIA

Another disease, which as yet has not attracted great attention in the Philippine Islands but which is of more and more importance, is filariasis. For instance, an examination of 2,629

prisoners at Bilibid showed that 402 were afflicted with filaria. The highest percentage of those affected was among the prisoners from Leyte Province, which had 35 per cent. Sorsogon follows with 31 per cent, Bohol with 27 per cent, Albay with 27 per cent, and Ambos Camarines with 24 per cent. The smallest percentage occurred among the prisoners from Pangasinan, this being 0.94 per cent; next is Pampanga, with 2 per cent; and Bataan with 3 per cent. The factors which influence these infections are not yet well understood. It is, of course, known that the disease is transmitted by mosquitoes, and probably the same measures which would succeed in eradicating malarial mosquitoes would greatly reduce the incidence of filariasis.

TYPHOID FEVER

Typhoid fever has been styled the disease of modern civilization. In the Philippines, it is becoming of more and more importance from year to year. Many positive cases, the diagnoses of which have been verified by laboratory examination, have occurred in the following provinces: Ambos Camarines, Bulacan, Cavite, Ilocos Sur, Iloilo, Mountain, Pampanga, Pangasinan, Rizal, Tayabas, La Union, and Zambales. The mortality rate from diseases like typhoid, amœbic and bacillary dysenteries, cholera, and other intestinal diseases clearly points the way to the fact that if proper disposal of human excrement could be brought about thousands upon thousands of lives could readily be saved.

TUBERCULOSIS

It is estimated that there are at least 40,000 deaths annually from tuberculosis in the Philippine Islands. General educational measures have been taken against this disease almost since the beginning of American occupation. In 1910 the Philippine Islands Antituberculosis Society was organized, and an appropriation was made by the Legislature. The Bureau of Health has established hospitals for chronic tuberculosis patients in Manila and a hospital in Baguio for incipient cases. The subject has been actively taught in the schools, and the newspapers have disseminated much useful information, but so far the desired result has not been brought about. If the Philippine Islands desires to be considered in the rank of progressive countries, a campaign much more active than that of the past must be undertaken. The best methods of combating this disease are now the same in all countries, and the success that has been had in the United States and Europe in reducing the ravages of this

disease should encourage us in the Philippine Islands to resume our efforts to bring tuberculosis under control. In a country that is blessed with an equable climate like that of the Philippines, it should be possible by a general educational campaign to bring about open-air sleeping, and this alone would no doubt prove a great factor in reducing the incidence of this disease.

This brief review of a few of the preventable diseases in the Philippine Islands shows clearly that, if modern knowledge which is already available could be successfully applied, a hundred thousand deaths in the Philippine Islands could be prevented annually. The physicians of the Philippines have a wonderful opportunity before them.

These are the data furnished by the Director of Health. But to make a more thorough investigation, I personally addressed the following questions to a great majority of the physicians located in the provinces.

- A. Which are the diseases, whether medical or surgical, that predominate in your province?
- B. In your locality which diseases predominate in certain months of the year and what are their causes?
- C. Could you indicate the local and general causes of the predominance of such disease or diseases in your district?
- D. What treatment could be practiced in your district to correct the preponderance of such affections?

Ninety-five physicians from the provinces had the kindness to respond to the questions sent to them, and I cannot let this occasion pass without expressing my profound gratitude for their coöperative spirit.

To synthesize the accumulated data as a result of the above questions, I have made a tabulation of the answers received, and I here submit to your indulgent consideration the following tables.

In Table I we can see that the three diseases which predominate in the whole Archipelago are pulmonary tuberculosis, malaria, and dysentery. It can be said that in each region, each province, each town, and even in each barrio these three affections are the most terrible diseases that afflict the Filipino race. Next in frequency and predominance are beriberi, the intestinal parasites, gastroenteritis, bronchitis, and bronchopneumonia. From Table I we can see, also, that the diseases of the different provinces of the Archipelago are identical.

There is no doubt, however, that a closer study of the medical geography of the different provinces would reveal the presence of some unknown local and typical affections that characterize

certain regions of the Archipelago. To prove this assertion, I may cite as examples, what I personally observed; namely, in Calbayog, Samar Province, the rarest clinical forms of ascariasis; in Ormoc, Leyte, a disease called *kolo-kolo* which I had not observed in any other locality; and in Jaro, Leyte, many cases of simple exophthalmic goiter in women who inhabited that mountainous district. Furthermore, we have near us in the town of Parañaque, Rizal, the disease locally known as *buvas*, or yaws, which is a common affection of the inhabitants.

If we look at Table II which condenses the answers to question B (which diseases predominate in your locality in certain months of the year and what are their causes?), we can readily see that as a whole there are no seasonal diseases in the different parts of the Archipelago, but that the same pathological entities with slight variations prevail during the entire year. The truth of this assertion, however, seems to me questionable. Nevertheless, we notice that in Ilocos Sur, Iloilo, Leyte, and Occidental Negros, and perhaps in the rest of the Archipelago, smallpox, measles, varicella, and all forms of gastrointestinal affections predominate during the hot months—February, March, April, and May—while cases of grippe and bronchitis are more numerous during the months of November, December, and January—the coldest months of the year.

The answers to questions C and D are not included in this paper, as they contribute no additional information on the causes and remedies of the known diseases in the Philippine Islands.

All agree in admitting that the wide distribution of pulmonary tuberculosis in the Philippines is due to the ignorance of the masses in questions of hygiene and that such ignorance is responsible for the overcrowding of the churches, the giving of banquets in houses where tuberculous persons have just died, the abuse of alcoholic drinks, the lack of personal cleanliness, the habit of sleeping with closed windows, the lack of care in isolating tuberculous patients, as well as that the inevitable sequelæ of poverty is the insufficient nutrition of the body. With these observations, it is clear that in combating this terrible disease there should necessarily be an energetic antituberculosis campaign along educational lines.

It is believed by the majority of thinkers that the wide distribution of malaria is due to the abundance of mosquitoes in pools and in other stagnant waters found all over the Philippines and the best remedy for this disease consists in drainage, the drying

of all marshy places, the education of the people in the use of the mosquito net, and the gratuitous distribution of quinine.

Dysentery in its bacillary and amœbic forms is the necessary consequence of the imbibition of the contaminated waters consumed by the majority of our people, and this affection may be prevented by the construction of artesian wells.

Beriberi and all forms of gastroenteritis so common in our children may be diminished by the establishment of milk stations in the provinces, and the wide spread of skin diseases among our masses may be controlled by personal cleanliness and hygienic modes of life.

The above is a brief summary of the diseases which on account of their geographical importance occupy a prominent place in the pathology of the diseases found in these Islands.

I fully appreciate the difficulty of the task of making a medical geography of any region. In civilized countries more advanced than ours, every enterprise of this nature has met with serious difficulties and many obstacles; but these difficulties are even greater in our country where the data of vital health statistics are deficient and inaccurate, as you may have observed in the tables which show that provinces have not more than two or three diseases. The reason for this is not because these provinces are more healthful than others, but because there is a lack of data in the answers received to the questions distributed all over the Islands. As long as we allow 80 per cent of our municipalities to exist without qualified physicians to direct the sanitation of the towns where the illnesses of the inhabitants are not properly diagnosed and as long as we do not succeed in establishing an efficient public-health service whose beneficial influence may extend all over the Archipelago, we can never expect the present conditions of affairs to improve, for the diagnosis in the death certificates is made by the municipal secretary or in his absence by the municipal police, and such certificates form the material available to anyone who would undertake the difficult task of writing a medical geography of the Philippines.

Let us have faith, however, in the wisdom and patriotism of our legislators, and let us hope that this condition of affairs will not last forever, but that before long we shall have a reorganization of the present sanitary system by which, by means of a correct knowledge of the true medical geography of the Philippines, we may perceive the effective diminution of the mortality in these Islands.

TABLE I.—*Geographical distribution of diseases in the Philippine Islands.*

[Very incomplete records from the reports by municipal physicians.]

- Albay: Bronchitis; cystitis; convulsion, infantile; dysentery; eclampsia; erysipelas; gastroenteritis; gonorrhœa; herpes; leucoderma; malaria; metritis; parasites, intestinal; rheumatism; scabies; scrofula; syphilis; tuberculosis, pulmonary.
- Batangas: Beriberi, infantile; bronchitis; dengue; dysentery; gastroenteritis; malaria; parasites, intestinal; tetanus, umbilical; tuberculosis, pulmonary.
- Bohol: Abscesses; arthritis, tubercular; asthma; blennorrhagia; bronchitis; chlorosis; cloriza; convulsion, infantile; cystitis; dysentery, amœbic; epilepsy; furunculosis; grippe; hæmorrhoids; malaria; rheumatism; scabies; tuberculosis, pulmonary; thrush; urethritis.
- Bulacan: Abscesses; anthrax; beriberi, acute and chronic; beriberi, infantile; bronchitis; convulsion, infantile; dysentery; erysipelas; furunculosis; gastroenteritis in children; herpes; infections, gastrointestinal; malaria; phlegmon; scabies; tuberculosis, pulmonary.
- Capiz: Abscesses; bronchitis; dengue; dysentery; furunculosis; malaria; metritis; rheumatism; tuberculosis, glandular; tuberculosis, pulmonary.
- Cavite: Beriberi; colitis; convulsion, infantile; dysentery; gastroenteritis in children; malaria; rickets; tuberculosis, pulmonary.
- Cebu: Abscesses; anæmia; beriberi; dermatosis; dysentery; eclampsia; enteritis, acute; gastroenteritis; grippe; leprosy; malaria; measles; meningitis, simple; rheumatism; smallpox; syphilis; tetanus; tuberculosis; typhoid.
- Ilocos Sur: Anæmia; anthrax; bronchitis; furunculosis; hæmorrhoids; infections, gastrointestinal; malaria; measles; parasites, intestinal; rheumatism; tuberculosis, pulmonary; varicella.
- Iloilo: Abscesses; dysentery; eclampsia; fevers, gastrointestinal; furunculosis; gastroenteritis in children; grippe; harelip; hæmorrhoids; hernia; malaria; measles; parasites, intestinal; Pott's disease; tonsillitis; tuberculosis, pulmonary.
- Isabela: Malaria.
- Jolo: Dysentery; malaria.
- Laguna: Abscesses; beriberi; bronchitis; convulsion, infantile; cysts; dysentery; eczema; gastroenteritis; gastrointestinal disorders; pleurisy; tuberculosis.
- La Union: Gastroenteritis; malaria; skin diseases; parasites, intestinal; tuberculosis.
- Leyte: Beriberi; bronchitis; convulsion, infantile; dysentery; enteritis; typhoid; gastrointestinal disorders; malaria; measles; parasites, intestinal; tuberculosis, pulmonary; ulcers.
- Mindanao: Abscesses; appendicitis; autointoxications; beriberi, adult; beriberi, infantile; dengue; dysentery, amœbic; enteritis; gastroenteritis; gonorrhœa; grippe; hydrocele; malaria; parasites, intestinal; phlegmon; rheumatism; skin diseases; syphilis; tabes dorsalis; tuberculosis, pulmonary; typhoid; yaws.
- Mindoro: Abscesses; bronchitis; dysentery; hæmorrhoids; hydrocele; malaria; measles.
- Nueva Ecija: Cancer; malaria; rheumatism; tuberculosis.

- Nueva Vizcaya: Abscesses; bronchitis, acute; convulsion, infantile; furunculosis; malaria; rheumatism; tuberculosis, pulmonary.
- Occidental Negros: Congestion, pulmonary; coryza; debility, congenital; dysentery; gastroenteritis in children; malaria; parasites, intestinal; pemphigus; psoriasis (of mountain people); pulmonary diseases in children; trachoma; tuberculosis; ulcers.
- Oriental Negros: Adenitis; anæmia; blennorrhagia; bronchitis; bronchopneumonia; chlorosis; convulsion, infantile; dactylitis; dysentery, bacillary; eclampsia; epilepsy; erysipelas; epithelioma; fever, septic; fever, typhoid; fibroma; fistula; gastroenteritis; grippe; hæmatocele; hæmorrhoids; hernia, inguinal; hydrocele; hysteria; jaundice; lipoma; lupus; malaria; measles; meningitis; necrosis; nephritis; neuralgia; onychia; parasites, intestinal; polyps; rheumatism; scurvy; tetanus; tonsillitis; tuberculosis, pulmonary; ulcers.
- Palawan: Dysentery; malaria; skin diseases; tuberculosis.
- Pampanga: Abscesses; adenitis; anthrax; beriberi, infantile; bone diseases, tubercular and syphilitic; bronchitis; bronchopneumonia; calculus; convulsions; dengue; dysentery; enteritis; grippe; malaria; measles; meningitis; parasites, intestinal; rheumatism; tuberculosis, pulmonary; typhoid; varicella; yaws.
- Rizal: Anthrax; beriberi; convulsion, infantile; dysentery; enteritis; furunculosis; malaria; phlegmon; typhoid.
- Romblon: Diseases, cardiorenal; diseases, cardiovascular; dysentery; malaria; tuberculosis, pulmonary; typhoid.
- Samar: Malaria; syphilis; tuberculosis.
- Sorsogon: Anthrax; bronchitis; bronchopneumonia; convulsion, infantile; dactylitis; dysentery; enteritis; fever, typhoid; fevers, eruptive; furunculosis; gastritis; grippe; malaria; measles; phlegmon; rheumatism; septicæmia, puerperal; tuberculosis; ulcers (foot and leg); yaws.
- Tarlac: Convulsion, infantile; malaria; tuberculosis.
- Tayabas: Beriberi; bronchitis; diseases, uterine; dysentery; eclampsia, infantile; gastroenteritis; goiter, simple; herpes; malaria; pneumonia; rheumatism; tetanus, umbilical; tuberculosis; whooping cough.
- Zambales: Convulsion, infantile; dysentery, bacillary; gastroenteritis; malaria; tuberculosis.

TABLE II.—*Monthly distribution of diseases in the Philippine Islands.*

Albay:

- January: Bronchitis; eclampsia, infantile; rheumatism; tuberculosis.
- February: Bronchitis; eclampsia, infantile; rheumatism; tuberculosis.
- March: Bronchitis; dysentery; eclampsia, infantile; rheumatism; tuberculosis.
- April: Eclampsia, infantile; tuberculosis.
- May: Dysentery, epidemic; eclampsia, infantile; malaria; tuberculosis.
- June: Dysentery, epidemic; eclampsia, infantile; grippe; malaria; tuberculosis.
- July: Dysentery, epidemic; eclampsia, infantile; grippe; malaria; tuberculosis.
- August: Dysentery, epidemic; eclampsia, infantile; grippe; malaria; tuberculosis.

Albay—Continued.

September: Bronchitis; dysentery, epidemic; eclampsia, infantile; malaria; tuberculosis.

October: Bronchitis; dysentery; eclampsia, infantile; malaria; tuberculosis.

November: Bronchitis; dysentery; eclampsia, infantile; malaria; tuberculosis.

December: Dysentery; eclampsia, infantile; malaria; tuberculosis.

Batangas:

January: Beriberi, infantile; bronchitis; dengue; laryngitis.

February: Beriberi, infantile; bronchitis; dengue; laryngitis.

March: Bronchitis.

April: Gastroenteritis; parasites, intestinal.

May: Dysentery; enteritis; gastroenteritis; malaria; parasites, intestinal.

June: Dysentery; enteritis; gastroenteritis; malaria; parasites, intestinal.

July: Dysentery; enteritis; gastroenteritis; parasites, intestinal.

August: Dysentery; enteritis; malaria.

September: Malaria.

October: Malaria.

November: Beriberi, infantile; dengue; laryngitis; malaria.

December: Beriberi, infantile; bronchitis; dengue; laryngitis.

Bohol:

January: Bronchial diseases; coryza.

July: Dysentery, amœbic.

August: Dysentery, amœbic; grippe; rheumatism.

September: Grippe; rheumatism.

October: Grippe; rheumatism.

December: Bronchial diseases; coryza.

Bulacan:

January: Bronchitis; malaria; tuberculosis, pulmonary.

February: Bronchitis; malaria; tuberculosis, pulmonary.

May: Dysentery; gastroenteritis.

June: Beriberi, infantile; dysentery; gastroenteritis.

July: Beriberi, infantile; bronchitis; dysentery; gastroenteritis.

August: Beriberi, infantile; bronchitis; dysentery; gastroenteritis.

September: Beriberi; bronchitis; dysentery.

October: Beriberi; bronchitis.

November: Malaria; tuberculosis, pulmonary.

December: Bronchitis; malaria; tuberculosis, pulmonary.

Capiz.

January: Dengue; dysentery; enteritis; tuberculosis; measles; varicella.

February: Dengue; dysentery; enteritis; tuberculosis; measles; varicella.

March: Dengue; dysentery; enteritis; tuberculosis; measles; varicella.

April: Dengue; dysentery; enteritis; tuberculosis; measles; varicella.

May: Dengue; dysentery; tuberculosis; measles; varicella.

June: Dengue; dysentery; tuberculosis; measles; varicella.

July: Bronchitis; malaria; rheumatism.

August: Bronchitis; malaria; rheumatism.

Capiz—Continued.

September: Bronchitis; malaria; rheumatism.
 October: Bronchitis; malaria; rheumatism.
 November: Bronchitis; malaria; rheumatism.
 December: Bronchitis; malaria; rheumatism.

Cavite:

January: Bronchitis; malaria.
 February: Malaria.
 March: Dengue; dysentery; enteritis; tuberculosis; measles; varicella.
 April: Dengue; dysentery; enteritis; tuberculosis; measles; varicella.
 May: Dengue; dysentery; tuberculosis; measles; varicella.
 June: Dysentery; malaria.
 July: Bronchitis; malaria; rheumatism.
 August: Bronchitis; dysentery; malaria.
 September: Bronchitis; malaria; rheumatism.
 October: Dysentery; malaria.
 November: Malaria.
 December: Bronchitis; malaria.

Cebu:

January: Dysentery; enteritis, acute; fever, intermittent; meningitis, simple.
 February: Enteritis, acute; fever, intermittent; meningitis, simple.
 March: Enteritis, acute; meningitis, simple.
 April: Dengue; dysentery; enteritis; tuberculosis; measles; varicella.
 May: Dengue; dysentery; tuberculosis; measles; varicella.
 June: Dysentery; malaria.
 July: Enteritis, acute; grippe; meningitis, simple.
 August: Bronchitis; dysentery; malaria.
 September: Bronchitis; malaria; rheumatism.
 October: Enteritis, acute; meningitis, simple.
 November: Dysentery; enteritis.
 December: Bronchitis; malaria.

Ilocos Sur:

March: Measles; varicella.
 April: Measles; varicella.
 May: Dysentery; gastroenteritis.
 June: Dysentery; gastroenteritis.
 July: Dysentery; gastroenteritis.
 November: Malaria; pulmonary diseases; rheumatism.
 December: Malaria; pulmonary diseases; rheumatism.

Iloilo:

February: Measles.
 March: Measles.
 April: Measles.
 May: Dysentery; enteritis.
 June: Dysentery; enteritis.
 July: Dysentery; enteritis.
 August: Dysentery; enteritis; malaria.
 September: Dysentery; enteritis; malaria.
 October: Dysentery; enteritis; malaria.
 November: Dysentery; enteritis; malaria.
 December: Malaria.

Isabela:

January: Malaria.
February: Malaria.
March: Malaria.
April: Malaria.
May: Malaria.
June: Malaria.
July: Malaria.
August: Malaria.
September: Malaria.
October: Malaria.
November: Malaria.
December: Malaria.

Jolo:

July: Dysentery; malaria.
August: Dysentery; malaria.
September: Dysentery; malaria.
October: Dysentery; malaria.
November: Dysentery; malaria.
December: Dysentery; malaria.

Laguna:

January: Convulsions, infantile; dysentery.
February: Bronchopulmonary diseases; convulsions, infantile; dysentery.
March: Bronchopulmonary diseases; convulsions, infantile; dysentery.
April: Bronchial diseases; dysentery; malaria.
May: Bronchopulmonary disorders; dysentery; enteritis; malaria.
June: Bronchopulmonary diseases; dysentery; enteritis; malaria.
July: Bronchopulmonary diseases; dysentery; enteritis; malaria.
August: Bronchopulmonary diseases; dysentery; enteritis; malaria.
September: Bronchopulmonary diseases; convulsions, infantile; dysentery.
October: Convulsions, infantile; dysentery.
November: Convulsions, infantile; dysentery.
December: Convulsions, infantile; dysentery.

La Union:

August: Beriberi; dysentery; fevers, catarrhal; gastrointestinal disorders.
September: Beriberi; dysentery; fevers, catarrhal; gastrointestinal disorders.
October: Beriberi; dysentery; fevers, catarrhal; gastrointestinal disorders.
November: Beriberi; dysentery; fevers, catarrhal; gastrointestinal disorders.
December: Beriberi; dysentery; fevers, catarrhal; gastrointestinal disorders.

Leyte:

January: Malaria; pulmonary diseases; scabies.
February: Malaria; scabies.
March: Dysentery; measles.
April: Dysentery; measles.

Leyte—Continued.

- May: Diarrhea; dysentery; measles.
- June: Enteritis.
- July: Enteritis.
- August: Enteritis.
- November: Pulmonary diseases.
- December: Malaria; pulmonary diseases.

Mindanao:

- January: Bronchitis; dysentery; gastroenteritis; malaria; measles; rheumatism, articular; typhoid.
- February: Bronchitis; dysentery; gastroenteritis; malaria; measles; rheumatism, articular; typhoid.
- March: Bronchitis; dysentery; gastroenteritis; malaria; measles; rheumatism, articular; typhoid.
- April: Malaria.
- May: Dysentery; gastrointestinal diseases; malaria; parasites, intestinal.
- June: Dysentery, bacillary and amoebic; malaria.
- July: Dysentery, bacillary and amoebic; malaria.
- August: Dysentery, bacillary and amoebic; malaria.
- September: Dysentery; malaria.
- October: Dysentery; malaria.
- November: Dysentery; malaria.
- December: Dysentery; malaria.

Mindoro:

- January: Malaria.
- February: Malaria.
- March: Malaria.
- April: Malaria.
- May: Malaria.
- June: Malaria.
- July: Malaria.
- August: Malaria.
- September: Malaria.
- October: Malaria.
- November: Malaria.
- December: Malaria.

Nueva Ecija:

- January: Malaria.
- February: Malaria.
- March: Malaria.
- April: Malaria.
- May: Malaria; typhoid.
- June: Malaria; typhoid.
- July: Bronchopulmonary diseases; rheumatism.
- August: Bronchopulmonary diseases; rheumatism.
- September: Pulmonary diseases; rheumatism.
- October: Pulmonary diseases; rheumatism.
- November: Malaria; rheumatism.
- December: Malaria; rheumatism.

Nueva Vizcaya:

- January: Bronchitis, acute; malaria.
- February: Malaria; rheumatism, articular.
- March: Malaria; rheumatism, articular.
- August: Malaria.
- November: Bronchitis, acute; rheumatism, articular.

Occidental Negros:

- March: Gastroenteritis in children.
- April: Gastroenteritis in children.
- May: Malaria; gastroenteritis in children.
- June: Malaria.
- July: Malaria.
- August: Malaria.
- September: Malaria.
- October: Malaria.
- December: Coryza.

Oriental Negros:

- March: Dysentery; gastroenteritis; measles; smallpox; typhoid.
- April: Dysentery; gastroenteritis; measles; smallpox; typhoid.
- May: Dysentery; gastroenteritis; measles; smallpox; typhoid.
- June: Dysentery, bacillary; gastroenteritis in children; malaria.
- July: Dysentery, bacillary; gastroenteritis in children; malaria.
- August: Dysentery, bacillary; gastroenteritis in children; malaria.
- September: Dysentery, bacillary; gastroenteritis in children; malaria.
- October: Malaria.
- November: Bronchitis; dysentery; grippe; malaria; whooping cough.
- December: Bronchitis; dysentery; malaria; whooping cough.

Palawan:

- May: Malaria.
- June: Malaria.
- July: Malaria.
- August: Malaria.
- September: Malaria.

Pampanga:

- January: Malaria.
- February: Dysentery; malaria.
- March: Dysentery; measles; varicella; typhoid.
- April: Convulsions; dysentery, bacillary; malaria; measles; typhoid; varicella.
- May: Convulsions; dysentery, bacillary; malaria; measles; varicella.
- June: Bronchitis; convulsions; dysentery, bacillary; gastroenteritis; malaria; measles; varicella.
- July: Bronchitis; gastroenteritis; measles; rheumatism; varicella.
- August: Beriberi; bronchitis; gastroenteritis; rheumatism.
- September: Beriberi; rheumatism.
- October: Beriberi; malaria; rheumatism.
- November: Malaria; rheumatism.
- December: Malaria; rheumatism.

Rizal:

January: Anthrax; furunculosis; phlegmon; typhoid.
February: Anthrax; furunculosis; phlegmon; typhoid.
March: Typhoid.
April: Typhoid.
August: Dysentery; enteritis.
September: Dysentery; enteritis.
October: Dysentery; enteritis.
November: Typhoid.
December: Anthrax; furunculosis; phlegmon; typhoid.

Romblon:

January: Dysentery; measles.
February: Dysentery; measles.
March: Dysentery; measles.
October: Malaria.
November: Malaria.
December: Malaria.

Samar:

March: Tuberculosis.
April: Tuberculosis.
May: Malaria; tuberculosis.
June: Malaria; syphilis; tuberculosis.
July: Malaria; syphilis; tuberculosis.
August: Malaria; syphilis; tuberculosis.

Sorsogon:

February: Diarrhœa; dysentery; fever, typhoid; fevers, eruptive.
March: Diarrhœa; dysentery; fever, typhoid; fevers, eruptive.
April: Diarrhœa; dysentery; fever, typhoid; fevers, eruptive.
June: Bronchitis; malaria; pleurisy; pneumonia; rheumatism; tonsillitis.
July: Bronchitis; malaria; pleurisy; pneumonia; rheumatism; tonsillitis.
August: Bronchitis; malaria; pleurisy; pneumonia; rheumatism; tonsillitis.
September: Bronchitis; malaria; pleurisy; pneumonia; rheumatism; tonsillitis.
October: Bronchitis; malaria; pleurisy; pneumonia; rheumatism; tonsillitis.

Tarlac:

June: Dysentery.
July: Dysentery.
August: Dysentery.
September: Dysentery.

Tayabas:

August: Bronchitis; malaria; tuberculosis; typhoid.
September: Bronchitis; malaria; tuberculosis; typhoid.
October: Bronchitis; malaria; tuberculosis; typhoid.
November: Bronchitis; malaria; tuberculosis; typhoid.
December: Bronchitis; malaria; tuberculosis; typhoid.

Zambales:

- January: Tuberculosis.
- February: Tuberculosis.
- March: Tuberculosis.
- April: Tuberculosis.
- May: Tuberculosis.
- June: Tuberculosis.
- July: Dysentery; tuberculosis.
- August: Dysentery; tuberculosis.
- September: Tuberculosis; dysentery.
- October: Tuberculosis.
- November: Tuberculosis.
- December: Tuberculosis.

THE ETIOLOGY OF TRICHOMYCOSIS PALMELLINA IN THE PHILIPPINE ISLANDS

By OTTO SCHÖBL

(From the Biological Laboratory, Bureau of Science, Manila, P. I.)

One plate

This pathological condition of hair was first described by F. J. Pick in 1875,(1) who considered it to be of microbial origin. It is most frequently restricted to the axillary regions. The disease presents itself as a more or less marked thickening of the individual hair. In the early stage, small nodular thickenings of whitish color are to be found on the hair. In the later stage, the thickenings of the hair become confluent and a sheath, evidently of foreign matter, frequently surrounds the hair along its entire length. At this stage, it is more likely to be pigmented than in the early stage. Pasty matter can be easily scraped off the diseased hair. The hair tears easily, and its epilation is scarcely felt by the patient. Partial and temporary loss of hair in the affected region may occur. Besides the typical location in the axillary grooves, the condition has been found in the pubic region. One case of trichomycosis palmellina capilitii was observed by Winternitz.(2)

The etiology of the disease being early recognized as microbial, investigations were commenced to identify the particular microorganisms, as well as experimentally to support the theory that the bacteria found to be present on the diseased hair were the actual cause of the condition and not merely casual saprophytes as several authors had claimed. It was not until thorough bacteriological examinations were made that some light was thrown on the question.

Behrend (3) found a coccus which liquified gelatin, and formed white and yellow colonies when cultivated on agar plates. Eisner (4) describes a Gram-positive coccus which he isolated from a case of trichomycosis. As this coccus showed cultural characteristics similar to those described by Behrend, Eisner considers both microbes as identical. Similar findings were made by Sonnenberg (5) and Colombini (5) the latter author being successful in transmitting the disease. Winternitz(2) found in a case of trichomycosis palmellina capilitii a nonmotile bacillus which showed chromatic granules and formed pronounced involution forms in old cultures. The author believes his bacillus to be different from the microbe isolated from trichorhexis nodosa by Hodara and Spiegler.(6)

The disease being evidently common among Caucasians living in the Philippine Islands, it seemed of interest to compare the bacteriological findings made in Manila with those made elsewhere, particularly in temperate climates, especially as the bacteria found to be connected with the condition in question were not sufficiently classified to warrant their identification. Furthermore, it is evident from the brief outline of previous examinations that the findings made by the various authors do not refer to identical microbes. Therefore, it remains doubtful whether or not trichomycosis palmellina as a disease is of one etiology.

It is the consensus of opinion that the disease occurs more frequently in blonds than in brunets. The pigmentation of the skin seems to be of significance, as the albinos of the dark races are also susceptible. (Compare Eisner's(4) case of an albino Negro showing trichomycosis palmellina.) This rule evidently holds true also in the tropics as the disease seems to be absent among the natives. Still other factors must be taken into consideration, such as the lack of hair in the places of predilection among the Orientals, as well as the increased perspiration of the whites in the tropics as compared with the colored races of the Orient. There is no doubt that perspiration causes the seasonal occurrence and recurrence of the disease. During the cooler months or during the sojourn in a region of high altitude it was noticed that the disease was reduced to a minimum, while during the hot season the disease reached its climax, sometimes in spite of scrupulous cleanliness. In one case under observation, folliculitis with corresponding lymphadenitis was observed. Staphylococci were evidently a secondary invader in this instance.

MICROSCOPICAL EXAMINATION

The foreign matter which causes the thickening of the diseased hair was scraped off by means of a sterile scalpel. Smears were prepared therefrom and stained by the usual methods; unstained preparations were also examined. The material was found to be composed of bacteria clumped in zoöglöal masses. The great majority of the organisms were Gram-positive, non-motile, rather short bacilli of the *Corynebacterium* type; that is, rod-shaped bacteria with rounded ends, one end of the rod being thicker than the other. Elongated forms were also present. Chromatic granules were evident in smears stained with Löffler's methylene blue. Large cocci of the staphylococcic type were also found. They were more numerous in the latter stage of

the disease, while in the beginning very few were found or none at all. The cocci showed no tendency to form zoöglœa. The examination of an unstained preparation revealed no motile organisms, although Brownian movement was very pronounced.

MICROSCOPICAL EXAMINATION OF THE DISEASED HAIR IN TOTO
STAINED AND UNSTAINED

Unstained preparation.—The diseased hair was placed on a slide, suspended in a drop of salt solution, and examined microscopically under a cover glass. The foreign matter was found to be scattered along the shaft of the hair in isolated spots or in the latter stage of the disease surrounding the whole length of the shaft, but leaving always the root and, as a rule, the tip of the hair free. It consists of transparent finely granular matter, the outline of the hair being visible within the granular masses. Under high power, distinct nonmotile rod-shaped bacteria were distinguishable on the periphery of the granular aggregations.

Stained preparation.—The method of Hodara and Spiegler was employed. The hair was first treated with ether to free it from fat, then bleached with peroxide of hydrogen, and stained by Gram's method followed by counterstaining with Van Gieson's stain.

On account of the double stain, the bacteria being stained blue in contrast to the yellow-stained hair, the conditions of the hair as already described were much more conspicuous. Small groups of not over 20 bacteria could be seen scattered among the large microbial aggregations. The outside layer of the hair was split off in several places, and streaks of bacteria could be followed into the deeper layers of the hair. This anatomical change of the hair, which could be noticed on specimens untreated with chemicals, would seem to corroborate the theory that mechanical injury precedes the infection.

Repeated examinations of specimens, taken from time to time from the same patient, revealed all the stages of the pathological process under question. Small groups of bacteria could be found on the still intact cuticula of the hair, while the next focus showed defects of cuticula and bacteria penetrating in the substantia pili. In the latter stage, masses of bacteria were found in the intercellular spaces of the cortical substance. This led to splitting of the hair and to its final disintegration. It is evident that the effect of the bacterial invasion upon the hair is purely mechanical. Primarily, the bacterial growth takes place on the surface of the hair. After the cuticula has been destroyed the bacteria grow in the preformed cavities of the

substantia corticalis. Against the invasion of the bacteria the hair is defenseless, not being equipped with direct blood supply and hence lacking all means of defence against infection. The anatomical conditions of the radix pili are different from those of the shaft.(6) The cellular elements of the root of the hair being less differentiated than those of the shaft, the intercellular spaces are solid and the blood supply is nearer at hand. Hence the radix pili remains normal. Needless to say, mechanical injury of the hair followed by loss of the cuticula of the hair might facilitate the bacterial invasion, although the scalelike arrangement of the cornified cuticular cells would possibly allow the bacteria to penetrate without injury into the hair substance. At any rate, the injury might be of minimal extent to bring about the loss of the cuticula.

EXAMINATION BY CULTURES

The diseased hair was epilated by means of sterile forceps, and streak culture was made on agar plates. The cultures were incubated at 37°C. The cultural findings as compiled from repeated examinations are as follows.

Index of cultures found in cases of trichomycosis palmellina.

- I. Bacteria found constantly in any stage of every case.
 1. Small round granular colonies of *Corynebacterium*.
 2. Small umbilicated coarsely granular flat colonies, with irregular margin, of *Corynebacterium*.
- II. Bacteria found frequently:
 3. Large round homogeneous white colonies of a large micrococcus.
 4. Large round lemon-yellow-colored colonies of a large micrococcus.
- III. Bacteria found occasionally:
 5. Large white umbilicated colonies of a large micrococcus.
 6. Orange-yellow soft colonies of a small micrococcus.
 7. Round concentric olive-green colonies of *Sarcina*.
 8. Round faint yellow-colored colonies of a micrococcus.
 9. Colonies of a staphylococcus resembling *Staphylococcus aureus*.

TABLE I.—*Distribution of bacteria in the cases studied.*

Case.	Bacteria culture No.
1. O. S.	1, 2, 3, and 4.
2. J. A. J.	1, 2, 4, 5, and 9.
3. R. W. H.	1, 4, and 5.
4. McM.	1, 2, 3, 4, and 6.
5. D.	1, 3, and 7.
6. L.	1, 2, 3, and 6.
7. B.	1, 2, 3, 5, 6, and 7.
8. Jack.	1, 2, and 3.
9. Wh.	1, 3, 4, 7, and 8.
10. Gr.	1, 3, and 4.

It is evident from bacteriological examinations of ten cases of trichomycosis as summarized in the table that bacteria from the pseudodiphtheria group were found in every case to predominate over the rest of the bacterial flora. In the early stage, these organisms were present in practically pure culture. Two types of colonies were encountered, the morphology of the organisms being practically the same. The phenomenon of mutation was thought of, and great care was taken to secure pure subcultures of the two varieties of colonies. The types of colonies being indistinguishable by the naked eye in young cultures, Barber's method for isolation of a single organism was applied in order to secure guaranteed pure cultures. This method as applied to transplanting minute colonies from plates being done under the low power of the microscope, any possible contamination due to the inclusion of one colony by another could be safely avoided. I have failed to ascertain any change in the shape of colonies in pure cultures obtained in this way.

The cultures of the pseudodiphtheria group which were isolated from the cases of trichomycosis acidified glucose, maltose, and saccharose. Dextrin, inulin, galactose, mannite, raffinose, erythrite, inosite, and dulcitate remained unchanged. The acidification was very slight, and occurred after several days' incubation. Gelatin was not liquified. In bouillon, the growth occurred at the bottom of the tube in the shape of a flaky sediment. Deep agar stab culture on top of which melted agar was poured developed scanty growth. On agar slant cultures, the growth of isolated colonies was of the shape already described. Agar stab culture showed arborescent growth. No hæmolysis occurred on human blood agar. White mice survived subcutaneous inoculation of 1 cubic centimeter of a bouillon culture which was several days old.

The bacterium second in frequency found in trichomycosis was a large micrococcus forming white colonies and an organism morphologically identical with the former but forming yellow colonies (Nos. 3 and 4). These micrococci correspond to the description of the organism found by others as far as morphology and growth on the usual culture media are concerned.

The large white coccus acidified glucose, maltose, and raffinose. Mannite, dextrin, dulcitate, amygdalin, galactose, and lactose remained unchanged. The large yellow coccus acidified glucose and saccharose. The rest of the sugars mentioned above remained unchanged.

Besides the bacteria already mentioned, other chromogenic organisms were found. Their number was very limited, as a

rule two or three colonies on a plate. They are marked in the index of cultures by numbers 5, 6, 7, 8, and 9. It is more than probable that these bacteria are mere casual contaminations from the skin and play no part in the condition under question.

As the disease is so widespread among the white people in the Philippine Islands that 10 out of 11 whites picked at random showed well-developed trichomycosis, it was thought useless to attempt transmission experiments on man, on account of the objection that the person chosen for such experiment already had the disease at the time of inoculation. Indeed, at times the condition might be of such a minute extent that the hair appears to be normal, but microscopical examination, particularly that of the stained hair in toto, reveals its presence. Recourse was, therefore, had to experiments in vitro. Hairs that were found by microscopic examination to be perfectly healthy were placed in tubes of bouillon and sterilized; the tubes remained sterile after an incubation period of two days. Various cultures isolated from different cases of trichomycosis were planted in the bouillon containing the hairs and incubated at 37°C. The experiments were not successful.

The constant presence of *Corynebacterium* and its prevalence in the flora of trichomycosis palmellina in every stage of the disease, as found by repeated microscopical examination and by cultures, as well as the direct connection of these bacteria with the lesions of the diseased hair, as seen on microscopical examination of the hair in toto, leaves but little doubt that, whatever the primary "causa lesionis" may be, the above-mentioned class of bacteria, which are so widespread and so commonly found on the skin and surface mucous membranes, are responsible for the pathological condition known as trichomycosis palmellina.

REFERENCES

- (1) PICK. Vierteljahrschrift für Dermatologie und Syphilis (1876), 3, 625.
- (2) WINTERNITZ. *Arch. f. Derm. u. Syph.* (1903), 66, 81.
- (3) BEHREND. *Berl. klin. Wochenschr.* (1890), 27, 464.
- (4) EISNER. *Arch. f. Derm. u. Syph.* (1897), 41, 59.
- (5) SONNENBERG and COLOMBINI. Referred to by Winternitz (2).
- (6) SPIEGLER. *Arch. f. Derm. u. Syph.* (1897), 41, 67.
- (7) RAUBER-KOPSCH. *Lehrbuch der Anatomie.* 8 Auflage (1914).
- (8) BARBER. *Phil. Journ. Sci., Sec. B* (1914), 9.

ILLUSTRATIONS

PLATE I

- FIG. 1. Zoöglöeal masses of bacteria forming a continuous sheath surrounding the hair. Case O. S. Zeiss Ocular 4 Obj. AA.
2. The end of the hair where it was clipped off in vivo. Bacteria growing within the split hair. Case O. S. Zeiss Ocular 4 Obj. DD.
3. Cross section through the diseased hair. Bacteria penetrating within the hair. Case O. S. "Homm. immer." $\frac{1}{2}$ Ocular 2.



Fig. 1. Zooglæal masses of bacteria forming a continuous sheath surrounding a hair.



Fig. 2. Bacteria growing within the split end of a hair.

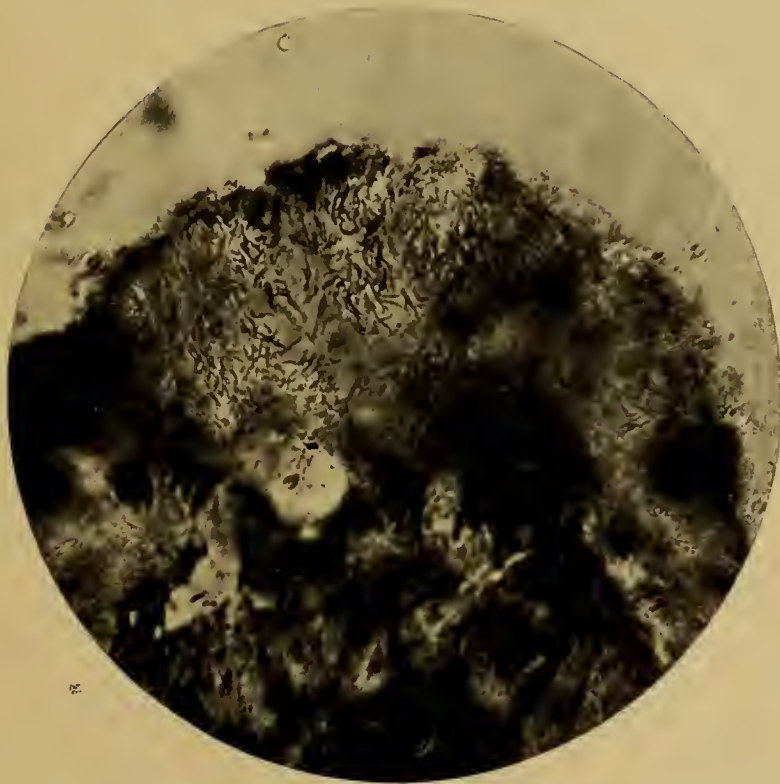

Fig. 3. Cross section through a diseased hair, showing bacteria penetrating within the hair.

PLATE I. THE ETIOLOGY OF TRICHOMYCOSIS PALMELLINA.

A CONTRIBUTION TO THE BACTERIOLOGY OF LEPROSY

PRELIMINARY NOTE

By JOHN A. JOHNSTON

(From the Biological Laboratory, Bureau of Science, Manila, P. I.)

One plate

Since Hansen (1) in 1872 announced his discovery of the specific cause of this disease, many men in different parts of the world have endeavored to cultivate *Bacillus lepræ* with varied success. Twenty-eight cultivations have been reported and cited,(2) of which 20 were organisms of the diphtheroid type, 5 were rods, and 3 were *Streptothrix*. None of these organisms has received a general recognition as the real *Bacillus lepræ*. Only two workers, Kedrowski and Bayon, report any results of animal inoculation with cultures that bear any pathological similarity to the lesions of human leprosy. Probably the earliest reported isolation was that of Bordoni-Uffreduzzi in 1888, who succeeded in growing an acid-fast diphtheroid organism. Since this date there has gradually crept into the literature, and now is apparently generally accepted, the term, acid resisting, for an organism which shows any tendency to hold stain against acids. *Bacillus lepræ*, as we find it in the tissues and juices of the body, is distinctly acid fast, although not quite so acid fast as the tubercle bacillus; but to term a bacillus, which, after staining by carbol fuchsin, readily decolorizes when treated for a few seconds with 20 per cent nitric or 25 per cent sulphuric acid, *Bacillus lepræ* is decidedly unwarranted. Excluding these so-called acid-resisting organisms, the reported cultivations of *Bacillus lepræ* are reduced to 6. Of these organisms, 4 are of the diphtheroid type and 2 are rods.

How may these discrepancies be explained? We know that in cultures of the tubercle bacillus a filamentous form of growth has frequently been observed. This has also been noted in sputum of tuberculous persons, where hyphælike filaments are branched and often have swollen ends. In accordance with these findings, some bacteriologists class the tubercle bacillus with the trichomycetes or with the true molds of which the

streptothrix is a type, while others place the tubercle bacillus and closely allied organisms in a special group holding an intermediate position between the streptotricheæ and the ordinary bacilli. I believe, with Jordan,⁽³⁾ that the tubercle bacillus and its near allies will eventually prove to be parasitic forms of the higher molds. Foulerton,⁽⁴⁾ in 1910, in his Milroy lectures before the Royal College of Physicians, London, mentions

the apparent affinity between certain undoubted species of *Streptothrix* and the parasite, or parasites, of tuberculosis. A comparison of the biological characteristics of the recognized streptothrix organisms on the one hand and of different "strains" of the parasite of tuberculosis on the other leaves no doubt as to the correctness of the opinion held by certain earlier pathologists who maintained, within a few years of Koch's announcement of his discovery of the cause of tuberculosis, that the reputed bacillus was not, in fact, a fission fungus at all, but rather belonged to a higher group of mold fungi.

There is, undoubtedly, a very close relation between leprosy and tuberculosis, and if we accept Foulerton's conclusions as correct in regard to tuberculosis why may not similar ones be true of the organism known as Hansen's bacillus?

From the spleens of two lepers who died at San Lazaro Hospital I have succeeded in cultivating an absolutely nonacid-fast streptothrix. These two strains are apparently identical, and now grow readily on the ordinary glycerin agar, but the original isolations were slow in growth. They were made on placental agar and fish-juice agar, and required from three to four weeks for growth to become apparent. The growth of this organism may be described as spreading, with a tendency toward the formation of small islets with an elevated center. These eventually coalesce, and the surface growth is dull and more or less rugose. It is pearly white in young cultures, becoming brown in cultures more than four months old. There is a tendency to spore formation in old cultures, as evidenced by the formation of white patches which appear at the uppermost part of the stroke and gradually extend downward to the butt of the tube. The growth is very adherent to the medium, and cannot be removed without bringing medium along with it.

In bouillon with or without glycerin there is a very scanty growth, and this has a tendency to creep up the sides of the tube and also to collect at the bottom as a powdery sediment. Stained preparations at this stage show long and short threads with a well-marked tendency to branch as shown in Plate I, *a*. In older cultures, three to four months old, there is tendency for the filaments to break up into coccoid and rodlike forms as seen

in Plate I, *b*. These are, at first, nonacid fast; after six to seven months a few will be noted as retaining the fuchsin slightly, others will not stain at all either with the original stain or the counterstain, and after a year there will be found scattered clumps of distinctly acid-fast bacilli occurring as isolated individuals and rods still inclosed in the parent hypha (Plate I, *c*).

In the latter part of February, 1913, several 48-hour cultures of this streptothrix were rubbed up in a mortar and a number of guinea pigs and rabbits were inoculated with this suspension. The rabbits were all inoculated with 1 cubic centimeter intravenously; the guinea pigs, with 0.5 cubic centimeter subcutaneously in each groin. Of this series, 1 animal died while 3 animals are still alive; the others, numbering 16, were killed at varying periods from a week up to six months. No lesions were discovered post mortem in the series of animals killed. The guinea pig dying in September, however, showed a slightly enlarged liver with a few scattered nodules on the under-surface. There was no glandular enlargement. Smears from the cut surface of several of the nodules showed no organisms, but many small rounded masses from 3 to 6 microns in greatest diameter were visible; these were distinctly acid fast. I have noted similar masses in the juice expressed from a leproma, in scrapings from a nasal ulcer in a leper, and also in old cultures of the streptothrix. Some of these bodies had frayed-out edges, and resembled blood plates as we sometimes see them.

Nine days after, cultures made from these nodules showed in two tubes of placental agar a slight whitish growth of about the consistency of cream cheese. It was spreading, did not grow in the water of condensation, and at the end of four weeks covered the surface of the slant. Stained preparations from these cultures showed long and short rods which were distinctly acid fast. Growth in bouillon was slow, and mostly at the bottom; there was occasional pelicle formation. Marked clubbing occurred, as seen in Plate I, *d*, *e*, and *f*. In bouillon the bacillary forms show a tendency to lose the acid-fast property; this is regained, however, on transfer to either placental agar or Dorset egg plus 1 per cent glycerin. All of the clubbed forms are distinctly acid fast.

In April a second series of animals was inoculated as before. One of the guinea pigs developed a pussy discharge from its left eye eight days after inoculation. Stained smears showed enormous quantities of acid-fast bacilli. Cultures from this

guinea pig were all negative at the end of two months. This animal died some nine months later, and the liver, lungs, spleen, and some of the lymphatic glands showed marked nodular involvement. Smears from the different organs showed a few acid-fast bacilli. Sections were examined by Dr. B. C. Crowell of the Bureau of Science, who reported that the lesions would, ordinarily, be described as tubercular. Cultures made from the spleen on placental agar showed after two weeks a growth practically identical with the first isolation. Efforts to identify the organisms isolated by means of agglutination and deviation of complement tests have been so far unsatisfactory.

So far as I know, but two other investigators have injected a streptothrix and recovered an acid-fast rod; these were Bayon of London and Kedrowski of Moscow. Bayon also recovered a streptothrix after inoculating a rat with this acid-fast rod. At the present time I have a series of animals under observation to test whether or not the acid-fast rod becomes a streptothrix in the animal body. I have noted, however, a decided tendency for the cultures of the acid-fast rod form to throw back, as it were, and show decided streptothrix forms. In conclusion I can only say that at this stage of my work I am quite convinced that *Bacillus lepræ* is but the acid-fast stage of a markedly pleomorphic streptothrix.

BIBLIOGRAPHY

1. HANSEN, A. *Norsk. Mag. f. Laegevidensk* (1872), 2, 1.
2. WOLBACH, S. B., and HONEIJ, JAMES A. *Journ. Med. Research* (1914), 29, 367.
3. JORDAN, E. O. A textbook of General Bacteriology. W. B. Saunders Company, Philadelphia and London. 3d ed. (1913), 347.
4. FOULERTON, A. G. R. *Lancet* (1910), 1, 551, 626, 769.

ILLUSTRATION

PLATE I. (*a*) Hyphæ, showing branching—commencement of breaking-down stage; (*b*) coccoid and bacillary forms; (*c*) clump of acid-fast bacilli; (*d, e, f*) clubbed forms.

126334—3

231

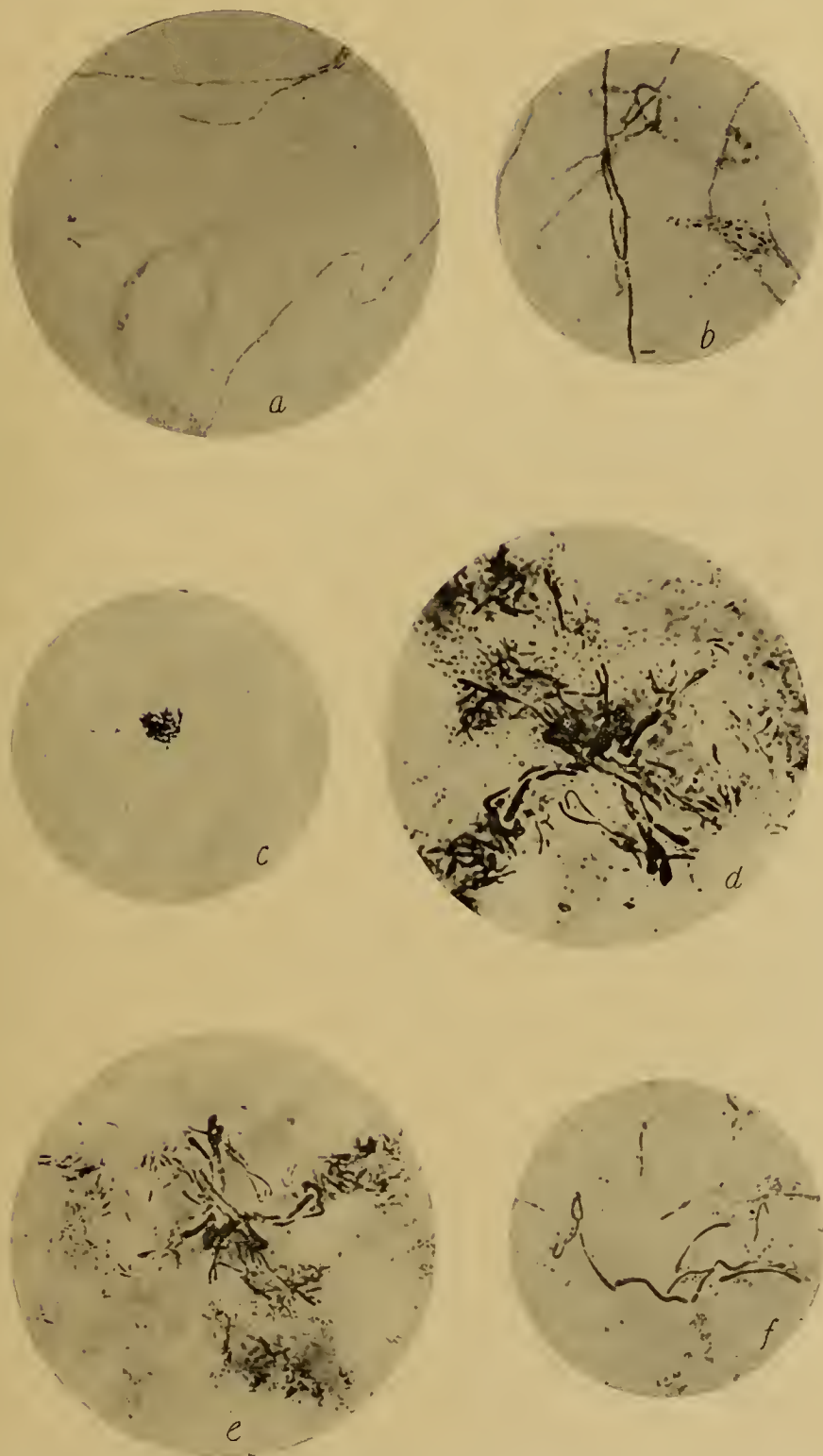

PLATE I. (a) HYPHÆ, SHOWING BRANCHING—COMMENCEMENT OF BREAKING-DOWN STAGE; (b) COCCOID AND BACILLARY FORMS; (c) CLUMP OF ACID-FAST BACILLI; (d, e, f) CLUBBED FORMS.

INTESTINAL HELMINTHIASIS IN THE PHILIPPINE ISLANDS AS
INDICATED BY EXAMINATIONS OF PRISONERS UPON
ADMISSION TO BILIBID PRISON, MANILA, P. I.

By DAVID G. WILLETS

(From the Biological Laboratory, Bureau of Science, Manila, P. I.)

The results obtained in examinations of inhabitants of the Philippine Islands for evidences of intestinal parasitism have shown that the percentage of persons infected with any one species of organism has varied considerably. For instance, infections with *Trichuris* and with hookworms have ranged from 6 to 88 and 8 to 54 per cent, respectively. The investigations yielding these results have been made in distinctly circumscribed localities and chiefly among laborers. An accurate idea of the average prevalence of intestinal helminthiasis in the Archipelago could be obtained only by examining persons from all parts of the Islands, of all ages, of both sexes, of all occupations, of all social classes, and of all races. Opportunity for the examination of individuals from all parts of the Islands is offered more or less completely at Bilibid Prison. The inmates are, however, mostly of the lower classes of society and children are rarely admitted. The examinations here reported were made upon 7,843 adult males upon admission to the prison. All cases which had been in the institution previously were excluded from the series for the reason that some of their infections may have been contracted in the prison. The Filipinos of the series number 6,416; the Chinese, 1,427. About 300 females were examined, but this number is too small to permit their inclusion in the report. It was intended originally to extend this investigation over several years, in order that a large series of cases might be secured. The work has been interrupted permanently, however, and therefore a report is made of the results at hand with the realization that they must be interpreted with caution. Three phases of helminthiasis among adult male Filipinos and Chinese in the Philippine Islands are considered. First, the average prevalence of helminthiasis in Filipinos; secondly, its geographic distribution among Filipinos; and, thirdly, its relative frequency among Chinese and Filipinos.

The conditions limiting the work were as follows:

1. One cover-slip preparation was examined of the one specimen obtained from each case.

2. The majority of the examinations were made by Filipino "trusties" under the supervision of various members of the biological laboratory, Bureau of Science (Drs. P. E. Garrison, Y. K. Ohno, F. B. Brown, Liborio Gomez, and D. G. Willets). The findings are, therefore, not as exact as they would have been if the examinations had been made by more experienced individuals.

3. Examinations were made within seventy-two hours of admission. Since travel from sections of the Islands which are most remote from Manila practically never requires more than three weeks and since about one month after the date of infection with the several species of parasites concerned is necessary for evidences of them to appear in the fæces, it may be considered that the positive results obtained indicate infections which the individuals examined possessed when they started for the prison. Protozoan findings were excluded because they may have been contracted en route.

4. None of the individuals examined had been an inmate of the prison previously. All of them were adult males.

The results obtained are given in Tables I, II, III, and IV. They may be compared with those of similar investigations in the Philippines by consulting tables prepared by me.¹ In making comparison, it should be noted that the majority of the series of cases studied are composed of males and females, as well as adults and children of given communities.

Garrison² examined Bilibid prisoners, and a summary of his helminthic findings is given in Table V. The percentage of persons harboring *Trichuris*, *Ascaris*, and hookworms differs greatly in his series of cases and mine.

The cause of these variations cannot be due to any great extent to the personal equation entering into the examinations, because the ova of *Trichuris*, *Ascaris*, and hookworms are easily recognized by one seeing them daily,³ nor can it be due to any change outside of the prison, for a greater percentage of the admission cases of 1910 were infected than those of 1908. It is probable, therefore, that the variations are due to conditions within the prison at the time Garrison made his examinations

¹ *This Journal*, Sec. B (1911), 6, 77.

² *Ibid.* (1908), 3, 1911.

³ For instance, the "trusties" already mentioned.

or prior thereto and that these conditions were favorable to the propagation of hookworms and *Trichuris* and unfavorable to that of *Ascaris*. The differences in the *Trichuris* and *Ascaris* percentages, however, may be explained in part by the fact that *Ascaris* infections are treated at the prison hospital as a routine procedure, whereas *Trichuris* infections are not treated unless they are heavy. Such a state of affairs would naturally lead to carelessness in observing light *Trichuris* infections in making examinations to detect cases for treatment, such as those here recorded. Garrison examined some admission cases but chiefly those which were already in the institution, and his findings represent an endemic condition.⁴ Improved sanitary conditions in the institution have been efficacious in markedly lowering the incidence of intestinal helminthiasis as shown by the results obtained in the examinations of 930 prisoners in 1910 (Table VI). As indicated in the table, these individuals had been prisoners for periods varying from a few months to four years. The only species of helminthic parasites which gave an increased percentage upon length of residence was the seat-worm (*Oxyuris*).

A map showing the distribution of infections with the several species of parasites found in the examinations of the Filipinos of the series was prepared. It showed that the distribution of the various parasites is extremely irregular. Adjacent northern and adjacent southern provinces gave in some instances very different results. Former investigations predicted this result. Indeed, it is on record that Garrison, Leynes, and Llamas⁵ and Rissler and Gomez⁶ found quite different percentages of infection with *Trichuris* in Rizal Province.

The low percentage of Chinese infected in general and with each common species of parasite, as shown in Tables II and III, is remarkable. The explanation of the differences in infec-

⁴ It is well known that the sanitary conditions at the prison were deplorable prior to their being placed in the hands of the Bureau of Health, shortly before Garrison's investigation was begun. It is further known that these conditions were changed, so that within a period of a few months sound sanitary regulations were in force. Since that time, routine examination of stools for evidences of intestinal parasitism has been regularly made by the Bureau of Science, and infected cases have been treated. Prisoners, new ones or those who have been detailed for outside work, are held in quarantine for five days upon admission. If an individual is found to harbor intestinal parasites other than *Trichuris* or monads, he is treated in the prison hospital until apparently cured.

⁵ *Ibid.* (1909), 4, 257.

⁶ *Ibid.* (1910), 5, 267.

tion percentage among the Chinese and Filipinos must be that the former are exposed less than the latter to the sources of infection with intestinal helminthic parasites. It is to be noted in this connection (1) that Chinese use chopsticks when eating, whereas lower class Filipinos use their fingers; (2) that Chinese drink a great deal of tea (boiled water), whereas Filipinos do not; (3) that Chinese eat less uncooked food than Filipinos; (4) that many of the Chinese were shopkeepers or clerks, whereas most of the Filipinos were laborers, and consequently the former were less liable to soil infection than the latter.

TABLE I.—Summary.

Examinations and infections.	Number.	Per cent.
Persons examined.....	7,843	
Persons infected.....	5,421	69.1
Persons infected with—		
<i>Trichuris</i>	3,690	47.1
<i>Ascaris</i>	3,211	40.9
Hookworm.....	1,737	22.2
<i>Strongyloides</i>	65	0.8
<i>Oxyuris</i>	57	0.7
<i>Tænia</i>	57	0.7
<i>Clonorchis</i>	8	0.1
<i>Hymenolepis nana</i>	4	0.05
<i>Schistosoma japonicum</i>	3	0.05
Total.....	8,832	112.60

TABLE II.—Race distribution.

Examinations and infections.	Race.				Total.	
	Filipinos.		Chinese.			
	Number.	Per cent.	Number.	Per cent.	Number.	Per cent.
Examined.....	6,416		1,427		7,843	
Positive.....	4,940	77.0	481	33.7	5,421	69.1
<i>Trichuris</i>	3,447	53.7	243	17.0	3,690	47.1
<i>Ascaris</i>	2,946	45.9	265	18.6	3,211	40.9
Hookworm.....	1,643	24.0	94	6.6	1,737	22.5
<i>Strongyloides</i>	60	0.9	5	0.4	65	0.8
<i>Oxyuris</i>	55	0.9	2	0.1	57	0.7
<i>Tænia</i>	53	0.8	4	0.3	57	0.7
Miscellaneous.....	10	0.2	5	0.4	15	0.2
Total infections.....	8,214	123.0	618	43.3	8,832	112.6

TABLE III.—*Distribution, Manila versus provinces.*

Examinations and infections.	Manila.				Provinces.				Total.	
	Filipinos.		Chinese.		Filipinos.		Chinese.			
	Num-ber.	Per-cent.	Num-ber.	Per-cent.	Num-ber.	Per-cent.	Num-ber.	Per-cent.	Num-ber.	Per-cent.
Examined	3,253		1,176		3,163		251		7,843	
Positive	2,571	79.0	360	30.6	2,369	74.6	121	48.2	5,421	69.1
<i>Trichuris</i>	1,973	60.7	187	15.9	1,474	46.6	56	22.3	3,690	47.1
<i>Ascaris</i>	1,591	48.9	188	16.0	1,355	42.8	77	30.7	3,211	40.9
Hookworm	619	19.0	72	6.1	1,024	32.4	22	8.8	1,737	22.2
<i>Strongyloides</i>	29	0.9	4	0.3	31	1.0	1	0.4	65	0.8
<i>Oxyuris</i>	24	0.7	2	0.2	31	1.0			57	0.7
<i>Tænia</i>	13	0.4	2	0.2	40	1.3	2	0.8	67	0.7
Miscellaneous	5	0.2	5	0.4	5	0.2			15	0.2
Total infections ..	4,254	130.8	460	39.1	3,960	125.2	158	62.9	8,832	112.6

TABLE IV.—Geographical distribution of infections in Filipinos.

Locality.	Examined.	Positive.		Trichuris.		Ascaris.		Hookworm.		Strongyloides.		Oxyuris.		Taenia.		Miscellaneous.		Total infections.	
		Num-ber.	Per-cent.	Num-ber.	Per-cent.	Num-ber.	Per-cent.	Num-ber.	Per-cent.	Num-ber.	Per-cent.	Num-ber.	Per-cent.	Num-ber.	Per-cent.	Num-ber.	Per-cent.	Num-ber.	Per-cent.
PROVINGCES.																			
Albay	74	56	75.7	32	43.2	44	59.5	25	33.8	1	1.4	1	1.4					103	139.2
Ambos Camarines	79	58	73.4	28	35.3	25	31.6	40	50.6									98	117.7
Antique	27	22	81.5	16	59.3	15	55.6	9	33.3	1	3.7	2	7.4	1	3.7			44	163.0
Bataan	26	22	84.6	10	38.5	13	50.0	10	38.5									33	126.9
Batangas	138	87	63.0	38	27.6	47	34.1	39	28.3	1	0.7	1	0.7					126	90.6
Bohol	21	19	90.5	13	61.9	14	66.7	7	33.3									34	161.9
Bulacan	106	79	74.5	55	51.9	56	52.8	22	20.8	1	0.9	2	1.9					136	128.3
Cagayan	71	57	80.3	30	42.2	36	50.7	18	25.4							a1	1.4	85	119.7
Capiz	138	108	78.3	84	60.9	51	37.0	43	31.2	4	2.9							182	131.9
Cavite	91	69	75.8	52	57.1	46	50.5	11	12.1			1	1.1					110	120.9
Cebu	224	185	82.6	114	50.9	105	46.9	90	40.2	2	0.9	5	2.2					316	141.1
Ilocos Norte	84	38	45.2	14	16.7	14	16.7	15	17.9			2	2.4	1	1.2			46	54.8
Ilocos Sur	91	66	72.5	34	37.4	33	36.3	27	29.7			2	2.2	4	4.4	b1	1.1	99	108.8
Iloilo	189	158	83.6	127	67.2	87	46.0	77	40.7	4	2.1			1	0.5			296	156.6
Isabela	25	17	68.0	8	32.0	11	44.0	6	24.0			1	4.0					26	104.0
Laguna	110	67	60.9	36	32.7	26	23.6	34	30.9			1	0.9					97	88.2
La Union	80	57	71.3	22	27.5	41	51.3	23	28.8	1	1.3	1	1.3	5	6.8	c1	1.3	94	117.5
Leyte	159	122	76.7	85	53.5	56	35.2	65	40.9	2	1.3	1	0.6			c1	0.6	210	132.1
Mindoro	19	13	68.4	9	47.4	8	42.1	6	31.6									23	121.1
Misamis	55	45	81.8	35	63.6	23	41.8	14	25.5									72	130.9
Mountain	38	26	68.4	13	34.2	16	42.1	9	23.7	1	2.6	2	5.3	6	15.8			47	123.7
Nueva Ecija	97	63	64.9	26	26.8	33	34.0	32	33.0					1	1.0			92	94.8
Nueva Vizcaya	29	15	51.7	2	6.9	9	31.0	5	17.2					4	13.8			20	69.0
Occidental Negros	140	127	90.7	89	63.4	68	48.6	62	44.3	1	0.7	1	0.7					221	157.9
Pampanga	100	80	80.0	49	49.0	59	59.0	29	29.0			3	3.0					140	140.0

Pangasinan.....	315	219	69.5	124	39.4	119	37.8	100	31.7	4	1.3	4	1.3	9	2.8	360	114.3
Rizal.....	234	197	84.2	160	68.4	129	55.1	69	29.9	4	1.7	4	0.9	2	0.9	366	156.4
Samar.....	78	63	80.8	43	55.1	35	44.9	34	43.6	1	1.9	1	1.9	1	1.9	112	143.6
Sorsogon.....	54	46	85.2	30	55.6	34	63.0	16	29.6	1	1.9	1	1.9	1	1.9	81	148.1
Surigao.....	22	18	81.8	14	63.6	12	54.5	6	27.3	1	4.5	1	4.5	1	4.5	33	150.0
Tarlac.....	136	100	73.5	43	31.6	53	39.0	49	36.0	2	1.5	2	1.5	5	3.7	153	112.5
Tayabas.....	97	54	55.7	27	27.8	24	24.7	28	28.9	1	1.0	1	1.0	1	1.0	80	82.5
Zambales.....	16	16	100.0	12	75.0	13	81.3	4	25	1	1.0	1	1.0	1	6.3	30	187.5
MANILA DISTRICTS.																	
Unspecified.....	209	148	70.8	114	54.5	81	38.8	31	14.8	2	1.1	2	1.1	1	0.6	226	108.1
Miscellaneous.....	178	126	70.8	95	53.4	73	41.0	35	19.7	2	1.1	2	1.1	1	0.6	209	117.4
Binondo.....	427	331	77.8	244	57.1	208	48.7	83	19.4	7	1.7	7	0.5	2	0.5	544	127.4
Ermita.....	51	42	82.4	30	58.8	20	39.2	13	25.4	2	1.3	2	1.3	1	0.7	63	123.5
Intramuros.....	152	118	77.5	84	55.3	67	44.1	36	23.7	2	1.3	2	1.3	1	0.8	190	125.0
Malate.....	131	101	77.1	73	55.7	62	47.3	22	16.8	3	2.3	3	0.8	1	0.8	162	123.7
Paco.....	178	146	82.0	117	65.7	79	44.4	43	24.2	1	0.6	1	0.6	2	1.1	242	135.9
Quiapo.....	113	87	77.0	67	59.3	41	36.3	28	24.8	1	0.9	1	0.9	1	0.9	137	121.2
Sampaloc.....	283	214	75.6	169	59.7	126	44.5	66	23.3	4	1.4	4	0.4	3	1.1	371	131.1
Santa Cruz.....	429	330	76.9	256	59.7	196	45.7	71	16.6	5	1.2	5	0.5	2	0.5	531	123.8
Tondo.....	972	827	85.1	646	66.5	574	59.1	170	17.5	5	0.5	5	1.1	4	0.4	1,411	145.2
Trozo.....	130	101	77.7	78	60.0	64	49.2	21	16.2	1	0.8	2	1.5	2	1.5	168	129.2
Total.....	6,416	4,940	77.0	3,447	53.7	2,946	45.9	1,643	24.0	60	0.9	55	0.9	53	0.8	8,214	128.0

^a *Hymenolepis*.

^b *Clonorchis*.

^c *Schistosoma*.

TABLE V.—Summary of Garrison's helminthic findings.

Examinations and infections.	Number.	Per cent.
Examined	4,106	
<i>Trichuris</i>	2,426	59.0
Hookworm	2,135	52.0
<i>Ascaris</i>	1,052	26.0
<i>Strongyloides</i>	132	3.0
<i>Oxyuris</i>	32	0.8
<i>Tænia</i>	30	0.7
<i>Paragonimus</i>	18	0.4
<i>Schistosoma</i>	16	0.4
<i>Opisthorchis</i> [<i>Clonorchis</i>]	11	0.3
<i>Hymenolepis</i>	5	0.1

TABLE VI.—Reëxamination of 930 ^a prisoners for intestinal helminthiasis.

Examinations and infections.	Number.	Per cent.
Examined	930	
<i>Trichuris</i>	248	26.7
<i>Ascaris</i>	60	6.5
Hookworm	53	5.9
<i>Oxyuris</i>	41	4.4
<i>Strongyloides</i>	8	0.9
<i>Tænia</i>	1	0.1

^a Length of residence in the prison was as follows: Less than one year, 241; from one to two years, 150; from two to three years, 336.

BACILLARY DYSENTERY: THE MOST PREVALENT FORM IN MANILA AND ITS TREATMENT

By W. E. MUSGRAVE and A. G. SISON

*(From the Department of Medicine, University of the Philippines, and the
Philippine General Hospital)*

The word "dysentery" should not be used in medicine except to represent the "clinical complex" of bloody stools, tenesmus, etc., for which it was originally employed. In this sense, it represents many diseases both pathologically and etiologically. In fact, any type of colitis, whether primary or secondary, may be expressed clinically as "dysentery." On the other hand, definite pathologic lesions of the colon of specific etiology at one time may be associated with "dysentery," and at other times may exist without material disturbance of the bowel evacuations, and in still other instances may be associated with constipation. Such conditions are so well known that they need not be discussed.

Scientific nomenclature, at least, should recognize diagnoses based upon etiology as far as possible. When the etiology is unknown, naming the pathologic condition as a diagnosis is acceptable, and only when both etiology and pathology are not known is it justifiable to use a "clinical syndrome" as a diagnosis.

This is particularly true of diseases associated with disturbances in the evacuation of the bowel contents, whether as "dysentery," "diarrhœa," or "constipation."

In no other classes of disease are "slipshod" methods of diagnosis, which are based upon the obvious clinical symptoms, fraught with more danger to the patient; and there are no diseases where there is less excuse for perpetuating the practice.

The "bacterial dysenteries"—the subject assigned for this discussion—include a large and important group of the colites of the large intestine.

The bacteria concerned are of many species. Some of them are rather definite and positive in action, others are influenced in their pathogenicity to a material extent by conditions of environment and resistance on the part of the host, and still others produce definite lesions only under unusual conditions. The unusual conditions may consist in intrinsic variations in the toxicity of the bacteria, modifications in the resistance of the host, or differences in environmental conditions within the intestine or elsewhere.

For example, as is well known, staphylococci, streptococci, the colon bacilli, and other organisms frequently, if not usually, are found in the normal intestine, and it is a fact that under certain conditions these organisms may be the responsible agents in an acute colitis. *Bacillus dysenteriae* under ordinary circumstances is found associated with, and is accepted as the cause of, one type of acute colitis. Under certain conditions of immunity on the part of the host, decreased virulence of the strain of the organism may occur, and under other circumstances which probably are not explainable with our present knowledge this bacillus may persist for long periods of time in a perfectly healthy intestine—the bacillus “carrier.” However, let this protected balance be broken in any of its links as by (a) decreased immunity on the part of the host, (b) increased virulence or volume of infecting agents, or (c) altered environmental influence, and a severe colitis results.

All of these influences are important considerations in the spread of the infection, and in communities where public health and personal hygiene are not the most efficient it is largely by establishing balanced combinations of these conditions that epidemics are controlled.

HISTORICAL

Shiga¹ described a bacillus occurring in an epidemic of dysentery in Japan, and concluded that this organism was the cause of the disease. Flexner² described a very similar bacillus occurring in an epidemic of dysentery among American soldiers in the Philippine Islands. Strong and Musgrave³ isolated a very similar organism from cases of acute dysentery in Manila, and proved its etiologic relationship to the disease by experiments on animals and in one case on man.

Kruse⁴ described a dysentery bacillus similar to Shiga's as being the positive agent in an epidemic of dysentery in Germany.

Careful laboratory workers very soon began to notice slight cultural differences between the various strains of the organisms isolated by the different workers, and various classifications of the group have been made as a result of studies from the different laboratories.

¹ *Centralbl. f. Bakt.* (1898), 23, 599.

² *Bull. Johns Hopkins Hosp.* (1900), 11, 231, and *Centralbl. f. Bakt.* (1900), 28, 626.

³ *Rep. Surgeon-General U. S. Army* (1900), 251.

⁴ *Deutsch. med. Wochenschr.* (1900), 26, 637.

Among the important contributions in regard to this are those of Hiss and Russel,⁵ Martini and Lentz,⁶ Shiga,⁷ and many others.

During the past decade it has been shown conclusively that the dysentery group of organisms is world wide in its distribution, that it is the principal cause of epidemic dysentery, "jail" dysentery, "camp" dysentery, etc., and that various members of the group are important causative factors in infantile diarrhoea and "ileocolitis."

The types of organisms and the clinical varieties of the infections are of importance to all students of tropical medicine, and considerable work has been done on the subject in various warm countries.

THE PHILIPPINE ISLANDS

The influence of these organisms is of special interest to practitioners of medicine and students of pathology in this country.

Acute colitis was one of the most serious problems which confronted the United States Army during its early days in this country.

The first published work on the subject from the Philippine Islands was an article by Flexner and Barker.⁸

The authors who represented the Johns Hopkins University as a commission had ample material in the epidemic of acute dysentery among American soldiers in Manila. They isolated and described an organism very closely allied to the one previously discovered by Shiga in Japan. They considered the bacillus to be the cause of acute dysentery seen in Manila at that time.

Strong and Musgrave⁹ studied over 1,300 cases (with 271 autopsies) of dysentery, principally among American soldiers, and recognized two varieties of the disease: (1) Acute specific bacillary dysentery and (2) amœbic dysentery. From the acute bacillary form of the disease, they isolated an organism which was identical with that of Flexner and Barker and which was shown to be very similar to, if not identical with, the original

⁵ *Med. News* (1903), 82-89.

⁶ *Zeitschr. f. Hyg.* (1902), 41, 540.

⁷ *This Journal* (1906), 1, 485.

⁸ *Phila. Med. Journ.* (1906), 6, 414; also, *Bull. Johns Hopkins Hosp.* (1900), 15, 231.

⁹ *Annual Rep. Surgeon-General U. S. Army for 1900*; also *Journ. Am. Med. Assoc.* (1900), 35, 498.

organism described by Shiga. The authors proved the etiologic importance of this organism by experiments on animals and in one case on man, and they were the first to isolate the bacillus from the lymphatic glands.

Shiga¹⁰ reported extensive comparative studies between various strains of the organisms, including the ones from Manila. He credited the proof of the etiologic status of the organism to Strong and Musgrave.

Ohno¹¹ published an extensive study of all the available strains of dysentery bacilli. He elaborated the classification into five varieties.

Bowman¹² studied an epidemic of infantile dysentery in Manila during August, 1907, from private patients selected from our service.

An organism of the typhoid-colon group with certain definite distinctions was isolated from all these cases. This organism, which Bowman designated as *Bacillus* "S," appeared to be the causative agent in this epidemic.

In cultural characters, *Bacillus* "S" is smaller and more delicate than *B. coli* or *B. dysenterix*, and it is actively motile. Toxic properties and comparative agglutination tests seem to show that it is distinct from other organisms of the group. However, it is rather closely allied to Morgan No. 1, which was found by Phalen and Ashburn in one epidemic of acute dysentery in and around Manila.

The prevalence and influence of the "Y" bacillus of Hiss and Russel¹³ in infantile dysentery and further studied by Hiss¹⁴ have been studied in the Philippine Islands by Whitmore. These organisms are being assigned an important etiologic rôle in colitis of children in Europe,¹⁵ and should be studied particularly with reference to the benign dysenteries among children in this country.

Phalen and Kilbourne¹⁶ described an epidemic of bacillary dysentery in Luzon.

Bacteriologic studies of 8 cases at Camp McGrath showed Morgan's No. 1 bacillus¹⁷ in 5 cases, but no dysentery organ-

¹⁰ *This Journal* (1906), 1, 485.

¹¹ *Ibid.* (1906), 1, 951.

¹² *Ibid.*, *Sec. B* (1908), 3, 31.

¹³ *N. Y. Med. News* (1903), 82, 289.

¹⁴ *Journ. Med. Research* (1904), n. s. 8, 12.

¹⁵ *Arch. f. Kinderheilk.* (1913), 60-61, 35, 689.

¹⁶ *Milit. Surgeon* (1910), 26, 433.

¹⁷ *Brit. Med. Journ.* (1906), 1, 908; (1907), 2, 16.

ism was obtained in the other 3 cases. Two dysentery cases out of 4 from Camp Eldridge, Laguna, yielded Morgan's No. 1 bacillus. Of 2 cases examined at Fort William McKinley, Morgan's No. 1 bacillus was isolated from one; the other case was subsequently diagnosed as amœbic.

Of 3 cases studied in Manila, one was negative, the Shiga type of *B. dysenterix* was isolated from one, and the Flexner type from the third.

These authors recognize two main groups of dysentery-producing bacilli, the Shiga type including Kruse's organism and the Flexner type which includes those of Strong and Musgrave and of Gray and Duval. Other organisms which had been considered as probable causative agents at that time were Bowman's *Bacillus* "S."

They conclude that:

Bacillary dysentery is endemic in the Philippine Islands at all times, occasionally assuming epidemic proportions over more or less wide areas. The disease is due to at least three types of dysentery organisms, the well-known Shiga and Flexner types and the less known organism of Morgan. In the region south of Laguna de Bay the Morgan type alone was encountered, and this organism appears to be the predominating cause of the recent epidemic. In and about Manila, where the cases were more scattered and scarcely assumed epidemic proportions, organisms of the Shiga and Flexner types were found. * * *

It does not appear that the disease caused by one type of dysentery bacillus differs from that caused by another in its clinical course, its pathology, or its gravity, and the treatment is the same for all. The identification of the bacillus type, then, in any given case, does not seem of importance. The diagnosis of this variety of dysentery must still depend upon the clinical course of the disease and the exclusion of amœba by microscopical examination.

Whitmore¹⁸ studied an epidemic of bacillary dysentery in the Philippine Islands during the summer of 1909. Bacilli, resembling those found in dysentery, were isolated from the stools of a number of the patients affected, and the author made a comparative study of the various strains of the dysentery bacilli. He concluded that they were principally of the Shiga-Kruse type, with a third class less frequently found which includes the "Y" bacillus of Hiss. The Shiga-Kruse type of organism was the only one found in cases studied from the provinces, but the Flexner type was encountered in cases in Manila. The author makes no attempt to associate the type of the bacillus present with the severity or the clinical variety of the disease.

¹⁸*This Journal, Sec. B* (1911), 6, 215.

Chamberlain, Vedder, and Barber,¹⁹ constituting the United States Army board for the study of tropical diseases as they exist in the Philippine Islands, reported an unusually severe epidemic of acute bacillary dysentery raging around the town of Ormoc, Philippine Islands, during the early part of 1912. The disease was most prevalent in children and babies, and the mortality was extremely high. The observers arrived on the scene only toward the end of the epidemic, and were unable definitely to isolate the dysentery bacillus. However, they are of the opinion that the epidemic was due to some variety of the dysentery bacillus. From one case they isolated an organism corresponding in all essential details, except that of mortality, with Bowman's *Bacillus* "S."

Barber and Gomez²⁰ studied an epidemic of acute dysentery at Baguio. There were 23 cases in all; 9 Americans with 2 deaths; 1 Filipino, no death; 11 Igorots with 8 deaths; and 2 of other nationalities with no deaths. They isolated a dysentery bacillus from 14 out of the 23 cases studied. Of the 14 strains of the organism, 10 were of the Shiga type and 4 of the Flexner type. All of the native Igorots of the mountains showed the Shiga type of organism. In all cases where it was possible to trace the source of infection it was found that the disease in Igorots or in foreigners was contracted at one of the railroad camps. Examination of the pail system of this camp showed that there was a large amount of bloody flux among the workmen. Laborers in this camp included all nationalities, and were received from all parts of the Philippine Islands and from Japan.

Ashburn and Vedder²¹ studied an epidemic of acute dysentery prevailing among United States soldiers at Camp John Hay near Baguio. The authors stated that during the year 1911 and part of 1912 there were 81 cases of acute intestinal trouble among the troops in that camp. The clinical symptoms were those usually referred to as "mountain diarrhoea" characterized by diarrhoea with mucus and blood in the stools and by slight fever lasting from two days to a week. From one of these patients the authors isolated a dysentery bacillus of the Flexner type.

During 1912 an epidemic of acute intestinal flux among the troops of one company was studied. The symptoms were mild, consisting of diarrhoea—some blood and mucus—the disease

¹⁹ *Milit. Surgeon* (1912), 30, 318.

²⁰ *Bull. Manila Med. Soc.* (1912), 4, 138.

²¹ *Ibid.* (1912), 4, 139.

lasting for about a week in each case. By agglutination tests, the authors arrived at the conclusion that the epidemic was due to bacilli of the Flexner type.

During the fiscal year 1912-1913, excluding cases of amœbic and other extraneous types, there were treated in our service in the Philippine General Hospital 266 cases of acute colitis.

Distributed according to ages, these cases were as follows:

Age.	Cases.	Age.	Cases.
0 to 5 years.....	67	35 to 40 years.....	20
5 to 10 years.....	15	40 to 45 years.....	4
10 to 15 years.....	8	45 to 50 years.....	4
15 to 20 years.....	35	50 to 55 years.....	2
20 to 25 years.....	45	55 to 60 years.....	1
25 to 30 years.....	37	Total.....	266
30 to 35 years.....	28		

There were 191 males and 75 females.

The total mortality in the 266 cases was 49, or 18.4 per cent. Autopsy was performed on 29 of the cases. The mortality among males was 34, or 17.8 per cent, and among females 15, or 20 per cent.

The mortality according to age is shown in the following table:

Age.	Cases.	Per cent.	Age.	Cases.	Per cent.
0 to 5 years.....	24	9.0	30 to 35 years.....	2	0.7
5 to 10 years.....	5	1.9	35 to 40 years.....	2	0.7
10 to 15 years.....	0	0	40 to 45 years.....	1	0.4
15 to 20 years.....	2	0.7	45 to 50 years.....	3	1.1
20 to 25 years.....	5	1.9	50 to 55 years.....	0	0
25 to 30 years.....	4	1.5	55 to 60 years.....	1	0.4

In considering the mortality statistics in these cases, it must be remembered that they were all hospital cases and consequently represented patients with severe clinical symptoms.

The mortality from this disease in other hospitals is given by various authors as follows:

Japan, 16.5 to 30.2 per cent. Ceylon during 1903, 28.7 per cent. British New Guinea in 1902-3 at 22.8 and 26.6 per cent, respectively. In Singapore where the dysentery is considered mild, the mortality in the hospitals in 1902 was not less than 25.4 per cent, and in the neighboring state of Selangor it reached 34 per cent. In Trinidad it stood at 30.7 per cent, in German

New Guinea at 33 per cent, and in Hongkong in 1902 it reached 37.3 per cent.

ASSOCIATED DISEASES

In 61.6 per cent of the cases, the colitis was associated with other diseases, and the mortality in such double diseases was 57.1 per cent.

The principal associated diseases with their incidence is shown in the following table:

Associated disease.	Cases.	Associated disease.	Cases.
Phthisis.....	18	Oxyuriasis.....	2
Duodenal ulcer.....	1	Amœbiasis.....	10
Ascariasis.....	48	Strongyloidiasis.....	1
Trichuriasis.....	57	Tubercular intestine.....	2
Ankylostomiasis.....	31	Malaria.....	8
Monadiasis.....	11		

COMPLICATIONS

In 30.1 per cent of the cases other conditions believed to be complications of the bacillary infection were encountered, and the mortality in the presence of complications was 59.1 per cent.

The complications noted, with their frequency, are as follows:

Complication.	Cases.	Per cent.	Complication.	Cases.	Per cent.
Mania, acute.....	2	0.7	Rheumatic fever.....	2	0.7
Nephritis, acute.....	37	13.9	Lymphadenitis.....	8	3.0
Bronchopneumonia.....	14	5.2	Œsophagitis.....	1	0.4
Bronchitis.....	9	3.4	Splenitis, acute.....	1	0.4
Acute cardiac dilatation.....	5	1.9	Meningitis.....	5	1.9
Gastroenteritis.....	6	2.3	Hydrothorax.....	2	0.7
Neuritis, multiple.....	2	0.7	Fibrinous pleurisy.....	4	1.5
Abortion.....	6	2.3	Hydrocephalus.....	2	0.7
Prolapsus ani.....	2	0.7	Peritonitis.....	6	2.2
Hæmorrhoids.....	4	1.5	Pneumonia, lobar.....	2	0.7

These complications, while not all due to the influence of *B. dysenterix*, must nevertheless somewhat elaborate our previous conception of the extensive harm which may result from this organism.

For example, Strong and Musgrave, out of a total of 271 autopsies performed in 1899, encountered 111 cases of colitis. Of these, 21 were classified as acute specific bacillary dysentery, 11 as subacute, and 79 as amœbic dysentery. The complications,

associated diseases, and special anatomic findings in the acute bacillary type of the disease are recorded as follows:

Malaria fever	2
Chronic gastric catarrh	2
Bronchopneumonia	3
Acute pleurisy	1
Congestion and œdema of lungs	4
Cloudy liver	8
Cloudy kidneys	5
Fatty liver	1
Fatty kidneys	1
Enlarged spleen	5

More recent writers have included a number of other complications of these infections to such an extent that the dysentery toxin must be classed with that of other severe infections in its action on organs and parts of the body distant from the seat of lesion.

TREATMENT

In spite of our knowledge of the etiology of this disease, we have not as yet a treatment that might be termed specific. This is explained by our knowledge that different types of microorganisms are causative factors of the disease, and this fact together with the different degrees of virulence of the infecting microorganisms in part explains the disparity of opinion regarding the treatment of bacillary dysentery. The treatment recommended as effective by some clinicians has been a failure in the hands of others and vice versa. Many physicians who have had experience in the treatment of bacillary dysentery are in favor of some special drug or of a manner of treatment that has given them the best percentage of cures.

There is one phase of the treatment, however, where all the writers are in accord; that is, the prophylactic treatment. With our knowledge of the etiology of the disease, it is not difficult to observe the measures that will prevent the spread of the disease. Each individual with dysentery must be considered as a focus of infection, and his isolation is necessary. The stools must be properly disposed of, and general hygienic rules must be observed. Overcrowding, uncleanness, over exertion, fatigue, and the use of injudicious diet are some of the predisposing factors that ought to be avoided, especially during dysentery epidemics. All materials that have come in contact with dysenteric patients and the hands of those who attend them should be disinfected. Flies are the main disseminators of the disease, and must be excluded from contact with the patient as well as with food supply.

We have had several infections that have occurred in the Philippine General Hospital during the years of 1911-12 through the agency of flies, as we had a pest of these insects at the time we were taking care of patients suffering from bacillary dysentery. So also the epidemic of dysentery in Baguio during the summer of 1912 was evidently spread by flies, as is proved by the article of Banks read before the Manila Medical Society in the same year, entitled *The Baguio fly campaign*.

CURATIVE TREATMENT

Our routine treatment in the Philippine General Hospital which has given the most satisfactory results consists in the following:

First, absolute rest to save the strength of the patient and to prevent the involvement of the larger segment of the intestine.

Secondly, the early administration of some mild laxative, preferably sodium sulphate or magnesium sulphate, preceded by fractional doses of calomel in order to diminish the presence of infecting material in the gastrointestinal tract, as well as to get rid of some irritating material that might be present there. The administration of *simaruba officinalis* combined with some opiate is highly recommended, for it has given us the most satisfactory result in comparison with the use of other drugs. As an adjuvant to this treatment, the judicious use of normal salt solution as an enema, or given in the form of the drop method per rectum in the amount of 1 liter once a day, is sometimes very beneficial.

When the acute stage of the disease has subsided, enemas of hydrogen peroxide in a weak solution (about 25 cubic centimeters in 500 cubic centimeters of water) once a day are a great help toward prompt recovery.

The use of ipecac, although strongly recommended by some writers, has not given us universal satisfaction. While some patients are benefited by this drug, there are a great many cases in which the use of ipecac becomes another sort of torment to the sufferer. There are many persons who abhor this drug to such an extent that even the smallest amount of it, though combined with opium, is apt to produce in them marked emesis. We have seen cases that are not even able to tolerate Dover's powder given in almost homeopathic doses. This is the greatest drawback to ipecac, and the deëmetinized preparation is almost useless as the active principle of the drug, the emetine, is the one that has some therapeutic action in the treatment of dysentery. The use of astringents and the so-called gastrointestinal antiseptics we have given up as unsatisfactory. Al-

though there is a small percentage of patients who recover under this treatment, we should remember that there are cases that get well even without any medical treatment, and we consider it problematical whether or not the usual astringents and gastrointestinal antiseptics are really beneficial in the treatment of this disease. We must keep in mind the fact that most of the astringents and so-called intestinal antiseptics, such as, bismuth, tannic acid preparations, salol, beta-naphthol, benzo-naphthol, benzoic acid, and others, have an irritating action upon the stomach and intestines especially if they are given in large amounts and over a considerable period of time.

The use of the ice bag over the abdomen is a great help in diminishing the abdominal pain, and hot turpentine stupes frequently are useful for the same purpose.

The essential part of the treatment, however, is dietetic. During the first twenty-four hours of the acute stage of the disease food must be withdrawn. Pieces of cracked ice may be given to allay thirst. At the end of twenty-four hours, we allow the patient albumen water or rice or barley water and later skimmed or peptonized milk. When improvement has begun, milk, broth, beef juice, and orange juice may be given. The mouth must be frequently cleansed with an antiseptic mouth wash to prevent the frequent complications of parotitis and gastritis.

The serum treatment, first recommended by Shiga in 1898, has both advantages and disadvantages. If the variety identification of the bacillus which is the cause of the infection can be carried out with readiness, as well as with accuracy, this scientific treatment ought to yield a greater percentage of cures than usually is obtained. For practical purposes, however, especially in those cases that have to be treated in places where the means of identifying the infecting microorganism are not available, it is a failure in most instances. The sera of patients suffering from one form of bacillary dysentery usually will not agglutinate other varieties of *Bacillus dysenterix*.

It is possible that Flexner's polyvalent serum might be used for any acute bacillary dysentery. However, what we have already mentioned in the discussion of the etiology of dysentery, in regard to the etiologic importance of other microorganisms, such as streptococci, staphylococci, colon bacillus, and others concerned in the production of colitis under certain circumstances, will make the use of even a polyvalent serum unsatisfactory in many instances.

WIDAL REACTIONS AMONG HEALTHY ADULT FILIPINOS

By DAVID G. WILLETS

(From the Biological Laboratory, Bureau of Science, Manila, P. I.)

This work was undertaken for the purpose of determining (1) the percentage of healthy adult Filipinos indicating previous or present infection with *Bacillus typhosus* by the presence of a positive Widal reaction and (2) the percentage of typhoid carriers among this class of individuals. The second phase of the investigation was to have been conducted by Dr. J. A. Johnston of this laboratory, but this work was unfortunately interrupted.¹ The results of the Widal tests alone, however, indicate the advisability of placing them on record. These tests were made on the blood of 300 apparently healthy, young, adult Filipino employees (nurses, etc.) of the Philippine General Hospital. In making the tests, serum only was used. The dilutions and time limits are given in the following table. The microscopic method was used, because it was desired to apply to these cases the same routine test as to suspected typhoid cases. In the midst of the investigation, the typhoid culture was examined morphologically and culturally and found to be quite pure. It may also be stated that from 15 to 30 tests were made at a time and that these were checked against reactions on the blood of known cases of clinical typhoid fever. It will be noted that control reactions were performed in a number of instances. These were made about ten days after the original tests.

After cleaning a portion of a finger or of an ear with 95 per cent alcohol and drying with sterile cotton, a small quantity of blood was collected in a capillary pipette. The smaller end of the pipette was closed in a Bunsen flame, and the larger end with sterile cotton. The specimen was then centrifuged until the supernatant serum was quite free from blood corpuscles, whereupon it was placed in a refrigerator for a period of from a few hours to one day. The serum was drawn off by means of a fine capillary pipette and placed in a watch glass. It was diluted 1 to 20 by use of a pipette for counting leucocytes.

¹In the few cases in which cultures of the fæces and urine were made, *B. typhosus* was isolated in one instance; this case had given a definitely positive Widal reaction.

Equal portions of it and a suspension of typhoid organisms were placed on a cover glass by means of platinum loops of equal size and thoroughly mixed. This constituted the hanging drop used in connection with a depression slide. All glassware was clean but not sterile. In diluting the serum, a separate portion of normal saline solution was used for each specimen. The suspension was prepared from an eighteen to twenty-four hour old acid agar slant subculture with normal saline. The hanging drop was carefully ringed with vaseline. Microscopic observation of the hanging drop was made every few minutes. The 1 to 80 dilution was prepared by taking equal portions of a 1 to 40 dilution of serum and bacterial suspension.

Noteworthy agglutination and loss of motility were present in 49, or 16.1 per cent, of the cases as indicated in Table I. This was of such a degree as to be considered definitely positive in 12, or 4 per cent, of the series of cases. The positive cases are numbers 1, 2, 9, 13, 20, 22, 23, 25, 26, 29, 40, and 49 in the table.

TABLE I.—*Reactions in 49 of the 300 cases examined.*

[Clumping and loss of motility absent (A), complete (C), and partial (P).]

No.	Original reactions.				Check reactions, dilution 1 to 40.	
	Dilution 1 to 40.		Dilution 1 to 80.		Minutes.	Result.
	Minutes.	Result.	Minutes.	Result.		
1.....	40	C				
2.....	30	C				
3.....	55	C				
4.....	60	P	90	P		
5.....	60	P	90	P	90	P
6.....	60	P	90	P		
7.....	60	P	90	P	90	P
8.....	60	P	90	P	60	P
9.....	30	C	60	C		
10.....	60	P	90	A	90	A
11.....	60	P	90	P	90	P
12.....	50	C	90	A	90	P
13.....	20	C	25	C	60	P
14.....	50	C	90	A	90	P
15.....	60	P	90	A	60	P
16.....	60	P	90	A	90	P
17.....	60	P	90	A	90	P
18.....	60	P	90	P	60	P
19.....	60	P	90	P	90	P
20.....	45	C	60	C	60 90	P C
21.....	60	P	90	P	60	P
22.....	35	C	90	C	25	C
23.....	50	C	60	C	45	C

TABLE I.—*Reactions in 49 of the 300 cases examined—Continued.*

No.	Original reactions.				Check reactions, dilution 1 to 40.	
	Dilution 1 to 40.		Dilution 1 to 80.		Minutes.	Result.
	Minutes.	Result.	Minutes.	Result.		
24.....	60	P	90	A	60	A
25.....	45	C	90	C	30	C
26.....	40	C	60	C		
27.....	60	P	90	A	90	P
28.....	60	P	90	P	90	A
29.....	30	C	60	C	30	C
30.....	60	P	90	P	90	P
31.....	60	P	90	P	60	P
32.....	60	P	90	P	60	A
33.....	60	P	90	A	60	P
34.....	60	C	90	C		
35.....	60	C	90	C		
36.....	60	C	90	P		
37.....	60	P	90	A		
38.....	60	C	90	P		
39.....	60	P	90	P		
40.....	45	C	60	C		
41.....	60	P	90	A		
42.....	60	P	90	A		
43.....	60	P	90	A		
44.....	60	P	90	P		
45.....	60	P	90	A		
46.....	60	C	90	C		
47.....	60	C	90	C		
48.....	60	C	90	P		
49.....	30	C	30	C		

In order to determine the probable significance of the complete reactions, the cases diagnosed as typhoid fever in the hospital during the year were investigated. It was found that the clinical diagnosis was verified by positive blood cultures in 8 cases; by anatomical lesions at autopsy in 9 cases; and by both positive blood cultures and anatomical lesions at autopsy in 5 cases. Widal reactions, performed in a manner similar to those upon the healthy adults, excepting that the serum was quite fresh, the dilution 1 to 40 or 1 to 50, and the time limit forty or fifty minutes, were positive in 20, or 90.9 per cent, of these 22 cases as shown in Table II.

TABLE II.—Results of Widal reactions in 22 cases of clinical typhoid fever, verified by positive blood cultures, by anatomical lesions, or by both.

No.	Blood culture.	Ana-tomical lesions.	Widal reaction.	No.	Blood culture.	Ana-tomical lesions.	Widal reaction.
1	+		+	12		+	+
2	+	+	—	13	+		+
3		+	+	14	+	+	+
4		+	+	15	+	+	+
5	+		+	16		+	+
6	+		+	17	+		+
7		+	+	18	+	+	—
8		+	+	19	+		+
9		+	+	20	+	+	+
10		+	+	21		+	+
11	+		+	22	+		+

Only one Widal test was made upon each of the two negative cases (numbers 2 and 18 of the table). In the first one, the test was made on the fifth day of the disease; in the second case, on the eleventh day. Both patients were adults. It is highly probable that a positive reaction would have been obtained in each of these cases if additional tests had been made.

In view of the foregoing facts, it seems reasonable to believe that the complete reactions among the healthy adults indicated an antecedent or a coincident infection with *Bacillus typhosus*.

The significance of the partial reactions is problematical. Since it is known that the agglutinins which make the Widal reaction possible disappear gradually from the blood, some of these reactions may also have indicated an antecedent or a coincident infection with *Bacillus typhosus*. However, the serum used was not inactivated, hence normal agglutinins may have played an important rôle in the production of the partial reactions. Furthermore, the possibility of infections with organisms closely allied to *B. typhosus* must also be considered, for it is commonly known that the agglutinins produced by these bacteria give a positive reaction in low dilutions with *Bacillus typhosus*.

Chamberlain² reported positive Widal reactions (dilution, 1 to 50; time, 1 hour) in 9, or 2.9 per cent, of 307 healthy adult Filipinos. In the same paper statistics are submitted which conclusively prove typhoid fever to be a widely distributed and common disease in the Philippines. The records of the Philippine General Hospital for the period July 1, 1911, to June 30,

² *This Journal*, Sec. B (1911), 6, 299.

1913, indicate that the disease is on the increase. In the fiscal year 1911, 22, or 1.46 per cent, of 1,509; in 1912, 68, or 1.96 per cent, of 3,469; and in 1913, 108, or 3.62 per cent, of 2,985 medical cases were diagnosed as typhoid fever. The annual reports of the Bureau of Health for 1911 and 1913 likewise tend to prove the increased incidence of typhoid or, at least, its increased recognition. In a general way, the increased percentage (4 against 2.9) of positive Widal reactions in our series of healthy individuals as compared with that obtained by Chamberlain in 1910 may be said also to indicate its increased prevalence.

Table III gives the results of Widal reactions performed upon 25 employees of the hospital before and two weeks after antityphoid treatment. If the presence of a positive Widal reaction after treatment is an index of protection against typhoid fever, it appears that the treatment was effective in 21, or 84.0 per cent, of these cases. In this connection it is to be noted that 3 of the 21 cases were positive before treatment.

TABLE III.—*Widal reactions in 25 employees before, and two weeks after, antityphoid treatment. (Serum diluted 1 to 40.)*

No.	Before treatment.		After treatment.		No.	Before treatment.		After treatment.	
	Minutes.	Result.	Minutes.	Result.		Minutes.	Result.	Minutes.	Result.
1.....	60	—	60	—	14.....	60	—	30	+
2 ^a	40	+	60	+	15.....	55	+	30	+
3.....	30	+	30	+	16.....	60	—	30	+
4.....	60	—	60	—	17.....	60	—	60	—
5.....	60	—	30	+	18.....	60	—	30	+
6.....	60	—	30	+	19.....	60	—	45	+
7.....	60	—	60	+	20.....	60	—	45	+
8.....	60	—	60	+	21.....	60	—	45	+
9.....	60	—	30	+	22.....	60	—	40	+
10.....	60	—	35	+	23.....	60	—	50	+
11 ^b	60	—	40	+	24.....	60	—	60	+
12.....	60	—	50	+	25.....	60	—	45	+
13.....	60	—	60	—					

^a Two injections only.

^b One injection only.

EXPERIMENTS ON THE CULTIVATION OF RINDERPEST VIRUS AS DESCRIBED BY BALDREY

By WILLIAM HUTCHINS BOYNTON

(From the Veterinary Division, Bureau of Agriculture, Manila, P. I.)

Baldrey¹ states that he was able to produce material highly toxic for cattle by inoculating broth culture medium with virulent blood and allowing it to incubate at 37° C. for twenty-four hours.

Baldrey conducted his work in accordance with the presumption that rinderpest serum is an antitoxin and that by injecting the toxin obtained by cultural methods, in place of virulent blood, an antitoxic serum could be obtained. In the preliminary work, defibrinated virulent blood was inoculated into ordinary broth in flasks of 500 cubic centimeters' capacity in the proportion of 50 cubic centimeters of blood to 950 cubic centimeters of broth. The medium was incubated at 37° C. for twenty-four hours. Six immunized animals were injected subcutaneously with this, in doses varying from 300 to 700 cubic centimeters. Four of these died in from twenty to twenty-four hours, and the remaining two were destroyed as a result of the extensive gangrene set up at the seat of inoculation. The post-mortem examinations revealed evidence of acute toxæmia.

Three animals formerly used for serum production were employed to test the possibility of hyperimmunizing animals with culture medium and virulent blood after incubation. Martin's broth was employed, but the relative amounts of culture medium and defibrinated virulent blood remained as in the first experiment. The immunizing properties of the sera produced by this method were tested in comparison with other sera.

Baldrey draws the following conclusions from his experiments:

1. That Anti-Rinderpest Serum can be prepared by the inoculation of virulent blood diluted with broth.
2. It appears possible that an active toxin is produced and excreted into the Broth by the Rinderpest organisms contained in the virulent Blood and by this means the results recorded are obtained.
3. This material or probable toxin is rapidly excreted and so active that it appears to quickly inhibit any further growth of the Rinderpest organism, destroying its virulence and finally killing it.

¹ *Journ. Trop. Vet. Sci.* (1911), 6, 251.

4. The substance so obtained is very much more active than that obtained in virulent Blood, so much so that it cannot be given subcutaneously with safety on account of the extreme inflammatory condition it sets up.

5. To use it as an hyper-immunizing agent, doses are better given intravenously and gradually increased so that the "salting" is spread over a period of some 2 months or more.

6. The immune serum so obtained is powerful, but 15-20 per cent. weaker than that made by massive injections of virulent blood.

7. The method is an eminently practical one and shows a great financial saving.

Experiments were performed by me with the view of determining whether or not it is possible to obtain the toxin of rinderpest by cultural methods, as claimed by Baldrey.

Both cattle and carabaos were used. A few were immune to rinderpest, but the majority were susceptible.

Experiment 1.—This experiment was performed to determine the action of Martin's broth alone upon an animal. Since this medium is highly peptonized, it was thought that possibly it might have some effect upon an animal when given in large quantities.

The animal used was Batanes bull 3140, which had previously been immunized to rinderpest and had recovered thirty-eight days prior to this experiment. On October 4, 1911, this animal was injected with 700 cubic centimeters of Martin's broth, neutral in reaction to litmus paper. One hundred cubic centimeters were administered intravenously, and 600 cubic centimeters, subcutaneously.

This animal suffered no apparent ill effects from the injection of the culture medium. It ate heartily, and was thrifty in appearance throughout the experiment. There occurred a slight rise in temperature during the first thirty-six hours following the injection, which may have been due to the peptone content of the broth.

The result obtained in this experiment would lead one to infer that the broth used in the following experiments, by itself, has practically no effect upon the animals.

Experiment 2.—This experiment was designed to duplicate the first experiment described in Baldrey's paper, the only difference being the use of Martin's broth instead of ordinary broth.

The animal used was Batanes bull 3146, which had previously been immunized to rinderpest and had recovered forty days prior to this experiment. On October 7, 1911, this animal received by subcutaneous injection 500 cubic centimeters of Martin's broth, which had been inoculated with 25 cubic centimeters of virulent blood from bull 3217 and kept at 37° C. for twenty-four hours.

This animal showed no ill effects from the injection, and its temperature was normal throughout the experiment.

The results obtained do not coincide with those obtained by Baldrey.

The following experiments were performed with animals which had not previously been immunized to rinderpest. The object was to determine if possible whether the toxin of rinderpest, if present in the inoculated media, would have any effect upon susceptible cattle and also to ascertain if the virus remained alive after being incubated for twenty-four hours at 37° C.

Experiment 3.—The animal used was Batanes bull 3222, susceptible to rinderpest. On October 12, 1911, at 2.30 p. m., this animal received by subcutaneous injection 1,000 cubic centimeters of Martin's broth which had been handled as follows: Nine hundred fifty cubic centimeters of Martin's broth neutral in reaction to litmus paper were inoculated with 50 cubic centimeters of defibrinated virulent blood from carabao 3257 and kept in the incubators at 37° C. for twenty-four hours. There was considerable sediment in the broth at the time it was injected, but no microscopical examination was made to ascertain if it was free from visible microorganisms.

On the evening of October 12, this animal ate very little and appeared uneasy. On the morning of October 13, it presented a slightly accelerated respiration, lay down a greater part of the time, and did not eat. During the afternoon of this day, the animal appeared very sick, and toward evening lay in a sprawled out position. It was observed that several quick respirations would be taken in succession, after which the animal would hold its breath for some time, as if in great pain. It could not get upon its feet, and was not able even to hold its head up for any length of time.

On account of the critical condition, the animal was killed at 5 p. m., which was twenty-six hours and a half after it had received the injection. Post-mortem examination revealed marked œdema at the points of inoculation, hæmorrhagic in places. The duodenum was slightly congested; otherwise the internal organs presented no appreciable change.

The temperature had remained stationary at 38°.8 C. throughout the experiment.

Sections were made from parts of the œdematous tissue. The tissue spaces were filled with rod-shaped organisms, which indicated that the medium evidently had been contaminated with

some organism other than that of rinderpest. This contamination may have had a marked influence upon the symptoms which the animal presented, and it cannot be stated with any certainty that toxin derived from the rinderpest organisms, as stated by Baldrey, was the cause of the condition of the animal at the time it was killed.

Experiment 4.—As soon as bull 3222 was killed, 50 cubic centimeters of the heart blood were injected subcutaneously into bull 3213. This animal suffered no ill effects from the injection, but was afterward proved to be susceptible to rinderpest. This shows that whatever agent caused the condition of 3222, it was not present in sufficient quantity in the heart blood to produce any ill effects upon another animal.

Experiment 5.—The animal used was susceptible Batanes bull 3286. On October 24, 1911, at 9 a. m., this animal received by subcutaneous injection, 700 cubic centimeters of culture broth which had been handled as follows: Nine hundred fifty cubic centimeters of Martin's broth of neutral reaction to litmus paper were inoculated with 50 cubic centimeters of defibrinated virulent blood from bull 3223 and kept in the incubator at 37° C. for twenty-four hours.

On October 27, the animal was noticed to be voiding a large quantity of blood in the urine. On the evening of October 28, it appeared to be very sick, refused food and water, and stood in a hunched up position with staring coat and with the head down. Respiration was rapid and catchy, the animal uttering a low grunt at the beginning of each expiration. There was a marked oedematous swelling along the abdomen and sides of the body. At 11 a. m., the animal lay in a sprawled out position with its head flat on the floor, presented marked symptoms of asphyxia, and frequently struggled. Death occurred at 12.30 p. m.

Post-mortem examination revealed a slight congestion of the duodenum. Other parts of the intestinal tract presented no abnormal appearances. The kidneys were enlarged, markedly congested, contained numerous small hæmorrhages, and were very friable in texture. The capsule was easily removed. The liver was congested and very friable. The subcutaneous tissue was markedly oedematous in the vicinity of the points of inoculation and in the pendent portions of the body.

This animal had a rise in temperature to 40° C. on the third and to 40°.6 C. on the fourth day after receiving the injection.

Sections made from the oedematous tissue revealed numerous

rod-shaped organisms in the tissue spaces similar to those found in the œdematous tissue of bull 3222. Hence, the symptoms and death may have been due to the products formed by these organisms instead of the toxin formed by the rinderpest virus.

Experiment 6.—This experiment was conducted similarly to the former ones with the exception that the broth was faintly alkaline in reaction to litmus paper. The animal used was susceptible Batanes bull 3211. This animal was injected subcutaneously at 2.30 p. m. on October 27, 1911, with 700 cubic centimeters of Martin's broth which had been treated as follows: Nine hundred fifty cubic centimeters of Martin's broth were inoculated with 50 cubic centimeters of defibrinated virulent blood from carabao 3258 and incubated at 37° C. for twenty-four hours.

The animal showed a rise in temperature on the morning of the fifth day after injection, and the temperature remained above 40° C. until the day of death. On the seventh day, the animal developed a diarrhœa, on the eighth day refused food, and death occurred late in the afternoon of the ninth day. Post-mortem examination revealed a marked congestion of the fourth stomach and duodenum. The cœcum was congested and hæmorrhagic in places. The gall bladder was distended and congested, peritonitis was present, and there were erosions in the mouth. From the symptoms and post-mortem findings, one would be justified in concluding that this animal died from a typical attack of rinderpest.

The results obtained from this experiment would lead one to infer that the toxin had not developed to such an extent as to have any vital effect upon the animal and that the virus of rinderpest had not been killed by the incubation nor its virulence depreciated in any respect.

Experiment 7.—This experiment was a duplicate of the preceding one. The virulent blood used to inoculate the medium was taken from carabao 3245.

The animal used in this experiment was susceptible Batanes cow 3294. This animal was injected subcutaneously at 2 p. m., October 31, 1911, with 900 cubic centimeters of the inoculated medium which had been incubated twenty-four hours at 37° C.

No abnormal symptoms were present until the afternoon of the fifth day after injection, when the animal showed a pronounced rise in temperature. The temperature remained abnormally high until the day of death. On the eighth day, the animal developed a diarrhœa and ate but little. On the ninth

day, it presented a profuse diarrhœa and refused food. On the tenth day, bloody mucous casts were passed and the animal lay down most of the time, dying in the evening.

Post-mortem examination revealed erosion ulcers in the mouth; marked ulceration and congestion of the fourth stomach and duodenum; and congestion, ulceration, desquamation, and hæmorrhagic areas in the cæcum, colon, and rectum. Blood-stained mucous casts were present in the lower colon and rectum. Peritonitis and distention of the gall bladder were noted, and the vagina was markedly congested.

The incubation period, symptoms, and post-mortem findings lead to the conclusion that this animal died of a typical attack of rinderpest. Evidently the virus was not destroyed nor its virulence attenuated to any appreciable extent by the medium or incubation for twenty-four hours.

The results obtained from this experiment indicate that the toxin, if produced in the culture medium, was not present in sufficient quantity to have any effect upon either the virus or the animal injected.

Experiment 8.—This experiment was carried on simultaneously with the preceding one, and was similar with the exception that carabao 3262, supposedly susceptible, was used instead of a bull.

The animal was injected subcutaneously at 2.30 p. m., October 31, 1911, with 900 cubic centimeters of Martin's broth, which had been inoculated with 50 cubic centimeters of defibrinated virulent blood from carabao 3245 and incubated for twenty-four hours at 37° C.

The injection of the incubated broth had no immediate effect upon the animal. It did not contract rinderpest, whereas the animal in experiment 7, receiving medium inoculated with blood from the same animal, contracted the disease. This carabao was later injected with 50 cubic centimeters of virulent blood, but did not contract rinderpest. This leads to the conclusion that this animal was immune to the disease at the time of the experiment.

From these results, it will be noted that the culture had no visible effect upon this animal.

Experiment 9.—This experiment varied slightly from the preceding one in that the inoculated medium was incubated forty-eight hours, which gave double the time for the elaboration of toxin.

The animal used in the experiment was susceptible Timor

bull 3293. It was injected subcutaneously at 3 p. m., November 10, 1911, with 900 cubic centimeters of Martin's broth neutral in reaction to litmus. The medium had been inoculated with 50 cubic centimeters of defibrinated virulent blood from carabao 3241, and was incubated forty-eight hours at an average temperature of 36° C.

On the morning of the fourth day after injection, the first rise of temperature occurred, which was followed by a temperature of 40° C. in the afternoon. The temperature remained febrile until the day of death. Diarrhœa developed on the tenth day, at which time the animal displayed inappetence. On the eleventh day, the diarrhœa was profuse and continued until death, which occurred on the morning of the thirteenth day after injection.

Post-mortem examination of this animal revealed erosion ulcers in the mouth; ulceration and congestion of the fourth stomach; marked congestion and hæmorrhages in the duodenum, cæcum, colon, and rectum; and peritonitis and emphysema of the lungs.

In symptoms and lesions, this animal presented all the appearances of having died of rinderpest. Evidently, if any toxin was formed after the forty-eight-hour incubation period in the culture medium, it was so weak that it had no appreciable effect upon the animal injected and did not kill the virus in the medium or weaken its virulence.

Experiment 10.—This experiment differed from the preceding one in that the medium used was slightly acid in reaction to litmus and susceptible Timor cow 3292 was employed. The cow was injected subcutaneously at 3.15 p. m., November 10, 1911, with 900 cubic centimeters of Martin's broth, which had been inoculated with 50 cubic centimeters of defibrinated virulent blood from carabao 3241 and incubated at approximately 36° C. for forty-eight hours.

The animal showed no immediate ill effects from the injection, and did not show a rise in temperature nor display any of the symptoms of rinderpest up to the thirteenth day after injection.

The susceptibility of this animal was not proved, since it was accidentally killed before being tested.

From the results of this experiment, it is evident that if there was any toxin formed in the medium it was so slight as to have no ill effect upon the animal. It also appears as if the acid medium killed the virus, although there is no experimental

proof that this animal was susceptible. The fact of its susceptibility may be taken for granted, since it was one of fifteen Timor animals which were used at the laboratory and the other fourteen contracted rinderpest and died. The virulence of the blood used for inoculating the medium was checked up as shown in the preceding experiment.

Experiment 11.—In this experiment, 950 cubic centimeters of a 5 per cent potassium citrate solution were used instead of the Martin's broth. This solution was inoculated with 50 cubic centimeters of defibrinated virulent blood from carabao 3241 and incubated at approximately 36° C. for forty-eight hours.

The animal used was susceptible Timor cow 3296. It was injected subcutaneously at 3.30 p. m., November 10, 1911, with 900 cubic centimeters of this culture.

The animal suffered no immediate ill effects from this injection, and did not contract rinderpest. It was inoculated later with virulent blood, and was proved susceptible to rinderpest.

It is concluded from these results that either no toxin was formed in the potassium citrate solution or it was formed in such a small quantity that it produced no ill effects upon the animal. Also, the virus was not able to survive in it forty-eight hours under the conditions existing. The virulence of the blood used in this experiment for inoculating the medium was checked up as the results show in experiment 9.

Experiment 12.—In this experiment, Martin's broth was strongly alkaline in reaction to litmus paper. The animal used was susceptible Timor cow 3297. It was injected subcutaneously at 3.45 p. m., November 10, 1911, with 900 cubic centimeters of Martin's broth, which had been inoculated with 50 cubic centimeters of defibrinated blood from carabao 3241 and incubated at approximately 36° C. for forty-eight hours.

This animal presented no immediate ill effects from the injection. It developed a temperature on the sixth day after injection, diarrhoea on the tenth day, inappetence on the twelfth day, and died during the following night.

Post-mortem examinations revealed erosion ulcers in the mouth and a slight congestion of the fourth stomach and duodenum. The cæcum and colon were but slightly changed. The rectum was slightly congested and hæmorrhagic, and a slight peritonitis was present. The lesions were not so pronounced as those noted in the preceding autopsies.

From the results obtained from this experiment it is evident

that if there was any toxin formed in the medium after a forty-eight-hour incubation period it was so small in amount as to have no immediate ill effect upon the animal in question. From the incubation period, together with the symptoms and lesions presented upon autopsy, it is evident that the virus was not killed and that it had lost practically none of its virulence.

In addition to the experiments recorded in this article, three animals were injected in a similar manner with virulent rinderpest blood which had been incubated for three days. In each case, no ill effect followed the injection. It was concluded that in none of these cases was a harmful amount of rinderpest toxin produced, nor was there evidence that the rinderpest virus survived in the medium.

CONCLUSIONS

1. In the case of the two animals in experiments 3 and 5, that died in less time than the incubation period of rinderpest, after injection of the Martin's broth culture, the autopsy findings of the tissues indicated death from a bacterial infection and not from rinderpest. All evidence points to the conclusion that the Martin's broth employed in these two cases was contaminated by bacteria prior to injection in the animals. The results are attributed to poor aseptic technique, and greater care in the subsequent inoculations, where no such toxæmias were induced in the injected animals, support the conclusion.

The symptoms, lesions, and other circumstances stated by Baldrey resemble the results obtained in the two animals in question, and there is justification for belief that his results were due to the same cause.

2. In all the other animals injected with mixtures of blood and culture medium after incubation, no immediate ill effect followed, in either susceptible or immune animals.

3. With the exception of the animals noted in experiments 3 and 5, all those injected with the so-called twenty-four- and forty-eight-hour cultures of rinderpest in neutral or alkaline Martin's broth contracted rinderpest after the usual incubation period and died. These observations do not support Baldrey's belief that there occurs a rapid formation of rinderpest toxin in the broth during the twenty-four hours with resulting death of the virus. The experiments have included tests of Martin's broth after incubation as long as seventy-two hours.

Rinderpest virus does die in Martin's broth culture after

incubation for seventy-two hours, but there is no evidence that rinderpest toxin was formed, much less that rinderpest toxin caused the death of the virus.

5. The experiments reveal the fact that rinderpest virus will survive in neutral or alkaline Martin's broth at 37° C. for at least forty-eight hours, but not for seventy-two hours. Two cases were tested at twenty-four hours, 2 at forty-eight hours, and 3 at seventy-two hours.

6. Rinderpest virus kept in acid Martin's broth or in 5 per cent potassium citrate solution did not survive after forty-eight hours at 37° C.

KIDNEY-WORM INFESTATION OF SWINE IN THE PHILIPPINE ISLANDS WITH SPECIAL REFERENCE TO THE PATHOLOGICAL CHANGES

By WILLIAM HUTCHINS BOYNTON

(From the Veterinary Division, Bureau of Agriculture, Manila, P. I.)

Three plates

INTRODUCTION

Kidney-worm disease of swine is caused by an infestation with *Stephanurus dentatus* Diesing, 1839.¹ The infestation is characterized by muscular pains, tenderness to pressure over the kidneys, weakness, loss of appetite, emaciation, and partial or complete paralysis of the hind quarters. The parasites may be located in the fat surrounding the kidneys, in the ureters, and encysted in the kidneys, liver, spleen, lymph glands, and muscles and connective tissues in the region of the kidneys; also, they may be found free, slightly embedded, or encysted in the connective tissue of both peritoneal and thoracic cavities.

From the reports at hand, kidney-worm infestation appears to be more prevalent in subtropical and tropical climates than in the colder latitudes. It has been found in the United States, especially in the southern part. It is also present in South America, Australia, Asia, and in the Philippine Islands.

Observations upon the pathological changes induced by the worm in pigs imported into the Philippines form the basis of this paper.

The following description of the worm is taken from a bulletin written by Tayler² on this subject.

Sclerostoma.—Body cylindrical, tapering but slightly at each end; mottled in color; mouth terminal, circular, provided with six papillæ, of which the dorsal and the ventral are more prominent than the four submedian, and with numerous cillialike structures, about 35–40 in number. Cuticle thicker at extremities than in middle of body; transverse rings broader at extremities (9 μ) than in the middle (3 μ) of body. Opening of cephalic gland on ventro-median line near anterior end of esophagus. Alimentary tract

¹ Synonyms: *Sclerostoma pinguiicola* Verrill, 1870. Lard worm of pigs.

² 16th Annual Rep. Bur. Animal Ind. for 1899. Washington (1900), 612–637.

with distinct regions; buccal cavity ball-shaped, with ten enlargements at base; esophagus distinct, Indian-club shaped; stomach intestine greatly convoluted.

Male: 25 to 37 mm. in length by $1\frac{1}{2}$ mm. in width. Anus at caudal extremity. Inconspicuous rectangular bursa; lobes 6; dorsal 2, latero-dorsal 2, latero-ventral 2. Each half of bursa, 9 rays, arranged: dorsally 3, 1, dorso-lateral 3, ventro-lateral 2. Spicules 2, equal, saberform, ca. 0.8 mm. long; vesiculæ seminales 2; vasa deferentia 2, and testicles 2; each vas deferens with one testicle forming a long, white, convoluted tube about 26 mm. in length.

Female: 37 to 40 mm. in length by 2 mm. in breadth. Tail curved, obtuse, except for a conical tip. Lateral cuticular wings at caudal extremity. Anus ventral, 0.64 mm. from caudal extremity. Vulva 1 mm. forward from anus. Uteri 2, vagina bicornate. Ovaries 2, oviducts 2, each ovary with one oviduct forming a long, white, convoluted tube ca. 280 mm. in length. Oviparous; eggs oval, $56\ \mu$ by $100\ \mu$; shell thin and smooth.

THE INFECTION IN THE PHILIPPINES

I am indebted to Dr. R. W. Newcomb, veterinarian in charge of meat inspection in the Manila matadero, for data showing the extent of infestation and distribution of the disease among swine slaughtered in Manila. About 2,000 hogs were examined, of which very nearly 50 per cent were found infested. Of the animals slaughtered, approximately 20 per cent came from Batangas and Bulacan Provinces, respectively, 15 per cent were raised in Manila, while 10 per cent came from Cavite and Rizal Provinces, respectively. The remainder came from Zambales, Tarlac, Pampanga, and Nueva Ecija.

Dr. A. S. Shealy examined 43 animals in the same matadero, and found 50 per cent to be infected. A collection of lesions containing these worms was furnished to me, and has been useful in the preparation of this paper.

I have been afforded the opportunity of observing the effects of kidney-worm infestation among imported swine. The group of 20 pigs forming the nucleus of the drove consisted of 5 from Texas, 13 from Australia, and 2 from New Zealand. The importation began in 1906 with 5 from Texas.

The first definite diagnosis of kidney-worm infestation was found in a Berkshire sow imported from Australia on December 3, 1909. This animal died on December 3, 1911, two years after its arrival at the farm. A Berkshire boar (No. 10) imported from Australia in 1907 died on March 30, 1910. Upon inquiry, I was informed that this animal became paralyzed in its hind quarters shortly before death, which is a symptom of kidney-worm infestation.

From December 3, 1911, to April 22, 1912, covering a period

of four months and nineteen days, 6 Berkshire sows died, and all showed marked lesions of kidney-worm infestation, which was undoubtedly the cause of their death.

The animals were placed under the best sanitary conditions, being housed and kept on cement floors which were washed daily. The refuse was carried away through a sewer. Each compartment had a small runway for the animals to get out on the ground. They were not crowded, for very seldom over 5 or 6 animals were kept in the same pen at one time. None but the boar came in contact with native pigs. Shortly before a sow was ready to give birth to young, she was placed in a pen alone and kept there until the litter was old enough to wean. The only time during which a large number of pigs were together was after they were weaned. Those of nearly the same age were placed in a large pen by themselves. When they reached about 5 months of age, the animals to be kept for breeding purposes were taken out and the rest were disposed of.

SYMPTOMS

The first noticeable symptom is a stiffness of the movements of the animal as if it were suffering from muscular pains. This is especially perceptible in the hind limbs. As the disease progresses, the animal becomes lame and weak in the loins. During this stage, it lies down most of the time and does not rise to its feet unless urged. In some cases the animal loses partial or complete control of the hind quarters a few days before death. There is tenderness over the kidneys, as wincing occurs when pressure is brought upon these regions. The animal usually eats fairly well up to within a few days of death, when it refuses food entirely. Emaciation is generally observed, but the reverse was noticed in 2 animals which were in good condition at the time of death. Ascites was present in 3 of the 6 cases examined.

LOCATION OF THE WORMS

In the 6 animals examined, worms were observed in the following locations: Both free upon and deep in the fat surrounding the kidney, in the ureters, in the pelvis of the kidney (Plate I, fig. 4, *c*), and deep in the cortex and medulla of the kidney (Plate I, fig. 4, *d*); free in the peritoneal cavity, and often penetrating the peritoneum; free on the surface of the liver, embedded in the connective tissue around the large blood vessels of that organ, and in the liver tissue, either in accumulations or slightly embedded under the capsule, and deep in both portal

and mesenteric lymph glands; and in great numbers in the connective tissue along the back, especially in the neighborhood of the kidneys. In 2 cases, the connective tissue along the spinal column extending from the coccyx to the diaphragm was a mass of worm tracts, most of which contained one or two worms and purulent material. In 3 cases, worms were found free in the thoracic cavity and embedded in the pleura. One worm was penetrating the lung tissue. Some were embedded in the diaphragm. Thus it will be seen that, when an animal dies of kidney-worm infestation, the disease presents a generalized instead of a localized aspect.

Several writers state that the worm is never found in the internal structure of the kidney. This may be true in those cases noticed in the abattoirs where the infestation is not of long standing, but if one examines animals which have died of the disease he will find the kidney structure to be invaded in a majority of cases.

MORBID ANATOMY

One of the most prominent changes to be noted at autopsy is the rapidity with which the internal organs undergo post-mortem changes. Four of the 6 animals were examined shortly after death. The viscera of these animals had a disagreeable odor as if decomposition was well advanced. Changes in the various organs were observed as described below.

LIVER

In every case, the liver was enlarged, soft, and of a dark purplish color. The borders of the lobes instead of tapering down to a rather thin edge were distended and rounded. In some instances, collections of gas bubbles were noticed under the capsule, suggesting that putrefaction was taking place rapidly. The dependent portions of the lobes of the liver were of a uniform dark purplish color, and the individual lobules were not distinguishable through the capsule. The upper portion of the lobes had a mottled appearance. The majority of the lobules in some cases were dark purple, while the remaining lobules varied from a purplish tint to gray-brown. Upon section, the parenchymatous tissue was soft and bulged out on the incised surface, and the borders of the lobules were indistinguishable. The lobes adhered to each other by a gray, feltlike fibrinous exudate. This was especially prominent in the dependent portions. In 3 cases, the liver was adherent to the diaphragm, sternum, and stomach.

Several parietal thrombi were found in the branches of the hepatic veins (Plate I, fig. 2, *b*). The largest one noticed measured 1.9 centimeters in length, and filled approximately half of the vessel. These thrombi are undoubtedly the principal agents which cause the enormous passive congestion in the liver by damming back the blood in the hepatic system.

The walls of the main branch of the portal vein and vena cava in some cases were considerably thickened, and possessed worm tracts which were surrounded by fibrous connective tissue and which contained worms or a mass of purulent material. These worm tracts furthermore extended into the liver substance, replacing the parenchymatous with fibrous tissue. In 2 cases, large accumulations of worm tracts were found in the regions where the lobes join and on the posterior surface. Each of these accumulations was surrounded by considerable connective tissue. The largest of them measured 10.5 by 4.5 centimeters, and hence extended a considerable distance into the liver substance. In the immediate vicinity of these accumulations, isolated tracts were found. The individual tracts varied from 1 to 2 millimeters in diameter, and the walls were made of a gristlelike substance which in turn was surrounded by connective tissue.

KIDNEYS

The kidneys like the liver showed a marked deviation from the normal. A photograph of a kidney from pig A-18 is shown in Plate I, fig. 3. This kidney measured 15.5 centimeters in length and 6 centimeters in diameter. A retention cyst (Plate I, fig. 3, *a*) was present on the external surface of the anterior end, and measured 3 by 2 centimeters. It was somewhat triangular in shape, the apex projecting toward the pelvis of the kidney. The outer wall of the cyst was denuded of parenchymatous tissue, was composed of tough, fibrous connective tissue, and was set rather deep into the substance of the cortex. It is questionable whether the worms were the cause of the cyst formation. However, retention cysts were present in the kidneys of 3 of the 6 hogs examined. Scattered over the surface of the kidney were several uneven dark-purplish indentations, which were apparently the scars of small healed abscesses. The surface of the kidney was not uniform in color, but presented the appearance of being injected with fine, irregular, reddish brown lines forming a multitude of grayish brown blotches, averaging 1 millimeter in diameter. The capsule of this kidney stripped easily. The retention cyst contained a turbid semiviscid fluid. The internal surface of the wall of the cyst was composed of smooth, fibrous

connective tissue. On section, the cortical substance was gray, with brownish red streaks and blotches following the uriniferous tubules down into the medulla. The medullary substance was similar in appearance to the cortex. The papillæ had a congested appearance, and were slightly swollen. The pelvis contained a large amount of gelatinous and purulent material. Two worms were found embedded in this purulent material.

The left kidney from pig A-21 measured 11.5 by 5.5 centimeters. A retention cyst was present on the external surface of the posterior end, and measured 1.7 by 1.3 centimeters. It was deep set in the tissue, and was covered by a thin fibrous capsule. This kidney had several deep notches on its surface, apparently scars from former abscesses or cysts, which gave the kidney a shrunken, uneven appearance. It was of a uniform grayish brown color, and the capsule was easily removed.

The right kidney from pig A-14 measured 12 by 5.5 centimeters. The capsule was easily removed. The kidney was of a bluish gray color, and was of soft consistence. The external surface was perforated with numerous small holes, averaging about 0.5 millimeter in diameter, which gave the kidney externally a porous appearance. This was due undoubtedly to rapid post-mortem changes. The inner surface was somewhat flattened, having a large scar near the center. Two worms protruded from the cut end of the ureters. A large amount of yellowish white purulent material escaped from the ureter when it was cut.

On sectioning the kidney through its longitudinal axis, the internal structure, especially the cortex and medulla, had the appearance of a sponge. It was perforated with holes and pits, varying from 0.5 to 3 millimeters in diameter. (Plate I, fig. 4, *a* and *b*.) Practically all the parenchymatous tissue was destroyed, leaving merely the connective tissue framework. This appearance was particularly prominent in the posterior two-thirds, while the anterior third was badly affected, but not to such a marked extent. The cortex and medulla were gray, except on the borders of the papillæ, where the medulla was brownish. Many of these changes were undoubtedly due to rapid decomposition. The papillæ were brownish in color, and contained a few pits or vacuoles.

The calix minor and calix major were brown and considerably distended. Three worms were coiled up in the pelvis of the kidney, and, as mentioned above, there were 2 in the ureters, thus bringing to view 5 worms in this particular kidney in one section.

A section through the apparent scar on the flattened inner surface of this kidney revealed an area 2.8 by 1.9 centimeters, composed of fibrous connective tissue, and containing 9 worm tracts varying from 3 to 5 millimeters in diameter. Five worms were found in these tracts. This area was located principally in the medulla, a part of it extending up into the cortex. In all, 8 worms were found in this kidney and 2 in its ureter.

LYMPH GLANDS

In every case examined, the portal and mesenteric lymph glands were enlarged, one of average size measuring 5.5 by 2.3 centimeters. As a rule, in the early stages they were soft in consistence, but became indurated in the older lesions. The external surface of the glands which had been infested for some time and had become indurated was very uneven. Small protuberances extended up from the surface of the glands, where the worms had embedded themselves in the capsule.

On sectioning, the indurated glands were cut with some difficulty. The cut surface presented different appearances, depending upon the extent to which changes had taken place.

In the early stages, the glandular structure had a congested reddish appearance throughout. However, this was most prominent along the borders of the capsule and the trabeculæ. In the next stage, the capsule and trabeculæ were considerably thickened. The internal glandular structure was colored gray, except along the border of the thickened capsule and trabeculæ, where it was dark red from the congestion and blood pigment present.

Tracts either containing worms or filled with purulent material were found especially in the thickened capsule and sometimes extending into the larger trabeculæ.

A few glands were found in which practically the entire parenchymatous structure had become transformed into connective tissue intermingled with worm tracts which contained either worms or a mass of round cells and tissue detritus.

ABDOMINAL CAVITY

Ascites was present in 3 of the cases examined; namely, A-21, A-27, and A-18. In A-21 there were between 3 and 4 liters of blood-stained fluid. The small and large intestines were one mass of adhesions. The intestinal walls were oedematous, and the mucous membrane was highly congested throughout.

In the other 2 cases there was not as much ascitic fluid

present; however, the intestines were œdematous and adherent as in A-21.

LUNGS

More or less pleurisy was present in all 6 cases. The lobes adhered to each other and in some instances to the thoracic wall. In 3 cases, kidney worms were found in the thoracic cavity, but, as the bronchioles in every case contained large numbers of worms belonging to the genus *Metastrongylus*, it is rather difficult to decide whether the pleurisy was caused by them or by *Stephanurus dentatus*.

MICROSCOPICAL EXAMINATION OF INFESTED ORGANS

The tissue under consideration was fixed in both Zenker's fluid and formalin, and paraffin as well as frozen sections were made. The sections were stained with Ehrlich's acid hæmatoxylin and by Van Gieson's method, using Ehrlich's acid hæmatoxylin and picrofuchsin. Sections revealed the following conditions:

KIDNEYS

The kidney tissue showed a pronounced passive congestion. The veins and capillaries between the tubules in both cortex and medulla were distended with blood. In some instances, a considerable amount of congestion was present in the glomeruli. Since the arteries were practically empty, undoubtedly the congestion of the glomeruli was due to the enormous passive congestion which dammed the blood back in them.

Parenchymatous degeneration was present in all stages of development and scattered diffusely throughout the cortical and medullary substance. Numerous casts were present in the convoluting and collecting tubules (Plate II, fig. 2, *a*). These casts had all the appearances and staining reactions of colloid material, for instance giving a homogeneous orange-red color, when stained with hæmatoxylin and picrofuchsin.

Numerous parenchymatous cells were noticed undergoing colloid degeneration. They presented different appearances, depending upon the extent to which the degeneration had taken place. In the earliest stage noticeable, the cell body took a lighter stain and was very finely granular. In the next stage, small spherical droplets, which took an orange stain with hæmatoxylin and picrofuchsin (Plate II, fig. 3, *a*), could be noticed scattered throughout the cell body. As the degeneration progressed, the droplets became larger and finally occupied the entire cell body (Plate II, fig. 3, *c*). Finally, they burst out into the lumen of the tubule, and eventually coalesced to form casts (Plate II, fig.

2, b). The nuclei retained their staining power remarkably, as will be noticed in Plate II, fig. 3, d. Although the cell body had become completely broken up into droplets, the nucleus stained almost as perfectly as in a healthy cell. The nuclei did not become destroyed until after they had flowed into the lumen of the tubule.

All the parenchymatous tissue was not affected in this manner. The degeneration occurred in areas, involving from 4 to 8 or more tubules, and was more prominent in the cortex than in the medulla. Frequently, there were accumulations of round cells which had the appearance of lymphoid tissue and took the hæmatoxylin stain deeply. These cells were either scattered through, or were in the immediate vicinity of, the degenerating areas.

An occasional glomerulus was found, in which the space between the outer and inner capsule was filled with homogeneous colloid-appearing material. As the glomerular tissue and capsule showed no apparent degeneration, this colloid material must have been forced into the cavity through the constricted neck of the convoluted tubules. The marked passive congestion was undoubtedly instrumental in the retrograde flow of this material.

Sections made from the kidney represented in Plate I, fig. 4, showed that there was practically a complete destruction of the parenchymatous tissue in both the cortex and medulla. The lining connective tissue framework of the tubules could be seen practically denuded of parenchymatous tissue. The spaces were either empty or filled with cell detritus mixed with a faintly staining, colloidlike substance, which showed complete destruction of the functional tissue in that particular specimen.

LIVER

The most striking appearance in the liver on microscopical examination was the marked passive congestion present. This varied in degree in different portions of the organ.

As a rule, sections made from the upper portions of the lobe showed the portal vein to be distended with blood, practically all the interlobular capillaries were congested, and the central vein was distended. The liver cells generally showed slight parenchymatous degeneration. In the interstitial tissue, there was usually an abnormal number of leucocytes present, especially small lymphocytes, and to a lesser extent eosinophiles. Leucocytes were also seen in the interlobular capillaries, working their way through the capillary walls and invading the individual liver cells.

The next and most spectacular stage of congestion was noted in the lower portions of the lobes. The portal veins were usually distended with blood, the interlobular capillaries around the edges of the lobules were markedly congested, while in the central portion of the lobules around the hepatic vein (Plate II, fig. 1, *a*) the congestion reached such a degree as to cause rupture of the capillaries. These markedly congested and hæmorrhagic portions varied from one-fourth to three-fourths of the area of the involved lobules. The parenchymatous tissue in these regions had practically disappeared. Now and then a liver cell was present which had not as yet undergone necrosis. The parenchymatous tissue around these areas was found in all degrees of degeneration, being mildest near the capsule of the lobules. An abnormal number of round cells and eosinophiles were found in the capsular tissue, also penetrating into the parenchymatous tissue, and surrounding the individual liver cells. In a few instances, bile ducts were noticed undergoing proliferation in this area.

The next stage noticed was that in which the lobules had become necrotic and were filled with blood from hæmorrhages. These areas were most frequently met with at the extreme dependent portions of the lobes (Plate I, fig. 1, *a*). The hæmorrhagic areas contained large numbers of round cells and eosinophiles. The capsule was congested and infiltrated with leucocytes. The connective tissue of the capsule showed signs of degeneration, especially infiltration with a granular, fibrinous exudate.

In those areas of the liver which the worms had invaded, marked pathological changes were encountered. Sections of worms were frequently found. Surrounding the worm was an accumulation of leucocytes and cell detritus, external to which was a fibrous connective tissue wall. More frequently the track of the worm was found, which was represented by a round or oblong mass of cell detritus mixed with round cells and fibrin, and surrounding this mass of material was the fibrous connective tissue wall.

In the immediate vicinity of these invaded areas, there was marked development of connective tissue. In many instances, the interlobular connective tissue had developed to such an extent as to crowd the lobules out of existence. In some instances, lobules were found varying from three-fourths to one-fifth of their normal size. The liver cells were atrophied, from the pressure brought on them by new-forming connective tissue. The most

embryonic type of connective tissue and the youngest blood vessels were found around the edges of the lobules, while the connective tissue which extended out from the edges appeared to be older; this showed that it was encroaching upon the parenchymatous tissue and crowding it out. Large numbers of round cells and eosinophiles were present along the borders of the lobules, and a few were scattered throughout the new-forming connective tissue.

From the foregoing, it is evident that the worm produces an irritation which gives rise to proliferation of connective at the expense of parenchymatous tissue, the former causing pressure upon, and atrophy and degeneration of, the latter.

There was also marked proliferation of the bile ducts in these areas. They developed in some instances to such an extent as to present the appearance of an adenoma. In those areas in which the parenchymatous tissue had been completely obliterated by the intruding connective tissue, many of the numerous blood vessels which were formed during the development of the connective tissue had undergone thrombosis. Thrombi in all stages of organization were found. In many instances, these thrombi appeared as cords of connective tissue completely occluding the small vessels.

In those areas which the worms had but recently invaded, the fibrous connective tissue capsule surrounding them was found in different degrees of development. The earliest stages showed merely a few cells of new-forming tissue, rich in blood vessels and infiltrated with a large number of leucocytes. In the older lesions, there was a well-defined, thick wall of connective tissue. The liver tissue around the newly infested parts showed a marked passive congestion. Also, the liver cells in these areas were shrunken to a perceptible extent from pressure caused by dilated capillaries, and they showed various grades of degeneration.

LYMPH GLANDS

Various appearances were noticed in the lymph glands according to the extent to which they had undergone pathological changes. The earliest change was an active congestion. The cortical follicles, especially in the neighborhood of the lymph sinuses, were markedly congested, and merged in many instances into hæmorrhagic areas. The cortical substance was distended. The lymphoid tissue was scattered, and the intervening spaces were filled with blood. In the medullary portion of the glands, the tissue was distended and loose, except the lymphatic cords

which in most cases held their closely packed appearance. The medulla was likewise markedly congested, and in some instances hæmorrhagic.

The next stage showed a thickening of the capsule and trabeculæ, with pronounced congestion, hæmorrhages, and even necrosis of the follicular substance. Thrombi were frequently found in the blood vessels. In Plate II, fig. 4, *c*, is shown a large thrombus in an artery located in the trabeculæ. This particular thrombus had almost occluded the vessel, and was of the mixed type. The vessel walls, *b*, and the trabeculæ, *d*, were thickened.

In some of the glands thus affected, one or more worms were embedded in the capsule, passing down into the connective tissue of the trabeculæ.

As the infestation persists, the worms work their way into the substance of the gland. They cause an irritation which brings on an active inflammation, resulting in the formation of a connective tissue capsule around the worm tract. In the course of time, the entire glandular substance is replaced by connective tissue, and the refuse is left by the worm. A section from the lymph gland is represented in Plate III, fig. 1, in which practically all the glandular substance has been replaced by worm tracts and fibrous connective tissue.

Worms were found repeatedly in the glands. They were surrounded by leucocytes, most of which were small lymphocytes intermixed with cell detritus and fibrin. The tract wall was made up of proliferating connective tissue which contained numerous new-forming blood vessels, both single and ramified. Large numbers of round cells and eosinophiles were scattered throughout the proliferating connective tissue, and were especially abundant in the borders of the tissue next to the worm.

A tract apparently occupied by a worm is shown in Plate III, fig. 1, *a*. It is composed of fibrin, degenerated cells, and small round cells. This tract is surrounded by a connective tissue capsule, *b*, which contains a large number of new-forming and ramified blood vessels, *c*. These vessels are practically all distended with blood. A large number of leucocytes and eosinophiles are scattered throughout the connective tissue. A worm tract which is of longer standing than the one shown in Plate III, fig. 1, *a*, is represented in Plate III, fig. 1, *d*. The contents of this tract are made up of fibrin, cell detritus, and leucocytes. There is a layer immediately around this (fig. 1, *e*) which takes a pinkish red stain with eosin, which suggests

early calcification because of its homogeneous appearance and which contains a large amount of cell detritus. Immediately around this zone is the capsule, *f*, made up of rather old and well-formed connective tissue. Hence it appears that this worm tract has been present for some time. A still older tract is shown in Plate III, fig. 1, *g*, in which the central part has become a granular mass of broken down and degenerated cells. The zone which bounds this central mass, *h*, stains a rather deep red with eosin; it is homogeneous, and has all the appearances of a calcified mass. The zone, *i*, surrounding this is made up of old fibrous connective tissue which forms the wall of the tract.

SUPPLEMENTARY OBSERVATIONS

Since the completion of the preceding general description of lesions, two animals, Berkshire sows A-17 and A-25, have died of kidney-worm infestation.

Animal A-17 was 4 years 8 months and 6 days old when she died. She aborted about three weeks prior to death, and had seemed unthrifty for some time. Death occurred in the evening of October 27, but the autopsy was not made until the following morning.

Post-mortem changes were well advanced. The viscera had a pungent repulsive odor. The peritoneal cavity contained a large amount of blood-stained fluid. The liver was markedly distended, soft, of a purplish color, and contained collections of gas bubbles under the capsule. The lobes were slightly adherent to each other at their dependent portions by a grayish feltlike exudate.

The small intestines and especially the colon were œdematous and slightly adherent by a fibrinous exudate. The mesenteric lymph glands were enlarged and in some instances slightly indurated.

The right kidney measured 16 centimeters in length, 9 centimeters in width at its anterior end, and 6.5 centimeters in width at its posterior end. It was 5.5 centimeters in thickness at the anterior end and 4 centimeters at the posterior end. A retention cyst 5.5 by 4 centimeters, which projected 1.5 centimeters above the surface, was present at the anterior end. This retention cyst was denuded of parenchymatous tissue on its upper surface, being covered only by a fibrous connective tissue capsule. At the tip of the posterior end, the capsule was adherent to a scar tissue on the kidney. This scar measures 3 by 1.5 centimeters.

On sectioning this kidney, an oval encapsulated abscess, 1.3 by

1.5 centimeters, was found at the posterior end, and extended through the cortex into the medullary substance. Considerable degeneration of the parenchymatous tissue was present in the vicinity of this abscess. Two worms were found in the upper part of the ureters. Worm tracts either containing worms or empty were found located along the edges and between the papillæ throughout the entire organ. These tracts were all similar in structure, and varied from 1 to 1.5 millimeters in diameter.

The left kidney measured 15 centimeters in length, 6.5 centimeters in width at its posterior end, 8 centimeters at its anterior end, and was 3.5 centimeters in thickness.

In the central portion above the hilus, a scar 2.5 by 1.5 centimeters was found. At the posterior end, the capsule was adherent to a scar 4 by 1.5 centimeters. On section, 2 worms were found embedded in the hilus.

Numerous worm tracts, either containing worms or filled with purulent material, were found in the connective tissue located along the spinal column in the vicinity of the kidneys.

Pleurisy was very evident. The lobes of the lungs were adherent to each other, to the costal pleura, and to the diaphragm. Several worms were found free in this cavity, and 2 were embedded in the costal pleura.

The pericardial sac contained a large amount of blood-stained fluid. The heart and pericardium were covered with a thick feltlike fibrinous exudate, and were adherent to each other. The heart and pericardium presented the appearance of the marked traumatic pericarditis which is sometimes found in cattle. Five worms were found at the base of the aorta.

Worms were found free and embedded in both pleural and peritoneal cavities. Twenty-eight were picked up which were lying free among the organs.

Berkshire sow A-25, age 4 years 3 months and 21 days, died during the night of August 13, 1913.

On looking over the history of this animal, the following may be summed up. During her life, she aborted once and gave birth to 32 pigs of which 14 lived. From these figures, it will be noted that this animal was not profitable for breeding purposes.

AUTOPSY

The animal was large and from external appearances in fairly good condition. Upon autopsy, a large amount of clotted blood and dark blood-stained liquid was present in the peritoneal cavity. This appearance sug-

gested that the immediate cause of death was from an internal hæmorrhage. The source of the hæmorrhage was found to be from a large aneurysm of the anterior mesenteric artery which had ruptured. This aneurysm is represented in Plate III, fig. 2. The anterior end, *a*, lay in close proximity to the posterior aorta. It measured 24 centimeters in length and 34.5 centimeters in circumference around the largest portion. Near the posterior end there was a slight constriction, *f*, which may be considered as dividing the lesion into two aneurysms, a large anterior and a small posterior; however, the constricted portion was not composed of normal tissue. The tunica adventitia was markedly roughened by outgrowths of fibrous connective tissue and nodules. These nodules (Plate III, fig. 2, *e*, and fig. 3, *a* and *b*), of which 11 were easily seen on the surface of the specimen, were composed of fibrous connective tissue. They protruded above the surface on an average of 0.6 centimeter, and varied from 0.5 to 0.9 centimeter in diameter. The longest nodule measured 3.5 centimeters in length, and formed a tortuous course. The majority were about 1.5 centimeters in length, giving them an oval appearance. These nodules either contained kidney worms (Plate III, fig. 3, *a*), in which instance a worm can be seen projecting from the cut end of a nodule, or they were filled with a mass of cheeselike material. The tunica adventitia was very thin, being made up of merely a superficial layer of connective tissue in places. The endothelial lining and tunica intima had entirely disappeared and their places were taken by a thick layer of fibrinous material varying from 0.3 to 2.6 centimeters in thickness, which coated the entire aneurysm. This fibrinous material (Plate III, figs. 2, *c*, and 3, *c*) was yellowish white, firm in consistency, and tough, thus forming a protective coat over the inner surface of the aneurysm.

A large parietal thrombus was present in the aneurysm (Plate III, fig. 4). Two kidney worms were embedded in this thrombus, *b* and *1b*, and one worm was found with its body partially protruding into the cavity of the aneurysm, a portion of the body still remaining embedded in the wall. These facts show that the kidney worm is capable of working its way through the wall and into the lumen of a blood vessel.

The appearance of the lesion just described suggests that by penetrating the wall of an artery the kidney worm is capable of producing an inflammation of the muscular coats, which may cause them to lose their tone. As a result of the constant high blood-pressure and weakened vessel walls, they were stretched and unable to regain their normal size, the ultimate result being the formation of the aneurysm. The heavy coating of fibrinous coagulated material undoubtedly arose from the endoarteritis, which may have been caused directly by the irritating effect of the worms upon the endothelial layer or by the extensive stretching of the weakened muscular walls of the blood vessel.

The aneurysm thus formed corresponds in many ways with the aneurysm found in horses infested with *Strongylus armatus* (*Sclerostoma equinum*). In the horse, the immature worm causes the aneurysm while in kidney-worm infestation mature worms were found.

In this animal, there was a generalized infestation. Worms were found both free and encysted in the thoracic and peritoneal cavity. Three worms were found in the right kidney, 2 of which were coiled in the calix and 1 embedded in the medulla.

The lesions present in these animals go further to prove that kidney-worm infestation becomes a generalized disease if allowed to run its course. They also show how detrimental the disease may be to a drove of breeding animals. It not only kills off the older breeding animals, but may cause them to abort. In some instances it has been noticed that sows die soon after giving birth to a litter of young, causing the loss of the entire litter or stunting them to such an extent that they will never be as large animals as those from a healthy mother. Also, there is a possibility that the entire litter may become infected from the mother.

MEDICAL TREATMENT

Since the worms are embedded in the solid tissues and are surrounded by purulent débris, treatment with vermicides introduced by the mouth is absolutely unsatisfactory. Remedies never could be expected to reach the worms in sufficiently concentrated form to have any beneficial action. Hence preventive measures are of more than usual importance.

PREVENTION

Various investigators have come to the conclusion that the worm passes no part of its life cycle in any other animal than the pig. Therefore, every effort must be made to break the chains of succession in the reproduction of the worm by not allowing uninfested animals to come in contact with infested ones or with their excretions.

Law³ states that—

Hogs should be excluded from all ground known to be infested, or on which infested hogs have been, or which receive drainage from fields, lots or pens occupied by other hogs; * * *. Above all the pigs should be kept apart from slaughter houses and streams into which they drain and on no account should they be allowed the offal or flesh of other pigs, including scraps from the kitchen, unless the material has been thoroughly cooked. * * * As in the case of other communicable diseases of pigs, the massing of these animals in large herds in contaminated localities is particularly dangerous. * * * Purchased pigs should only be added to sound herds on the basis of irrefragible evidence of the soundness of the herds and localities from which they come, and even then only after quarantine.

The only way the disease can be controlled to any extent is by placing the pigs on slat floors, which allow the urine and fæces to drain through. In this way, the uninfested animals are not so apt to come in contact with infective material.

³ *Veterinary Medicine*, 2d ed. (1909), 5, 542.

SUMMARY

1. From the specimens procured from hogs by me and from identification of the same by H. B. Ransom, it is proved that the animals were infested with *Stephanurus dentatus*.

2. From observations made by R. W. Newcomb and by A. S. Shealy on native hogs killed at the matadero in Manila and from identifications made by me of specimens collected by them from about 25 cases, it is proved that *Stephanurus dentatus* infestation is prevalent among the native pigs slaughtered there.

3. The age at which pigs usually die from infestation with *Stephanurus dentatus*, as observed by me, and the lesions produced by this worm indicate a slow-developing, chronic disease.

4. Since the average age of pigs that are killed for meat at the Manila matadero varies from six months to one and a half years, the disease does not have time to cause any fatal or very damaging lesions in the animals. Hence it is not looked upon as very serious in connection with meat inspection. In older animals, the lesions are more serious.

5. From the several autopsies made on animals, it is concluded that kidney-worm infestation becomes a generalized instead of a localized disease of swine when allowed to run its course. Practically every cavity of the body may become infested.

ACKNOWLEDGMENT

The writer is indebted to Mr. H. B. Ransom, chief, zoölogical division, Bureau of Animal Industry, Washington, D. C., for identification of the parasite and other information.

Dr. R. W. Newcomb and Dr. A. S. Shealy assisted in collecting information and material for study.

Mr. L. J. Fattey, foreman on the Alabang stock farm, furnished the history of several animals mentioned in this paper and promptly notified me in cases where animals were either sick or dead.

ILLUSTRATIONS

PLATE I

- FIG. 1. Section of liver from a pig infested with kidney worms.
- a*, markedly congested lobule in the dependent portion of a lobe.
 - b*, a worm tract in the interstitial tissue.
 - c*, an accumulation of worm tracts.
 - d*, a marked development of interstitial tissue from the chronic productive inflammation which has practically replaced the parenchymatous tissue.
2. A section of liver from a pig infested with kidney worms and which shows thrombus formation.
- a*, hepatic vein.
 - b*, a parietal thrombus measuring 1.9 centimeters in length and filling approximately half of the vessel.
 - c*, worm tracts in the immediate vicinity of the vessel wall which are surrounded by connective tissue.
 - d*, worm tracts deep in the liver substance, replacing the parenchymatous tissue with fibrous connective tissue.
3. Kidney of a pig infested with kidney worms.
- a*, large retention cyst.
 - b*, scars on the surface of the kidney.
 - c*, the mottled appearance over the surface of the kidney.
4. Transection of a kidney from a pig infested with kidney worms.
- a*, cortical portion of kidney, presenting perforations undoubtedly caused by post-mortem changes.
 - b*, medullary portion of kidney presenting the same porous appearance.
 - c*, kidney worms coiled up in the pelvis of the kidney.
 - d*, a kidney worm penetrating the medullary portion of the kidney.
 - e*, an accumulation of worm tracts in the pelvis of the kidney.
 - f*, worm tracts extending into the medullary portion of the kidney.

PLATE II

- FIG. 1. Microphotograph of the liver from a pig infested with kidney worms.
- a*, hæmorrhagic areas around the hepatic vein, showing marked passive congestion.
 - b*, interstitial tissue somewhat thickened.
2. Microphotograph of the kidney, from a pig infested with kidney worms.
- a*, casts present in the convoluting and collecting tubules.
 - b*, formation of casts in the tubules.
 - c*, the breaking up of the parenchymatous cells and the extrusion of colloid material into the lumen of the tubules in the formation of casts.

FIG. 2 —Continued.

- d*, degeneration of the parenchymatous cells; primary step in the formation of the casts.
3. Highly magnified microphotograph of a section of the kidney from a pig infested with kidney worms.
- a*, parenchymatous cells, containing minute spherical droplets of colloidlike material.
- b*, droplets of colloidlike material, bursting out of the cells and beginning to accumulate in the lumen of a tubule.
- c*, cells, the cell bodies of which have undergone complete degeneration and are filled with droplets of colloidlike materials.
- d*, the nuclei of cells which have undergone degeneration and still retain their staining properties.
- e*, the lumen of a tubule practically filled with droplets of colloidlike material which have not coalesced.
- f*, casts formed in the tubules from the droplets extruded by the parenchymatous cells. It will be noted that the tubules in which these casts are located are practically denuded of their epithelium.
4. Microphotograph of a section of a lymph gland, showing thrombus formation from a pig infested with kidney worms.
- a*, lymphoid tissue.
- b*, thickened wall of blood vessel.
- c*, obturating thrombus in the artery.
- d*, thickened trabeculæ.

PLATE III

FIG. 1. Microphotograph of a section of a lymph gland containing a worm tract, from a pig infested with kidney worms.

- a*, worm tract filled with fibrin, cell detritus, and leucocytes.
- b*, newly formed fibrous connective tissue capsule around a worm tract.
- c*, newly formed blood vessels in the fibrous connective tissue capsule.
- d*, a worm tract of longer duration than that of (*a*), containing fibrin, cell detritus, and leucocytes.
- e*, a homogeneous zone, suggesting calcification.
- f*, well-formed connective tissue capsule.
- g*, an old worm-tract, containing a granular mass of material.
- h*, a calcified zone.
- i*, a well-formed old connective tissue capsule.
2. An aneurysm of the anterior mesenteric artery.
- a*, anterior end of the mesenteric artery in close proximity to the posterior aorta.
- b*, distal end of mesenteric artery.
- c*, a section in the wall of the aneurysm, showing its thickness, most of which is composed of a coagulated fibrinous mass.
- d*, the area from which the hæmorrhage took place.
- e*, nodules on the surface of the aneurysm, containing either kidney worms or cell detritus.
- f*, a constriction which divides the lesion into a large anterior and small posterior aneurysm.

FIG. 3. A portion of the aneurysm.

a, a nodule in the wall of the aneurysm, from which a kidney worm is protruding.

b, nodules in the wall of the aneurysm.

c, thick fibrinous coagulated material, which formed a coating over the entire inner surface of the aneurysm.

d, the thin tunica adventitia.

4. The thrombus which was present in the aneurysm.

a, the body of the thrombus.

b and *1b*, two kidney worms embedded in the thrombus.



Fig. 1. A section of the liver.

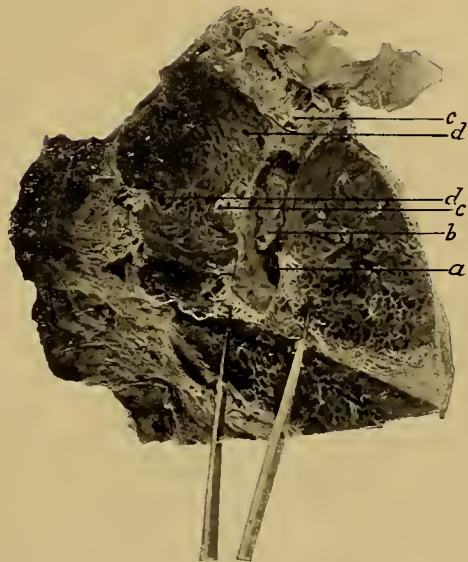

Fig. 2. A section of the liver.



Fig. 3. An infested kidney.

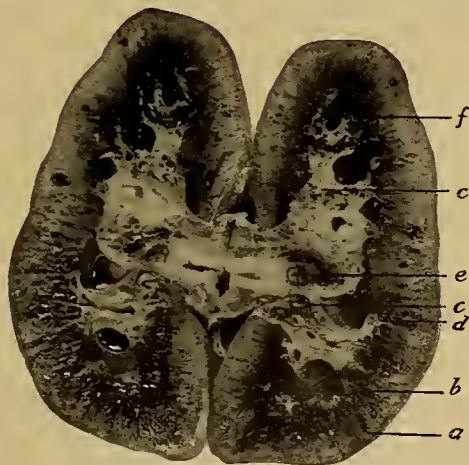

Fig. 4. A transection of an infested kidney.

PLATE I. KIDNEY-WORM INFESTATION OF SWINE.



Fig. 1. A microphotograph of the liver.

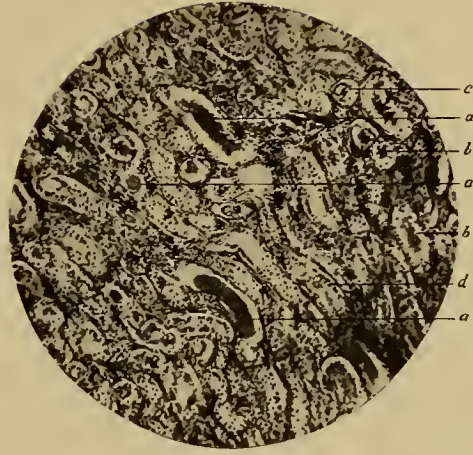

Fig. 2. A microphotograph of the kidney.

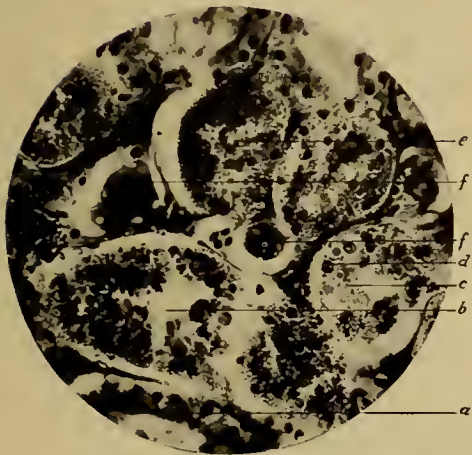

Fig. 3. A microphotograph of the kidney.



Fig. 4. A microphotograph of a lymph gland.

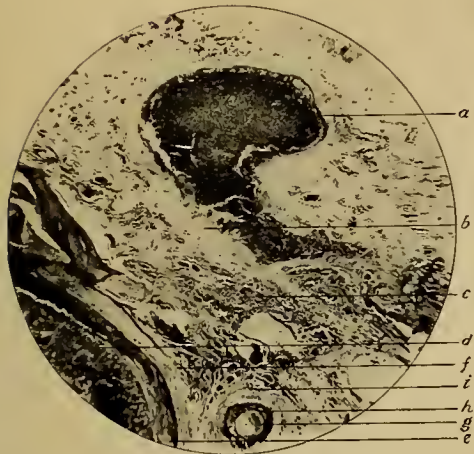

Fig. 1. Section of a lymph gland.

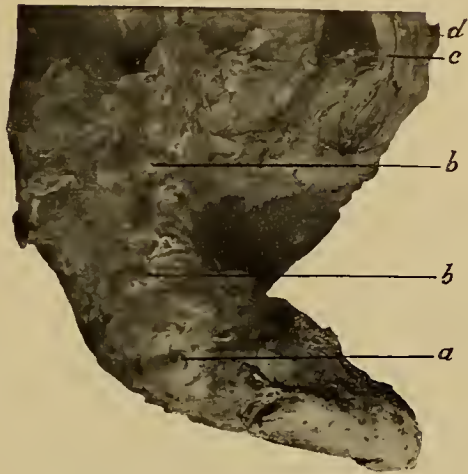

Fig. 3. A portion of the aneurysm.



Fig. 2. An aneurysm of the anterior mesenteric artery.



Fig. 4. The thrombus which was present in the aneurysm.

ANOTHER DANGEROUS JELLYFISH IN PHILIPPINE WATERS

By S. F. LIGHT

(From the Zoölogical Laboratory, College of Liberal Arts,
University of the Philippines)

During the stay of the biological survey party of the University of the Philippines and the Bureau of Science in Taytay, Palawan, in 1913, one of the women of the party was severely poisoned by the sting of a jellyfish hitherto not specifically reported as dangerous. A number of specimens of this medusa were procured, and since returning to Manila I have been able to indentify it as *Chiropsalmus quadrigatus* Haeckel, a species named by Haeckel from a specimen collected at Rangoon. Mayer¹ has recently redescribed it from specimens collected by the United States Bureau of Fisheries ship *Albatross* in various parts of the Philippines.

It was unfortunate that there was no doctor in the party to preserve an accurate and technical account of the symptoms, but I give the following untechnical description in the hope that it may be at least of general interest to medical men in the Islands.

The stings were inflicted on the feet and legs, the long and delicate tentacles wrapping several times around the legs and breaking from the body of the medusa. These tentacles, bearing tens of thousands of minute nettling cells, clung to the skin, and wherever they touched a purplish swollen ridge appeared within a few seconds. Within a few hours, each of these ridges was marked by a continuous blister, and although these were opened several times they persisted for about a week. The red marks which were left wherever the tentacles had touched the skin were still very distinct, some four months after the sting was inflicted. This bears out the statements of the people of Palawan, who say that these marks always persist for six months or even more. Swelling of the legs and feet began almost immediately, and persisted for from seven to eight weeks, the person stung not being able to walk because of this swelling. About ten minutes after the sting was inflicted, general muscular spasms ensued. Those of the respiratory muscles began after about

¹ Medusae of the World (1910), 3, 516.

twenty minutes and were especially severe, making breathing very difficult at times. In about half an hour the heart action became very feeble, and the patient was semiconscious for a period of about fifteen minutes, during which time the pulse could be detected with difficulty. Although the patient had been given 3 doses of whisky, it was thought necessary to administer by mouth a dose of $\frac{1}{60}$ grain of strychnine, after which the heart action improved.

The pain from the sting was immediate and severe, and probably because the surface affected was so great seemed general in the feet and legs, the patient saying that it was like the pain of a very severe burn. The patient was confined to bed for five days, and found it difficult to move about freely for several weeks thereafter, owing to the increase of pain and a return of the swelling and at first to a recurrence of the muscular contractions. The nervous shock was great, and the patient did not fully recover from it for two months or more. The immediate shock and effect of the poison was so great that, although the sting was inflicted in shallow water only a few meters from shore, the patient was only able to reach shore with the aid of fellow-bathers and had to be carried from the shore on a stretcher. Such a sting if inflicted in deep water would be a very serious matter aside from its after effects because of the immediate danger of drowning.

The stings were treated locally at first with alcohol and vinegar and then with a dressing made of soda and olive oil. The natives suggested vinegar and sugar. Later, the affected parts were wrapped in cloths moistened with a 2 per cent aqueous solution of cocaine which, however, gave no perceptible relief.

The jellyfish which inflicted these stings belongs to the order Carybdeidæ, formerly called Cubomedusæ because of the squared or cubical shape of the bell; the species of this order are sometimes known as "sea wasps" because of their reputation as stingers. These jellyfish are very different from the more typical medusæ of the order Semaestomeæ of which the small white form with long oral palps and slender marginal tentacles, common in Manila Bay at certain seasons of the year, may be taken as an example. For reasons stated in a recent paper on Philippine Scyphomedusæ,² I consider this medusa to be the "*Chrysaora* stage" of *Dactylometra quinquecirrha* L. Agassiz.³ This is the common "sea nettle" of the Atlantic coast of the

² *This Journal*, Sec. D (1914), 9, 198.

³ Mayer, *Ibid.* (1910), 3, 585-588.

United States, which is able to inflict a very severe and in some cases dangerous sting.

The large white or white and purple form common in Manila Bay during the summer months is *Lobonema mayeri* Light, which may prove to be identical with *L. smithii* of Mayer. While able to inflict a very unpleasant sting, this medusa is not dangerous. This species and the common black medusa, *Catostylus purpurus* Mayer, which is harmless, belong to the order Rhizostomæ.

Dactylometra may be recognized by its long ribbonlike oral lappets and its numerous (24), slender, white, marginal tentacles. *Lobonema* may be recognized by its large size, by its long tapering tentaclelike marginal lappets, and by the long slender filaments which hang down in large numbers from the mouth arms.

In *Dactylometra* which the Filipinos call *fosforo* the sting is inflicted by nematocyst batteries in the 4 long ribbonlike oral palps, in *Lobonema* which the Filipinos call *lanterna* it is inflicted by the nematocysts of the long filaments which arise from the mouth arms, and this medusa may be handled with impunity if care is taken not to come in contact with these filaments, while in *Chiropsalmus* the nematocysts are located in the long marginal tentacles.

Chiropsalmus quadrigatus may be recognized by its deep transparent bell, about as high as thick and flattened laterally in 4 planes, and by its very long slender tentacles banded with lavender areas and arranged in 4 groups, typically 7 to a group, each group arising from a stiff hand-shaped projection of the exumbrella. The medusa reaches a diameter of 200 millimeters or more, with tentacles 1.5 meters in length. It is found in shallow water, and is especially dangerous as its transparency renders it very inconspicuous and it is apt not to be noticed by the bather.

The severe stings inflicted by this medusa are easily understood when the tentacles are studied under the microscope. The violet or lavender bands spoken of above are completely covered on their outer surface with thousands of closely approximated, slender, comparatively large, stinging thread cells or nematocysts. A nematocyst consists in general of a capsule, the outer end of which is extended to form a long hollow hair, which usually bears on its outer surface recurved hooks or spines. At rest, this hollow hair is introverted and lies coiled within the capsule.

There is usually a little trigger-shaped projection of the ectoderm cell in which the capsule lies. This projection is called the cnidocil, and when touched causes the discharge of the stinging hair which turns out on itself as when one blows out the in-turned finger of a glove. Piercing the skin while only partially everted, it continues the process within the tissues, at the same time discharging the poisonous fluid which it contains. Glaser and Sparrow⁴ found the discharge of nematocysts to be controlled by changes in osmotic pressure. While the amount of the fluid discharged from a single nematocyst is very slight, the nematocysts are so numerous in a small area that the aggregate amount of poison discharged into the tissue must be considerable. This fluid has never been analyzed from any of the dangerous medusæ, and it would seem that this form which is very common at a certain season of the year in many places in the Islands, particularly in Culion and in Subig Bay, would afford excellent opportunities for study along this line, because of its enormous numbers of localized nematocysts.

Specimens of this medusa were collected by the *Albatross* at several points in Luzon and at Masbate and Mindanao. While with the biological survey party, I found them to be plentiful on the Sulu Sea side of Palawan and at Culion and Busuanga. The species is apparently widely distributed in the Archipelago, and bathers should be on the lookout for it. The natives in Palawan report numerous severe stings, some of them, particularly in the case of children, resulting in death, and it was notable that after the appearance of the medusa in that region the children were almost never seen in the water.

Old⁵ of the United States Navy and formerly stationed at Cañacao, Cavite, has reported several cases of severe poisoning by Scyphomedusæ in two of which death occurred. The jellyfish responsible for these cases were probably *Dactylometra*, although Dr. H. M. Smith thinks they were due to *Lobonema smithii* Mayer.⁶ I have never seen *Lobonema smithii*, but I have seen numerous cases of stings by *Lobonema mayeri* which, as I have said, may prove to be identical with Mayer's *L. smithii*, the main differences being in the number of radial canals. Furthermore, I have experienced these stings myself, and while by no means pleasant they are not dangerous. *Catostylus purpurus* Mayer and *Aurellia labiata* Cham. and Eysen., the only other

⁴ *Journ. Exp. Zool.* (1909), 6, 361-382.

⁵ *This Journal, Sec. B* (1908), 3, 329.

⁶ Mayer, *Medusae of the World* (1910), 3, 690-691.

common medusæ in Manila Bay, are harmless, and I have handled them on numerous occasions without suffering any sting whatsoever. *Dactylometra* on the other hand is known to be very dangerous. Several cases of severe stings inflicted by it are known, and the natives, particularly the fishermen, hold it in great fear. While the symptoms reported by Old were quite different in many ways from the symptoms usually following the sting of *Dactylometra* and those in the case reported here, and while they may have been due to *Lobonema smithii* or some hitherto unreported medusa, it seems probable that they were merely the results of very severe poisoning from the sting of *Dactylometra*.

SOME SIMPLE LABORATORY APPARATUS

By R. B. GIBSON

(From the Department of Physiology, College of Medicine and Surgery,
University of the Philippines)

Three text figures

The results of the physiological experiments, as taught in the laboratory, are often lost to the student because the complexity of the apparatus distracts him from the actual observation. Moreover, the use of expensive physiological apparatus in many experiments necessitates either demonstration work or the employment of groups of students. I have found, particularly with Filipinos, that it is highly desirable from a pedagogic standpoint to simplify the experiments so that more of them may be performed and reported by each student individually.

In developing a course along these lines, three pieces of apparatus have already proved so useful that it has seemed worth while to describe them.

THE THERMOESTHESIOMETER

This thermoesthesiometer (fig. 1) is made by inserting a wire nail through a small cork which is then fitted into the constricted end of the glass chamber of the Porter muscle warmer or finger plethysmograph (supplied by the Harvard Apparatus Company). The other opening is provided with a suitable cork. A wire test-tube holder forms the handle.

For use, the glass chamber is filled with ice shavings or with hot water. A single charge of the ice or hot water is more than sufficient for locating the hot or cold points of the skin, when observed in the usual way.

A VENOUS-PRESSURE APPARATUS

The simple arrangement (fig. 2) may be used in place of the von Recklinghausen¹ and the Eyster and Hooker² apparatus for venous pressures in man.

A finger of a discarded rubber surgical glove is cut off and drawn over a small glass filter funnel. The tip of the finger is carefully trimmed away as in the illustration. The funnel is

¹ *Arch. f. Exp. Path. u. Pharm.* (1906), 55, 470.

² *Bull. Johns Hopkins Hosp.* (1908), 19, 274.

connected by tubing through a T to a manometer and a rubber bulb.

To make an observation, the skin over the selected vein of the forearm is swabbed with glycerol, the funnel is inverted upon this area and is held lightly in place. A slight positive pressure within the funnel seals the rubber flange against the skin and the funnel itself may be raised off the vein. The collapse of the vein may be observed through the glass sides of the funnel. Hinged blocks for the pressure bulb increase the accuracy of the results.

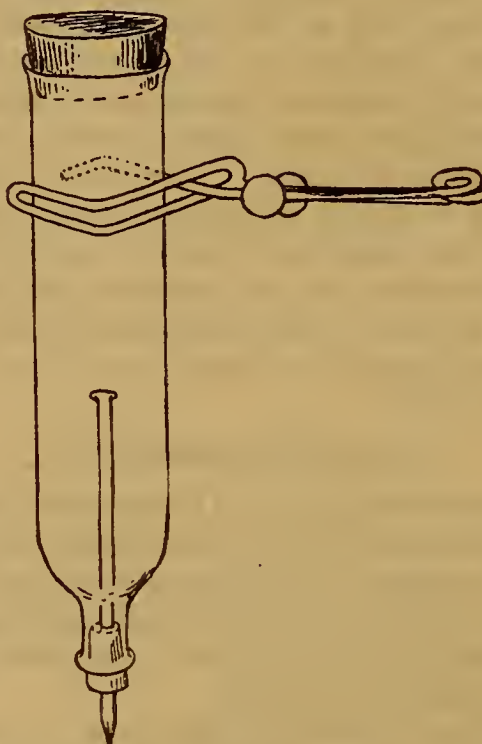

FIG. 1. The thermoesthesiometer.

A SIMPLE TIMING SYSTEM

While most laboratories are satisfactorily equipped with a time-marking system for class purposes, no very satisfactory instruments of this kind are commercially available. In many laboratories one finds timing systems which have been devised and made in the school itself. The excellent electric clock which is part of the equipment of the majority of American laboratories is too delicate an instrument for continuous use or for supplying a number of work tables.

The apparatus here described (fig. 3) can be set up with a few hours' work, and has given excellent service for twelve laboratory benches.

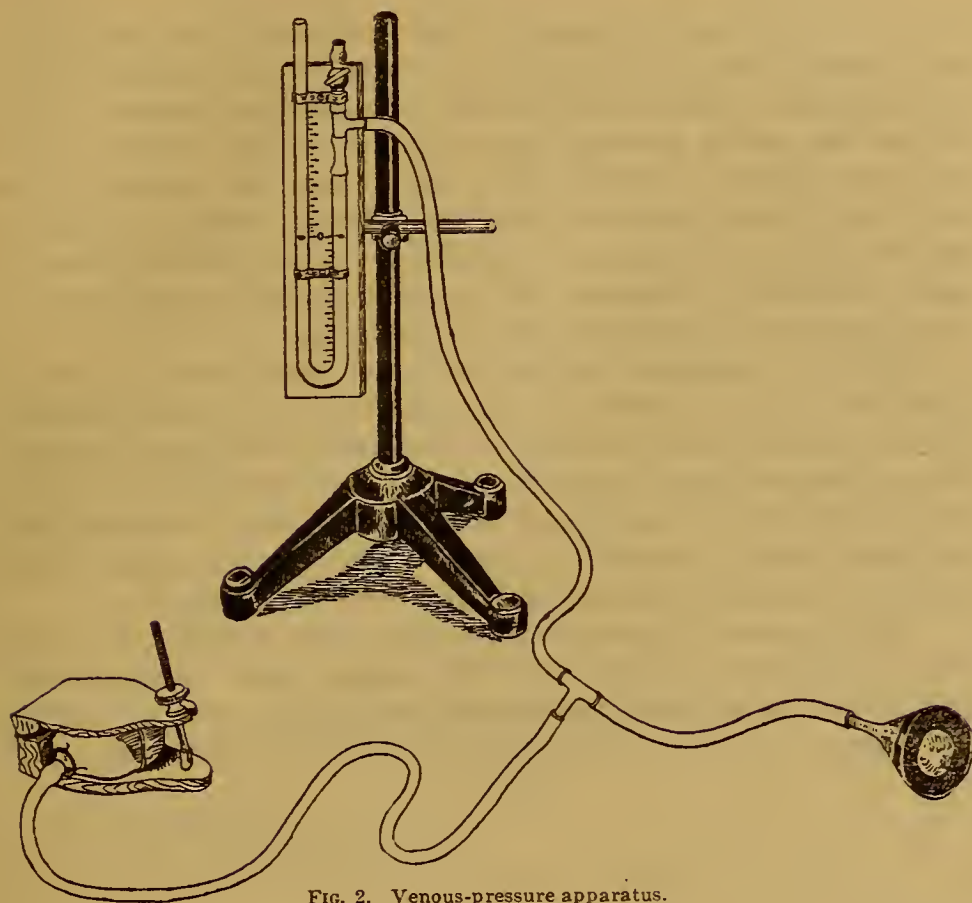

FIG. 2. Venous-pressure apparatus.

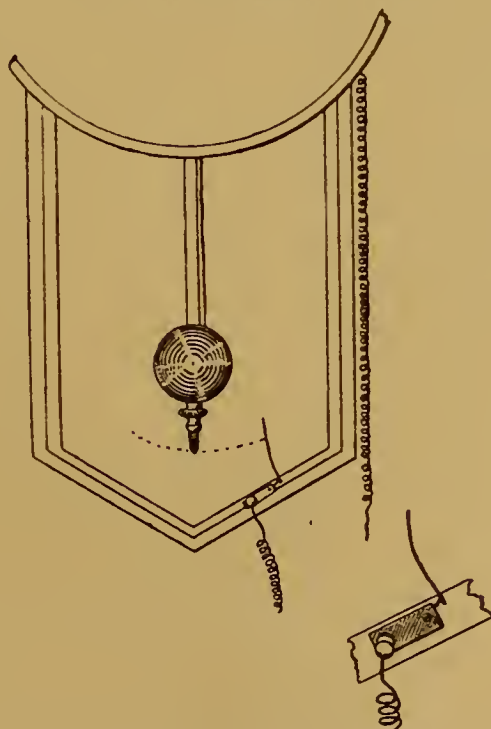

FIG. 3. Arrangement of wall clock for timing purposes.

A watch spring is inserted in the woodwork of an eight-day wall clock, with a pendulum of a half-second period. The arrangement is such that a contact is made each second at the end of the swing between the extremity of the pendulum rod and the spring. Parallel wires lead from the works of the clock and from the spring through binding posts in pairs on the several work benches. Six large dry cells furnish the necessary electricity to operate the signal magnets which may be connected to the binding posts on the tables.

With this apparatus, electricity is not being used up except when the circuit is closed by the insertion of a signal magnet. The timer is always ready when it is necessary to make a record. Two or twelve signal magnets may be used simultaneously, and may be inserted on any bench without reference to connections on other tables. The time in seconds will be represented on the record as a single vertical projection from the base line.

The apparatus requires no attention except winding the clock once every week. Occasionally the contact point on the pendulum should be polished with emery and a little mercury rubbed into the brass. The spring should be kept free from rust.

ILLUSTRATIONS

TEXT FIGURES

- FIG. 1. Thermoesthesiometer.
2. Venous-pressure apparatus.
3. Arrangement of wall clock for timing purposes.

REVIEWS .

The | Practice | of | Medicine | a text-book for practitioners and students | with special reference to diag- | nosis and treatment | by | James Tyson, M. D., LL. D. | [4 lines] | and Mr. Howard Fussell, M. D. | [4 lines] | Sixth edition, revised and rewritten | with six plates | and 179 other illustrations | Philadelphia | P. Blakiston's Son & Co. | 1012 Walnut Street | 1913.

The present revised edition of Tyson's Practice of Medicine is quite up-to-date and it contains many new subjects. The most important among these are: Diseases of the Pituitary Gland, Diverticulitis, Diseases of the Thymus Gland, Hypothyroidism and Hyperthyroidism, Osteopsathyrosis, Oxicephaly, and many others. It is, however, to be regretted that the so-called Tropical Diseases have not received the proper attention that they deserve in their revision. The description of some of them is very unsatisfactory and is not consistent with the modern views that we have of them at present. With this minor exception there is no doubt that this book on Practice of Medicine deserves to be highly recommended for its worth, and it will continue to be one of the favorite textbooks among medical students, on account of the preciseness and clearness with which it deals with the whole subject of internal medicine.

A. G. SISON.

Pathogenic | Micro-organisms | a text-book of | microbiology for physicians | and students of medicine | by | Ward J. MacNeal, Ph. D., M. D., | professor of pathology and bacteriology in the New York | post-graduate medical school and hospital, New York | (based upon Williams' Bacteriology) | with 213 illustrations | Philadelphia | P. Blakiston's Son & Co. | 1012 Walnut Street | 1914 | Cloth, pp. i-xxii+1-462. Price \$2.25.

This volume should more properly be termed a manual than a textbook, and like many of its class it attempts too much, rather than too little. In a hasty glance through the book the following criticisms may be mentioned. That portion of Chapter I dealing with the development and principles of the microscope might well have been omitted. In Chapter II under testing disinfectants no mention is made of the U. S. Hygienic Laboratory method: a very important omission in the opinion of the reviewer. The use of Dieudonné's medium is ignored under the bacteriological diagnosis of cholera. Quite a few typo-

graphical errors occur throughout the text, but the book on the whole will undoubtedly fill the purpose for which it was written.

J. A. JOHNSTON.

Man a Machine | by | Julien Offray de la Mettrie | French-English | including Frederick the Great's | "Eulogy" on la Mettrie and ex- | tracts from la Mettrie's "the | natural history of the soul" | philosophical and historical notes | by | Gertrude Carman Bussey | M. A., Wellesley College | Chicago | The Open Court Publishing Co. | 1912 | Cloth, pp. 1-216. Frontispiece.

The essays which outline La Mettrie's metaphysical doctrines are chiefly of historical interest. In his argument in favor of materialism, he draws on many experimental observations, some original, to develop the physiological analogy between man and the lower animals. In spite of the deficient physiological knowledge of the time (1748), La Mettrie's arguments are rational, and many parts of the essays read like mechanistic papers of the present day.

R. B. GIBSON.

Practical | Bacteriology, Blood Work | and | Animal Parasitology | including | bacteriological keys, zoological tables | and explanatory clinical notes | by | E. R. Stitt, A. B., Ph. G., M. D. | medical inspector, U. S. Navy; graduate, London school of tropical medicine; head | [etc. 6 lines] | Third edition, revised and enlarged | with 4 plates and 106 other illustrations containing 513 figures | Philadelphia | P. Blakiston's Son & Co. | 1012 Walnut Street | 1913 | Cloth, pp. i-xv+1-408. Price, \$1.50.

While the third edition of this manual is enlarged and brought up to date in a general way, the most notable changes from the second edition are found in the section on animal parasitology. Many of the illustrations in this section are new and they are excellent. This book could not replace the larger textbooks upon the various subjects with which it deals, but like the preceding editions it will doubtless be extremely useful not only to the busy practitioner but to the student as well.

DAVID G. WILLETS.

The American | Illustrated | Medical Dictionary | a new and complete dictionary of | the terms used in medicine, surgery, | dentistry, pharmacy, chemistry, nurs- | ing, veterinary science, biology, medi- | cal biography, etc., with the | pronunciation, derivation, and definition | including much collateral information | of an encyclopedic character | by W. A. Newman Dorland, A. M., M. D. | member of committee on nomenclature, [etc. 4 lines] | together with new and elaborate tables of arteries, muscles, [etc. 4 lines] | seventh edition, revised and enlarged | Philadelphia and London | W. B. Saunders Company | 1913 | Pp. 1107, flexible leather, \$4.50.

This new edition of "Dorland" is an excellent and convenient medical dictionary brought well up-to-date by the introduction of over 5,000 new terms, including advances in all branches of medicine.

B. C. C.

An Essay on | Hasheesh | including | observations and experiments | by | Victor Robinson | contributing editor, Medical Review of Reviews | [etc. 3 lines] | Medical Review of Reviews | Two hundred and six Broadway | New York | 1912 | Cloth, pp. 1-83. Price \$0.50.

Cardio-vascular Diseases | recent advances in their anatomy, physi- | ology, pathology, diagnosis and | treatment | by | Thomas E. Satterthwaite, A. B., M. D., LL. D., Sc. D. | Consulting Physician Post-Graduate, Manhattan State, Orthopedic, | Babies', Champlain Valley Hospitals and North Eastern Dispen- | sary; etc. [11 lines] | [motto] | Lemcke and Buechner | 32 West 27th Street New York City | no date. Copyrighted 1913. Cloth, pp. 1-166, 80 text figures.

PUBLICATIONS FOR SALE BY THE BUREAU OF SCIENCE,
MANILA, PHILIPPINE ISLANDS—Continued

BOTANY

A FLORA OF MANILA

By ELMER D. MERRILL

Order No. 419. Paper, 490 pages, \$2.50, postpaid.

Practically a complete flora of the cultivated areas in the Philippines. Descriptions, with keys, of over 1,000 species, 590 genera and 136 families, with native names, and necessary of technical terms, etc.

THE COCONUT PALM IN THE PHILIPPINE ISLANDS

Order No. 37. Paper, 149 pages, 30 plates, \$1, postpaid.

The reprint contains the following articles: On the Water Relations of the Coconut Palm (Cocos nucifera), The Coconut and its Relation to Coconut Oil, The Keeping Qualities of Coconut Oil and the Causes of its Rancidity, and The Principal Insects Attacking the Coconut Palm.

INDO-MALAYAN WOODS

By FRANK W. FOXWORTHY

Order No. 411. Paper 182 pages, 9 plates \$0.50, postpaid.

In Indo-Malayan Woods, Doctor Foxworthy has brought together a large amount of accurate information concerning trees and woody plants of economic value.

ZOOLOGY

A LIST OF THE MAMMALS OF THE PHILIPPINE ISLANDS, EXCLUSIVE OF THE CETACEA

By NED HALLISTER

Order No. 418. Paper, 64 pages, \$0.50, postpaid.

This is the only recent attempt to enumerate the mammals of the Philippine Islands. The distribution of each species is given and the original descriptions are cited.

ZOOLOGY—Continued

A MANUAL OF PHILIPPINE BIRDS

By RICHARD C. MCGREGOR

Order No. 103. Paper, 2 parts, 769 pages, \$4, postpaid.

A Manual of Philippine Birds contains in compact form descriptions of all the known species of Philippine birds. The usual keys and diagnoses of orders, families, and genera help the novice in identification.

A CHECK-LIST OF PHILIPPINE FISHES

By DAVID STARR JOHNSON and ROBERT EARL RICHARDSON

Order No. 102. Paper, 78 pages, \$0.75, postpaid.

This list will be found a convenient guide to the synonymy of Philippine ichthyology. The nomenclature is thoroughly revised, and the distribution of each species within the Philippine Islands is given.

MEDICINE

REPORT OF THE INTERNATIONAL PLAGUE CONFERENCE

Held at Mukden, April, 1911, under the auspices of the Chinese Government.

Edited by EDWIN MARTIN, G. F. PETERS, ARTHUR STANLEY, and ROBERT P. STERN

483 pages, 18 plates (2 colored, 4 half-tones, 12 charts and maps)

Order No. 416. Paper, \$2.50; cloth, \$3.50; postpaid.

The proceedings of this International Conference and information gained therefrom, together with the results of certain bacteriological investigations, constitute the present report.

The Bureau of Science of the Government of the Philippine Islands has been appointed sole agent for the distribution of the printed proceedings of the International Plague Conference.

PRICES ARE IN UNITED STATES CURRENCY

Orders for these publications may be sent to the BUSINESS MANAGER, PHILIPPINE JOURNAL OF SCIENCE, BUREAU OF SCIENCE, MANILA, P. I., or to any of the agents listed below. Please give order number.

The Macmillan Company, 64-66 Fifth Avenue, New York, U. S. A.
Wm. Wesley & Son, 28 Essex Street, Strand London, W. C., England.
Martinus Nijhoff, Lange Voorhout 9, The Hague, Holland.
Mayer & Müller, Prinz Louis Ferdinandstrasse 2, Berlin, N. W., Germany.
Kelly & Walsh, Ltd., 32 Raffles Place, Singapore, Straits Settlements.
A. M. & J. Ferguson, 19 Balliol Street, Colombo, Ceylon.
Thacker, Spink & Co., P. O. Box 54, Calcutta, India.

VOL. IX, PART B, NO. 1

AUGUST, 1914

THE PHILIPPINE JOURNAL OF SCIENCE

ALVIN J. COX, M. A., PH. D.
GENERAL EDITOR

SECTION B TROPICAL MEDICINE

EDITED WITH THE COOPERATION OF
W. L. WILSON, S. D. M., & DARRIN, PH. D.; A. D. WARD, D. V. M.
Committee on Departmental Medicine
V. O. DEIBER, M. D.; W. E. BURGHAVE, M. D.; S. C. CRUWELL, M. D.
Committee on Clinical Medicine
E. C. MORGAN, A. B.



MADE
BY THE
BUREAU OF PRINTING
1914

PUBLICATIONS FOR SALE BY THE BUREAU OF SCIENCE,
MANILA, PHILIPPINE ISLANDS

ETHNOLOGY

A VOCABULARY OF THE IGOROT LANGUAGE AS SPOKEN BY THE BONTOC IGOROTS

By WALTER CLAYTON CLAPP

Order No. 408. Paper, 89 pages, \$0.75, postpaid.

The vocabulary is given in Igorot-English and English-Igorot.

THE NABALOI DIALECT

By OTTO SCHMIDT

and

THE BATAKS OF PALAWAN

By DONALD Y. MOORE

Order No. 402. Paper, \$0.25; half morocco, \$0.75, postpaid.

The Nabaloi Dialect (65 pages, 29 plates) and the Bataks of Palawan (7 pages, 6 plates) are bound under one cover.

THE BATAN DIALECT AS A MEMBER OF THE PHILIPPINE GROUP OF LANGUAGES

By OTTO SCHMIDT

and

THE 'A' AND 'V' IN PHILIPPINE LANGUAGES

By CARLOS STANLEY COLETT

Order No. 407.

These two papers are bound under one cover, 18 pages, paper, \$0.50, postpaid.

THE IGBANUNS OF MINDANAO BAY

By LAWRENCE S. WALKER

Order No. 410. Paper, 121 pages, 1 plate, 29 plates, \$1.25, postpaid.

Mindanao Bay is situated on the north-west coast of Zamboanga Peninsula. The Igbanuns of this region were studied by Mr. Charles during two series of trips and six weeks, respectively.

The 29 plates illustrate the Igbanuns at work and at play, their industries, houses, attire, and implements; and the people themselves.

THE NEGROES OF SULU

By PAUL H. HENNING

Order No. 406. Paper, 75 pages, 4 plates, 4 diagrams, \$0.75, postpaid.

In the prosecution of his researches for the history of Sulu, Doctor Henning spent much time and effort in gathering access to documents in the possession of the Sultan of Sulu. This book is a history of the Negroes in the Philippines from the earliest times to the American occupation.

ETHNOLOGY—Continued

STUDIES IN MORO HISTORY, LAW, AND RELIGION

By NAJIB M. SALEEBY

Order No. 405. Paper, 107 pages, 16 plates, 5 diagrams, \$0.25; half morocco, \$0.75; postpaid.

This volume deals with the earliest written records of the Moros in Mindanao. The names of the rulers of Magindanao are recorded in five folding diagrams.

NEGRITOS OF ZAMBALES

By WILLIAM ALLAN RICE

Order No. 402. Paper, 83 pages, 62 plates, \$0.25; half morocco, \$0.75, postpaid.

Plates from photographs, many of which were taken for this publication, show ornaments, houses, men talking fire with bamboo, axes and arrows, drums, and various types of the people themselves.

INDUSTRIES

PHILIPPINE HATS

By C. H. REIDSON

Order No. 413. Paper, 66 pages, 8 plates, \$2.50 postpaid.

This paper is a concise record of the history and present condition of hat making in the following islands.

THE SUGAR INDUSTRY IN THE ISLAND OF NEGROS

By HERBERT S. WALKER

Order No. 412. Paper, 145 pages, 10 plates, 1 map, \$1.25, postpaid.

Considered from the viewpoint of practical utility, Mr. Walker's sugar industry in the island of Negros is one of the most important papers published by the Bureau of Science. This volume is a real contribution to the subject; it is not a mere compilation, for the author was in the field and understands the conditions of which he writes.

A MANUAL OF PHILIPPINE SILK CULTURE

By CHARLES S. GAWNE

Order No. 413. Paper, 31 pages, 20 plates, \$0.75, postpaid.

In A Manual of Philippine Silk Culture are presented the results of several years' actual work with silk-producing insects together with a description of the new Philippine race.

THE PHILIPPINE
JOURNAL OF SCIENCE
B. TROPICAL MEDICINE

VOL. IX

AUGUST, 1914

No. 4

THE PIPETTE METHOD IN THE ISOLATION OF SINGLE MICRO-
ORGANISMS AND IN THE INOCULATION OF SUBSTANCES
INTO LIVING CELLS

WITH A TECHNIQUE FOR DISSECTION, STAINING, AND OTHER PROCESSES
CARRIED OUT UNDER THE HIGHER POWERS OF THE MICROSCOPE ¹

By MARSHALL A. BARBER

(From the Biological Laboratory, Bureau of Science, Manila, P. I.)

Two plates and 19 text figures

CONTENTS

INTRODUCTION.	Preparation of organisms for iso- lation.
ISOLATION OF MICROORGANISMS.	Nutrient media.
General principle.	Illumination.
Method I.	Pipettes.
Apparatus.	Gas for the microburner.
Technique of isolation.	SPECIAL APPLICATIONS OF THE PI- PETTE METHOD.
Method II.	Isolation of organisms from quan- tities of water larger than hang- ing drops.
Method III.	Fixation and staining.
CULTIVATION OF THE ISOLATED OR- GANISM.	Serological tests.
Cultivation in situ on the cover glass.	Experiments on chemiotaxis.
Cultivation in a medium apart from the cover glass.	Dilutions.
Inoculation into animals.	Warm box.
DETAILED DESCRIPTION OF CERTAIN STEPS IN THE ISOLATION METH- ODS.	Dissection.
Moisture.	The pipette and isolating chamber used as separate units.
Danger of contamination.	Inoculation into living cells.

¹ Received for publication, December 12, 1913.

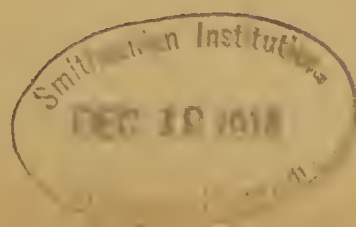

INTRODUCTION

Since the classical work of Hansen in isolating single cells of yeast plants, various methods of isolating single organisms under microscopical control have been described. In the method of Lindner, employed chiefly in the isolation of yeast cells or relatively larger organisms, droplets of a highly diluted culture are placed on a cover glass with a fine, sterile drawing pen. The preparation is placed over a moist chamber and examined for a droplet containing a single organism. In the well-known method of Burri,² a dilution of the organisms is made in India ink. With a sterile drawing pen, fine droplets are placed on solidified gelatin, and a cover glass is placed over them. The contrast between the organism and the dark background makes it possible to distinguish the organisms clearly and to find a droplet which contains but a single one. The organism is left to form a colony in situ, or the cover, with the organism clinging to it, is transferred to any desired medium. In the method of Schouten,³ the single organism is picked out from a dilution by means of a very fine glass loop in a moist chamber and under microscopic control.

The method described here is founded on a principle wholly different from any of those described above. No preliminary dilution of the microorganisms is necessary, except such as may be carried out under the microscope at the moment of isolation, and this dilution is required only in relatively dense suspensions. I first used the method in 1902 in connection with the selection of yeast plants. The description of the method was first published in 1904⁴ and more fully in 1907.⁵ It was, so far as my knowledge extends, the first method of isolating organisms under microscopic control described since that of Lindner. Since the first publications of the technique, various modifications and improvements have been described in later papers. The chief aim of this article is to bring together these various descriptions and to add considerable material not before published.

The method has been introduced into a number of laboratories, and it is hoped that this description may lead to its wider use. It is believed that the method has a universality of application which will make it of use not only to bacteriologists, but also to workers in all departments of microscopy. Single bacteria

² Das Tuscheverfahren. Jena. Gustav Fischer (1909).

³ *Zeitschr. f. wiss. Mikros.* (1905), 22, 10.

⁴ *Journ. Kans. Med. Soc.* (1904), November.

⁵ *Sci. Bull.*, Kansas Univ. (1907), 4, 3.

of any degree of motility or of any size visible under an ordinary oil-immersion lens, yeast cells, spores of fungi, algæ, protozoans, blood corpuscles, or other histological elements may be isolated. A cell may be selected from a pure culture or from a myriad of other organisms larger or smaller than itself. Organisms may be selected from cultures or from the natural sources, and the whole process may be carried out in any fluid desired. The isolated organism may be cultivated in situ, transferred to any medium, or inoculated into an animal. Microorganisms, stains, fixatives, or other chemical substances may be injected into the protoplasm or vacuoles of living cells. Microscopic plants, animals, or histological elements may be dissected or stained under the higher powers of the microscope.

The isolation of organisms and some of the other applications of the technique may be carried out with the aid of only the ordinary apparatus of a biological laboratory.

Since the earlier publications, I have had much experience in teaching the method to others. The difficulties of the technique are certainly not insurmountable, since several learners have, under my direction, succeeded in making pipettes and isolating organisms after less than an hour's practice. The results of this experience in teaching have shown me some of the chief difficulties of the beginner, and it is hoped that the following description will make the technique easy to acquire without the assistance of personal supervision.

In some cases details have been given which may seem superfluous to many workers, but it was thought better to err on the side of over description than to risk leaving any point obscure.

The method of isolation of microorganisms described here is, of course, not recommended as an entire substitute for plate methods in any routine work. In some cases the pipette method may be conveniently used as such, but the chief aim of this technique is to amplify the plate method and to carry out some isolations where the plate method is not applicable.

ISOLATION OF MICROÖRGANISMS

GENERAL PRINCIPLE

The principle of the method, in brief, consists in the separation of the single organism by means of a very fine-pointed, capillary pipette of glass. The isolation is carried out in hanging drops on the underside of a large cover glass which is placed over a moist chamber. The organism to be isolated is touched with

the tip of the pipette, into which it enters by capillarity. A sterile portion of the cover is brought over the tip, and the organism is discharged on it by air pressure through a rubber tube held in the mouth of the operator. The whole process is carried out under the microscope, under the highest powers if desired.

The pipette is the most essential part of the apparatus, and the governing of its movements is a vital part of the technique. There are several ways of holding and manipulating the pipette, and for the sake of convenience each will be described as a separate method.

METHOD I

In this method the pipette is manipulated by means of a special holder clamped directly to the stage of the microscope or to a metal plate fastened to the underside of the stage.

APPARATUS

The apparatus needed are the following:

1. A compound microscope furnished with a mechanical stage, preferably one allowing wide movement in both directions.
2. The pipette holder, preferably the type with three movements.⁶
3. A specially constructed moist chamber.
4. Large cover glasses to fit the top of the chamber.
5. A piece of rubber tubing about 70 centimeters long and about 6 millimeters in diameter.
6. Pieces of glass tubing, 15 to 20 centimeters in length, about 4 to 5 millimeters in diameter, and with a lumen about 3 millimeters in diameter.
7. A microburner with a very small flame.

Some parts of the above apparatus are here described in detail:

There are two types of pipette holder: the one having movements, accurately governed by screws, in three directions of space; the other having but two such movements mechanically governed, the movements to the right or left of the observer being accomplished by sliding the pipette in a groove with the fingers. The three-movement holder is preferable, as the additional movement makes the technique easier for the learner, saves time in adjusting the pipette, and enables the worker to

⁶ Pipette holders may be obtained from the University of Kansas, Lawrence, Kansas, U. S. A.

carry out more successfully certain special applications of the technique to be described below.

The three-movement pipette holder containing a pipette and clamped in position on the microscope is illustrated in figs. 1, 2, and 15, showing the front, that is, the side facing the observer, the top, and the back, respectively.

The adjustment *ud*, governed by the screw *s*, allows an up-and-down movement. The adjustment *rl*, governed by the screw *s'*, allows a movement to the right or left, and the adjustment *tf* and the screw *s''* (fig. 15) allow a movement to and from the observer. The to-and-from movement carries the two other adjustments with it, and the up-and-down adjustment carries the in-and-out. The holder is fastened by the clamp *cl* to the metal plate *pa* or *pb*, which is screwed to the stage of the microscope. The pipette is held in the groove *g* (fig. 2) in the side of the adjustment *rl*, and is fixed by the set screw *ss*, which moves the thin plate *tp*. A two-movement holder is shown in fig. 9 and in fig. 15, *B*.

The small tightening screws on the holder should be so adjusted that the up-and-down movement can be easily manipulated with one finger only. This will allow a rapid lowering of the pipette.

The holder may be clamped directly on the stage of the microscope, but in most types of microscope the pipette is brought to a more convenient level and more working room allowed if a metal plate (see *pb*, *p*, and *pa*, figs. 1, 13, and 15) is screwed on the bottom of the stage of the microscope. This may be attached with thumb screws, so that it can be easily taken off or put on. A convenient form is shown in *p*, fig. 13. This type allows the holder to be set at either of two different levels and at two different distances from the stage. In some processes it is necessary to move the mechanical stage far to the left. In this position the isolating chamber is apt to interfere with the pipette holder, so it is well to have some arrangement for clamping the holder 1 or 2 centimeters from the stage. Either type *p* or type *pa*, fig. 13, will permit this movement. Type *pa* may be attached when two holders are to be used or when certain special processes are to be carried out. Another form of plate is shown in *pb* (fig. 1).

As a temporary expedient, the pipette holder may be attached to a flat piece of wood placed under the stage. The wood is shaped like the stage, perforated with an opening for the condenser, and provided with a shelf on the left for attaching the

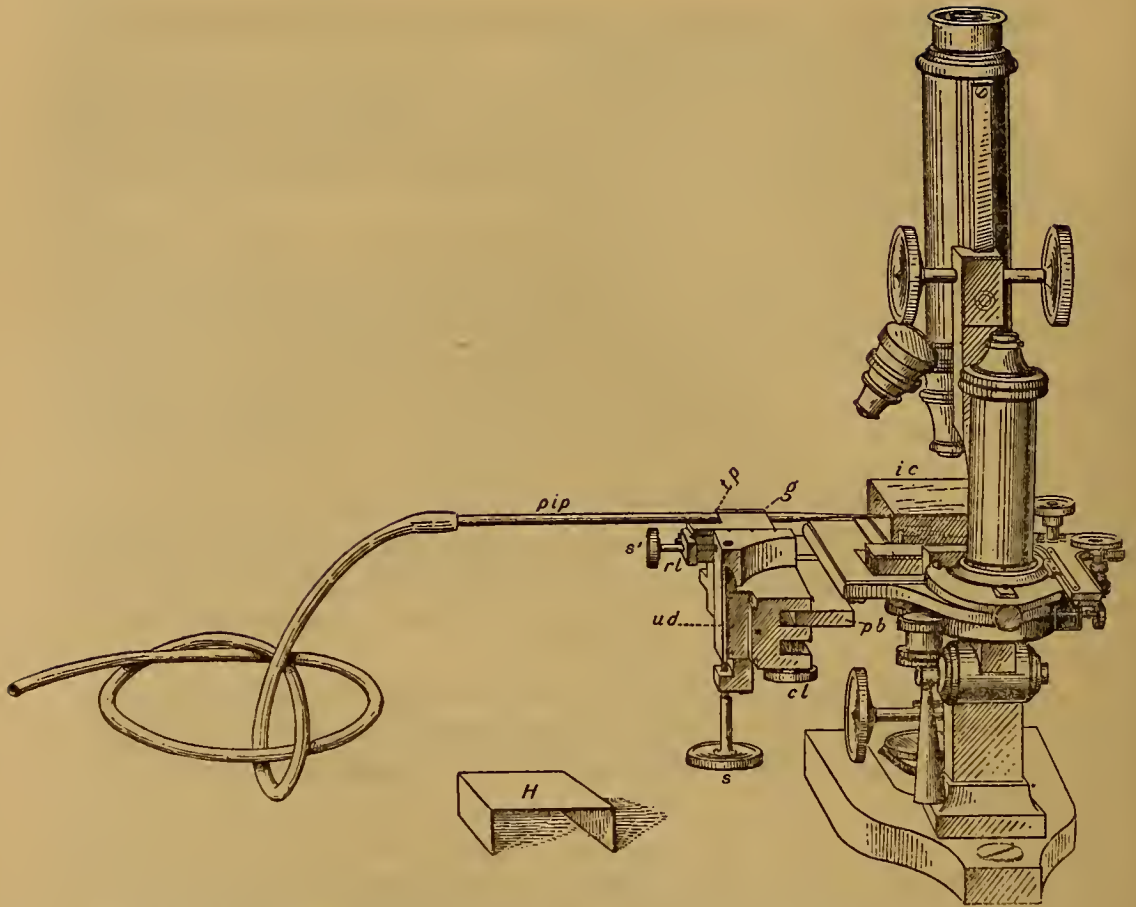

FIG. 1. Pipette holder containing a pipette (*pip*). *cl*, clamp by which the holder is fastened to the metal plate *pb*; *ud*, up-and-down adjustment governed by screw *s*; *rl*, right-and-left adjustment governed by screw *s'*; *g*, groove in which the pipette is held by the plate *tp*; *ic*, isolating chamber; *H*, hood of pasteboard for protecting the end of the isolation chamber.

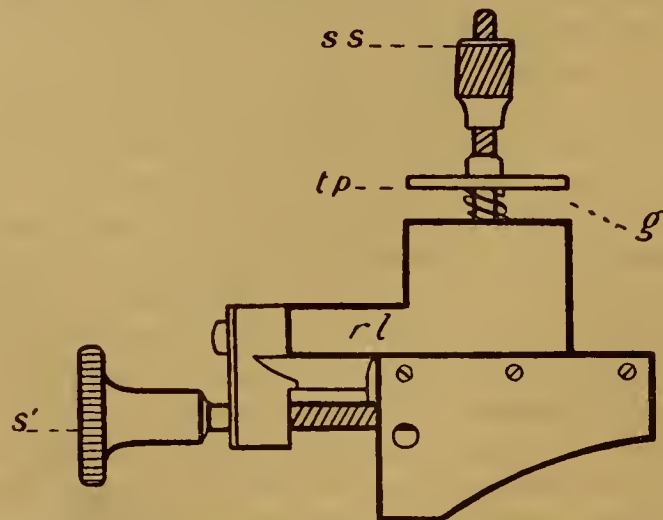

FIG. 2. Top of pipette holder. *rl*, right-and-left adjustment governed by screw *s'*; *g*, groove in which the pipette is held by plate *tp* and set screw *ss*.

pipette holder. It may be fastened to the stage by means of small clamps.

The moist chamber (fig. 3) is made by fastening strips of glass to a slide with Canada balsam or any convenient cement. It is well to cement an additional strip on the slide at the open end *s*. This serves to hold water in the bottom of the chamber and to strengthen the whole apparatus. Pieces of slides may be used in making the chamber, but it is better to have glass of somewhat greater thickness—about 1.5 millimeters. A very convenient size for the moist chamber is 70 millimeters long, 35 wide, and 28 high. If the mechanical stage in use will not admit so broad a chamber, one of the width of an ordinary slide may be used. The narrow chamber is more readily kept moist, the narrower cover glass suited to it is more easily cleaned, and the preparations grown on this cover glass are more easily stained and mounted than is the case with the larger cover glass. However, the broader chamber gives much more working room, and for most routine work will be found more convenient. It is advisable to make two or three moist chambers at a time. One narrow and two broad ones will give a good working outfit. Temporary isolation chambers may be made of wood or strong pasteboard. A convenient way is to modify a wood or pasteboard box, cement it to a slide, and make it partially waterproof at the bottom with Canada balsam or any convenient substance.

The height recommended is chosen because it gives working room for the pipette without being so far from the stage as seriously to diminish the light. It will be found very advantageous to replace the ordinary substage condenser with one which will focus the light at a point somewhat above the stage. This is especially adapted for work with the oil-immersion lens or other high powers. The moist chamber is lined on the sides and end with filter paper, *p* (fig. 3), in order to furnish a larger moist surface. The upper edges of the isolating chamber should be even and smooth, so that the cover glass may be easily sealed on them.

The cover glass should be large enough to seal well to the sides of the chamber and to reach to the ends. It should be of such thickness as to permit safe handling, while not so thick

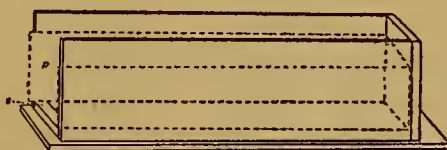

FIG. 3. Isolating chamber. *p*, lining of blotting paper; *s*, glass strip for retaining water in bottom.

as to prevent the use of the immersion lens. Thickness 2, as quoted in American catalogues, suits the purpose well.

The preparation of the cover glass is a matter of great importance to the success of the technique. One should clean the cover carefully and then apply just enough vaseline or fat to prevent the small hanging drops from running together. A good method is to smear vaseline over a number of well-cleaned covers and to place them in some convenient receptacle free from dust. When the covers are to be used, they are freed from the excess of vaseline by means of soap and water, cleaned carefully with a dry cloth, then heated enough to soften the vaseline, and rubbed again while still warm. They may then be slightly moistened by the breath and rubbed again with a fresh clean cloth. The aim is to remove as much vaseline as possible without the use of excessive heat or any fat-dissolving reagents other than soap. If an excess of vaseline is left on the cover, small particles will appear in the droplets and may be mistaken for bacteria. If all is removed, the droplets will run together. Fine droplets placed very closely together will remain separate for months on a properly prepared cover. For the beginner, especially, success or failure may depend on the condition of the cover glass. Cover glasses may be prepared and kept in stock for use, but it is well to rub them afresh with a clean, dry cloth just before sterilizing.

As to the glass tubing, the size recommended above is the best, but considerable latitude is allowable. Soft glass is, on the whole, preferable, as it is more easily worked. The fine tip at the end of the capillary is more easily made with hard glass, but the preliminary drawing out of the capillary often requires a blast flame, which is not always convenient to the working table.

To make a serviceable microburner, one has only to bend a glass tube to the form shown in fig. 5, *b*, to heat one end, and flatten it so as to form a narrow aperture. In the form shown in the illustration, a clamp is fastened to the back of a wooden block for convenience in adjusting the flow of gas. This block may be dispensed with and the tube kept upright by the clamp alone. The tip of the burner should be at a height of about 6 centimeters above the surface of the table.

TECHNIQUE OF ISOLATION

It is recommended that the beginner in this technique follow strictly the directions given below and in the order given:

1. Clamp the pipette holder firmly to the left side of the

stage in such a position that the groove *g* (fig. 1) will be nearly opposite the center of the condenser.

2. Smear the upper edges of the moist chamber thickly with vaseline, and add enough water to cover the bottom and to saturate the filter-paper lining. If the moist chamber has been exposed to dust, it is well to flame it lightly before adding the vaseline or water.

3. Sterilize the cover glass, prepared as described above, over a diffused heat. The flame of a gas stove or the top of the chimney of a Welsbach light gives a suitable heat. Avoid heating so much as to burn off the vaseline film.

4. Place the cover on the moist chamber, and press it down so as to seal it at the edges. Mark the upper surface as shown in fig. 4, using India ink or a glass pencil.⁷

5. With a platinum loop or, better, with a pipette bent at the tip, place drops of sterile broth on the underside of the cover, of somewhat the size and arrangement shown in fig. 4. The bacteria may be placed in drop *a*. This end of the cover is placed next to the open end of the chamber.

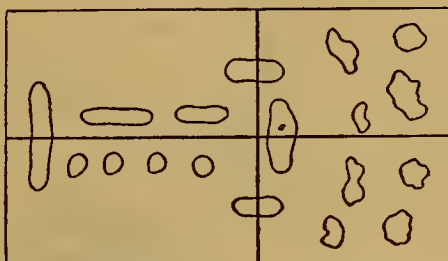

FIG. 4. Cover glass marked with cross lines of India ink, and supplied with hanging drops of sterile fluid. *a*, drop to which the bacteria to be isolated are added.

6. Place the chamber on the stage of the microscope, and focus with the low power on the center of the free edge of the cover. The edge should be approximately at the center of the field. Lower the objective within 2 or 3 millimeters of the cover glass. It is well to protect the open end of the moist chamber temporarily with a piece of moistened filter paper.

7. Make the capillary pipette as follows:

(a) Lower the flame of the microburner to a narrow blue flame not over 2 millimeters high. The smallest flame that will remain lighted should be used, and the working table should be free from drafts of air.

(b) In an ordinary Bunsen flame draw out one end of a piece of glass tubing into a straight capillary about 0.5 millimeter in outside diameter.

⁷ Fine straight lines may be made by dipping a fine capillary tube or rod into India ink or asphalt cement spread on a glass slide. The smeared capillary is laid on top of the cover in the position desired, and is then removed. India-ink lines have the advantage of being insoluble in immersion oil.

(c) Hold the shank of the pipette in the right hand, and with a pair of fine forceps held in the left grasp the capillary at a point about 6 centimeters from the shank. The outer sides of both hands should rest on the table. Bring the portion of the capillary next to the forceps over the flame and at right angles to it, then lower it to a point above, not in, the flame (fig. 5).

(d) Pull gently with the forceps, and when the glass begins to soften lift it slowly from the flame and pull with the forceps slightly more than at first, but not too strongly. The hands should remain on the table during the process and the pulling

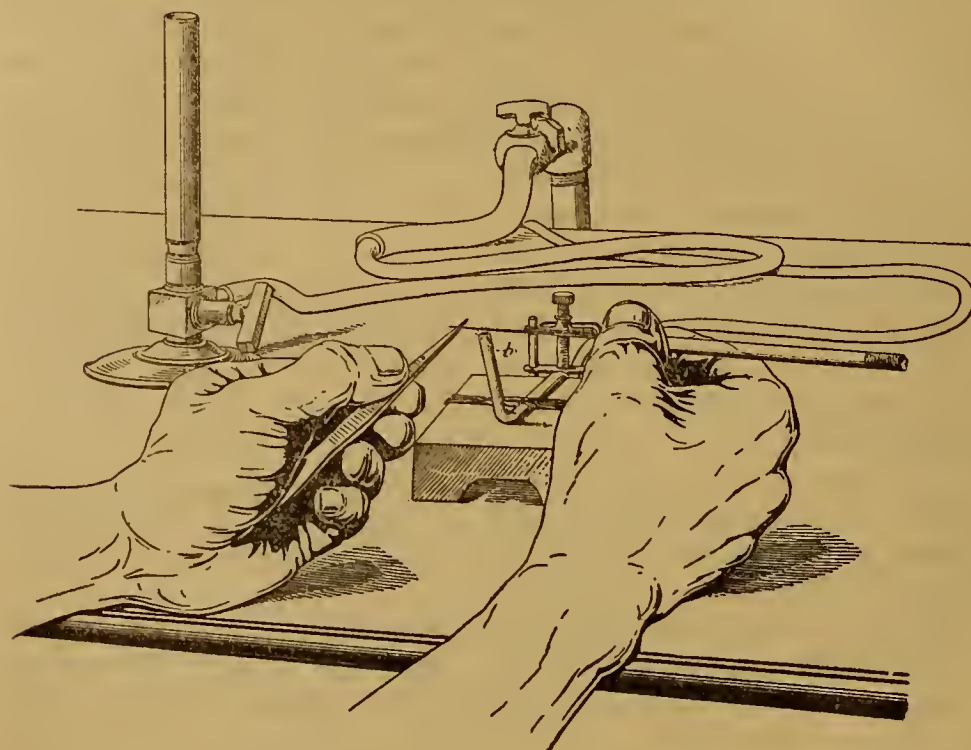

FIG. 5. Method of making the capillary pipette. *b*, microburner.

and lifting done by turning them slightly outward. The capillary will separate with a slight tug—a feeling much like that experienced when a taut thread, held in the fingers, is parted in a small flame. If the point is properly made, it will appear as shown in *b* (fig. 6).

This capillary has sufficient rigidity, and it comes to a very fine point. The tip is closed, but the lumen extends to the very end.

It is evident that everything depends upon the amount of heat used and the timing of the pull and that these must vary slightly with the height of the flame and the diameter of the

capillary. With a little experience, one can usually tell when a proper point is made by the peculiar feeling described above, but, if desired, the point may be inspected under the low power of the microscope or with a good hand lens. If too little heat is used and the pull made too suddenly, the capillary may part with a snap and the tip may have an opening too large for use. However, if a capillary parts with a snap and is seen to end in a very fine point, it is well to turn up the tip (see paragraph *e*) and place the pipette in the holder for inspection under the microscope. Sometimes excellent pipettes, with a small polished opening, are obtained when the glass, in a half-molten condition, parts with a gentle snap, *c* (fig. 6).



FIG. 6. *a*, Completed pipette; *b*, *c*, and *d*, various sorts of points.

If too much heat is used, the capillary is apt to be drawn into a long, hair-like ending, *d* (fig. 6). This is especially apt to be the case when the capillary is pulled with the right hand instead of with the forceps. Such points may be made serviceable by clipping off the end with sterile scissors or forceps or by placing the end on a slide and cutting off a portion with a scalpel. For the best work, however, the form *b* (fig. 6) will be found preferable to the others.

If the learner has continued difficulty in obtaining a suitable point, it is well to try hard glass. The capillaries are drawn out in the blast flame, and may be made of slightly varying diameters. The flame of the microburner should be slightly higher than for soft glass. A number of capillaries may be

prepared, sealed at the tips, and kept on the laboratory table ready for use.

(e) After a suitable point is made, the end of the capillary is turned up at right angles, as shown in *a* (fig. 6). This is done by holding the part of the capillary just back of the point above the small flame and lifting the point with the tip of the forceps or with a needle. Care must be taken to avoid fusing the glass and thus closing the lumen of the capillary. Not more than 1 centimeter should be turned, as a greater length will be found awkward to manipulate in the moist chamber. If a good point is made, it is not necessary to turn the end at exactly right angles.

8. After the pipette is finished, attach the rubber tube firmly to the end of the shank and set the pipette in the groove of the holder. Slip the pipette inward, pushing it with the left hand and governing the set screw with the right, until the tip is nearly under the low power of the microscope and is turned in a vertical position. It should be far enough beneath the cover glass to avoid danger of contamination. Set the screw so as to hold the pipette firmly. The exact adjustment of the tip under the center of the low power is attained as follows: Sight along the edge of the cover glass and move the right-and-left adjustment of the holder until the tip is in line with the edge. Then, looking in a direction at right angles to the first, bring the tip to the center of the lens by moving the to-and-from adjustment of the holder. Or one may make the second adjustment by sighting down the side of the tube of the microscope. If the tip is not now in view, it can quickly be found by moving some one of the adjustments of the holder. Focus the low power on the tip, and adjust it to the very center of the field. If desired, the pipette may be adjusted under the low power before the isolation chamber is placed on the stage. The mechanical stage is then moved as far as possible to the right and the chamber put in. One may also remove the eyepiece, turn the objective aside or remove it altogether, and adjust the tip below the empty tube. If it is adjusted to the center of the field, it will be in view on replacing the eyepiece and objective. The first described method will generally be found preferable.

9. Lower the tip safely below the level of the hanging drops, focus on the under surface of the cover, and with the mechanical stage bring the edge of one of the drops of sterile broth into the field. Lower the objective until the tip is in view, then slowly raise the objective and tip together until the tip comes

into contact with the cover just outside of the drop. These precautions are taken to avoid crushing the tip against the cover glass.

Sometimes it may be difficult to see the tip at any distance under the cover glass on account of the refraction of light due to the hanging drops. In this case, focus the low power 2 or 3 millimeters below the cover and bring the point up very slowly. It will usually come into view when it approaches the cover, especially if it is first brought up in a deep hanging drop. With the tip held gently against the cover, move the mechanical stage slightly and break off a very small portion of the point. Immerse the tip in the droplet of broth for a few seconds in order that it may become supplied with liquid. This process may be hastened by suction on the rubber tube, which during this part of the process is held in the mouth of the operator.

If the fields of the high and low powers of the microscope coincide, the tip should now be brought to the very center of the low-power field; if not, it should be brought to a point, previously determined, which is near the center of the high-power field. It is often helpful to use the micrometer eyepiece in locating this point, especially in changing from the low-power to the oil-immersion lens. Now bring the tip into contact with the cover glass near the edge of the broth drop, and blow out a very small drop with the rubber tube; then, before the liquid reenters by capillarity, lower the point slightly. If no drop can be blown out, immerse the tip in the broth again and draw in more fluid. If a very small opening is left, it may be necessary to enlarge it somewhat and refill from the sterile drop before it is possible to discharge a droplet. The cover glass should have a film of moisture on it so that the liquid in the pipette will be in contact with liquid on the cover. It is very difficult to discharge liquid from a fine point to a dry cover. If necessary, the film of moisture on the cover can be supplied by placing a little slightly warmed water in the bottom of the isolating chamber. A little distilled water may be taken into a medicine dropper, heated slightly over the flame, and added gently to the liquid in the bottom of the chamber. The moist air, rising, forms a film on the cover (Plate I, fig. 1).

With the tip just under the broth droplet, change to the high power. The droplet should be in the field, and when the tip is raised it will come into view. It may now be easily adjusted to the center of the high-power field. It is obvious that care must be taken not to move the mechanical stage or the cover glass during the change to the high power.

If the tip is already perforated, one has only to fill the pipette with a small quantity of broth, blow out a droplet, and, with this as a guide, find the tip with the high power. The advantage of the closed point is that it allows one to gauge the size of the opening to suit the organism to be isolated. The breaking off of the point can be more accurately done under the high power, and one can easily find the unbroken point by immersing it in the broth drop near its edge, and with the edge as a guide locate it under the high power. For one unaccustomed to the technique, however, the first-described method of breaking with the low power and making a broth droplet may be found easier; the tip can usually be safely broken off under the low power.

For ordinary isolation of bacteria, considerable variation in the size of the opening is allowable—about 2 to 5 microns will be found suitable for *Bacterium coli*, for example. If too large, say over 15 microns, the difficulty of isolation will be much greater. If too small, it will be found difficult to blow out the broth or to introduce larger bacteria. If the tip has a sealed blunt point, it is sometimes very difficult to break it open; it is usually best to make a new one at once.

10. After the tip is located at the center of the high-power field, lower it safely below the level of any hanging drop and bring the hanging drop containing the bacteria into the center of the field, preferably at its edge. If a particular bacterium is to be isolated, bring it to the center of the field and cautiously raise the tip of the pipette until it is just below the surface of the liquid. The tip may be seen as a shadow immediately below the drop. Now, moving the finger along the up-and-down adjustment of the holder, bring the tip into the drop near the bacterium, then lower it instantly. The bacterium usually enters the pipette by capillarity. Then move the hanging drop out of the field and raise the pipette into contact with a sterile part of the cover glass covered with fine droplets of condensed moisture. Blow out a very small drop. If the bacterium does not appear, move the stage slightly and blow out a second or, if necessary, a third or fourth drop. The droplets should be very small, and should be made near the edge of a hanging drop on one of the lines on the cover glass so that they may be easily located. If the bacterium sought comes out with one or more bacteria, move a field or so away, discharge liquid from the pipette until it comes out free from bacteria, return to the droplet, and if necessary dilute with a small quantity of broth. By repeating the selection from the diluted droplet, one can usually isolate the bacterium at once.

If there is difficulty in making a small drop, it is usually because the cover is too dry or the pipette opening too large, especially if large with very irregular edges. It is often possible to gauge the size of the droplets by raising the pipette up and down with a slight stippling movement, at the same time blowing gently into the rubber tube. Liquid will come out more easily if the tip is brought into contact with one of the larger drops of condensed moisture. This is usually unnecessary, unless the opening in the tip has a margin so even that it becomes closed on contact with the cover glass.

If no particular individual bacterium is wanted, a simple way to isolate one organism is to take up some dozens of them, eject them on the cover, and add broth from the pipette. Then fill the pipette with this dilution and make a series of fine drops, in one or several of which a single cell will appear. Where the original mixture is not too thick, it is often easy to take any isolated organism alone into a fine pipette. If several enter, it is a small disadvantage, since they may be separated immediately.

The droplet is made small so that one can easily assure himself that it contains but one organism. There is no danger of error if the droplet measures 25 microns or less in diameter. In such a droplet, for example, in peptone solution or any clear fluid, one can make sure of the presence of but one actively motile cholera vibrio. There is no need for India ink or any addition to the fluid to make the bacterium more conspicuous. With many organisms, much larger droplets will meet the requirements (Plate I, figs. 1 and 2). If necessary, one may introduce the pipette cautiously to the edge of the droplet and remove the liquid, leaving the organism against the cover where it becomes more conspicuous. The isolation may be done with the low power and the droplets examined with the higher powers afterwards, or the whole process may be carried out under a high power, the oil-immersion lens if desired. For the isolation of bacteria of ordinary size, a $\frac{1}{6}$ -inch objective will suffice.

If drops of moisture so large as to interfere with the making of the fine droplets have collected on the cover glass, a suitable area with fine droplets can almost always be found in the neighborhood of a larger drop of agar or broth. If a particle of doubtful nature is seen with the isolated bacterium in the droplet, it is usually easy to pick up either it or the bacterium and place each in a separate droplet. One may easily pick up the isolated bacterium and transport it to another part of the cover glass.

The isolation of bacteria can be done very quickly by one experienced in the technique. I have performed the whole pro-

cess, including the drawing out of the capillary and the making of the point, the adjustment under the high power, and the isolation of a micrococcus, in less than three minutes.

Recapitulation of the various steps in the isolation of bacterium by method I:

1. Clamp the pipette holder in position on the microscope.
2. Prepare the moist chamber.
3. Prepare and sterilize the cover glass.
4. Seal the cover glass to the moist chamber and mark its upper surface.
5. Place under the cover glass hanging drops of sterile nutrient fluid, and supply one of them with the bacteria to be isolated.
6. Place the moist chamber on the stage of the microscope, and focus on its free edge with the low power.
7. Make the capillary pipette.
8. Attach the rubber tube to the pipette, and adjust the pipette in the holder with its tip in focus under the low power.
9. Supply the pipette with sterile nutrient fluid from a hanging drop, and adjust it in the center of the high-power field.
10. Take up the bacteria and isolate them in separate droplets.

METHOD II

Some investigators may wish to obtain one-cell cultures of bacteria, fungi, algæ, or microscopical animals without having occasion to do more extended selections. Such persons may hesitate to go to the delay and expense of obtaining a pipette holder. The following method will enable the worker to obtain pure cultures with the assistance of only such apparatus and materials as are found in every laboratory. The technique is but slightly more difficult, and very precise results may be obtained. The preparation and setting up of the apparatus needed may be done in one or two hours, and the technique may be mastered by an ordinarily skillful laboratory worker in half a day or less.

The moist chamber, cover glasses, and tubing are the same as those used in the first method. In place of the pipette holder, an ordinary dissection microscope, supplied with ratchet and pinion, is firmly clamped to the table as far from the edge as the clamp will allow (fig. 7). The arm of the lens holder is turned backward, and on it a rectangular perforated cork is firmly fastened with a clamp or rubber bands. The opening in the cork should be large enough to hold the glass tubing snugly, but not so firmly as to prevent the slipping of the tube back and forth. The capillary and tip are made as in the first method,

and the blunt end of the tube is slipped through the cork. If the tube is too small to fit well, a piece of paper may be rolled around it. The rubber tube is now adjusted and passed under a clip of the stage of the dissecting microscope, so that any slight movement of the tube will not disturb the pipette.

The low power of the microscope is now focused on the free edge of the cover, then lowered somewhat as in the first method.

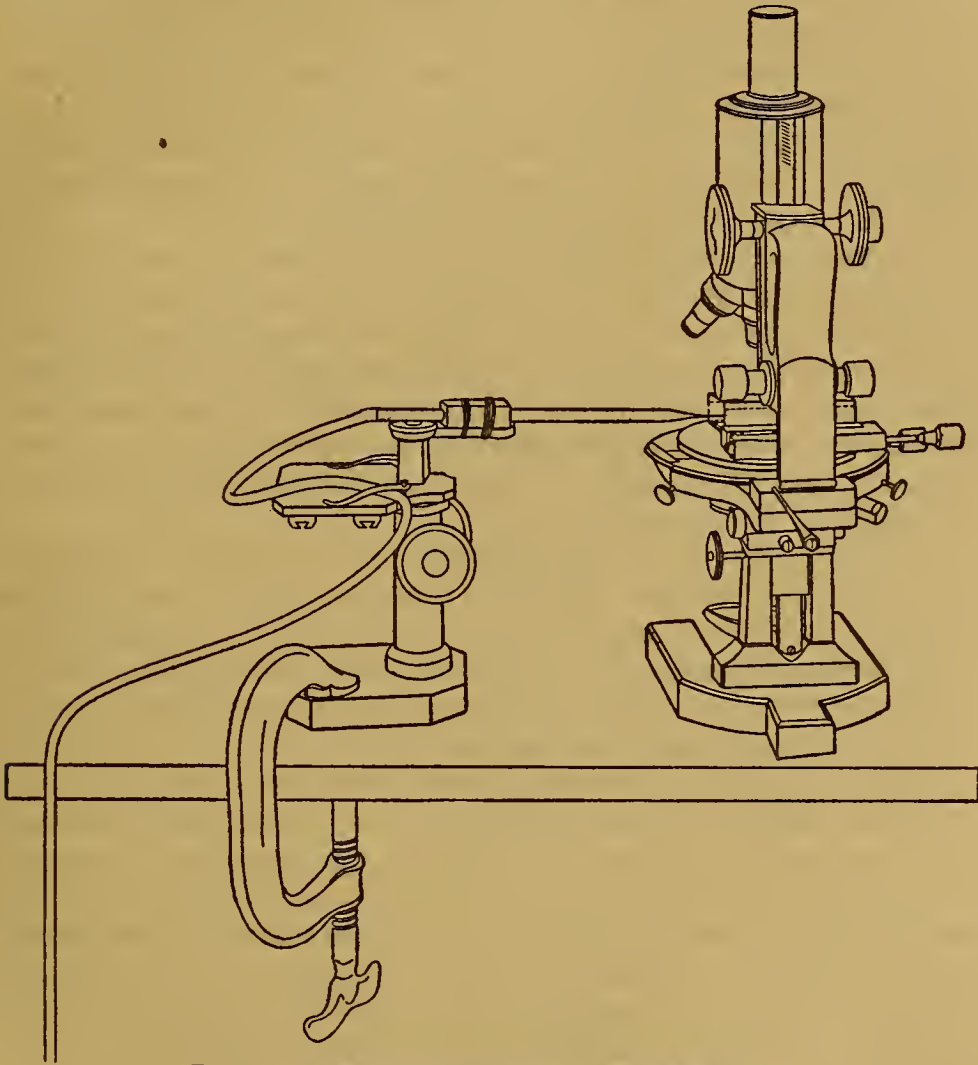

FIG. 7. A dissecting microscope used as a pipette holder.

The compound microscope is slipped along the table until the center of the free edge of the moist chamber is near the tip of the pipette; then the pipette is raised or lowered until it is about midway in the center of the opening. By sighting along the edge of the cover and adjusting the movable arm of the simple microscope, one can bring the tip of the pipette into such a position that it can be found with the low power. In case it is not

readily found in this way, the pipette may be slipped in and out or moved back and forth until the tip comes into view. It is important to have the tip at a safe distance from the cover, because it is more liable to be broken with these less exact adjustments than is the case when the pipette holder is used.

The tip may now be brought to the center of the field or to a point which corresponds with the center of the high-power field. The finer in-and-out adjustment may be made by slipping the tube with the fingers held in contact with the glass and with the top of the pillar of the dissecting microscope. The fine adjustment to and from the observer may be done accurately by suspending a pencil pendulum-wise from the fingers and very gently tapping the end of the arm of the dissecting microscope on the one side or the other, as the case may require.

The high power is adjusted as in the first method, and further adjustments to the center of the field are made by tapping the arm of the holder for one direction and moving the nose piece of the microscope for the other. Considerable right-and-left adjustment may be obtained by the nose piece alone without materially interfering with the illumination or definition. In some microscopes it may be necessary to loosen, temporarily, the clip fixing the position of the nose piece.

The better the focusing apparatus of the simple microscope, the better the results obtained. I have found no difficulty in isolating very small motile bacteria under the $\frac{1}{12}$ oil-immersion lens by this method, and persons who have had no previous experience in the isolation of microorganisms by any method have succeeded in isolating blood corpuscles or bacteria after less than an hour's practice. The adjustments once made, the technique is nearly as easy as with the holder; the method may be used with one type of compound microscope as well as with another. But the greater amount of time and care required for adjusting new pipettes make this method less suitable than the first for one who is doing an extended series of selections or inoculations. Further, the second method is less suited than the first for dissection under the microscope, inoculation into cells, or for some other special applications of the technique to be mentioned later.

METHOD III

In the third method of isolation, all mechanical holders are dispensed with and the pipette is held in the fingers of the right hand. The moist chamber is supplied with drops of sterile broth and of the bacterial mixture, as in the other

methods, and placed on the stage of the microscope with the open end to the right. The pipette is made as usual, though it is advantageous to have the turned portion rather short and brought to an angle of about 50 degrees instead of at right angles. If the low power alone is to be used, it is focused on the edge of a drop of sterile broth and then lowered somewhat. If the high power is to be used, there is no preliminary focusing with the low power, but the lens is focused on the cover glass in the neighborhood of the edge of a sterile drop.

The pipette is held with the thumb and index finger of the right hand and steadied by pressing the other fingers against and beneath the stage of the microscope. The shank is held horizontally and the tip brought into the chamber past the objective. It is then held far enough from the cover glass to avoid any drop and moved back and forth until the capillary can be seen, often only as a shadow in the field. The pipette is then slowly withdrawn until the tip appears. This is then kept in view while the objective is focused on the edge of the drop of broth. After the tip is filled from the drop, the chamber is moved and the bacteria brought into the field. The pipette may be filled from a test tube before introducing it into the isolating chamber. If it is necessary to break off the point, scratch it very gently on the side of the tube. The rapidity with which the broth rises is a good index of the size of the opening.

The screws governing the mechanical stage and the fine adjustment of the microscope are manipulated by the thumb and second finger of the left hand, while the index finger is bent and braced against the pillar. The isolation is carried out as in the other methods. It is necessary to keep the point of the pipette continually in view during the process.

The advantages of this method are its simplicity and the rapidity with which the pipette may be adjusted into place and manipulated. The chief disadvantage is, obviously, the difficulty of properly governing the movements of the pipette with the fingers alone, especially under the higher powers. It is surprising, however, how steady the pipette can be held and how accurately it can be moved when the hand is well supported against the stage of the microscope. The isolation of organisms distinguishable under the low power is comparatively easy, and the difficulty of isolating cocci and other smaller bacteria under a $\frac{1}{4}$ - or $\frac{1}{8}$ -inch objective is not great after some practice. This method is not adapted to microscopes in which the fine adjustment and the screws of the mechanical stage

cannot be governed by the left hand in the position described above. Its scope is also limited to the simpler applications of the pipette method.

CULTIVATION OF THE ISOLATED ORGANISM

After the single organism has been isolated, it may be cultivated in situ on the cover glass or removed and grown elsewhere.

I. CULTIVATION IN SITU ON THE COVER GLASS

1. If only a few generations of growth are to be observed, one may simply leave the organism in the droplet in which it was isolated and place the cover glass over an ordinary moist chamber. Some organisms do not grow well in so small an amount of medium, while others will form a considerable number of generations. *Bacterium coli commune*, for example, will form 32 small elements in a droplet of broth about 10 microns in diameter. In order to prevent drying or undue concentration of the medium, the droplet should be placed near a larger drop of broth or of agar. It may be necessary to add to the moisture on the cover by placing slightly warmed water in the bottom of the isolating chamber just before transferring the cover, but it is obviously unsafe to add too much condensed moisture in this way, because the drops may run together.

2. With a fresh, sterile pipette (it is not necessary to make a fine-pointed pipette), liquid may be taken from a test tube or from a sterile hanging drop on the cover and added to the droplet containing the organism. This may be done under the low power. To avoid any possibility of taking up the organism with the second pipette, one may discharge the large drop near the small one and lower the pipette before the broth has spread to the droplet. Liquified gelatin, liquified agar, or any fluid or semifluid medium may be added.

3. A very convenient method, especially when a considerable number of isolations are to be made from the same source, is to place on the cover glass previous to isolation a series of drops of broth, melted agar, gelatin, or any other solid or fluid medium. The diameter of these drops will depend on the available space and the nature of the experiment—0.5 millimeter is, perhaps, the minimum and 2 or 3 millimeters a good average. These drops may be placed in a series of rows arranged with reference to lines on the cover, or any arrangement may be followed, so that any drop can be easily found

or registered according to its position (fig. 8). As many as from 50 to 60 drops may be placed on the same large cover.

Each organism as it is isolated is placed in a small droplet close to any one of these larger drops *c* (fig. 8), using the same pipette for all. When the series is finished and the small drops are examined to make sure that each contains but one organism, each small drop of a pair is made to fuse with the larger one. This may be done in several ways: (1) By means of a fresh pipette filled with sterile broth, fluid is added to the larger drop and the pipette withdrawn before the liquid spreads to the smaller. Or the smaller drop may be enlarged to meet the larger and the organism washed in. One may fuse all the pairs of the series with the same pipette. (2) If agar or a similar solid medium is used, one may pierce the large drop with a coarse pipette and, by moving the mechanical stage, slip the mass slightly until it meets the organism. This may also be done with a bent platinum wire without the aid of the microscope. (3) When the small droplet is very close to the large one, one may often fuse the two by adding water to the bottom of the isolating chamber sufficiently warm to cause enough condensed moisture to join the drops.

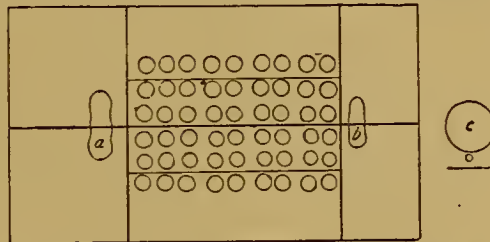

FIG. 8. A cover glass with droplets arranged for an extended series of isolations. *c*, a droplet shown on a larger scale with a small bacterium-containing droplet beside it.

The organism may be placed directly on the surface of the agar or gelatin, but the outlines of the droplet are less distinct and it is then more difficult to make sure that the droplet contains but a single organism. A drop of agar or gelatin may be placed near the center of a large cover, the organism placed on it, and a small cover pressed down on the organism. One may then observe the growth taking place between the two covers.

The moist chamber to which the cover is transferred should be as shallow as the size of the droplets will permit, so that there will be little air for the absorption of moisture from the cover. A form convenient for large cover glasses may be made by cementing strips of glass to a large slide. Immediately before transferring to the cover, it is well to increase the moisture on the cover slightly by placing warm water in the bottom of the isolating chamber, and it is advisable to add condensed moisture in the culture chamber by breathing on the bottom of it. Unless the number of inoculated drops on the cover is large, there should be extra drops of broth placed on it to

add to the moisture. After the cover is well sealed on, it is best to put the culture into a Petri dish or box, because a sudden change to a higher temperature may cause too much moisture to leave the cover and condense on the slide. These and similar precautions will occur to any one familiar with cultivation of organisms in the hanging drop; but special precautions must be taken where the drops are relatively small.

The growth of the single organism at the edge or center of the hanging drop, whether in a liquid or a solid medium, gives one an excellent opportunity of observing the development of young colonies. For instance, a single tubercle bacillus of some strains will give a very different type of growth in the bottom of a drop of broth than when left at the margin. If one desires to transfer the colony grown on the cover to a test tube, the cover is placed on the isolating chamber again and the colony transferred by means of the pipette under the low power or with a bent platinum wire without the use of the microscope.

CULTIVATION IN A MEDIUM APART FROM THE COVER GLASS

1. The organism may be taken up with a fresh sterile pipette already supplied with broth and discharged into a test tube containing a liquid medium, or it may be placed on the surface of a solid medium in a test tube or into the water of condensation. If it is desired to get an abundant growth on solid media as soon as possible, one may wash the surface with the water of condensation some hours after the organism has been transferred to it. The removal of the organism from the cover may be facilitated by adding a little sterile broth from the second pipette to the droplet just before taking up the organism. It is easy, of course, to transfer to a solid medium in a liquid state in order to obtain anaërobic conditions.

2. Where temporary growth is to be observed, one may take up the organism in a fresh pipette and leave the pipette in the holder. After any desired interval of time, the isolated organism with its offspring may be discharged on the cover and, after inspection, drawn into the pipette again. This method is sometimes convenient for organisms which do not grow well in a hanging drop.

3. If it is desired to observe growth on the cover glass and the cover on which the organism is isolated is for any reason unsuitable, the organism may be taken into a pipette, the pipette lowered, and a new sterile cover, supplied with broth or agar droplets, substituted for the old one. One has only to raise the pipette and discharge the organism into any desired place on the new cover.

4. In some cases it is convenient to transfer a series of isolated organisms, each to a separate test tube, without the loss of time necessary for a change of pipettes at each transfer. For this purpose the large cover is slipped to the left, so that about 2 centimeters of the top of the isolating chamber is free. An oblong piece of mica, about 2.5 centimeters by 4.5 centimeters in size and provided with a circular perforation about 5 millimeters in diameter, is sterilized in the flame and placed over the opening with its free edge in contact with that of the cover. A small sterile cover glass is placed over this opening. The isolated organism is taken up in a pipette and deposited on the smaller cover. The cover is then taken up in sterile forceps and placed into a liquid medium or on the surface of a solid medium in a test tube or Petri dish. Or a flattened platinum loop is moistened in a sterile fluid and placed with the flat side in contact with the top of the small cover. The cover will adhere to it, and may be easily lifted and transported. A new small cover is now put over the opening and a second organism placed under it. If necessary, the mica may be sterilized in the flame before receiving another cover. With organisms very sensitive to drying, it is best to place a small drop of broth on the underside of the cover before placing it on the mica. Where such a drop is used, the mica may be placed on the left end of the box, as shown in fig. 9. The isolated organism on the larger cover will, in that case, be better protected against drying, and it will not be necessary to cover the opening on removal of the mica for sterilization. It may be unnecessary to isolate organisms previous to transfer if the drop containing the bacteria is shallow and the bacteria relatively few, so that one can be sure that only one bacterium enters the pipette. Or, if a small drop contains a known number of bacteria, they may be removed and transferred one at a time. In any case, the bacterium may be inspected in a droplet on the small cover to make sure of its isolation. When these small covers are removed to a solid medium, opportunity is afforded for observing the growth of the bacterium between the cover and the medium.

5. By attaching two holders to the stage of the microscope, two pipettes may be used simultaneously (fig. 15). An organism may be isolated with one pipette and immediately picked up by the other and transferred, or may be allowed to grow in the second pipette. By the use of either this method or the one described under 4, one may remove bacteria from a test tube, isolate a single organism, and place the isolated organism into a new test tube after a stay of only a minute or so on the cover

glass. I have used these methods in the study of the growth rate of *Bacterium coli commune*.⁸

6. The organism may be drawn into a short capillary tube

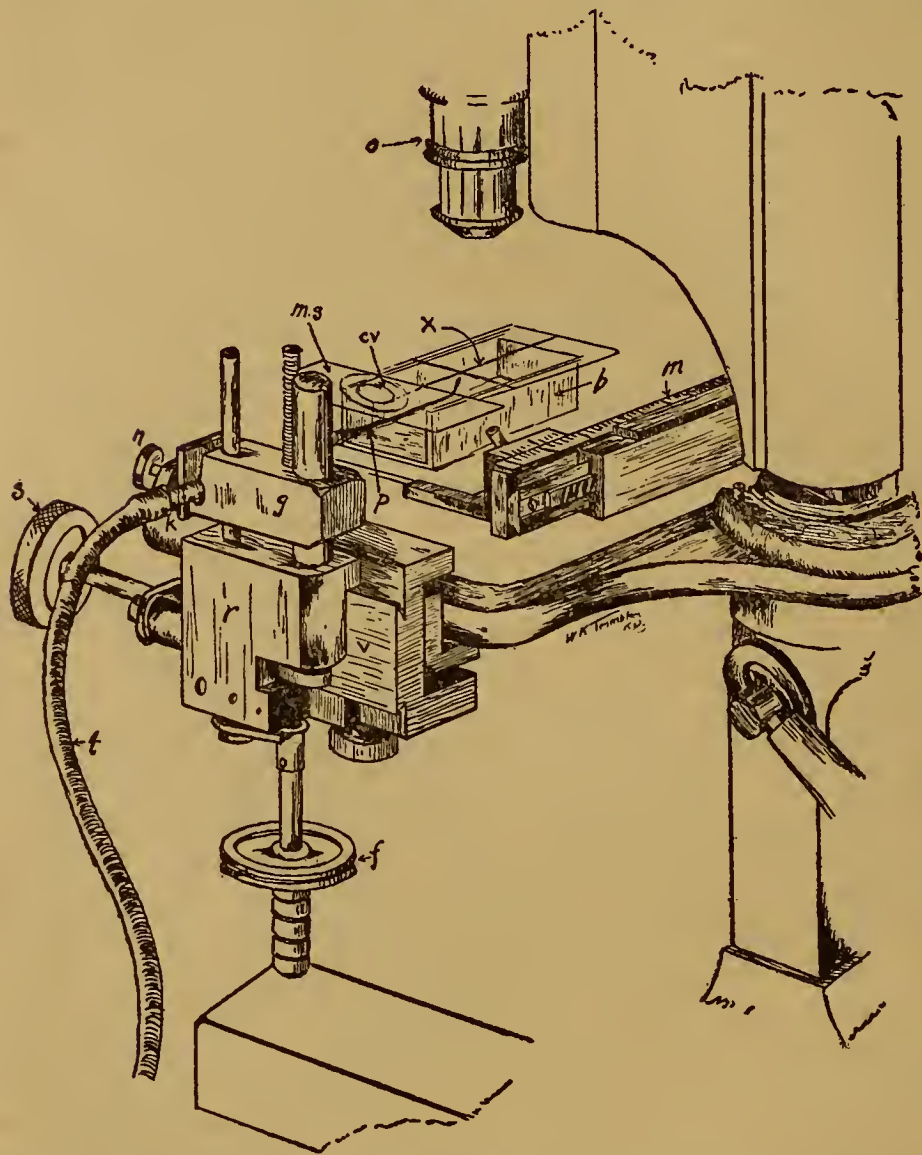

FIG. 9. Two-movement pipette holder, pipette and isolation chamber arranged to illustrate method of transferring single isolated bacteria by means of a perforated mica plate. *ms*, mica plate; *cv*, small cover glass over perforation; *x*, large cover glass; *p*, pipette; *g*, up-and-down adjustment of holder moved by screw *f*; *r*, to-and-fro movement regulated by screw *s*. (From The Journal of Infectious Diseases.)

of very small diameter and the tube placed on the underside of the cover where growth may be observed under high powers—the oil immersion, if desired. Glass tubing is drawn out into a very

⁸ *Journ. Infect. Dis.* (1908), 5, 379.

fine capillary, and this is cut into any desired lengths in a sterile Petri dish—1 centimeter is a convenient length. An ordinary pipette is made, moistened in sterile fluid, and the capillary made to cling to it as shown in fig. 10. Care must be taken not to get liquid into the short capillary. The pipette is adjusted in the usual manner. The capillary is partially filled by touching a small hanging drop of broth or other fluid medium, and then the organism is drawn in by capillarity. The pipette is then turned and the capillary deposited on the underside of the cover in a dry area or in a drop of fluid, as desired. I have grown yeast cells in a capillary so narrow that multiplication was possible only in the form of a chain. Plague bacilli in the center of such capillaries have shown involution forms not observed in the control outside.

Again, an ordinary pipette may be drawn to a very fine capillary, so fine that human red blood corpuscles must bend at the edges in order to lie in it. Organisms may be taken up in this capillary and the capillary flattened against the cover and observed under the oil immersion while still attached to the pipette. It is then possible to discharge all or a part of the contents of the pipette into a hanging drop. The tip may be sealed by touching it to a hanging drop of sterile vaseline under the cover, then removed from the holder, and placed in the incubator. It may later be brought under observation again. The sealed tip may be broken off, under microscopical control, by means of a separate, coarse-pointed pipette held in a second holder clamped on the microscope. The organism may then be discharged into a hanging drop.



FIG. 10. A capillary tube in position for taking up isolated organisms.

INOCULATION INTO ANIMALS

The isolated organism, or any small number desired, may be taken up and immediately inoculated into an animal, subcutaneously, intravenously, or intraperitoneally. A pipette of slightly different construction is used for this purpose. Tubing of tough glass, not too thin walled, is drawn out into a capillary slightly thicker than that of an ordinary pipette. The tip is made and bent as usual, although the bent portion should have as a base some of the thicker part of the capillary. The pipette is supplied with salt solution or broth from a test tube. Care should be taken to avoid breaking off too much of the tip

against the walls of the tube. It should be filled 4 or 5 millimeters back of the bend. It is then adjusted as usual and the organism taken from the droplet in which it is isolated. The organism must actually enter the tube and not adhere to the margin of the opening. The tip is now brought into a hanging drop of sterile broth or salt solution for a few seconds, so as to wash the organism well back from the tip. The pipette is removed from the holder, and is ready for inoculation. The index finger and thumb hold the capillary; the middle finger is extended and the end of it pressed against the bend of the pipette, in order to push the point through a fold in the skin. By blowing into the rubber tube, the liquid in the tube is injected, the liquid back of the bend serving to wash out the organism. The point usually enters easily into the skin of ordinary laboratory animals, and leaves a wound scarcely discernible with a lens. If the opening in the pipette is too fine, there is sometimes difficulty in forcing out the dose. In this case, one may enlarge the opening by breaking off a small portion against any sterile surface. It is obvious that a tip broken off obliquely will penetrate the skin much more easily than a blunt one. If desired, one may wash back the organism with sterile fluid in the test tube just before breaking off the tip; but, in any case, it is best to wash it a short distance back before removing it from the isolating chamber. Large animals with very thick skin may be inoculated in the mucous membrane of the mouth. I have inoculated carabaos in this way. Any desired number of organisms may be counted out and inoculated in one dose; or one organism may be isolated, allowed to grow in the hanging drop, and its offspring inoculated, leaving one or more to grow in the hanging drop as a control.

Special experiments,⁹ in which the organism has been discharged into a nutrient medium instead of into an animal, have shown that the organism comes out of the pipette and does not adhere to the glass. Further, I have obtained a fatal infection in mice following the inoculation of a single anthrax bacillus¹⁰ and a considerable proportion of positive results with single plague organisms inoculated into monkeys and guinea pigs.¹¹

A modification of the inoculation pipette is of advantage in some cases, for example, in the piercing of a very tough skin or in intravenous or intraperitoneal inoculation. Here the tip of a

⁹ *Journ. Infect. Dis.* (1909), 6, 634.

¹⁰ *Ibid.*

¹¹ *This Journal, Sec. B* (1912), 7, 251.

rather thick capillary is drawn out into a hair point, *d* (fig. 6), and the end cut off, as described in the technique of making ordinary pipettes. Only the hair point is turned up. This can usually be done by simply holding it above the flame of the microburner. The upward draft of hot air softens the glass and bends it vertically. This pipette is supplied with liquid; the organism is taken up and washed well back as described for the ordinary inoculation pipette. Then the hair point is broken off, and one has a straight, very sharp-pointed needle with the dose back of the tip and enough liquid present to wash it out. Such pipettes with the contained dose may be sealed at the tip and kept until a convenient time for inoculation. This modification has been used in the inoculation of doses of *Bacillus tuberculosis* consisting of one or few bacilli.¹² If desired, the dose may be discharged into the needle of a syringe and inoculated in that way. The pipette is gradually withdrawn from the needle as the dose is discharged into it. Semifluid agar or other substance may be placed in the syringe and in the base of the needle in order to carry out the dose. In most cases it is unnecessary to use the syringe. The technique of inoculation into living cells will be described below.

DETAILED DESCRIPTION OF CERTAIN STEPS IN THE ISOLATION METHODS

MOISTURE

The necessity of keeping the proper amount of moisture in the isolating chamber cannot be overemphasized. Drying or over concentration of the medium is fatal to some organisms, besides increasing the difficulty of isolation. The index of the proper amount of moisture is the presence on the cover of very small droplets of condensed moisture, the film resembling fine stippling (photomicrograph, Plate I, fig. 1). This stippling of condensed moisture also aids the eye materially in locating the edge of droplets. Much depends on a proper amount of vaseline on the cover (see page 314). If large droplets of condensed moisture are formed, it becomes difficult to make the small droplets necessary for isolation. In this case one usually finds a suitable area in the neighborhood of a large hanging drop. One can usually supply the necessary film of moisture by placing slightly warmed water in the bottom of the isolating chamber. Distilled water may be kept conveniently at hand in a small reagent bottle closed with an ordinary medicine dropper. The

¹² *Journ. Med. Research* (1909), 20, 1.

dropper is filled and the water in it heated slightly over the flame. The temperature of the water is gauged by the temperature of the room. One can usually judge the condition of the moisture film with the naked eye. As a rule, it is best not to use the outer third of the cover for isolation. By keeping this outer third of the cover supplied with hanging drops of agar or broth, the moisture of the other two-thirds of the box may be increased. Very constant conditions of moisture may be obtained within a long, narrow area on the cover inclosed by a barrier of agar. It is important to have the cover well sealed to the edges of the chamber in order to avoid convection currents. Drafts of air on the laboratory table should be avoided, especially those blowing toward the open end of the chamber.

One may protect the open end of the box by a piece of moistened filter paper provided with a slit for the capillary portion of the pipette. A hood of moistened blotting paper (*H*, fig. 1) is still more convenient. A slight modification of the isolating chamber will assist in protecting the under surface of the cover in special experiments. A glass strip is cemented to the slide just outside of the chamber in such a way as to form a groove into which a piece of moist blotting paper may be inserted in an upright position, or the blotting paper may be slipped into the chamber and held upright by the sides. This method of protection leaves less working room for the pipette, but this difficulty may be avoided by bending the end of the pipette into



FIG. 11. A pipette constructed for use above a barrier of blotting paper.

the form shown in fig. 11. Here the tip of the pipette is just above the line of the capillary, and this arrangement allows one to work with the capillary of the pipette above the barrier of blotting paper.

I have used an isolating chamber, a portion of which is wholly sealed by means of a trap filled with water or mercury, *t* (fig. 12). The pipette capillary is bent into the form illustrated in the figure and adjusted into the chamber. If a capillary of hard

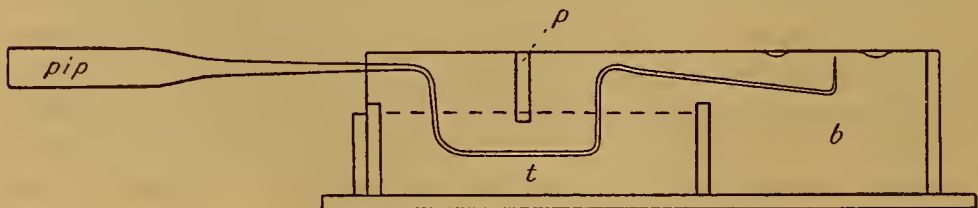

FIG. 12. Special isolating chamber in longitudinal section. The chamber *b* is closed at the side by the trap *t* and partition *p*.

glass is used, little difficulty will be found in bending it into any desired form over a small flame. Then the partition *p*, which fits into grooves at the side of the isolating chamber, is slipped down into place, and the cover is put into place and sealed with vaseline. An oxygen-absorbing reagent may be placed in the compartment *b* and a wholly or partially anaërobic condition attained.

Such a device is unnecessary for ordinary work, and even the moist paper protecting the open end can usually be dispensed with. If the bottom of the chamber is well supplied with water and the cover well sealed on, small droplets will remain on the inner half of the chamber for hours, even when the end is uncovered and the apparatus unprotected by a bell jar. By taking very simple precautions, one can work in a very warm and dry room.

DANGER OF CONTAMINATION

Danger of contamination is very small, less than when ordinary plate cultures are used, as there is no strong current of air entering the chamber. Droplets of broth remain sterile for many hours with the end of the chamber open and unprotected. In work where special precautions are to be taken, one may protect the end of the chamber with moist filter paper or the paper hood while the pipette is in place, and at other times keep the chamber on a glass plate protected by a bell jar or crystalizing dish.

PREPARATION OF ORGANISMS FOR ISOLATION

As stated above, no preliminary dilution of the organisms to be isolated is necessary. The material may be taken from any source, and the emulsion of organisms may be of any density. The organisms to be isolated may be in the majority, or they may be surrounded by thousands of other organisms of the same or another species. A single red corpuscle may be easily isolated from undiluted blood. In selection experiments, one may separate any aberrant organism from myriads of others of the same sort. The only requirement is that the organism is recognizable and large enough to be seen under an oil-immersion lens. Animals, unicellular algæ, or spores of fungi may be removed from a thick emulsion of bacteria, washed with the pipette, and isolated. Bacteria may be separated from pus or other pathological material.

There is always the possibility that a nonmotile organism may not be viable. One can often save the labor of making a long series in search of a living organism by a short prelim-

inary cultivation. The material is placed in a hanging drop, and some suitable nutrient material is added. The drop is inspected and set aside for a preliminary growth. Living organisms may then often be recognized by the chains or groups formed in multiplication. By isolating such a group and selecting an individual from it, one is practically sure of obtaining a viable organism. Spores of fungi may be left until the hypha of germination has begun to form, and then they may be isolated. This preliminary growth need not be continued for more than an hour or two in the case of many bacteria and fungi. One may make a preliminary separation of motile organisms by placing the material containing them at one end of a long hanging drop. They may be picked up after they have swarmed to the farther side of the drop. This same device may be used in the partial separation of animals or zoöspores of fungi or of algæ from bacteria.

A more motile organism may be partially or wholly separated from a less motile one by this method. By using a peptone solution, cholera vibrios in a drop of fæces may often be separated sufficiently for an agglutination test.

The separation of spores, cysts, or living animals from bacteria is usually easy. The larger organism is isolated and placed in a droplet, the smaller the better. The bacteria in the end of the pipette are now discharged on the cover at a convenient distance from the hanging drop, and sterile fluid is added to the isolated organism. If desired, this fluid may be taken from a large hanging drop on the cover. The liquid surrounding the spore or animal is now removed and fresh liquid is supplied, or the organism may be picked out and discharged in a new droplet. This process is repeated until the organism is washed free from bacteria. The process is usually done most conveniently under the low power. The organism in a small hanging drop may be inspected with the high power before being transferred. If necessary, a few remaining bacteria may be removed from the spore with a finer pipette, even loosening them from the side of the larger organism. If the bacteria are embedded in some gelatinous material surrounding the spore or animal, it is sometimes impossible to remove them, but I have had no difficulty in wholly freeing amœbæ, in cyst or motile condition, from bacteria. The process of washing the spore or animal usually requires only a very few minutes.

A bacterium may be washed free from any animal exudate in this way. I have obtained successful infections with doses of a single plague bacillus and of a single anthrax bacillus which

were washed in salt solution before inoculation. In washing small organisms, a fine pipette is brought to the edge of the droplet containing the cell and the liquid is removed, leaving the cell in contact with the cover. Fresh liquid is substituted, and the process repeated as often as desired.

It is often difficult to remove bacilli of tuberculosis and some bacterial spores from a hanging drop after they have settled to the layer of surface tension at the bottom of the droplet. The liquid passes into the pipette, but the cell remains stranded on the cover. This difficulty may be avoided by taking up these organisms before they have settled, or by placing the mouth of the pipette directly over the cell. Bacilli of tuberculosis may be made to cling to the side of the tip of the pipette and transported in that way. The peculiar behavior of these organisms may be due to the fat or mucus surrounding them, as most cells do not give this difficulty. It is difficult to remove leucocytes from a hanging drop of blood or any dilution rich in serum when they have once settled to the bottom of the hanging drop. They may often be isolated by bringing the mouth of the pipette directly under them.

NUTRIENT MEDIA

All media of the ordinary sorts may be used in this method, and where only small quantities are needed one has a wide range of possibilities. Quantities of medium may be repeatedly taken from the same test tube if one takes proper precautions against contamination. A soft agar can be conveniently obtained by melting the very top of a slant and allowing a portion of the liquified agar to flow into the water of condensation. By mixing different proportions of the liquified agar with the water of condensation, one may obtain various degrees of stiffness. Sufficient liquid for small hanging drops may be taken from a small blister or from the body of an insect or other animal; or, where the inoculation pipettes are used, from the contents of a living plant cell or microscopical animal. If a small quantity of serum free from corpuscles is needed, a deep hanging drop is made of the whole blood, and, when the corpuscles have settled to the bottom of the drop, serum may be drawn from its margin. A bacterium-free liquid from the cultures of some microorganisms may be obtained in the same way.

ILLUMINATION

The illumination of objects on the cover during isolation may be improved by the use of a projection condenser which focuses the light some distance above the top of the stage. Either day-

light or artificial light may be used, but a fairly strong illumination is advisable, especially when the higher powers are used. The oil immersion can be readily used over the isolating chamber without resorting to any special illumination.

PIPETTES

Pipettes may be made some time before use and kept in a sterile chamber or placed in a sterile test tube or flask with the shank held in place by the cotton plug, somewhat as shown in fig. 16. It is usually more convenient, however, to make the pipette just before use. A very convenient plan is to close the pieces of glass tubing intended for pipettes at one end with cotton and to draw them out into a coarse capillary at the other. The capillary is sealed at the tip, and the pipette sterilized in the hot-air sterilizer. A number may be sterilized and kept in stock ready for use. The coarse capillary may be drawn out and made into a tip for isolating, or may be simply turned up in the Bunsen flame and broken off for use in placing the preliminary drops of sterile liquid or solid media on the cover.

GAS FOR THE MICROBURNER

When natural gas is used, it is sometimes difficult to keep the small flame lighted. This can be remedied by causing the gas to pass through a bottle containing benzine or other enriching fluid.

SPECIAL APPLICATIONS OF THE PIPETTE METHOD

ISOLATION OF ORGANISMS FROM QUANTITIES OF WATER LARGER THAN HANGING DROPS

Sometimes it is desirable to isolate algæ, protozoa, bacteria, or other organisms from water or from a culture in which they occur in such small numbers that one cannot find them readily in the hanging drop. In this case, a Petri dish, a watch glass, or other receptacle containing the organisms may be placed on the stage of the microscope and a pipette, bent as shown in fig. 13, may be adjusted in the holder. The capillary need be bent only enough to avoid the edge of the dish. The point of the pipette is made as fine as desired, the opening being suited to the size of the microorganism. The tip is bent down obliquely, if the organisms sought are likely to be at the bottom; or bent upward, if they are to be sought at the surface. It is possible to scrape the bottom with the pipette and loosen and take up any adhering amœbæ or spores of algæ. When the organism sought is taken into the pipette, the tip is raised above the surface of the water, the Petri dish removed, and an ordinary isolating

chamber, supplied with a cover, is placed on the stage. The pipette is then turned point upward and adjusted so that it may enter the chamber. The tip is focused under the low power, and the organism is discharged into a hanging drop on the surface of the cover. It may then be washed free from bacteria or other organism if desired; it may be grown on the cover or transferred to a watch glass, a test tube, or other receptacle.

The low powers of the microscope are most convenient for this work, but a $\frac{1}{8}$ objective may be used for smaller organisms. In this case, a flat piece of cork is perforated with an opening about 1 centimeter in diameter and the opening is enlarged funnel wise on one side so as to admit the objective. A cover glass is sealed with vaseline to the other side of the cork, and the float is placed cover side down on the water. One may adjust

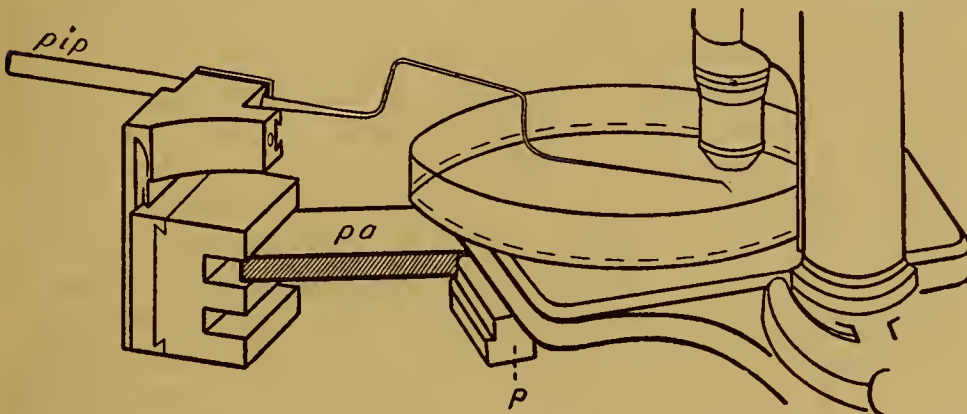

FIG. 13. A special pipette in position for isolating organisms from the bottom of a Petri dish. *p* and *pa*, metal plates screwed to the stage for the attachment of the pipette holder. The complete pipette holder is used, but only a portion of it is shown in the figure.

a pipette under the float and focus the higher power of the microscope on the tip and the liquid surrounding it. If it is desired to select organisms deeper in the liquid with the high power, a short, thick rubber tube or hollowed rubber stopper is placed around the base of the lens and the free margin smeared with vaseline. A large cover is placed on a dry slide, and the objective with the rubber tube is lowered to the cover. The smeared edge reaches the cover and seals fast to it, and the lens is made to descend until one can focus below the cover. Any stained object on the slide will facilitate the focusing. On raising the objective, the cover comes up with it; then it may be lowered into the water containing the organisms to be isolated. If organisms cling to the cover on bringing out the objective, they may be picked off from the cover with the pipette, or the pipette may be adjusted and isolation carried out as in the case of the cork float.

FIXATION AND STAINING

Fixation and staining can be carried out in hanging drops with the pipette. The stain or fixing reagent may be placed under the cover with a platinum loop or coarse pipette and applied with the isolating pipette to the organism. The medium in which the cell lies may be withdrawn and the cell washed, following the method outlined for freeing cells from bacteria or serum (see page 337). The fixative, and then the stain, may be applied with the pipette. The same pipette may be used for both by washing it between each use with water or other fluid in hanging drops. If the fixative is volatile or cannot be easily washed out of the pipette, one may keep it in a separate pipette. A second holder may be used or the pipette removed from the holder and the one containing the stain substituted. After staining, the cell may be washed and decolorized if necessary. If it is desired to mount the stained preparation in balsam, albumen or other fixative may be applied and the location of the cell marked by Brunswick black or India ink on the upper side of the cover. The preparation is then dehydrated by drying on alcohol and mounted. Or the cell or colony may be located, and the cover removed, dried, and stained. In Plate I, figs. 3-7, a photomicrograph is shown of a preparation of *Bacterium coli*. By means of successive isolations, a series of 5 droplets was obtained, containing respectively 1, 2, 4, 8, and 16 bacilli. The preparation was dried in toto, stained, washed, and mounted without the loss of a single bacillus in the series. I have also used this method in staining young colonies of *Bacillus tuberculosis* derived from an isolated single cell. Drops of different stains may be dried on a large cover. When they are to be used, the cover is placed over an isolating chamber, and the stain, dissolved in the water of condensation, is taken up with the pipette. By changing covers and using two pipettes, one may obtain a great variety of combinations.

SEROLOGICAL TESTS

I have tested only agglutination and precipitation by the pipette method. The agglutination in hanging drop is especially practicable with motile bacteria rapidly agglutinated, such as vibrios of Asiatic cholera and typhoid bacilli. The serum in proper dilution is taken into a pipette and applied to the edge of a hanging drop containing the bacteria. This method gives very striking results with vibrios. When a very small quantity of cholera agglutinating serum is applied at the edge of an emulsion of cholera vibrios,

a ring of agglutinated vibrios forms instantly and all vibrios which come into this ring are agglutinated at once. If some other vibrio is substituted for cholera, not only does agglutination with the cholera specific serum fail, but the vibrios are attracted by the serum. A good method is first to make a drop of diluted serum very near the bacterial emulsion, then to connect the two; the serum will flow through the connecting channel into the larger drop.

This method has been found especially practical in testing out a large number of colonies on a plate. A series of drops of salt solution, peptone water, or other fluid is made on a large cover glass placed over the isolating chamber, and bacteria from various colonies are added to them. Different agglutinating serums may be placed in hanging drops on the same cover or on another cover placed over a second moist chamber. All drops may be tested with a given serum, the pipette washed in a hanging drop of salt solution, and a second serum applied if necessary. If desired, the serum may be used in low dilution in order to eliminate negative colonies. Those which give a positive or doubtful test may be further tested by the macroscopical agglutination method. One may dispense with the pipette and test by placing the serum on the under surface of the cover with the loop and connecting it with the emulsion drop to be tested, but the pipette gives more precise results, and is more convenient, especially where a large number of tests are to be made.

By the same general method a precipitating serum may be added to a hanging drop of the dilution to be tested. The formation of the precipitate may be observed microscopically. Application of this technique to other serological work as well as to various microchemical tests are possible, but I have had no extended experience in any but the above.

EXPERIMENTS ON CHEMIOTAXIS

Experiments of this nature may be carried out with the technique described under serological methods, or by using the capillary tubes in flasks as described on page 346. It would seem possible to test the effects of currents of electricity in hanging drops, with or without organisms. Two pipettes may be used for the two poles by filling them with mercury, as in the technique of inoculating cells. One could insulate one pipette by drawing some nonconducting liquid into the lumen and, by application of pressure to the pipette, eject the nonconductor and make a mercury connection. If desired, this process may be conducted with both pipettes in the same animal or living vege-

table filament. These methods have not been tested by me, and are given only as suggestions.

DILUTIONS

It is possible to make dilutions of a serum or other fluid under the microscope with the pipette. A pipette with a tip bent somewhat backward is made, and a mark is made on the capillary below the point of the tip. The pipette is filled to the mark with serum by dipping the tip in a hanging drop, and then the mark is brought into focus with the low power. The contents are ejected in a hanging drop, and an equal quantity of salt solution is added. These are mixed in the pipette, and one or more portions of the first dilution are added to one or more of salt solution, and so on.

If desired, a hanging drop may be made to contain a measured quantity of liquid. For measuring, a special pipette is made (fig. 14). This capillary is made of hard glass, preferably, and after a point is made and turned the capillary is bent into the position shown and the upper side of the triangle is marked with a very



FIG. 14. Special pipette for measuring small quantities of liquid.

fine capillary or pen dipped into India ink or asphalt cement. After the pipette is placed in the holder, one can estimate the cubic contents of the different segments of the capillary by

measuring the length and diameter of each with the eyepiece micrometer. The tip is brought into the center of the low power and filled from a large hanging drop. By focusing down and moving the nose piece, or the right-and-left adjustment of the pipette holder, to and fro, one can bring the different marks into view and discharge a hanging drop containing the quantity lying between any two marks. If desired, the contents of a given portion of the capillary may be more exactly measured by filling it with mercury and weighing the amount of mercury ejected when it is emptied.

It is hardly necessary to state that these measuring methods are applicable only when the amount of condensed moisture on the cover is constant and small. However, the method has been found useful in making a series of drops of approximately the same size. If very small drops are needed, the eyepiece micrometer may be focused on the capillary and used in determining the length of the column of liquid to be ejected.

WARM BOX

A series of isolations can be made with the microscope inclosed in a warm box. In an apparatus used by me for determining

the growth rate of bacteria,¹³ the microscope was inclosed in a wooden box which was covered with a cloth jacket lined with asbestos wool. It was warmed by electric coils, and the temperature was regulated by a thermoregulator. The adjustment screws of the pipette holder were reached through a small door in one side, the rubber tube was passed out through a small opening at the top, and the mechanical stage was moved by means of rods passing through openings in the top of the box and engaging the screws of the stage. With this apparatus it was possible to keep the moist chamber at a constant temperature throughout an experiment lasting a day or more. A bacterium was isolated, and when it had developed two or four offspring a daughter cell was isolated, placed in a new drop, and so on. Thus a record of the number of generations formed in a given time was kept. The method in which the movements of the pipette are governed by a simple microscope or other holder apart from the compound microscope would be adapted to a warm box too small to admit both microscope and holder.

DISSECTION

Some of the simpler dissections in the hanging drop may be done with a single pipette. In order to break apart a clump of bacteria, one may draw away the liquid surrounding the clump and press apart the bacteria with the pipette tip. A yeast cell containing spores may be broken open and the spores separated with the ordinary blunt-pointed pipette. With the pipette drawn to a sharp point (fig. 6), other manipulations are possible. An amœba, when stretched out on agar, may be cut into two living parts, with little loss of cell contents, by a side stroke with the sharp point. This process is easier if the tip is bent somewhat obliquely as shown in *c* (fig. 19). The nucleus of an amœba may be removed by introducing the point close to the nucleus when the latter is at the margin of the animal. A side movement, made with the mechanical stage, removes the nucleus with little loss of protoplasm, and the enucleated amœba continues its movements. The tip of the dissecting needle may be broken off and transformed into a pipette for staining or other purposes.

I have succeeded in breaking open human red blood corpuscles with a single point, the size of which bore about the same relation to that of the corpuscle as the blunt end of a pencil does to the palm of the hand.

¹³ *Journ. Infect. Dis.* (1908), 5, 379.

Two dissecting needles may be employed by the use of the two pipette holders. The second holder may be clamped to an elongated plate screwed to the stage of the microscope (fig. 15) or to any firm support apart from the microscope. In order to bring both points into the moist chamber, a bend in one of the capillaries may be necessary. I have used an isolating chamber with a side opening, so that the second pipette holder could be clamped on the front of the stage. However, it was

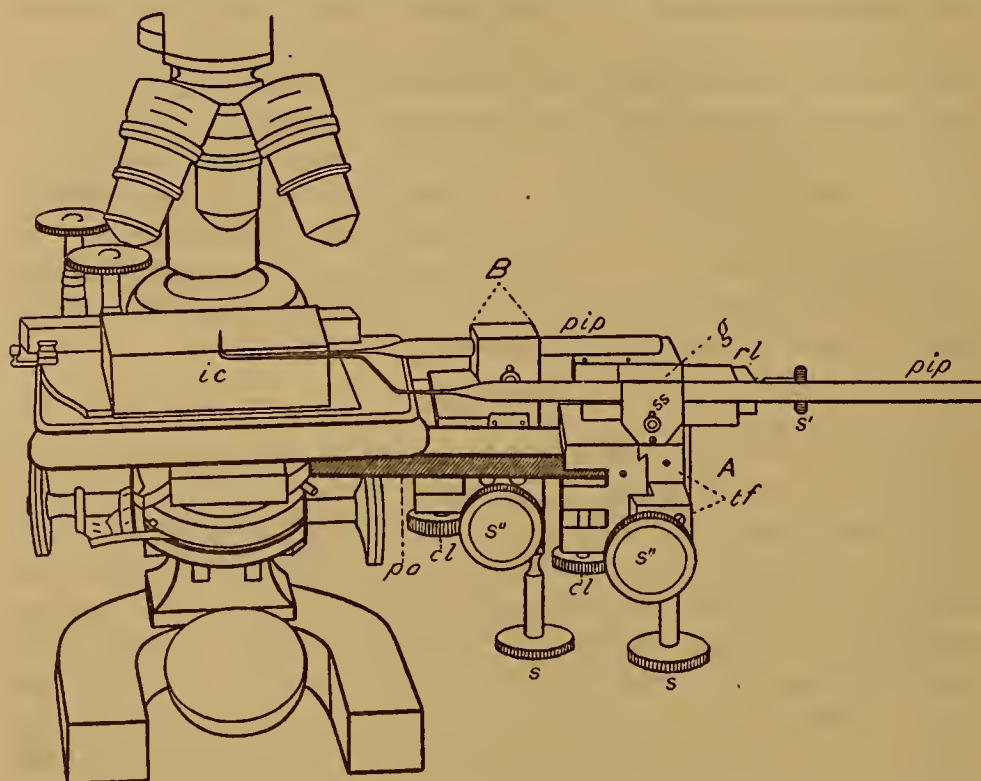

FIG. 15. Microscope with two pipette holders, each containing a pipette attached to the stage by means of metal plates. Seen from the back. *A*, a three movement, and *B*, a two movement holder; *tf*, adjustment, governed by screw *s''*, for moving the pipette to and from the observer. The other letters correspond to those shown in Figs. 1 and 2.

found difficult to keep the isolating chamber moist with two openings in it without using a special closing device, so the position first described is preferred.

With both holders provided with three movements, one has at command two dissecting needles, with rigid points as fine as the end of a colon bacillus, each of them movable in all directions of space. In addition, it is possible to move the organism in two directions by means of the mechanical stage. Dissection may be carried on under the oil immersion, and either needle may be transformed into a pipette at will. The wall of *Spirogyra* may be opened and the nucleus removed, microscopical animals

dissected, and various other manipulations performed. Either one or both of the pipettes may be provided with mercury and used for cell inoculation. It is better to use hard glass in making fine points for dissection.

For the dissection of very delicate, soft objects, as blood corpuscles and some protozoans, I have made use of sharp stiff hairs, taken from the body of a house fly, and also of very fine-pointed needle crystals. A pipette with a fairly large opening is made, and the hair or crystal drawn partially into it, the thicker end within. The fine point projecting from the tip of the pipette is then used as a probe or dissecting needle. The same pipette may be used as a holder for a considerable variety of these fine tools.

THE PIPETTE AND ISOLATING CHAMBER USED AS SEPARATE UNITS

There are some uses of the pipette or of the isolating chamber as separate units which may merit a short description.

The isolating chamber has been found a very useful adjunct to the microscopist in furnishing a convenient method of examining material in hanging drop. One has only to place with a loop a drop of the material to be examined under the cover glass, and the same cover glass may be used for the examination of many colonies of bacteria, of samples of fæces, of protozoans, or of microscopical plants. If desired, the cover glass with the samples may be sealed on a ordinary moist chamber for further observation. A pipette containing an agglutinating serum or some simple stain may be used in connection with the hanging drops.

The pipette will often be found convenient in fishing colonies from a plate in which the colonies are too close together to be transferred with the platinum needle. The Petri dish or other plate may be held in a clamp in an inverted position over the stage; where this is not practicable, an area of the medium containing the colonies may be transferred to a large cover and placed over an isolating chamber.

A straight, fine-pointed pipette provided with a rubber tube may be used for inoculating microorganisms into insects. A point much finer than that of a syringe needle may be made and materials inoculated between the joints of the leg or into any part visible under a hand lens. If a very fine point is needed for inoculations into animals or plants, the pressure apparatus described in connection with the cell injection technique may be used. In order to gain freedom of movement, the pressure pipette may be suspended by a cord. The raising

and lowering of the cup containing cold water may be done by an assistant. I have successfully inoculated defibrinated human blood into living mosquitoes by this method.

A special application of the pipette may deserve a fuller description. In this technique the separation of motile bacteria is accomplished by the use of pipettes supplied with fluids attractive or repulsive to certain species of bacteria. For certain

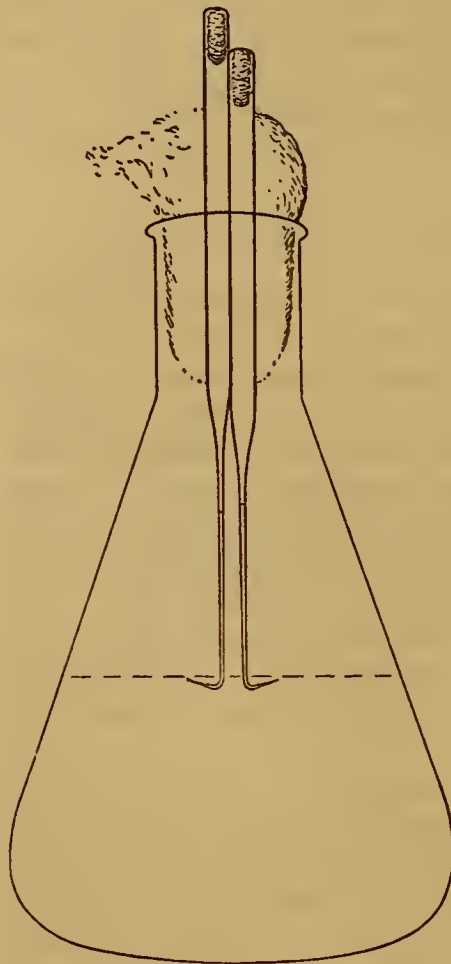

FIG. 16. Apparatus for attracting certain motile bacteria into pipettes.

experiments specific agglutinating serums may also be used. A short glass tube is plugged at one end with cotton and drawn out into a capillary at the other. It is then sterilized in the hot-air sterilizer. An ordinary pipette is made from it, supplied with the fluid to be used, and is placed in a test tube or flask containing the mixture of bacteria, as shown in fig. 16. A perforated cork may be used in place of the cotton plug, and, in either case, two or more pipettes may be introduced into the same flask. The pipette is supplied with liquid from a test tube and more drawn in than can be supported by capillarity. The liquid flows out of the capillary until only the column supported by capillarity remains. The slow diffusion of the liquid from the point forms a zone of attraction for motile bacteria positively chemotactic to the fluid in the pipette, and they may finally enter the pipette and grow in

the capillary. It is easy to transfer them by removing the cotton plug from the pipette and withdrawing some of the liquid at the top of the column by means of a fine glass capillary or a long platinum needle. If it is desired to continue the use of the apparatus after the removal of liquid for examination, the pipette may be raised slightly after withdrawal of the liquid, so that no additional bacteria will be drawn into the tip by capillarity, or new liquid may be introduced into the capillary.

I have used this apparatus in some experiments with mixtures of cholera vibrios and *Bacillus pyocyaneus*. A pipette charged with a dilution of cholera agglutinating serum will attract only *B. pyocyaneus*, while a pipette supplied with *B. pyocyaneus* agglutinating serum will furnish pure cultures of cholera from the same mixture, even though *B. pyocyaneus* has so far overgrown the other that the cholera can no longer be detected by the plate method. If the bacteria are not in pure culture in the pipette, one or the other species may be so far in the majority that it is easy to separate them by the plate method. The experiments with cholera mixed with other bacteria are as yet unfinished, but the technique is far enough developed to justify a brief preliminary description here. There are many variations possible in this technique, some of which will be described in a subsequent article.

The flask, shown in fig. 16, is a very convenient holder for pipettes temporarily removed from the pipette holder. The tip of the pipette is left just above the surface of the liquid, so that it will remain moist. Agglutinating serums, stains, or other fluids may be kept for days in this way, ready for use at any time.

INOCULATION INTO LIVING CELLS¹⁴

The technique of inoculation of microorganisms, stains, fixatives, or other substances into the protoplasm or vacuoles of living cells is subject to some requirements not found in the simple isolation of cells. The tip of the pipette must be of such a fineness as to minimize the injury to the cells inoculated and of sufficient rigidity to pierce the cell wall. An injection force has to be employed sufficiently great to overcome cell pressure, capillarity in the very fine tip, and any obstruction in it. A pipette point, such as is shown in *a*, fig. 19, will meet the first requirements, and the necessary force for injection is obtained by the expansion of mercury. The isolating chamber, pipette holder, and microburner are the same as those described under method I.

The special pipettes may be made of the same sort of tubing as for isolating pipettes, although glass with a slightly thicker wall (about 0.7 millimeter in thickness) is preferable. Either hard or soft glass, if tough and of good quality, may be used. A piece of tubing about 35 centimeters in length is bent at one end into the form shown in fig. 17. The distance from the top to the bottom of the curved portion should be about 5 centimeters.

¹⁴ First described in *Journ. Infect. Dis.* (1911), 8, 348.

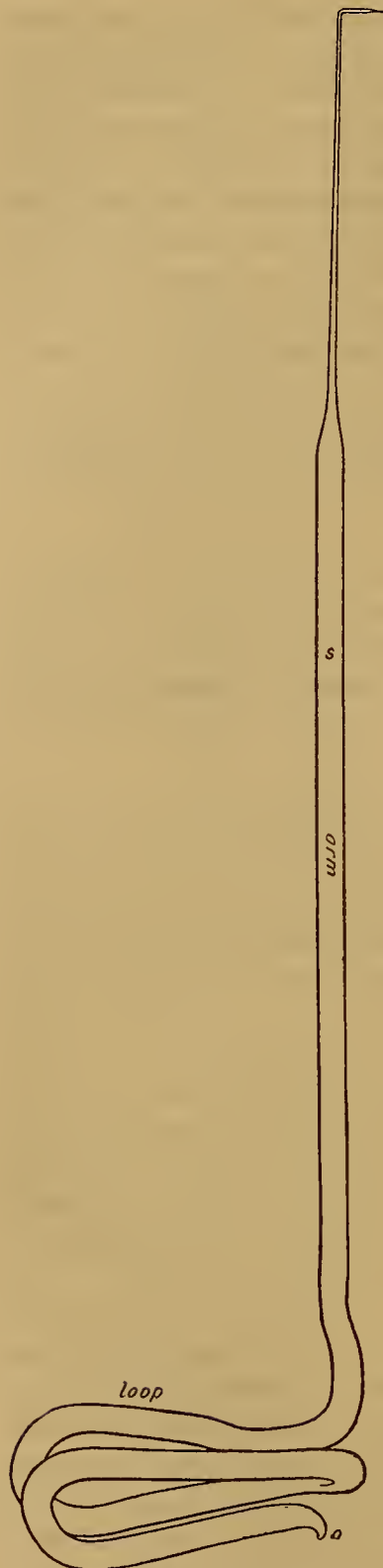

FIG. 17. Pipette for injecting substances into living cells. Completed.

For convenience in description, the curved portion will be designated as the loop and the straight portion as the arm. It is not essential to have the exact form of loop as that represented in the figure. Sufficient bends should be made to contain a considerable quantity of mercury and to make the instrument sensitive to changes in temperature. Too many bends make it heavy and unwieldy.

The tip *n*, drawn out into a coarse capillary, is inserted into a cup of mercury and the whole tube nearly filled with mercury by exhausting the air at the straight end. This may be done conveniently by suction through a rubber tube attached to this end. The mercury should be clean and dry; it is best drawn into the tube when hot. The tube should be heated before filling, and all precautions should be taken to avoid the introduction of bubbles of air or of water vapor. After the tube is filled to a point about 2 centimeters from the blunt end, the arm should be inclined so as to leave the capillary at *n* free from mercury. Now constrict the capillary in the flame at a point very close to the loop until only a very fine lumen remains. Raise the arm, and seal the constricted portion just as the outflowing mercury reaches it. By this method very little, if any, air remains at the tip. Loss of mercury from the open end of the arm may be avoided by temporarily plugging the opening with cotton.

Draw out the end of the arm into a straight capillary about 8 centimeters long and 0.5 to 0.8 millimeter

in outside diameter—the same dimensions as for an isolating pipette, although it is better to have the wall of the capillary slightly thicker (about 45 microns in thickness).

The pipette should now be filled with mercury to a point well within the capillary. This is done by heating the arm at about point *s* (fig. 17) sufficiently to vaporize some of the mercury and expel all air from the capillary. Dip the capillary into mercury, and it will fill as the mercury in the arm condenses and cools. If air bubbles remain in the arm or loop, they may be worked out. Freeing from air is facilitated by heating the arm and sealing the tip while the mercury is vaporized at the point heated. On cooling, a vacuum will be left at the end and the air may be more easily worked out. When the capillary is opened again, it may be necessary to refill it with mercury. The pipette should be as free from air as possible, although a small bubble does not prevent its successful use. Time will be saved by making two or three pipettes at a time. One may be carried through a stage of the process while another is cooling. After they have been finished to the stage described, they may be set aside until a time convenient for use.

When ready for the inoculation, the cells into which substances are to be injected should be placed in a shallow hanging drop near the center of a large cover which is sealed over the isolating chamber, as for ordinary isolation. Sufficient moisture must be supplied. If the cells or filaments are in pure culture, as a fish mold in agar or broth, it is well to have a round or oval paraffin barrier under the cover. This is traced on the cover by means of a coarse bent pipette containing melted paraffin. The fungus may be cultivated within this barrier a day or two before inoculation. The barrier protects against contamination with bacteria.¹⁵ Animals, algæ, or fungi not in pure culture may be placed under the cover with no special precautions. A hanging drop containing the organisms to be inoculated should be put under the cover glass, and near it a hanging drop of sterile water should be placed. These should be as near as possible to the cells to be inoculated. If a paraffin barrier is used, they may be placed just outside of it. Lines should be drawn on the cover, preferably with India ink, to serve as guides to different parts of the preparation. When all is ready, the isolating chamber is placed on the stage and the outer edge brought to focus under the low power.

¹⁵ For a description of the method of cultivating fish molds for inoculation, see *This Journal*, *Sec. B* (1913), 8, 373.

The microburner is placed to the right of the microscope, as usual, and to the right of the microburner and near the edge of the table is placed a large crystallizing dish about 5 centimeters in height, full to the brim with water containing ice. To the left of the microscope is placed a special apparatus for regulating the temperature of the loop.

This apparatus (fig. 18) consists of the brass tube *T*, to the lower part of which is attached the brass cup *C*. This cup is elliptical in horizontal section with a long diameter of about 8 centimeters and a short one of about 4.5 centimeters. The tube *T* is held in the sleeve *S*, which is attached to the arm of a simple microscope provided with a ratchet and pinion *R*. By means of the ratchet and pinion, the sleeve and tube may be raised and lowered through about 5 centimeters. The tube may be raised or lowered in the sleeve; a joint at *J* allows the cup to be swung aside. A Petri dish is placed beneath the cup to receive waste water. The cup must be filled with water containing snow or small pieces of ice.

The pipette is now to be filled with mercury to the tip of the capillary. Heat the loop gently in a flame, and immerse the point of the capillary in mercury the moment all air is expelled. With the tip still in the mercury, immerse about two-thirds of the loop into the crystallizing dish containing ice water and hold it in this position for a quarter of a minute or so. Now remove the tip from the mercury, and immerse the loop still farther into the ice water. The mercury in the capillary will retreat 4 or 5 centimeters from the end. Make the pipette point immediately, following as nearly as possible the same technique as in the case of isolating pipettes. The loop should remain in the ice water, and the arm next to the loop may rest on the edge of the crystallizing dish. The arm should be kept nearly horizontal and held with the right hand at a point near the beginning of the capillary. The forceps, held in the left hand, grasp the capillary. The microburner must be slipped to a convenient distance from the dish. One may draw the pipette more conveniently if seated low enough to bring the eye near the level of the flame.

For this work it is necessary to have a closed tip, coming rather abruptly to a very fine point, *a* (fig. 19). A point more tapering can be used as *b* (fig. 19), but such points are more liable to become clogged with mercury, and do not allow of the control of the dosage as well as the kind illustrated. One will save time eventually by making a point of the proper form. After a suitable tip is drawn, it should be turned at right angles

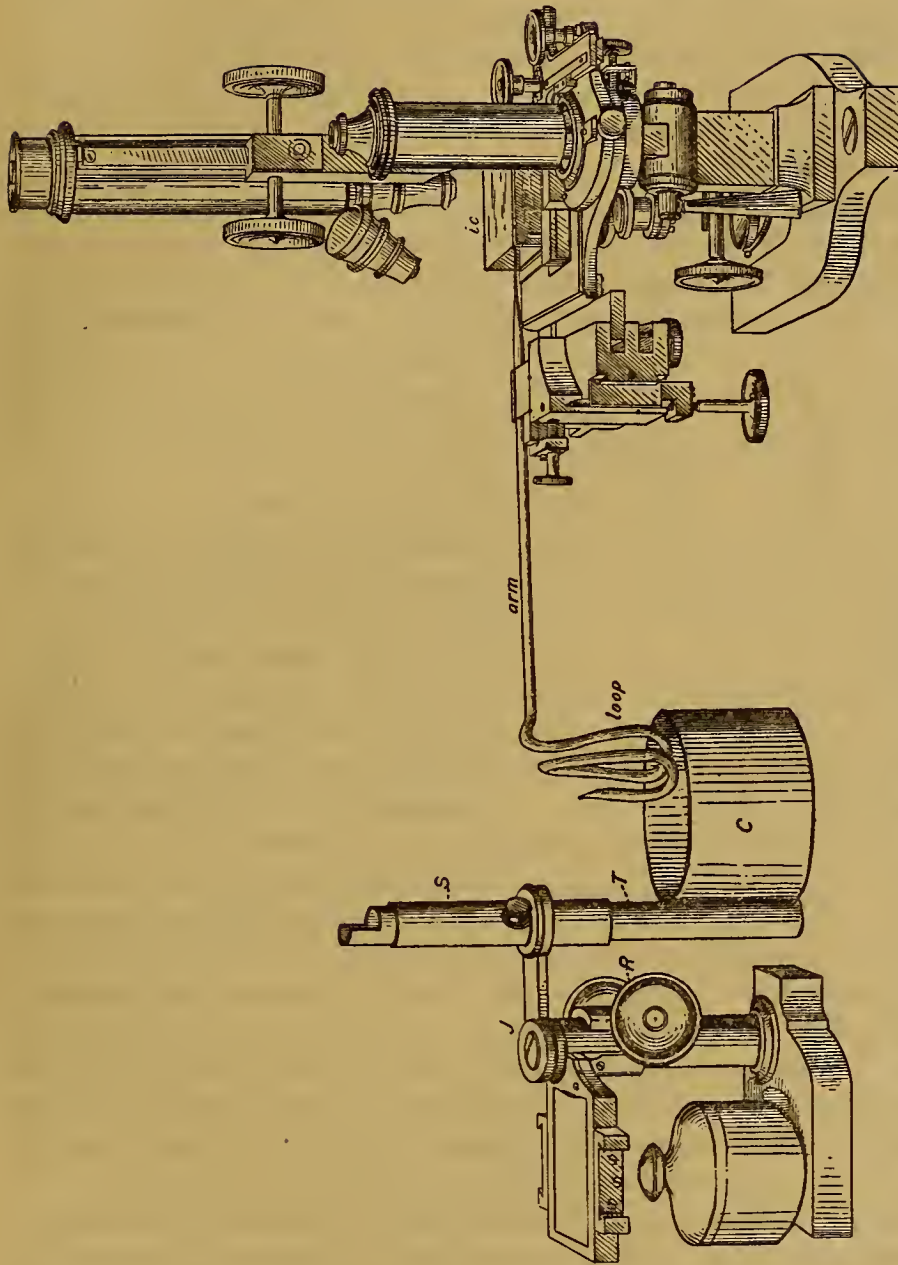

FIG. 18. The inoculation pipette in position with the apparatus for regulating the temperature of the loop. R, ratchet and pinion of a simple microscope; S, sleeve of metal fastened to the lens holder which is jointed to the microscope at J; T, hollow metal tube inserted in the sleeve and bearing at its base the cup C.

or slightly less. Immediately before turning the point, dip the loop wholly in the ice water. Unless there is a partial vacuum in the capillary at the moment of bending, the heated air may expand and burst through the softened glass. One may inspect the point with a hand lens or under the low power before turning it, but the loop should not be left long out of the ice water while the point is still sealed. The pipette is now ready for use and is to be adjusted in the holder. As soon as the tip is brought near the edge of the cover glass, the cup *C* should be brought into place and raised so as to immerse the loop in the ice water. The mercury is under great pressure at room temperature, and may break the pipette if it becomes warm while the tip is still sealed. The final adjustments can be made with the loop in the cup. The cup should be so adjusted in the sleeve that when it

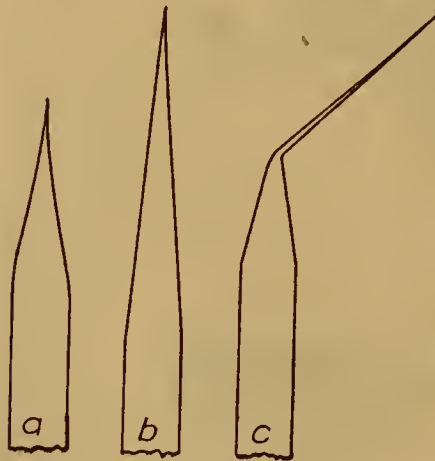

FIG. 19. Various types of tips used in cell injection.

(From *The Journal of Infectious Diseases.*)

during the focusing with the oil immersion. Sometimes it is more convenient to adjust it under the low power just beneath a small droplet of water, or any object easily recognized, and then lower it slightly. The object is then focused under the oil-immersion lens, and the tip is raised into view. The inoculation should be done under high power. An oil-immersion lens of deep focus is by far the best for this work.

The tip, still closed, is now in focus under the high power. The end should be opened by pressing it very gently against the cover and moving the mechanical stage slightly. By varying the pressure on the cover glass, the amount broken off and the size of the opening can be regulated. The size must depend on the substance to be inoculated. If liquids, only the smallest

is racked down to its fullest extent the bottom of the loop will just clear the water in the cup.

The point should now be adjusted to the center of the high-power field. The tip should be broken off under the high power, and great care must be taken to avoid breaking it prematurely. It is best to bring the tip into the hanging drop near its edge, but at a little distance below the cover. If left too near the glass, it may be broken by a slight bending of the cover

possible opening is made; if bacteria, a larger opening is needed; and if yeasts or spores of fungi, one still larger. As a rule, the opening should be as small as the nature of the work will permit. If desired, a point with an opening scarcely exceeding 1 micron in diameter may be made. To determine whether a fine point is open or not, one has only to touch it to a droplet of condensed moisture. If the point is open, the liquid will instantly enter by capillary.

With the tip in the hanging drop of water, lower the cup and allow the mercury to expand sufficiently to expel the air from the pipette. As the pipette was supplied with mercury with the loop partially cooled in ice water, the room temperature will furnish sufficient heat for the expansion of the mercury. When mercury appears at the tip, raise the cup enough to stop the pressure. If some mercury comes out, no harm is done, except when in very tapering pipettes a plug of mercury sometimes clogs the tip. Now bring the tip into the hanging drop of bacteria or other substance to be inoculated. If the mercury column has retreated, apply a little pressure to bring it to the tip again. Raise the cup until sufficient negative pressure has formed to draw in the dose required. The size of the dose can be regulated roughly by the extent of the fall of the mercury column. Then lower the pipette and, as quickly as possible, move to the organism to be inoculated. Bring the tip under it, and raise the point until it penetrates the cell wall and reaches the vacuole or the part of the cell desired. Now apply pressure gradually until the dose is seen to come out and enter the cell. Then stop the pressure at once by raising the cup containing the ice water until it surrounds the loop.

In order that the dosage may be regulated and that mercury may not be driven into the cell, the tip of the pipette should be unobstructed when it pierces the cell wall. Substances may successfully be injected in spite of a clogged tip, but so much force is often required to overcome the obstacle that injection takes place with a rush and mercury is apt to follow the dose. Further, both for the regulation of the dosage and the prevention of clogging, pressure in the pipette should be nearly in equilibrium at the time of the entrance of the point within the cell. Positive pressure may not be a disadvantage if one does not care to avoid ejecting some of the contents of the pipette outside of the cell, but a too strong negative pressure causes the pipette to take up liquid surrounding the cell and increases the danger of clogging when the point enters the protoplasm of the cell.

A clogged pipette may often be opened by gently scratching it on the surface of the cover glass. Sometimes it is necessary to enlarge the opening somewhat before it can be used.

The cup must be well supplied with ice-cold water, and the hand should be on the adjustment *R*, ready to bring it up quickly. In case one is not particular as to the size of the dose, an excess of bacteria may be drawn into the pipette and the pressure stopped when some of the bacteria have come out.

After the dose is in, the pressure is at once diminished and the pipette withdrawn. With very fine tips the point may be drawn out with little or no loss of cell contents. With larger tips it is often necessary to withdraw the tip very slowly until the plug of protoplasm, which usually forms at the point of inoculation, is sufficiently firm to close the opening. In large openings the dose is sometimes drawn back into the pipette on reducing the pressure. Here one may introduce the tip just through the layer of protoplasm and wait until a mound of protoplasm has been formed over it before injecting. This will, in many cases, act as a valve in closing the opening after the dose passes out, so that the tip may be withdrawn safely.

After inoculation, the cover may be removed and placed in a moist chamber or sealed on a hollow slide. If it is desired to keep the substance to be inoculated some distance from the organism, it may be placed on another cover, the dose taken in, the tip lowered, and the covers changed for inoculation.

A filament grown beneath the surface of a hanging drop of agar may be inoculated, but in that case it is well to have the tip nearly at right angles with the capillary, else it may bend too much in entering the agar.

In working with pure cultures, it is sometimes necessary to avoid getting any of the fluid or culture to be injected into the medium outside of the filament. Here, after filling the pipette, it may be quickly washed in a sterile hanging drop of water or agar and then brought to the cell. It is obvious that a tip with a relatively large opening may, if the pressure is negative, draw in the washing fluid or air during transfer, or, if positive, may eject prematurely part or all of the dose. So with such points, it is best to have the pressure as nearly neutral as possible. Fine openings give much less trouble in this respect.

If some bacteria are forced out into the surrounding medium, it is sometimes possible to remove them with an ordinary pipette attached to a rubber tube, such as is used in ordinary isolation. These pipettes, either under or apart from the microscope, may

be used to remove the medium surrounding the infected filament and to substitute any other during the course of an experiment.

If it is found that there is not enough pressure to eject the dose, one may move a Bunsen burner or electric light to a point a few centimeters from the loop. Or a rubber bag containing warm water may be adjusted by means of a bent wire holder to the sleeve of the pressure apparatus, so that the loop in rising will come into contact with it. This is rarely necessary if the loop is cooled sufficiently below room temperature while the capillary is being filled with mercury. The pipette may be so supplied with mercury that it will be under negative pressure at room temperature. In that case, warm water is kept in the cup in place of the cold, and the necessary expansion of the mercury is obtained by immersing the loop in it. But the arrangement first described best meets the main requirement—the possibility of gradually applying pressure and of stopping it quickly.

If a volatile liquid is to be injected, or if large or repeated doses of the same substance are to be used, one may fill part of the capillary with the substance to be inoculated before making the injecting point, but in most cases one can better regulate the dosage by filling from the point. If very small doses are to be injected, one may keep the top of the mercury column in view after supplying it with the dose. The cell is pierced, pressure is applied, and the rising of the mercury column to the tip shows that the dose has come out. Focusing on the mercury column may be facilitated by piercing the cell obliquely with a pipette bent at less than right angles, instead of from directly below. With larger doses, the top of the mercury column is usually below the reach of the lens. Here, one can focus as far down as possible in the lumen of the pipette after its introduction into the cell and stop the pressure on the appearance of the mercury column. If pipettes of the form represented in fig. 19, *a*, are used, much more force is required to expel the mercury than to bring it to the tip, so that one has time to stop the pressure before any mercury can come out. If it is desired to remove cell contents, the retreat of the mercury column indicates that the contents are being drawn into the pipette.

Small doses may be measured by estimating the cubic contents of the pipette between the top of the mercury column and the tip. Larger ones may be estimated by expelling the dose on the cover glass and measuring the droplet expelled by compar-

ing it with one of known volume. (For methods of estimating the size of hanging drops, see page 342.) The liquid is then drawn into the pipette again. If a definite number of bacteria are to be inoculated, they may first be isolated in a droplet of fluid and the whole droplet inoculated.

If the substance to be inoculated forms a precipitate with the mercury, a quantity of water or of some indifferent oil, sufficient to separate the substance to be injected from the mercury, may first be drawn into the pipette.

One should have the cell to be injected well located before filling the pipette and as near to the filling place as possible, so that little time will be lost between charging and injecting. This is the more necessary where it is advisable to keep the pressure in the pipette in equilibrium after filling. Lines may be drawn on the cover glass to serve as guides, the cell may be located by means of the vernier on the mechanical stage, or the droplet of the substance to be injected may be placed just in line with the cell so that only one movement of the mechanical stage is necessary in passing from the one to the other.

The penetration of the plant cells thus far experimented on is easy, if the tip is made fine enough and if the capillary back of it is thick enough to give the pipette the necessary stiffness. If the point of the capillary is too pliable, there may be difficulty in penetrating the cell; if too blunt, there is danger of tearing the cell wall. Sometimes in tough-walled plants there may be some difficulty in piercing the wall without using so much pressure that the pipette, on entering, will penetrate too far. In such cases, one may often obviate the difficulty by pressing the tip against the wall, and then, by moving the mechanical stage gently, bore a hole in the wall.

In the multinuclear cells of the fungus group Saprolegniaceæ and of *Nitella* and *Vaucheria* among the algæ, the cell wall has been pierced, different substances injected, and the pipette withdrawn with little or no apparent injury to the cells, as judged by the movements of the protoplasm and the subsequent behavior of the cell. With some mononuclear algæ cells, as *Spirogyra*, the cell appears to be more sensitive to injury. Few animals have thus far been experimented on with the injection apparatus. Mercury has been injected into rotifers, and other substances have been injected into *Paramecium*. The larvæ of a gnat have been infected with bacteria, and larvæ of *Stegomyia* have been inoculated with defibrinated

human blood. Some work has been done by me on the effect of poisons and other substances injected into the cells of *Nitella*.¹⁶

In making a new capillary point, the pipette may be removed from the holder, the old point broken off, and a new one made from the same capillary. When the capillary is used up, a new one may be made from the end of the straight portion of the pipette, and the process may be continued until all is used back to the loop. If a capillary point remains in good condition after use, the pipette may be removed from the holder and kept for later use; but it must be placed in a refrigerator, else the expanding mercury is apt to burst it.

In certain kinds of work it is of advantage to use two pipettes simultaneously. This makes necessary the use of a second holder for another pipette (fig. 15). With this modification, one may inject two different substances into the same cell at the same time, or by varying the pressure inject with one pipette and withdraw with the other. One pipette may be used simply as a probe or dissecting instrument, or it may be attached to a rubber tube and used as an isolating pipette while the other is arranged for injection. In one experiment, a rotifer was held by the blunted point of one pipette while mercury was injected into the body with the other. Points may be made fine almost to invisibility, with sufficient stiffness for piercing the wall or even the membrane of the nucleus of a cell.

It has seemed to me that this inoculation technique in its different forms may assist in the solution of various problems in the biology of microscopical plants and animals. The introduction of foods, poisons, stains, and fixatives is made possible, and cells may be probed or dissected under high power—methods which may be of use in the study of the structure, chemistry, and physiology of cells. Finally, materials may be withdrawn from one cell and injected into another, and it is possible that investigations on fertilization and heredity may be extended by this technique.

In conclusion, it may be stated that this paper aims to give the principle on which the pipette technique is founded and only a part of its applications in detail. Experienced laboratory workers, especially in fields less familiar to me, may make new applications of the method or changes in the details of those described here. I believe that the method may be much further

¹⁶ *Journ. Infect. Dis.* (1911), 9, 117.

developed in some directions, and may even find some applications in fields other than those of biology. I shall gladly welcome any suggestions as to the improvement of the technique as described here or of its application to other fields of research.

I take pleasure in acknowledging the coöperation of my former students, Dr. A. W. Sellards, Dr. Montrose Burrows, and Dr. Frederick Hecker, in developing this technique. I am also under obligations to Professor E. F. Stimpson, of the physics department of the University of Kansas, and Mr. C. W. White, instrument maker of the University of Kansas, for assistance in working out the mechanical details of the pipette holder.

ILLUSTRATIONS

(Photomicrographs by Charles Martin)

PLATE I

- FIG. 1. Spores of *Aspergillus*. Two isolated and two in one droplet. Freshly isolated and unstained. The amount of condensed moisture proper for isolation is shown in this figure.
2. Spore of *Bacillus subtilis* isolated in a drop of liquid. Freshly isolated and unstained.
 - 3 to 7, inclusive. *Bacterium coli commune*. This series was obtained as follows: One organism was isolated in broth plus a little serum. When it was divided into two, a daughter cell was picked up and transferred to a new droplet. When this had divided, a cell was transferred to a third droplet. After four successive transfers, a series of 5 droplets was obtained containing respectively 1, 2, 4, 8, and 16 bacilli—the offspring of the individuals left behind at each transfer. The cover glass was dried and the bacilli stained on the cover without the loss of a single one from the series. The diameter of the droplets was, on the average, about equal to the length of the chain of 8.

PLATE II

- FIG. 1. Larva of *Culex* injected with mercury by means of the inoculation pipette.
2. Antenna of the larva of *Culex* shown in fig. 1. This was dissected away, and after removal injected with mercury with the inoculation pipette. The point of the pipette was introduced between the spherical and the elongated masses of mercury.

TEXT FIGURES

(Text figures 9 and 19 by courtesy of The Journal of Infectious Diseases. Drawings of other text figures by Moscaira and Espinosa)

- FIG. 1. Pipette holder containing a pipette (*pip*). *cl*, clamp by which the holder is fastened to the metal plate *pb*; *ud*, up-and-down adjustment governed by screw *s*; *rl*, right-and-left adjustment governed by screw *s'*; *g*, groove in which the pipette is held by plate *tp*; *ic*, isolating chamber; *H*, hood of pasteboard for protecting the end of the isolation chamber.
2. Top of pipette holder. *rl*, right-and left adjustment governed by screw *s'*; *g*, groove in which the pipette is held by plate *tp* and set screw *ss*.
 3. Isolating chamber. *p*, lining of blotting paper; *s*, glass strip for retaining water in bottom.
 4. Cover glass marked with cross lines of India ink, and supplied with hanging drops of sterile fluid. *a*, drop to which the bacteria to be isolated are added.

- FIG. 5. Method of making the capillary pipette. *b*, microburner.
6. *a*, completed pipette. *b*, *c*, and *d*, various sorts of points.
 7. A dissecting microscope used as a pipette holder.
 8. A cover glass with droplets arranged for an extended series of isolations. *c*, a droplet shown on a larger scale with a small bacterium-containing droplet beside it.
 9. Two-movement pipette holder, pipette and isolation chamber arranged to illustrate method of transferring single isolated bacteria by means of a perforated mica plate. *ms*, mica plate; *cv*, small cover glass over perforation; *x*, large cover glass; *p*, pipette; *g*, up-and-down adjustment of holder moved by screw *f*; *r*, to-and-fro movement regulated by screw *s*.
 10. A capillary tube in position for taking up isolated organisms.
 11. A pipette constructed for use above a barrier of blotting paper.
 12. Special isolating chamber in longitudinal section. The chamber *b* is closed at the side by the trap *t* and partition *p*.
 13. A special pipette in position for isolating organisms from the bottom of a Petri dish. *p* and *pa*, metal plates screwed to the stage for the attachment of the pipette holder. The complete pipette holder is used, but only a portion of it is shown in the figure.
 14. Special pipette for measuring small quantities of liquid.
 15. Microscope with two pipette holders, each containing a pipette attached to the stage by means of metal plates. Seen from the back. *A*, a three-movement, and *B*, a two-movement holder. *tf*, adjustment, governed by screw *s''*, for moving the pipette to and from the observer. The other letters correspond to those shown in figs. 1 and 2.
 16. Apparatus for attracting certain motile bacteria into pipettes.
 17. Pipette for injecting substances into living cells. Completed.
 18. The inoculation pipette in position with the apparatus for regulating the temperature of the loop. *R*, ratchet and pinion of a simple microscope; *S*, sleeve of metal fastened to the lens holder which is jointed to the microscope at *J*; *T*, hollow metal tube inserted in the sleeve and bearing at its base the cup *C*.
 19. Various types of tips used in cell injection.

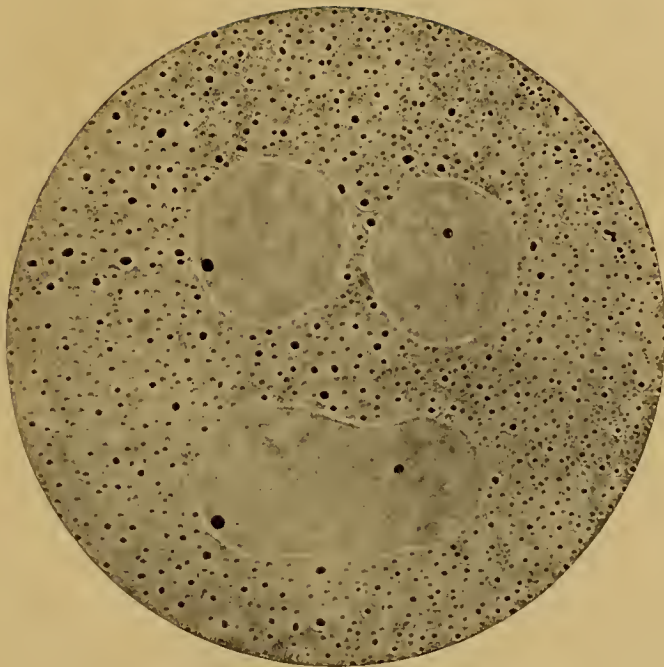

Fig. 1.



Fig. 2.



Fig. 3.



Fig. 4.



Fig. 5.



Fig. 6.



Fig. 7.

Fig. 1. Spores of *Aspergillus*, freshly isolated and unstained. Fig. 2. Spore of *Bacillus subtilis*, freshly isolated and unstained. Figs. 3-7. *Bacterium coli commune*.

PLATE I.



Fig. 1. Larva of *Culex* injected with mercury by means of the inoculation pipette.



Fig. 2. Antenna of the larva of *Culex* shown in Fig. 1.

PLATE II.

NOTES ON THE DIAGNOSIS OF ASIATIC CHOLERA AT AUTOPSY

By B. C. CROWELL

(From the Department of Pathology and Bacteriology, University of the Philippines, and the Biological Laboratory, Bureau of Science, Manila, P. I.)

Without attempting to review the entire pathological anatomy of Asiatic cholera, it may be of advantage to note some facts obtained in our recent experience with 92 cases of the disease, which may be useful in diagnosis at the autopsy table.

The autopsies were performed largely as a diagnostic measure to assist the Bureau of Health in locating cases of the disease. This naturally entailed the examination of a much larger number of bodies than appears in this series. Ninety-one and three-tenths per cent of the series occurred in Filipinos, the remainder occurring in Japanese, Chinese, Americans, and Spaniards. Sixty of the cases were males and 32 females. The ages ranged from 17 days to 99 years, the greatest number occurring between the ages of 21 and 25 years.

The work of the pathologist has gone hand-in-hand with that of the bacteriologist in the recent epidemic, and a loop of small intestine has been submitted to the bacteriologist from every autopsy that has been performed during the period of prevalence of the disease.

As this disease does not exist without the presence of the cholera vibrio, the bacteriologist is naturally considered the court of last appeal in the diagnosis of the disease. In the present series, the number of cases in which there has been disagreement between the pathologist and the bacteriologist were comparatively so few, that these cases have been very instructive, and have served to emphasize certain facts which should be more widely recognized.

The autopsy findings in cases of Asiatic cholera vary according to (1) the stage of the disease at which the patient died, (2) whether or not the patient had received treatment, and (3) the presence of other associated diseases. The disease is notably so severe in its action that a large number of persons previously of great bodily strength and vigor succumb to its influence. On the other hand, cholera is also one of the severe intercurrent in-

fections which ends the life of those who were previously the victims of a more chronic disease. Forty-eight of our cases had no marked evidence of disease other than cholera, while 17 had also lesions of tuberculosis, and smaller numbers had syphilis, marked arteriosclerosis, beriberi, lymphatic leukæmia, strangulated hernia, suppurative hepatitis, Banti's disease, status lymphaticus, bronchopneumonia, and splenomegaly. There were 4 full-term pregnant women in the series, one of whom aborted.

The post-mortem appearances, like the clinical manifestations of the disease, are due to the loss of fluid from the tissues and to the action of the toxin of the cholera vibrio on the tissues. These appearances may be modified by treatment or associated disease.

Rigor mortis.—Rigor mortis appears early, and is stronger than that following any other known disease. The tissues of the hands and feet especially appear shrunken so that the bones and interosseous spaces are prominent. The nails are blue, and the fingers are usually strongly flexed. The soft tissues covering the skeleton feel very dry, and have a doughy consistence. Frequently evidences of the diarrhœa are present about the buttocks. The abdominal muscles are usually rigid, and present the dull, homogeneous, waxy appearance of Zenker's degeneration.

On section the subcutaneous tissues are dry, and the peritoneum and pleura are usually devoid of fluid and are sticky. In no case has the pericardium been devoid of fluid or sticky. In cases that have been treated by the administration of large quantities of fluid, this dryness of the tissues may not be a marked feature. The small intestine is usually somewhat dilated, and presents a dry, sticky, rosy, or pink serosa, sometimes with marked injection of the vessels, standing out in marked contrast to the pallor of the peritoneum covering the large intestine, stomach, and parietes. In other cases the serosa of the small intestine has a slaty gray color. The large intestine is usually contracted. The liver is frequently retracted above the costal margin. The lungs are as a rule poorly inflated, and the pleura is exceedingly dry. In cases which have lost much fluid, the cut surfaces of the lungs are red but very dry, while in the very early cases, or in those which have received fluid, congestion and œdema of the lungs may be marked. The mucosa of the bronchi is usually reddened. Pleural echymoses are not infrequent.

The heart.—The heart presents evidence of degeneration of the muscle and sometimes a dilated right ventricle. The blood within the heart is poorly coagulated and is very dark. This is

true also of the blood in all parts of the body, and its total volume may be very much diminished. In a fair percentage of the cases, however, a mixed coagulum is present in the right side of the heart. No acute endocardial lesions have been encountered. Subendocardial hæmorrhages sometimes occur, while epicardial ecchymoses are the most frequent hæmorrhages found in the body; these are, however, not present in a large proportion of the cases.

The spleen.—The spleen is usually much diminished in size and is flabby, with wrinkled capsule. The cut surface is dry, smooth, and dark red in color.

The kidneys.—The kidneys present either the evidences of an acute parenchymatous degeneration or hæmorrhagic nephritis. In the former case, they are pale and dry and the cortex appears pale, yellowish gray, compact, opaque, and relatively rather wide; the vascular markings in the cortex are not usually readily visible. In the kidneys of the hæmorrhagic type, the organ is more swollen, much darker in color, and the vessels are more prominent, both on the surface and within the organ.

The urinary bladder.—The condition of the urinary bladder is a matter of some interest. In 60 of our cases it was firmly contracted and empty, and 11.6 per cent of these cases had been treated. In 18 cases there was a small amount of urine in the bladder, often only 2 or 3 cubic centimeters, and 77 per cent of these cases had been treated. In the remaining 14 cases no record was kept of the condition of the bladder. I know of no other epidemic disease in which a firmly contracted empty bladder is so constant a finding. The explanation probably lies in (1) the lack of urine, due to (a) loss of fluid through the intestine and (b) specific toxic action on the renal epithelium, and (2) strong cadaveric rigor of the bladder muscle.

The liver.—The liver is diminished in size as a rule, from loss of fluid. It frequently appears dark and congested, probably from concentration of the blood, and presents evidences of acute parenchymatous degeneration from the action of the toxins of the cholera vibrio.

The gall bladder.—The gall bladder may present the condition of hydrops or acute inflammation. This has been very infrequent in our series, only 3 cases of marked inflammation having been recognized.

The stomach.—The stomach frequently contains a moderate amount of brownish fluid; a catarrhal or hæmorrhagic inflammation may be present. In one case a pseudomembranous or gangrenous gastritis was present.

The mesenteric and mesocolic glands usually show no change.

The brain.—The brain usually shows no change other than injection of the meningeal vessels. In about one-third of the brains examined, the note is made that the meninges are dry, while in two cases associated with arteriosclerosis there was pial oedema.

The intestine.—The intestine is the organ about which the greatest interest is centered, but sometimes the findings here are scarcely sufficient to justify a diagnosis without taking the other features into consideration. The condition of the serosa has already been described. The contents of the intestine vary somewhat in character and amount according to the stage of the disease and the amount of fluid which has been administered in treatment. Practically never is any solid or formed fæcal matter present. The usual finding is a smaller or larger amount of fluid, usually pale, with an abundant admixture of mucus and some epithelial flakes. This is sometimes streaked with blood, sometimes deeply bile stained, and sometimes brown in color. In children it may be green. The amount varies from 2 to 3 liters down to a very small amount of mucus without fluid.

The lesion of the intestine itself is essentially an acute catarrhal enteritis. The mucosa, especially of the lower portion of the ileum, appears pale, smooth, glistening, and almost translucent; the lymphoid tissue appears prominent, especially that of the solitary follicles. This same appearance may be present in the colon and stomach. Sometimes the mucosa, especially over and around the lymphoid tissue, appears very red, and occasionally there are actual hæmorrhages in these areas. In 2 cases of the series an actual pseudomembranous enteritis and colitis existed. Without having made definite percentages, I should say that animal parasites were no less frequent than in our usual routine autopsies. The conditions described above may not be very marked, but when taken into account with the findings in other organs usually suffice for a diagnosis. The lack of formed fæcal matter is extremely constant. The difficulty is enhanced when other intestinal diseases are present in the ileum, as for example tuberculosis and status lymphaticus. Even where these coexist, attention to the above features will at least arouse suspicion if not make diagnosis possible.

To recapitulate, it may be said that, while probably no one anatomical feature is constant, the following features are the ones on which a diagnosis is chiefly based:

Acute catarrhal enteritis associated with (1) cyanotic finger nails, (2) dry tissues, (3) oligæmia, (4) dry and sticky peri-

toneum with pink serosa of ileum, (5) contracted and empty urinary bladder, (6) shrunken, dry spleen and liver, (7) acute degeneration of parenchymatous organs, (8) poorly coagulated blood, (9) absence of formed fæces, (10) presence of rice-water intestinal content, and (11) prominence of lymphoid tissue in the ileum.

After all the autopsies performed, we have placed ourselves on record without knowledge of the bacteriological findings except in a very few cases. The cases were classified as (1) cholera, (2) not cholera, (3) probable cholera, or (4) possible cholera. Comparison of the anatomical and bacteriological findings shows that 5 cases anatomically negative were bacteriologically positive. Eleven of the probable cases were bacteriologically positive, while only 1 was negative. Three of the possible cases were positive, while 4 were negative. For a correct interpretation of these findings, it should be borne in mind that the mere presence of cholera vibrios does not mean that the patient was suffering from cholera. In 87 cases there was no difference between the two findings. The cases which were found bacteriologically positive in which the pathologist had committed himself to the diagnosis of not cholera were (1) beriberi, (2) leukæmia and pulmonary tuberculosis, (3) bronchopneumonia and post-mortem decomposition in a 17-day old child, (4) acute peritonitis from strangulated inguinal hernia, and (5) generalized tuberculosis.

The other cases in which the bacteriological findings were negative whereas they had been called probable or possible cholera by the pathologist were cases of acute enteritis, and the suspicion was and is deemed justifiable at a time when cholera is epidemic.

TYPHOID FEVER IN THE PHILIPPINES ¹

By PERPETUO GUTIERREZ

(From the Department of Medicine, University of the Philippines, and the Philippine General Hospital)

During recent years a number of observers have contributed to our knowledge of typhoid fever as it occurs among foreigners in the tropics. Very little work has been published regarding the incidence, clinical types, and mortality of the disease among native inhabitants of warm countries.

The material for this paper is based upon the study of 125 cases of typhoid fever in Filipinos, treated in the Philippine General Hospital during a period of a little less than two years. During this time, there were 137 cases of typhoid admitted to the hospital, of which 6 were Americans, 3 Portuguese, 1 English, 2 Japanese, and the remainder Filipinos.

The importance of recognizing the incidence index of typhoid fever in this country cannot be overestimated, because once this infection gains a foothold it will be difficult to eradicate, on account of the peculiar environment and the poor hygienic condition under which most of the people live.

There seems to be considerable difference of opinion regarding the local distribution and prevalence of the disease. Chamberlain, Nichols, La Garde, and others believe it to be prevalent throughout the Archipelago. Heiser, on the other hand, claims that the incidence was very low prior to 1910. Whether or not the disease is on the increase, I am not in a position to say. Certainly more cases came to the hospital this year than in previous years. In 1911 there were 23 cases, or 0.66 per cent, of typhoid out of a total of 3,461 admissions. During the fiscal year 1912 there were 39 cases, or 0.53 per cent, of typhoid patients out of a total of 7,252 admissions. During these two years, therefore, the number of typhoid patients admitted shows a fairly uniform relationship to the total admissions. Beginning with the fiscal year 1913 and up to the present time, there have been 98 cases of typhoid out of a total of 6,300 admissions. This marked increase may be due, in part, to the fact that people are getting more used to hospitalization, but this cannot explain all the factors concerned in the increase, and if we may draw conclusions from the statistics of the hospital typhoid fever is more prevalent now than it was during previous years.

¹ Read at the meeting of the Colegio Médico-Farmacéutico de Filipinas, June 21, 1913.

Seasonal incidence is a characteristic of typhoid in Europe and the United States where the greatest prevalence is seen during the autumn months, continuing into the winter, and declining during the spring months. Examination of the following table indicates the same seasonal distribution in this country that is encountered in temperate climates. However, the variation is not so marked and the series of cases is too small to justify definite conclusion.

TABLE I.—Seasonal incidence of typhoid in the Philippine Islands.

Month.	Number of cases.		Total.
	1912.	1913. ^a	
January	1	9	29
February	3	7	
March	4	5	
April	5	6	31
May	7	8	
June	2	3	
July	6	6	33
August	2	8	
September		11	
October	2	15	44
November	2	11	
December	5	9	
Total	39	98	137

^a Figures for the fiscal year 1913 are incomplete. The last case in this series was on May 28.

Sex.—The sex incidence of 85 males and 40 females out of a total of 125 cases corresponds closely enough with sex statistics of this disease in other countries.

Age.—The distribution of the disease by ages is shown in the following table.

TABLE II.—Age incidence of typhoid in the Philippines.

	Age.						Total.
	10 years.	11 to 14 years.	15 to 25 years.	26 to 30 years.	31 to 40 years.	Over 41 years.	
Males	3	4	53	13	10	2	85
Females	2	3	29	3	2	1	40
Total	12		82	28		3	125
Percentage	9.6		65.6	22.4		2.4	
Rogers	41.6		47.23	11.1			
Curschmann:							
Hamburg	11.02		48.68	30.3			
Leipsic	9.59		49.40	40.01			
Osler	7.73		46.69	45.58			

Rogers calls attention to the frequency of typhoid in children in India. In his Calcutta series 41.67 per cent of his cases occurred in patients under 15 years of age. Manson also calls attention to the frequency of typhoid among oriental children, but Nichols, writing from the Philippines, states that only 9.6 per cent of the total cases occurred in patients under 15 years of age. In examining the table, it is seen that the percentage of infection, according to ages, in my series corresponds fairly well with statistics from other countries.

CLINICAL DESCRIPTION

The following discussion of the clinical picture of typhoid as seen in this country is based on the study of 125 cases treated during a period of a little less than two years. Diagnoses of about 90 per cent of these cases were verified by blood culture or serum reaction. Of the remaining cases the diagnosis was based upon the course of the disease, the fever, low leucocyte count, enlarged spleen, etc., and in some of these the diagnosis was verified by autopsy. It is fully realized that the number of cases studied is too small to justify conclusions regarding the incidence of rare complications, but the evidence seems to be useful in analyzing the most important features of the disease as it is seen in the Philippine Islands.

The disease, in a general way, presents essentially the same symptoms in the tropics that it does in the temperate climates; yet there are a few exceptions which stand out prominently before the clinician. The mortality seems to be higher while the fever is lower, and the duration of the fever at first sight would seem much shorter than that encountered in other countries. The temperature curve is less frequently characteristic than it is in the temperate climates.

The course and type of temperature.—The typical typhoid temperature of the temperate climates is divided into three stages: the steplike rise at the outset, the evening temperature always higher than that of the evening before, which lasts for a period of from three to five days, after which the stage of continued fever or fastigium is recognized. During this period the temperature ranges from 39°.5 to 40°.5 C. with but very slight remissions. This stage lasts from a few days to three or four weeks, and ushers in the third stage, or the stage of decline, during which the remissions become more and more marked until the normal is reached. This typical temperature in typhoid is very seldom encountered in the Philippine Islands. Indeed, such a classical temperature curve is so rare that when

it does occur it is considered to be of grave importance in prognosis as well as in elucidating the diagnosis. In most of our cases we have come to rely more upon the relation between temperature and pulse in making a diagnosis than upon the temperature itself.

The onset of the fever usually is so irregular that the suggestion of the possibility of typhoid does not occur until the disease is well advanced. The most frequent symptoms during this period in the series of cases under discussion were headache, 96; general pain all over the body, 25; chilly sensation, 29; malaise, 24; abdominal pain, 22; pain in the right iliac region, 3; epistaxis, 1. Headache is the most constant of all symptoms, often intense and frequently lasting well into the second week of the disease. Very frequently the patients state that the onset was sudden, preceded by a chill, and followed by fever. It sometimes subsided to recur again after a few days' intermission. In certain instances there is a sudden chill, followed by high continuous fever from the onset. The period of rising temperature could not be ascertained with accuracy in most cases, because most patients were admitted to the hospital during the second week of the disease or later.

Fastigium.—The stage of continued fever is not so prolonged nor the fever as high as is usually described for this stage. Out of 115 cases in which the temperature was studied carefully, only 8 showed a temperature over 40, and in only one case did the temperature reach 41. In Osler's 1,118 cases, 67.48 per cent showed a temperature above 40, while in my series 43.4 showed a maximum temperature of 40 degrees. Osler quotes 25 per cent remaining below 40, whereas 44.34 per cent in the present series remained below this point. Another important deviation during this stage is the marked remission of temperature in the Manila cases, a condition which was noted in 24.34 per cent. This discussion is illustrated by Table III.

TABLE III.—*Temperature during the fastigium.*

Number of cases.	Temperature.	Percentage.
8.....	40° C.....	6.95
42.....	40° C. or below.....	36.52
54.....	38° to 39-50°.....	44.34
11.....	Irregular.....	9.56

Stage of decline.—The fever in my series lasted on an average of thirty days. It began to show marked remissions and declines

at about the end of the third week. The temperature usually reached normal in about seven days, but in some cases the stage of decline was more prolonged and the temperature did not entirely subside until the eighth to the thirteenth day. However, in no instances was the stage of decline as prolonged as the maximum given by Rogers.

Recrudescence and relapse.—Manson in describing his experience with typhoid in China says, "Not only is the tropical form grave from the outset, but extremely liable to relapse." In the Manila series there were 6 cases of recrudescence, or 4.3 per cent, and 11 cases actually relapsed, or 8.02 per cent. In only one of these cases did the temperature relapse more than once. This patient is just recovering from the third attack at the time of writing.

Irregular temperature.—Of the 115 cases in which the temperature was studied, in 11 cases, or 9.56 per cent, the temperature was exceedingly irregular. The fever presented many different phases, not one feature being constant. The temperature may be 39° or 40° for two or three days, and then quickly drop to 38° or 37°.5; or it may even drop to normal for two or three days, only to rise again to its former height. In one case the temperature was as low as 38° for a number of days and then became normal; this period in turn was followed by an intermittent type of 39° or more in the afternoons and normal in the morning. In this case, after thirteen days, the serum reaction was positive and culture of the urine showed typhoid bacilli at four different intervals after convalescence, finally becoming negative on the eighteenth day.

Rigors.—Actual chills as described by Rogers were present in only 2.91 per cent of my cases. In two of these cases the rigors were caused by an intercurrent malaria, but the actual cause in the others could not be ascertained.

Abortive cases.—There were 19 cases, or 13.86 per cent, in which the duration of the fever varied from five to fifteen days, or an average of eleven days from the onset, until the temperature became normal. During this period the temperature varied from 38° to 39° C., rarely reaching the latter figure. The onset may be a typical steplike rise as is seen in classical cases of the disease. It may then become continuous for from two to five days, and then marked remissions appear and the temperature reach normal in a few days. These cases are interesting clinically as well as epidemiologically, because of obscurity of the diagnosis which rarely would be made outside of a hospital. Undoubtedly many such cases go through the course of the disease without being

diagnosed as typhoid fever, especially as there are many fevers in the tropics of obscure etiology. These irregular types frequently are diagnosed as malaria or "fiebre continua."

In view of the above findings, there are a few diagnostic points that the clinician should constantly bear in mind when dealing with fever patients. In irregular types of typhoid the usual headache is generally present, sometimes intense but most frequently a dull ache is complained of at the top of the head. The relation of the fever to the pulse is maintained. A continued temperature of 39° C. with a pulse of 90 or 80 per minute is rather suspicious when noted in connection with the other above-mentioned symptoms. The spleen was enlarged at least to percussion in nearly all of these cases, and the typhoid tongue was present in all except the mildest cases. The serum reaction usually and blood culture almost invariably will, of course, confirm the diagnosis. Therefore, in the tropics when we see a case of continuous or even intermittent fever with slow pulse, headache, and an enlarged spleen, we should be suspicious of its being typhoid, even though the fever is not high and the duration not as long as we expect to see in typhoid. The diagnosis in many of these cases is difficult or impossible except by laboratory methods. Twelve of the cases in this series probably would not have been diagnosed outside of a hospital, where blood culture is routine in all doubtful fevers.

Recently we have had a small epidemic of 12 cases of typhoid among the students in one of the Government dormitories in Manila. In all of these patients the disease was of short duration with an atypical fever, and other features of the disease were so irregular that the disease would not have been recognized except by blood cultures.

The recognition of these atypical cases of typhoid is of particular interest to public-health officials. An epidemic similar to the one mentioned above occurring in a country town, or other remote district, is liable to cause a great deal of trouble before the nature of the illness is recognized. This is particularly true in this country because the sanitary conditions are of the most primitive character. Frequently, there is no sewer system and the excreta is disposed of as the family sees fit. The usual method is to allow pigs and other scavengers to take care of it. Flies usually are abundant throughout the year, and the infective material is freely accessible to them. Clothes and utensils are never boiled, and the people around the patient probably eat with their fingers without so much as washing their hands with soap and water.

ANALYSIS OF SYMPTOMS

General appearance.—In frank cases, except in the mildest, the typhoid clinical picture is present. “Flushed faces” were noted in 51 cases, typhoid tongue was noted in 108, typhoid facies in 81, typhoid state in 25, bleeding from the gums and lips was found in but 8 cases, and “rose spots” were found in 26 cases, although they were not especially looked for. It has been a common belief among practitioners about Manila that rose spots are rare in typhoid among Filipinos. I have not been able to find any evidence to justify this conclusion. If rose spots are not especially searched for, they will be overlooked oftener in the dark-skinned race than will be the case in fair-skinned patients. In the last 15 cases of this series, rose spots were searched for with care, with the result that they were found in 11, or 73.66 per cent, of the patients.

Delirium probably is not as prevalent as it is in temperate climates. It was present in 19 of my cases, or 13.86 per cent. Seven cases were of the low-muttering type, and 12 patients had wild delirium. The lowered incidence of delirium is probably due to the unusually low fever encountered in many of our patients. “Typhoid state” was present in only 18.24 per cent of this series.

The circulatory system.—The heart presented the usual toxic effect of this disease, and no peculiar conditions were noted. The usual pulse found in typhoid fever was encountered in this series. The rate was disproportionately low as compared with the fever, and was one of the important symptoms that was looked for, especially when the fever was irregular.

TABLE IV.—Pulse rate in typhoid.

	Pulse not over 100 throughout high temperature.		Pulse not over 100 for two or more days.		Pulse not over 100 throughout fever.	
	Number.	Per cent.	Number.	Per cent.	Number.	Per cent.
Males	47	55.95	24	28.57	13	15.47
Females	16	35.71	10	35.70	8	28.35
Children			3	23.07	10	76.92
Rogers:						
Males	22	36.06	26	33.30	18	30.00
Females			2	11.10	16	88.90
Children					27	100.00

The spleen.—Probably next in importance to the pulse rate comes the spleen. Of 118 cases, the spleen index was recorded in 31. In 16 it was enlarged 2 centimeters or more below the

arch; in 11 cases it was enlarged to percussion; in 4 cases it was not enlarged at all; and in 14 cases it was not mentioned. Only one case showed an enlargement of 10 centimeters below the costal arch. The diagnostic significance of enlargement of the spleen is greatly reduced in the tropics, on account of the many diseases giving rise to an enlargement of this organ. However, when viewed in connection with the other symptoms, it has some value in this respect.

The respiratory system.—The lungs showed the usual complications encountered in this disease. Bronchitis was found in 55 cases. Pneumonic consolidation was noted in 13 cases and tuberculosis in 6 cases. In two of the tubercular patients a latent infection was probably excited by the typhoid, because the patients showed no active lesions of tuberculosis at the time of entrance.

The digestive system.—The typhoid tongue was fairly constant, being present in 108, or 78.83 per cent. Tympanitis has not been so marked as to cause alarm; in only one was it a very severe symptom. The bowels were more often constipated than loose. There were 9 cases that showed diarrhœa throughout the disease, making 6.56 per cent of the cases, and 21 cases, or 15.36 per cent, had transient diarrhœa. The rest were constipated throughout the course of the illness.

Intestinal hæmorrhage.—This complication occurred in 21 cases, or 15.23 per cent of the series. In one patient with hæmorrhage, diarrhœa persisted throughout the course of the disease, while two other cases showed transient diarrhœa, thus making a total of 3 cases which showed diarrhœa, or 13.33 per cent of patients with hæmorrhage associated with diarrhœa in the same person. In 8 cases with hæmorrhage, or 38.14 per cent, special attention was called to the severity of the disease. Out of the 21 cases with hæmorrhage, 11 lived and 10 terminated fatally.

Intestinal perforation.—Probably next in frequency to hæmorrhage is perforation. In this series there were 10 patients who had perforation, or 7.29 per cent of the total cases. This figure probably is higher than the normal percentage of perforations in the Philippines, because frequently only the most severe cases, or those with complications, are sent to the hospital. Three cases in this series had general peritonitis when they were admitted.

Malarial incidence.—Intermittent malarial infection was found four times in this series. In one, the fever was ushered in with chills and the malaria was not discovered until its re-

appearance during convalescence from the typhoid. In one of the four cases malarial symptoms predominated. In two cases the stage of fastigium was somewhat irregular, the temperature varying greatly. Repeated doses of quinine, both intravenously and by mouth, made the temperature more regular, but otherwise failed to modify the course of the disease. The double infection was verified by blood examination in each case.

Other complications.—Periostitis was found in 5 cases, thrombosis of the left femoral in 1, and typhoid spine in 1. Post-typhoid psychosis or mania was encountered three times, but all of the patients affected recovered. Peripheral neuritis was encountered in a number of cases, but the total number could not be ascertained as they were not recorded in every case.

Mortality.—Osler gives 7.5 per cent as the mortality rate in his Baltimore series. However, he states that the death rate varies from 5 to 12 in private practice and from 7.03 to 12 per cent in hospital practice. Curschmann places it at 12.7 per cent, and Rogers at 16.3, for white troops in the tropics and at 26 per cent for the Indians. When we come to the Philippines we find Chamberlain placing it at 17.65 per cent for the Filipinos, while 16.8 per cent was the figure set for Americans. In this series there were 20 deaths, or about 20.43 per cent. Upon closer examination it was found that about half of these cases were admitted in a dying condition, or, if not actually dying, they were in a hopeless condition. There were as follows: three cases with general peritonitis; 4 patients lived only two or three days after admission; 3 were admitted from the twenty-third to the sixtieth day of the disease; and another 3 cases came in after the fifteenth day of the disease. Excluding 10 cases which certainly were hopeless from the time they came in, we have a mortality of 13.13 per cent. This is certainly a high percentage of mortality, but it compares favorably with those cases of Rogers, Chamberlain, and Curschmann. Outside of the delayed hospitalization, a serious handicap is the generally poorly nourished condition among most of the Filipinos. The class of patients dealt with in this article are mostly from the poorer class, many of whom cannot afford the services of an outside physician, so that alimentation and intestinal disorders are wholly neglected.

Laboratory method of diagnosis.—There does not appear to be any unusual disturbance of the blood picture. From a diagnostic standpoint the leucocyte count is interesting, and it is especially so in the tropics because of the increased difficulties of diagnosis.

The number of leucocytes in the various cases in this series was as follows:

TABLE V.—Cases with leucocytes.

Leucocytes.		Cases.
From 2,000 to	3,000	3
	3,000 4,000	12
	4,000 5,000	19
	5,000 6,000	27
	6,000 7,000	18
	7,000 8,000	16
	8,000 9,000	8
	9,000 10,000	9
	10,000 13,000	7

Of twenty differential counts made, there was a decrease to 59.8 per cent of the polymorphonuclears, while in about 50 per cent of these cases the lymphocytes exceeded 30 per cent. Large mononuclears were 3.7; transitionals, 4 per cent; and eosinophiles, 1.65 per cent. The hæmoglobin estimation had an average of 84 per cent by the Tallqvist method.

Serum reactions were made 247 times, the dilutions being 1–40, the time one hour. Olsner considers this an almost specific diagnostic method for typhoid; certainly for routine methods it serves the purpose. During the fiscal year 1912, laboratory facilities were limited and frequently only one reaction was obtained. During that year 37 out of 47, or 78.72 per cent of the suspected cases, gave a positive reaction. During the fiscal year 1913, the agglutination test was made more frequently and several tests were often made on the same patient, particularly when a negative report was received with suggestive clinical findings.

TABLE VI.—Serum reaction.

Period of disease.	Year.	Negative, $\frac{1}{10}$.			Positive, $\frac{1}{10}$.			Positive, $\frac{1}{20}$.			Total retested.	Total reacted.	Percentage.
		Total.	Retested.	Reacted.	Total.	Retested.	Reacted.	Total.	Retested.	Reacted.			
First week	1912	1			1						2	1	50.00
	1913	8	7	7	10	4	3	9	3	2	27	19	37.00
Second week	1912	7	6	4	14			9			30	23	76.66
	1913	5	3	2	53	4	4	50	4	4	108	103	95.37
Third week	1912	2			10			3			15	13	86.66
	1913	1	1		32	2	2	32	2	2	65	64	98.43
Total	1912	10	6	4	25			12			47	37	78.72
	1913	14	11	9	95	10	9	91	9	8	200	186	93.00
Grand total		24	17	13	120	10	9	103	9	8	247	223	90.28
Rogers		31	22	20	10	1	1	24	2	2	150	119	79.30

Blood cultures were not taken in all of these cases, owing to the patients coming to the hospital late in the course of the disease. However, 45 blood cultures were taken by Dr. E. H. Ruediger of the Bureau of Science, and of the 13 cases in which the blood was taken during the first six days of the disease 8 cases, or 61.53 per cent, were positive for *Bacillus typhosus*. After the sixth day of the disease there were 32 blood cultures taken with 12 positive findings, or 37.5 per cent.

SUMMARY

1. The age incidence of typhoid fever as seen in the Philippine General Hospital corresponds with that of other countries, but is not so high as claimed by Rogers, Manson, and Nichols.

2. The fever course of the disease is essentially the same as in the United States and in Germany, but the temperature is much lower and the stage of fastigium is not as typical.

3. Relapses occur about as frequently as in other countries.

4. Abortive cases are rather common and often difficult to diagnose. Every continued fever with slow pulse and enlarged spleen should have a serum reaction and other confirmatory tests. Blood culture should be employed in all cases of doubt.

5. Delirium and the typhoid state are not so common as in other countries. This is probably due to the lower temperature in typhoid in the Philippines.

6. Intestinal hæmorrhage occurred in 15.23 per cent of all cases. I am unable to ascertain the cause of such a large number. It may be due to neglect of the gastrointestinal canal consequent to delay in receiving medical attention.

7. Perforation is also common, for which no special cause can be attributed.

8. The mortality on superficial examination seems to be high, but after eliminating these cases that came to the hospital in a dying or hopeless condition we obtain a more normal death rate. The further slightly higher percentage of death rate may be due to the lower resistance of the Filipinos consequent to their modes of life, undevelopment, and limited diet.

Since this paper was written, the number of intestinal hæmorrhages and mortality has been decreased, because the cases were admitted to the hospital earlier in the course of the disease and the diet of the people in general has been improved.

In conclusion I wish to express my sincere gratitude to Dr. W. E. Musgrave for his interest in the course of the preparation of this article and to Dr. L. Gomez for his suggestions.

REFERENCES

- BRUNS, EARL H. *Milit. Surgeon* (1908), 22, 369.
- CASTELLANI, A., and CHALMERS, A. J. *Tropical Medicine*. Wm. Woodcock & Co., N. Y. (1910).
- CHAMBERLAIN, W. P. *Phil. Journ. Sci., Sec. B* (1911), 6, 299.
- CHAMBERLAIN, W. P., and BLOOMBERGH, H. D. *Milit. Surgeon* (1910), 27, 529.
- Editorial. *Ibid* (1910), 26, 586.
- EDWARDS, ARTHUR R. *Principles and Practice of Medicine*. Lea Febriger, N. Y. (1909).
- GOODHUE, E. S. *Am. Journ. Pub. Hlth.* (1912) 2, 883-895.
- HEISER, V. G. *Phil. Journ. Sci., Sec. B* (1910), 5, 171.
- JACKSON, T. W. *Med. Rec.* (1912), 76, 511.
- LA GARDE, L. A. *Milit. Surgeon* (1908), 22, 373.
- MANSON, P. *Tropical Diseases*. Wm. Woodcock & Co., New York (1911).
- NICHOLS, H. J. *Milit. Surgeon* (1909), 22, 365.
- OSLER'S *Modern Medicine*. Lea Brothers & Co., Philadelphia and New York (1907), 2.
- PHALEN, J. H., and KILBOURNE, E. D. *Milit. Surgeon* (1910), 27, 56.
- ROGERS, L. *Fevers in the tropics* (1910), 110-148.

REVIEWS

**Biochemic Drug Assay | Methods | with special reference to the phar- | maco-
dynamic standardization of drugs | by | Paul S. Pittenger, Ph. G.,
Ph. C., Phar. D. | instructor [etc. 5 lines] | edited by F. E. Stewart,
M. D., Ph. G. | professor [etc. 7 lines] | Philadelphia | P. Blakiston's
Son & Co. | 1012 Walnut Street | Cloth, pp. i-xiv + 1-158. 89 illustra-
tions and diagrams. Price \$1.50 net.**

The book is not exactly what the title—A Manual of Biochemic Drug Assay Methods—would lead one to believe as the author has included only those methods of drug assaying which are physiological in nature. Although it represents the first attempt at preparing a manual of this sort, it contains very little that is original in material or in the arrangement thereof.

The contents of the book are grouped into eight chapters; chapter I is headed Preliminary Considerations and deals primarily with the factors making drug assaying desirable; chapters II to VI, inclusive, are devoted to descriptions of the more important physiological assay methods and their application to the standardization of the cardiac stimulants and depressants, epinephrine and products of the suprarenal gland, ergot, pituitary extracts, and cannabis indica; chapter VII contains descriptions of apparatus and technique employed in conducting the assays described in previous chapters; and chapter VIII gives directions for preparing a few of the stock solutions commonly used in work of this nature.

As stated in the preface, the manual is intended for students of pharmacy, students of medicine, and experts engaged in drug standardization work. With respect to students in pharmacy, the author presupposes such students to have a very considerable knowledge of animal anatomy and practical physiology. Until such studies are made a part of the curriculum of the schools or colleges of pharmacy, the manual will be beyond the ordinary student of pharmacy. To the student of medicine who is accustomed to the use of a textbook on pharmacology, such as that of Cushny or of Sollman, the manual will seem elementary indeed and will be found of little value. It should, however, be of some service to experts engaged in the standardization of drugs or to those who desire a general knowledge of the physiological methods employed in the standardization of drugs without the trouble of consulting the larger works on pharmacology or of looking up the original references.

A. G. DUMEZ.

Beriberi | by | Edward B. Vedder, A. M., M. D. | Captain Medical Corps, U. S. Army. Member of the United States Army Board | for the Study of Tropical Diseases as They Exist in the Philippines, | December, 1910, to April, 1913. | [dash] | The Cartwright Prize of the Alumni of the College of Physicians and Surgeons, | Medical Department of Columbia University, New York for 1913, and | published by permission of the Surgeon-General of U. S. Army. | [dash] | Illustrated by Numerous Engravings | and by Five Colored Plates | [dash] | New York | William Wood and Company | MDCCCXIII. Cloth, pp. i-viii + 1-427.

This book is the most extensive treatise on beriberi in the English language, and appears at a time when not only all medical scientists but also the lawmakers in several countries are interested in the subject. Vedder has had very favorable opportunity for carrying on investigations of the etiology of beriberi and its cure. As a member of the United States Army Board for the Study of Tropical Diseases as They Exist in the Philippines, his experience in Manila made it possible for him to see many cases of the disease and to prove the value of the extract of rice polishings prepared by Chamberlain and Vedder. The book deals with the history and the clinical and pathological aspects of the disease, especial emphasis being placed on the etiology. His conclusions that avian polyneuritis is the same disease as human beriberi and that beriberi is caused by a too exclusive diet of polished rice or by any other diet lacking in the vitamins which are necessary for normal metabolism are now accepted by the majority of workers on the subject, and Vedder's review of the work of himself and others is presented in a very pleasant and convincing manner. The abundant illustrations are excellent, and the book is presented in Wm. Wood & Co.'s usual good form.

B. C. C.

The Mechanistic Principle and | the Non-Mechanical | an inquiry into fundamentals with extracts from | representatives of either side | by | Paul Carus | Chicago | The Open Court Publishing Company | 1913 | Cloth, pp. i-iv + 1-125.

Memory | lectures on the specific energies | of the nervous system | by | Prof. Ewald Hering | University of Leipzig | fourth edition, enlarged | 1913 | The Open Court Publishing Company | Chicago London | Cloth, pp. 1-70.

PUBLICATIONS FOR SALE BY THE BUREAU OF SCIENCE,
MANILA, PHILIPPINE ISLANDS—Continued

BOTANY

A FLORA OF MANILA

By ELMER D. MERRILL

Order No. 419. Paper, 490 pages, \$2.50, postpaid.

Practically a complete flora of the cultivated areas in the Philippines. Descriptions, with keys, of over 1,000 species, 590 genera and 136 families, with native names, glossary of technical terms, etc.

THE COCONUT PALM IN THE PHILIPPINE ISLANDS

Order No. 37. Paper, 149 pages, 30 plates, \$1, postpaid.

The reprint contains the following articles: On the Water Relations of the Coconut Palm (*Cocos nucifera*), The Coconut and its Products to Coconut Oil, The Keeping Qualities of Coconut Oil and the Causes of its Rancidity, and The Principal Insects Attacking the Coconut Palm.

INDO-MALAYAN WOODS

By JOHN W. FOXWORTHY

Order No. 411. Paper, 122 pages, 9 plates, \$0.50, postpaid.

In the Indo-Malayan Woods, Doctor Foxworthy has brought together a large amount of accurate information concerning trees and the woods of Indian value.

ZOOLOGY

A LIST OF THE MAMMALS OF THE PHILIPPINE ISLANDS, EXCLUSIVE OF THE CETACEA

By JOHN HALLGREN

Order No. 418. Paper, 64 pages, \$0.50 postpaid.

This is the only recent attempt to enumerate the mammals of the Philippine Islands. The distribution of each species is given, and the original descriptions are cited.

ZOOLOGY—Continued

A MANUAL OF PHILIPPINE BIRDS

By RICHARD C. MCGREGOR

Order No. 103. Paper, 2 parts, 769 pages, \$4, postpaid.

A Manual of Philippine Birds contains in compact form descriptions of all the known species of Philippine birds. The usual keys and diagnoses of orders, families, and genera help the novice in identification.

A CHECK-LIST OF PHILIPPINE FISHES

By DAVID STAER JORDAN and ROBERT EARL RICHARDSON

Order No. 102. Paper, 78 pages, \$0.75, postpaid.

This list will be found a convenient guide to the synonymy of Philippine ichthyology. The nomenclature is thoroughly revised, and the distribution of each species within the Philippine Islands is given.

MEDICINE

REPORT OF THE INTERNATIONAL PLAGUE CONFERENCE

Held at Manila, April 1911, under the auspices of the Philippine Government.

Edited by EDUARD MARTINI, G. F. PERRIE, ARTHUR STANLEY, and RICHARD P. STRONG

483 pages, 15 plates (2 colored, 4 half-tones, 12 charts and maps)

Order No. 416. Paper, \$2.50; cloth, \$3.50; postpaid.

The proceedings of this International Conference and information gained therefrom, together with the results of certain bacteriological investigations, constitute the present report.

The Bureau of Science of the Government of the Philippine Islands has been appointed sole agent for the distribution of the printed proceedings of the International Plague Conference.

PRICES ARE IN UNITED STATES CURRENCY

Orders for these publications may be sent to the BUSINESS MANAGER, PHILIPPINE JOURNAL OF SCIENCE, BUREAU OF SCIENCE, MANILA, P. I., or to any of the agents listed below. Please give order number.

The Macmillan Company, 64-66 Fifth Avenue, New York, U. S. A.
Wm. Wesley & Son, 28 Essex Street, Strand, London, W. C., England.
Martinus Nijhoff, Lange Voorhout 9, The Hague, Holland.
Mayer & Müller, Prinz Louis Ferdinandstrasse 2, Berlin, N. W., Germany.
Kelly & Walsh, Ltd., 32 Raffles Place, Singapore, Straits Settlements.
A. M. & J. Ferguson, 19 Baillie Street, Colombo, Ceylon.
Thacker, Spink & Co., P. O. Box 54, Calcutta, India.

VOL. IX, SEC. B, No. 5.

SEPTEMBER, 1914

THE PHILIPPINE JOURNAL OF SCIENCE

ALVIN J. COX, M. A., PH. D.

GENERAL EDITOR

SECTION B

TROPICAL MEDICINE

EDITED WITH THE COÖPERATION OF

E. L. WALKER, S. D.; M. A. BARBER, PH. D.; A. R. WARD, D. V. M.
Committee on Experimental Medicine

V. G. HEISER, M. D.; W. E. MUSGRAVE, M. D.; B. C. CROWELL, M. D.
Committee on Clinical Medicine

R. C. MCGREGOR, A. B.

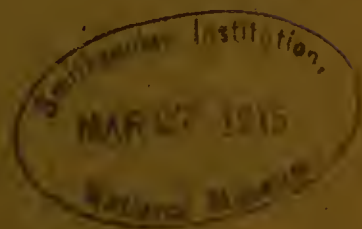

MANILA
BUREAU OF PRINTING
1914

PUBLICATIONS FOR SALE BY THE BUREAU OF SCIENCE,
MANILA, PHILIPPINE ISLANDS

ETHNOLOGY

A VOCABULARY OF THE IGOROT LANGUAGE AS SPOKEN BY THE BONTOC IGOROTS

By WALTER CLAYTON CLAPP

Order No. 403. Paper, 89 pages, \$0.75, postpaid.

The vocabulary is given in Igorot-English and English-Igorot.

THE NABALOI DIALECT

By OTTO SCHEERER

and

THE BATAKS OF PALAWAN

By EDWARD Y. MILLER

Order No. 403. Paper, \$0.25; half morocco, \$0.75; postpaid.

The Nabaloi Dialect (65 pages, 29 plates) and the Bataks of Palawan (7 pages, 6 plates) are bound under one cover.

THE BATAN DIALECT AS A MEMBER OF THE PHILIPPINE GROUP OF LANGUAGES

By OTTO SCHEERER

and

"F" AND "V" IN PHILIPPINE LANGUAGES

By CARLOS EVERETT CONANT

Order No. 407.

These two papers are issued under one cover, 141 pages, paper, \$0.80, postpaid.

THE SUBANUNS OF SINDANGAN BAY

By EMERSON B. CHRISTIE

Order No. 410. Paper, 121 pages, 1 map, 29 plates, \$1.25, postpaid.

Sindangan Bay is situated on the northern coast of Zamboanga Peninsula. The Subanuns of this region were studied by Mr. Christie during two periods of five and six weeks, respectively.

The 29 plates illustrate the Subanuns at work and at play; their industries, houses, altars, and implements; and the people themselves.

THE HISTORY OF SULU

By NAJEEB M. SALEEBY

Order No. 406. Paper, 275 pages, 4 maps, 2 diagrams, \$0.75, postpaid.

In the preparation of his manuscript for The History of Sulu, Doctor Saleeby spent much time and effort in gaining access to documents in the possession of the Sultan of Sulu. This book is a history of the Moros in the Philippines from the earliest times to the American occupation.

ETHNOLOGY—Continued

STUDIES IN MORO HISTORY, LAW, AND RELIGION

By NAJEEB M. SALEEBY

Order No. 405. Paper, 107 pages, 16 plates, 5 diagrams, \$0.25; half morocco, \$0.75; postpaid.

This volume deals with the earliest written records of the Moros in Mindanao. The names of the rulers of Magindanao are recorded in five folding diagrams.

NEGRITOS OF ZAMBALES

By WILLIAM ALLAN REED

Order No. 402. Paper, 83 pages, 62 plates, \$0.25; half morocco, \$0.75; postpaid.

Plates from photographs, many of which were taken for this publication, show ornaments, houses, men making fire with bamboo, bows and arrows, dances, and various types of the people themselves.

INDUSTRIES

PHILIPPINE HATS

By C. B. ROBINSON

Order No. 415. Paper, 66 pages, 8 plates, \$0.50 postpaid.

This paper is a concise record of the history and present condition of hat making in the Philippine Islands.

THE SUGAR INDUSTRY IN THE ISLAND OF NEGROS

By HERBERT S. WALKER

Order No. 412. Paper, 145 pages, 10 plates, 1 map, \$1.25, postpaid.

Considered from the viewpoint of practical utility, Mr. Walker's Sugar Industry in the Island of Negros is one of the most important papers published by the Bureau of Science. This volume is a real contribution to the subject; it is not a mere compilation, for the author was in the field and understands the conditions of which he writes.

A MANUAL OF PHILIPPINE SILK CULTURE

By CHARLES S. BANKS

Order No. 413. Paper, 53 pages, 20 plates, \$0.75, postpaid.

In A Manual of Philippine Silk Culture are presented the results of several years' actual work with silk-producing larvae together with a description of the new Philippine race.

THE PHILIPPINE
JOURNAL OF SCIENCE

B. TROPICAL MEDICINE

VOL. IX

SEPTEMBER, 1914

No. 5

MALARIA IN THE PHILIPPINE ISLANDS

I. EXPERIMENTS ON THE TRANSMISSION OF MALARIA WITH ANOPHELES
(MYZOMYIA) FEBRIFER SP. NOV., ANOPHELES (PSEUDOMYZOMYIA)
ROSSII, ANOPHELES (MYZORHYNCHUS) BARBIROSTRIS, ANOPH-
ELES (MYZORHYNCHUS) SINENSIS, AND ANOPHELES
(NYSSORHYNCHUS) MACULATUS *

BY ERNEST LINWOOD WALKER and MARSHALL A. BARBER
(From the Biological Laboratory, Bureau of Science, Manila, P. I.)

I. INTRODUCTION

The efficient and economical conduction of an antimalarial campaign in any country must be based not only upon accurate information of the anopheline mosquitoes and their distribution, but also upon the experimental determination of the ability of the different species to transmit malaria. As a practical example of the importance of this knowledge, it has been estimated ¹ that in the sanitation of the Panama Canal Zone between 100,000 and 250,000 dollars were saved by the knowledge that a certain anopheline mosquito, *Anopheles malefactor*, which breeds in the collections of water in hollow stumps, resulting from the extensive deforestation of the country, was unable to transmit malaria.

Of about 100 species of Anophelinæ now known, probably less than one-third have been definitely proved, either by the dis-

* Part II of this work, The distribution of the more common anophelines and the distribution of malaria, will appear in an early number of this Journal.

¹ Carter, H. R., *Am. Journ. Trop. Dis. & Prevent. Med.* (1913) 1, 43.

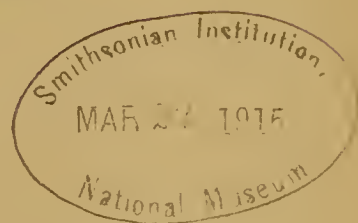

section of the naturally infected mosquitoes or by experimental infections, to be capable of transmitting malaria. The remaining species either have not been investigated or the evidence of their susceptibility is inconclusive or contradictory. Furthermore, it has been demonstrated that among the anophelines capable of transmitting malaria the different species vary widely in their susceptibility to infection with the malarial parasite and that the same species may not be capable of serving as vector of all three types of human malaria. Finally, it should not be overlooked that the same species of anopheline may vary in its susceptibility to infection with the malarial parasite in different countries or under different ecologic conditions. Such variations have been recorded in the susceptibility of *Glossina morsitans* to infection with *Typanosoma rhodesiense*.² A similar variation in susceptibility may account in part for the contradictory results obtained by different authors in their dissections of, or experiments with, certain anopheline mosquitoes.

These facts and possibilities make it impossible to predict the susceptibility of any species of Anophelinæ to infection with the malarial parasite, and render it imperative that every species be tested experimentally in order to be certain of the rôle played by it in the dissemination of malaria in any country.

There are two methods of determining the susceptibility of an anopheline mosquito to infection with the malarial parasites. One of these is the dissection of anophelines caught in houses harboring malarial patients, in order to determine the presence of oöcysts or sporozoites of the parasites in the mosquitoes: the other consists in experimentally infecting mosquitoes bred from larvæ, and afterwards dissecting the mosquitoes for the discovery of the developing parasites, or allowing them to bite healthy persons to prove their ability to transmit the infection.

It is frequently stated in the literature that such a mosquito has been experimentally infected with malarial parasites but has not been found infected in nature, with the implied conclusion that experimental infections furnish a less reliable index of the ability of the species to transmit malaria. However, we believe that the experimental infections, if properly conducted, supply the more reliable index of the relative susceptibility of different species. In mosquitoes examined for natural infection with malarial parasites it is impossible to determine whether or not the mosquito has had an opportunity to bite an infected person, whether or not if the opportunity presented itself it

² Kinghorn and York, *Ann. Trop. Med. & Parasit.* (1912), 6, 269-285.

was taken advantage of, if the mosquito did suck blood whether or not the blood contained gametes sufficiently numerous to infect the mosquito, and whether or not sufficient time had elapsed after the feeding for the parasites to attain development. In properly conducted experimental infections all of these essential factors are under complete control. We are also of the opinion that it is strong, if not wholly sufficient, proof of the capacity of a species of mosquito to transmit malaria if it can be infected with the malarial parasite and if the parasites develop sporozoites and infect the salivary glands, without subjecting healthy persons to the bites of the experimentally infected mosquitoes. It is improbable, although possible, that sporozoites should be developed, migrate to and infect the salivary gland of the mosquito, and yet be incapable of being injected into or of infecting man. As it is known that different species vary greatly in their ability to transmit malaria, it is of the greatest practical importance to determine the relative susceptibility of the different anophelines in any country. In most infection experiments hitherto performed, careful comparative tests have not been made to determine the relative susceptibility of the different species of anophelines. In some cases a rough estimation of the proportion of a given species that becomes infected has been obtained. However, to be of practical value, the test should be comparative of different species of anophelines in a given region. This can be accurately determined only by a large series of experiments in which the different species are fed at the same time upon the same malaria patients and in which only those mosquitoes that sucked a full meal of the infected blood are selected for dissection. Under these conditions of experimentation the percentages of infected mosquitoes, and the relative number of oöcysts in the infected individual of the several species, will give a reliable index of the relative susceptibility of these anophelines to infection with the malarial parasite.

Susceptibility, while the most important, is not the only factor in determining the importance of any species of mosquito in the transmission of malaria. Geographical distribution and prevalence of the species, its habitat in relation to the dwellings of man, and its avidity for human blood also play a more or less important part in determining the rôle of the different species. All of these factors must be determined for each species before we can estimate accurately their relative importance in the epidemiology of malaria in any country.

In the Philippine Islands the species and distribution of the

anopheline mosquitoes have been extensively, but not intensively and exhaustively, studied by Giles (1904), Banks (1906), Ludlow (1908), and others. The following species have been credited to the Philippine Islands:³

<i>Myzomyia funesta</i> Giles.	<i>Pyretophorus pitchfordii</i> Giles.
<i>Myzomyia thorntonii</i> Ludlow.	<i>Myzorhynchus barbirostris</i> van de Wulp.
<i>Myzomyia mangyana</i> Banks.	<i>Myzorhynchus pseudobarbirostris</i> Ludlow.
<i>Pseudomyzomyia rossii</i> Giles.	<i>Myzorhynchus sinensis</i> Wiedemann.
<i>Pseudomyzomyia ludlowii</i> Theobald.	<i>Myzorhynchus vanus</i> Walker.
<i>Pseudomyzomyia indefnata</i> Ludlow.	<i>Nyssorhynchus fuliginosus</i> Giles.
<i>Stethomyia pallida</i> Ludlow.	<i>Nyssorhynchus philippinensis</i> Ludlow.
<i>Pyretophorus minimus</i> Theobald.	<i>Celia kochi</i> Dönitz.
<i>Pyretophorus freeræ</i> Banks.	
<i>Pyretophorus philippinensis</i> Ludlow.	

It is probable that a revision of the synonymy of these species would reduce the number as well as change the names of some of these species, and it is certain that a more intensive study of the anopheline fauna of these Islands would disclose other species. As they stand, only 6 of the 17 species are reputed to be capable of transmitting malaria. Of these, *Anopheles funesta* probably does not occur in the Philippines, the capability of *Anopheles rossii* to transmit malaria is disputed, and the specific validity of *Anopheles ludlowii* is doubtful.

Of the 5 species considered in this paper, namely, *Anopheles febrifer* Banks sp. nov., *Anopheles rossii* Giles, *Anopheles barbirostris* van de Wulp, *Anopheles sinensis* Wiedemann, and *Anopheles maculatus* Theobald emend. Stanton, 2 are not contained in the above list and have not hitherto been credited to the Philippine Islands and 1 is a new species.

Anopheles febrifer was found very prevalent in Laguna Province. We have been unable to identify it with any of the hitherto described species of anophelines, although for a time we were inclined to believe it was the same as that identified by Ludlow in the Philippines as *Myzomyia funesta*. Mr. Banks, entomologist of the Bureau of Science, to whom it was referred, decided that it was a new species and named it *Myzomyia febrifer*.⁴ The more distinctive characters of the female of this species are as follows:

A small anopheline mosquito. Head dark brown, with white upright forked scales in the middle and a tuft of white hairs

³ Banks (1906).

⁴ *This Journal*, Sec. D (1914), 8, No. 4. See also the note on page 439.

projecting forward. Palpi dark brown, with two broad cream-white apical bands, one of which is terminal, separated by a narrow dark band, and one narrow white basal band. Proboscis dark brown with a tawny tip. Thorax light brown on the back and dark brown on the sides, and covered with hairlike curved scales. Wings spotted, with the light color slightly predominating; the front edge black, with 5 pale yellow spots and a pale-yellow tip; the fringe with light spots at the end of all of the veins except the sixth. Legs dark brown, with very narrow light bands at the joints. Abdomen dark brown, hairy.

The larvæ of *Anopheles febrifer* were found very abundant in shaded brooks of Laguna Province. They are found in depressions of the bank or under overhanging portions of the bank in the wooded streams, and especially where collections of drift twigs and leaves or tufts of rootlets were projecting into the water. This species also breeds in open brooks or irrigation ditches, if they contain running water and there is overhanging grass or other vegetation to furnish shade. As this is a hitherto unknown species, there are no data on its susceptibility to infection with, and its ability to transmit, malaria.

Anopheles rossii was first described by Giles in 1899. It is credited to the Philippines by Banks (1906) and Ludlow (1908). The synonymy of this species is as follows:

Anopheles rossii Giles, 1899.

Anopheles vagus Dönitz, 1902.

Myzomyia rossii Theobald, 1903.

Pseudomyzomyia rossii Theobald, 1907.

Nyssomyzomyia rossii James and Liston, 1911.

Anopheles ludlowii is a species nearly related to, if not a variety of, *Anopheles rossii*. It was first discovered by Ludlow in the Philippine Islands in 1903. She considered it to be a new species and sent it to Theobald, who named it. The synonymy of this species is as follows:

Anopheles ludlowii Theobald, 1903.

Myzomyia ludlowii Theobald, 1903.

Nyssomyzomyia ludlowii James and Liston, 1911.

The differential characters separating *ludlowii* from *rossii* are given by Theobald (1903) as follows:

A very variable species, somewhat like *rossii* at first sight, but easily told by the spotted (yellow) legs and much shorter fork-cells. The base of the first submarginal cell is always slightly nearer the apex of the wing, and the costal spots differ slightly, but are to some extent variable. The cross veins are most unstable. The palpi are very similar, but the apical band in *rossii* is rather longer. The chief difference is that in

rossii the second white band is a third of the way down the palpi; in this species (*ludlowii*) it is less, and the black intervening area is much smaller.

James and Stanton (1912) list the two as distinct species.

Stanton (1913) distinguishes the two species, but states that *Anopheles ludlowii* is nearly allied to *Anopheles rossii*.

Alcock (1913) describes the two species, but says that if it were not for the fact that *Anopheles ludlowii* is said to transmit malaria in the Andamans he would consider it a variety of *Anopheles rossii*.

Knab (1913) considers *Anopheles ludlowii* as a species closely resembling, but distinct from, *Anopheles rossii*.

Mr. Banks, entomologist of the Bureau of Science, considers *rossii* and *ludlowii* as variations in one and the same species, namely, *Anopheles rossii*. He states that this opinion is based upon examination of the type specimens of these two forms at the British Museum several years ago and that Theobald agreed with him at that time that *ludlowii* was not a distinct species.

All of the mosquitoes of the *rossii-ludlowii* group collected by us, both from fresh water in Laguna Province and from brackish water along Manila Bay in Rizal Province, have been of the *rossii* type. Since these experiments were completed, one of us (Barber) has collected in fresh water in Mindoro larvæ from which were bred an *Anopheles* with conspicuously spotted legs, possibly *ludlowii*. Our experimental infections reported in this paper have all been made with *Anopheles rossii*.

Anopheles rossii is, according to the observation of Banks (1906), Ludlow (1908), and ourselves, one of the most, if not the most, prevalent and widely distributed anophelines in the Philippines. This species may be found breeding everywhere in water open to the sunlight, both in fresh water and in the brackish or salt water of esteros along the extensive coast of the Archipelago. It will even breed in stagnant water if running water is not available. We have found the larvæ of this species in the esteros along Manila Bay, in salt beds used by the natives for evaporating sea water, in irrigated rice fields, open rivers, the overflow from artesian wells, carabao tracks filled with water, about water holes and troughs, carabao wallows, and even in the foul water of tanks used to soak sugar-cane stalks.

The evidence of the ability of *Anopheles rossii* and *Anopheles ludlowii* to transmit malaria is exceedingly contradictory.

In India all investigators appear to be agreed that *Anopheles rossii*, although one of the most prevalent species, is not of

practical importance in the transmission of malaria. Lühe (1906) gives the following table of comparative results of dissections by different authors of *Anopheles culicifacies* and *Anopheles rossii* captured in malarial houses in India:

TABLE I.—Malaria parasites found in *Anopheles culicifacies* and *Anopheles rossii* caught in houses in India.

Place.	Observer.	<i>Anopheles (Myzomyia) culicifacies.</i>		<i>Anopheles (Myzomyia) rossii.</i>	
		Dissected.	With sporozoites in the salivary glands.	Dissected.	With sporozoites in the salivary glands.
Mian Mir.....	Stephens and Christophers.....		<i>Per cent.</i>	324	0
Do.....	James.....	259	12-4.6	496	0
Ennur (fishing village near Madras). ^a	Stephens and Christophers.....	69	6-8.6	364	0
Do. ^b	James.....			18	0
Near Madras ^c	Cornwall.....	25	4-16	35	0

^a *Anopheles rossii* very rarely in the houses. *Anopheles culicifacies* incomparably less frequent; the 69 specimens are the total collection for almost a week.

^b In one of these 18 specimens, however, oöcysts were found.

^c Both species of mosquito were collected in the same houses and under the same conditions.

James (1902), however, states that he has obtained positive results in experimental infections of *Anopheles rossii* with simple tertian, malignant tertian, and quartan malarial parasites.

Schüffner (1902) worked on the experimental transmission of malaria at Deli, Sumatra, with a mosquito which he designates as "*Anopheles I.*" From his description and especially from his figures of this mosquito it is very probable that it was *Anopheles rossii*. Eysell (1910) is also of this opinion. Schüffner obtained undoubted infections of this species of mosquito with both tertian and subtertian malaria, as the excellent figures of sections of the mid-gut and salivary glands in his plates demonstrate, and he was successful in transmitting the infection with both types of malaria to healthy persons by bites of the experimentally infected mosquitoes.

Banks (1907) was the first investigator to determine experimentally the ability of identified specimens of *Anopheles ludlowii* to transmit malaria. He succeeded in infecting, and securing development of the malarial parasites up to the sporozoite stage in, mosquitoes which he found as larvæ in brackish water at Olongapo, Luzon, P. I., and which he identified as *Myzomyia ludlowii* by feeding them on the blood of a patient infected with subter-

tian malarial parasites. He was furthermore able to transmit the disease by allowing the experimentally infected mosquito to bite a healthy man who had volunteered to submit to the experiment. Banks now considers the *Myzomyia ludlowii* with which he experimented to be identical with *Anopheles (Myzomyia) rossii*.

In 1910 De Vogel infected and secured development of the malarial parasites up to the oöcyst stage in mosquitoes bred from the larvæ collected at Samarang, Java. He failed to follow the development of the parasites in the mosquitoes further because of the difficulties in keeping the mosquitoes alive sufficiently long in captivity. Infections were obtained with individuals bred from larvæ collected from brackish or salt water and not with individuals of the same species bred from the larvæ obtained from fresh water. De Vogel first identified the mosquitoes breeding in brackish or salt water as *Anopheles vagus* Dönitz, which is considered by some as a synonym of *Anopheles rossii* Giles. Specimens were submitted to Professor De Meyero of Amsterdam, and he declared them to be *Myzomyia rossii*. Individuals hatched from the same lot of larvæ as those infected were submitted to Theobald, who likewise pronounced them to be *Myzomyia rossii*.

Strong (1910), in the discussion of De Vogel's paper at the first biennial congress of the Far Eastern Association of Tropical Medicine held at Manila in 1910, made the following statement with reference to the transmission of malaria by *Anopheles ludlowii* or *rossii* in the Philippine Islands:

During the past year in connection with the work in the courses of tropical medicine in the Philippine Medical School relating to the study of malaria, we attempted to infect numerous specimens of *Myzomyia rossii* by exposing patients suffering with severe cases of æstivo-autumnal and tertian malaria to their bites. However, although these experiments were extensive and were carried on over a period of several months during the autumn, they were entirely unsuccessful. In no case did the dissection of any of these mosquitoes, although a large number were examined, reveal any oöcysts in the walls of the stomach, and in the study of stained sections made of the salivary glands no sporozoites could be detected. Later attempts to infect other human beings by the bites of specimens of *Myzomyia rossii*, which had been previously fed on the blood of patients suffering with severe malaria and whose blood certainly contained gametes, also failed. The larvæ of these mosquitoes were collected in the estuaries about the city.

Strong states that it is now known that *Myzomyia ludlowii* and *M. rossii* are one and the same species.

Christophers (1912) found *Anopheles (Nyssomyzomyia) ludlowii*, a species which breeds in and about salt swamps and which is not found at a greater distance than a kilometer and a half

from salt or brackish water, to be the chief carrier of malaria in the Andamans. The author is doubtful whether any part is taken in the transmission of malaria here by the other common species, *Nyssomyzomyia rossii* and *Myzorhynchus barbirostris*.

Stanton (1913) states that a large series of dissections and infection experiments, carried on by him in the Federated Malay States, failed to show any development of malarial parasites in *Anopheles rossii*.

Anopheles barbirostris is a common Malayan species, having the following synonymy:

Anopheles barbirostris van de Wulp, 1884.

Myzorhynchus barbirostris Theobald, 1903.

This species is reported in the Philippines by Banks (1906) and Ludlow (1908). We have found it breeding scatteringly but widely spread in Laguna Province. It was first found breeding in December in a semistagnant pool, which was densely shaded and contained growths of duck weed, pond lilies, and algæ. Later it was found breeding in open rivers and brooks, associated with *Anopheles rossii*, and to a lesser extent in shaded brooks, associated with *Anopheles febrifer*. Larvæ of this species are particularly to be found in collections of driftwood and dead leaves at the lower end of the semistagnant pools and under overhanging vegetation along the banks of open streams. The larvæ are rarely numerous and are usually found only scatteringly.

James (1902) states that he was successful in infecting and securing development of oöcysts and sporozoites of the malarial parasite in *Anopheles barbirostris*.

Schüffner (1902) describes and illustrates as "*Anopheles II*" an anopheline which is apparently *Anopheles barbirostris*. He was unsuccessful in attempts to transmit malaria with this species.

Stephens and Christophers (1906) do not include this species among those known to transmit malaria. However, Lühe (1906) states that Stephens and Christophers believe from the geographical distribution of this species that it may be a carrier of malaria.

Stanton (1912) was unable in eight trials to infect the Malayan strain of this species with the parasites of subtertian malaria.

Anopheles sinensis is another oriental species closely related to *Anopheles barbirostris*. Its synonymy is as follows:

Anopheles sinensis Wiedemann, 1828.

Myzorhynchus sinensis Theobald, 1901.

Anopheles jesoensis Tsuzuki, 1902.

Myzorhynchus peditaeniatus Leicester, 1908.

This species is reported in the Philippine Islands by Banks (1906) and Ludlow (1908). In April of the present year we found it breeding in a rice paddy in Laguna Province.

James (1902) states that he has not carried out any feeding experiments with this species.

Tsuzuki (1902) infected *Anopheles sinensis* (*jesoensis*) with the parasites of tertian malaria, and transmitted the infection to a healthy person; he believes it to be intimately concerned in the transmission of malaria in Japan.

Stephens and Christophers (1906) believe from its geographical distribution that *Anopheles sinensis* is of little importance in the transmission of malaria.

Stanton (1912) observed malaria zygotes in this species on two occasions in the Federated Malay States, but was unable to infect it under experimental conditions with the parasites of subtertian malaria.

Anopheles maculatus is a species whose identity has been very uncertain. The synonymy of this species is given by Stanton (1912) as follows:

Anopheles maculatus Theobald, 1901.

Anopheles maculata Theobald, 1901.

Nyssorhynchus maculatus Theobald, 1903.

Nyssorhynchus willmori Leicester nec James, 1908.

Nyssorhynchus pseudowillmori Theobald, 1910.

According to Stanton (1912), who has examined the type specimens of *Anopheles maculatus* Theobald, this confusion has arisen from the fact that the types are not male and female of the same species, but represent distinct species, the male being of the species known to oriental investigators as *maculatus* and the female of the species known to them as *karwari*. Stanton proposes to obviate this confusion by retaining the name *maculatus* for the species which is now well known under that name to the students in the Orient and to rename the species which had hitherto been known as *karwari*.

Alcock (1913) lists *Anopheles willmori* as a variety of *Anopheles maculatus*.

This species has not hitherto been credited to the Philippine Islands. Mr. Banks, entomologist of the Bureau of Science, states that he recently collected several specimens at Baguio, Mountain Province, at an altitude of about 1,500 meters, but the report of these has never been published. *Anopheles maculatus* is reputed to be essentially a mountain or highland species. However, we have found it breeding to a limited extent in Laguna Province, at an elevation of only about 100 meters above sea level.

The larvæ were found always along the banks of densely shaded brooks, limited in distribution, and more plentiful during the cool season.

Schüffner (1902) attempted experimental infections at Deli, Sumatra, with an anopheline described by him as "*Anopheles Ia*," which he considered a variety of his "*Anopheles I*" (*Anopheles rossii*). From his description and figure this species appears to be *Anopheles maculatus*. He was unable to get this species to bite or to suck human blood.

Stephens and Christophers (1906) list *Anopheles maculatus* among the species that have been proved to be capable of transmitting malaria, but in view of the confusion existing at the time they write as to the identity of this species their statement is not conclusive. In their diagnosis of this species they state that the female of *Anopheles maculatus* has four white bands on the palpi, which does not correspond to the revised species of Stanton, but rather to *Anopheles karwari*.

Stanton (1912) states that both he and Doctor Watson have found this species infected in nature, in the Federated Malay States, and that he has been able to infect it under experimental conditions with the parasites of subtertian malaria.

One other species, *Anopheles (Nyssorhynchus) fuliginosus* Giles, has been bred from our collection of larvæ, but not in sufficient numbers to determine its ability to transmit malaria. This species, however, is included by Stephens and Christophers (1906) among those capable of transmitting malaria; and Stanton (1912) states that he has infected *Anopheles fuliginosus* experimentally.

II. METHODS

This investigation was conducted at the Calamba Sugar Estate, Canlubang, Laguna Province, Luzon, about 60 kilometers from Manila. A moderate amount of malaria existed there among the Japanese and Filipino laborers. As malaria was not prevalent in Manila, Canlubang offered a satisfactory place for carrying on our experiments within a reasonable distance from the Bureau of Science. The officials of the Calamba Sugar Estate coöperated freely in the investigation. We are especially indebted to the resident physician of the company, Dr. Isaac S. Diller, who not only made available to us the hospital and patients for infection experiments, but took us into his home and permitted us to use one of his rooms in which to set up our temporary laboratory.

The Calamba Sugar Estate is situated in Laguna Province, Luzon, near the borders of a large lake, Laguna de Bay. Along

the borders of the lake the land is low and is for the most part devoted to the cultivation of rice with abundant irrigation from the numerous streams flowing through it. At a distance of several kilometers from the lake, the land rises to an extensive undulating plain elevated from one hundred to several hundred meters. This region is a part of the old Friar lands, devoted to the cultivation of sugar for many years during the Spanish rule. During the insurrection, in the latter years of the Spanish domination, much of it was laid waste and grew up to cogon grass or jungle. Since the American occupation it is rapidly being reclaimed and devoted to sugar cultivation again, both by the Filipinos in a small way and by several American and European companies on an extensive scale. The soil is fertile and unusually well watered. The region is crossed by numerous small rivers and brooks, many of which are fed by springs and flow throughout the dry season. These streams are peculiar in that they have in most cases cut deeply into the soil, forming deep ravines, and often into the underlying soft volcanic rock, forming cañons. The banks of the streams are for the most part densely covered with jungle vegetation. The lake, the extensive irrigated rice fields, and the innumerable rivers and brooks in this country afford abundant and varied breeding places for mosquitoes and furnish unlimited collecting grounds for the species of anophelines that occur in this region.

All of the mosquitoes used in our experiments have been collected and bred from larvæ. The species considered in this paper were all collected in Laguna Province on the Calamba Sugar Estate and adjacent country, with the exception of the strain of *Anopheles rossii* that breeds in brackish or salt water, the larvæ of which were collected in esteros on the borders of Manila Bay, about 50 kilometers distant, and brought to Canlubang.

COLLECTING LARVÆ OF MOSQUITOES

In collecting larvæ in the brooks and rivers, it has been found advantageous to wade the stream, preferably against the current. In this way the breeding places are more accessible, and it is often the only way to penetrate the jungle or to gain an entrance into the cañons peculiar to the region.

A variety of methods were tried in collecting larvæ. At first, white porcelain evaporating dishes, about 14 centimeters in diameter, were used. By dipping these dishes into every suspicious-looking pool, the larvæ, if present, were readily seen against the white background. When larvæ were found, the

excess of water was first poured off. This was readily accomplished, as the larvæ tend to swim against the current and collect at the opposite side of the dish. The remainder of the water with the larvæ was then poured into the collecting jar. However, the method finally adopted as the most efficient was the use of white granite-ware pans, about 20 centimeters long, 13 broad, and 5 centimeters deep, for dipping up the larvæ. The larvæ were then removed from the surface of the water in the pan with a large spoon, which for convenience was carried attached to the finger or belt of the collector by a string, and were placed in the collecting jar. This pan provides a larger surface for skimming the surface of the water, while the corners are readily inserted into small nooks. The larvæ can be removed rapidly with the spoon from the surface of the water in the pan with a minimum excess of water.

The collecting jar has usually consisted of a large wide-mouthed bottle of heavy glass, holding about one-half to three-fourths of a liter. One of these is attached to the belt of the collector by a cord about the neck, leaving both hands free to manipulate the dipping pan and spoon. On extended collecting trips it was necessary to take extra jars, which were carried by a boy in a hand bag. Occasionally these extra jars were replaced by a large 5-gallon can with a handle, which served as a storage receptacle for the larvæ.

Various methods were made use of to get rid of the excess of water which accumulated in the collecting jars. One of these consisted of a collecting can with an inner cylinder of fine wire gauze provided with a bottom and extending above the top of the can. This permitted the escape of the water without loss of the larvæ. Another method was to siphon off the water from the bottom of the jar. The latter method accomplishes the end without loss of the larvæ if it is done from an undisturbed jar in which the larvæ have collected at the surface. Two pieces of glass tubing connected by a short section of rubber tubing make a convenient siphon which can be carried in the pocket of the collector.

From our experience in this investigation, we wish to emphasize the advantages in experiments of this kind of collecting very large quantities of larvæ. Large numbers of the larvæ fail to develop and many of the adult mosquitoes die during the course of the experiments; therefore, time and labor will be saved ultimately if the collections of larvæ be made on as extensive a scale as possible.

BREEDING MOSQUITOES FROM THE LARVÆ

The collected larvæ were carried to the laboratory and placed with the water in the breeding jars. These consisted of battery jars, or large open-mouthed bottles, the tops of which were covered with netting secured by rubber bands. These jars were kept on the open veranda outside of the house. The sun-loving species were placed where they would get a certain amount of sunlight each day, and the shade-loving species were placed in a shaded position. Every morning the laboratory assistant aërated the breeding jars by passing a current of air to the bottom of the jar, as recommended by Darling (1910). A majority of the pupæ and large larvæ always developed, but many of the small larvæ failed to develop from lack of food or for other reasons.

When the pupæ had hatched and the mosquitoes had collected in the upper part of the breeding jar, they were allowed to escape into the biting cages. These latter consisted of lantern chimneys, as recommended by Darling (1910). The upper end of the chimney was covered with mosquito netting fastened by a rubber band, and the lower end was set into the half of a Petri dish. The supply of a proper amount of moisture to saturate the atmosphere, but not drown or sprawl the mosquitoes, was a problem of considerable importance and difficulty. In open dishes of water placed in the cages, the mosquitoes were frequently drowned, even when a float of cork was placed on the surface. In our earlier experiments small stender dishes, filled with absorbent cotton over which were placed several layers of filter paper, were filled with as much water as the cotton would absorb. This served the purpose fairly well, but as the hot season advanced the heavy mortality among the mosquitoes led us to seek other methods that might prolong the life of the insects. In an attempt to imitate natural conditions, the Petri dish bottoms of the cages were filled with moist earth containing a growing plant. This proved to be little, if any, superior to the saturated cotton, and molds rapidly developed on the moist earth. Finally the bottom of the cage was filled with washed sand, which was kept saturated with water. This method proved to be the most satisfactory. Sufficient water was supplied, and the sand served as a resting place for the mosquitoes without danger of drowning; a large surface for evaporation was furnished which saturated the atmosphere without condensation on the surface of the glass, in which the mosquitoes become sprawled; and there was no difficulty from the growth of molds.

In these cages the mortality of the mosquitoes was low, even during the hot season.

The cages were kept in a dark closet in the laboratory at room temperature. In order to keep out the ants, the legs of the closet were set in tins of petroleum. When not fed on blood, split raisins, placed on the netting covering the top of the cages, served as food for the mosquitoes. Every morning the cages were gone over and fresh water and food supplied. The cages were changed occasionally when they had become soiled. It was found that the mosquitoes bit better if no food was supplied before and between the feedings on blood.

IDENTIFICATION OF THE SPECIES OF THE MOSQUITOES

The species of each mosquito was determined when it was removed from the cage for dissection. All of the males and such females as died in every cage and the remains of every female dissected were preserved for confirmatory identification. These confirmatory identifications were made by Mr. Charles S. Banks.

THE SELECTION OF PATIENTS FOR INFECTING THE MOSQUITOES

A routine blood examination was made of every patient entering the hospital at the estate. In addition, large numbers of blood slides were made of the laborers in the bunk houses on the plantation and of the inhabitants of the outlying barrios. Whenever a blood slide showed malarial parasites, it was examined especially for the presence of gametes, and if they were found in numbers that appeared to justify it a differential count of the gametes and leucocytes was made to determine if the gametes were sufficiently numerous for use in infecting the mosquitoes. When a patient was found to be suitable for our experiments, attempts were made at once to induce him to submit to the bites of our experimental mosquitoes. This was usually accomplished by a little persuasion and a small monetary compensation. The hospital patients were available at any hour for our experiments; gamete carriers from the plantation or outlying barrios reported to us outside of their hours of labor, either in the evening or early in the morning. Gamete carriers from outside barrios were several times taken wholly into our employ, and paid the same wages they would have received if employed at their regular work. Such carriers were not given treatment, unless they developed marked symptoms, until we were through with them.

The number of gametes in the blood of patients was determined approximately by making a differential count of gametes and leucocytes. In a few of the earlier experiments the gametes were not counted. Following these, differential counts were made on thin blood smears, from 200 to 500 leucocytes being counted in each case. In the latter experiments, which include all of the more exact quantitative experiments, the differential counts were made on thick blood smears, in which from 1,500 to 3,000 leucocytes were counted. Darling (1910) has estimated that the limits of infectiousness of man to mosquitoes is about 1 gamete to 500 leucocytes, or 12 gametes to a cubic millimeter of blood. No patient was intentionally used in which the gametes approached the limits of infectiousness as estimated by Darling, and an effort was made to obtain patients for our experiments with as high a gamete count as possible in order to increase the probabilities of infection of the mosquitoes. Every time the mosquitoes were fed on a patient, a blood smear was taken for a gamete count in order to have information of the number of gametes in the blood at the time of feeding.

Some of the patients employed for the biting experiments were on quinine treatment. Darling (1910) claims, however, that this does not affect the infectiousness of the blood for mosquitoes. This question will be considered at length in the discussion of our experiments.

Thomson (1912) found that in a case of subtertian malaria, treated with quinine until all of the schizonts were killed, the gametes persisted for about twenty-one days; that is, the gametes of *Plasmodium præcox* (*falciparum*) are not affected by quinine and their life is about three weeks. This has not been wholly our experience. In tertian and quartan infections the gametes quickly disappear from the blood under quinine treatment, and frequently also without any treatment. On the other hand, the gametes of subtertian malaria are much more persistent. They have frequently persisted for weeks, whether or not the patient was under quinine treatment. Usually, however, the gametes after reaching the maximum gradually diminish in number whether or not the patient is being treated. Many of the gamete carriers showed few or no vegetative forms of the parasites in their blood, and frequently presented no symptoms over considerable periods of time. These were kept off quinine and used repeatedly for biting experiments.

INFECTING THE MOSQUITOES

The mosquitoes have, in most cases, been kept from twenty-four to forty-eight hours without food after emerging before use in our experiments. While at times they would bite well on the same day that they emerged, on the whole they bit better if kept without food until the second day. The time of feeding the mosquitoes on the malarial patients was for the most part in the early morning. The advantage of feeding the mosquitoes in the early morning, rather than in the evening, is that good light, necessary for separating the females that sucked blood from the empty females and the males, is available. Some attempts were made to induce them, by darkening the cage, to bite during the daytime, but with little success.

In the biting experiments, the lantern-chimney cage was removed from the Petri plate and netting placed over the lower end. The sides and bottom of the cage were wrapped with black cloth, and the top, covered with netting, was applied to the moistened skin of the patient. By holding the gauze-covered end toward the light before applying it to the patient, most of the mosquitoes could be induced to collect on the netting, which was then applied to the skin of the patient. In most cases the arm, but in some cases the body, of the patient was used for biting. It was found convenient to place several cages in a row in a valise or box not deeper than the height of the cages to hold them in position, and then have the patient rest his arm on the tops of the cages. Three or four cages and sometimes more were fed at one time on the patient. The cages were left in position until the patient felt no more bites or until it was considered that no more of the mosquitoes would bite. This was usually from fifteen to thirty minutes.

After the feeding, the gauze on the lower end of the cage was removed and the cage replaced over the Petri dish. Our lots of mosquitoes were allowed to bite the malarial patient on one, two, or three, or even more successive nights or mornings as circumstances or the purpose of our experiments demanded. During this period they were given no other food. After the feedings on infected blood were completed, the mosquitoes were supplied with raisins and sufficient water and were kept in the dark closet until ready for dissection.

In the preliminary experiments to determine the capabilities of the different species of mosquitoes to become infected with the malarial parasites, no attempt was made to separate the

mosquitoes that bit from those that did not bite the infected patient nor the males from the females. The mosquitoes were, when possible, given several opportunities to feed on blood on successive evenings, and it was presumed that the majority availed themselves of the opportunity. However, it is probable that a greater or less number of them failed on every occasion to suck blood. In the later experiments, in order to obtain an accurate comparison of the susceptibility of the different species proved to be capable of carrying malaria, the different species were fed simultaneously on the same gamete carrier and then the females full of blood were separated from the empty or doubtful females and the males. This was accomplished by feeding the mosquitoes in large numbers in the cages in the ordinary manner and then removing them individually from the cages in test tubes and examining them with a hand lens to determine whether or not they were full of blood. This was determined by the distinct red color of the abdomen of those which are gorged with fresh blood. The examination must be made shortly after feeding on the patient, as the blood becomes dark in color a few hours after it is ingested. The swollen condition of the abdomen is not a safe criterion, especially in the dark-bodied species like *Anopheles barbirostris*, because this condition may be due to engorgement with water or raisins used as food. Those full of blood were then liberated together in a fresh cage. The mosquitoes in the comparative cages containing the different species fed simultaneously on the same patient were then dissected on the same date to determine the proportion of infections and the relative number of oöcysts in the infected individuals.

DISSECTION OF THE MOSQUITOES

In the experiments to determine the capability of the different species to become infected, the mosquitoes were kept alive from five to ten days after the last feeding on infected blood before dissection; that is, long enough to obtain well-developed oöcysts, but not until the sporozoites had escaped from the oöcysts. The advantages of such early dissections for the purpose intended are that there is less loss of the mosquitoes by death and a considerable saving of time in the dissections, as it is only necessary to examine the mid-gut. The dissection of the salivary glands takes much more time and careful work.

The mosquitoes to be dissected were killed in the cage by a few drops of chloroform. The males when present were re-

moved, and each female, as she was removed from the cage for dissection, was carefully examined for the identification of the species, as it is not uncommon for two or more species to be represented in the same cage. When only the mid-gut was dissected, the thorax and head were preserved for later confirmatory identification.

The dissection of the mid-gut was performed according to the method described by Stephens and Christophers (1906). The mosquito is laid on a glass microscope slide over a white card on which is a blackened area. Over the white background, the abdomen of the mosquito is cut off at its junction with the thorax with a sharp needle. The abdomen is then moved over the black background, and a drop of physiological salt solution is placed upon it. The abdomen is held at the proximal end by one dissecting needle, while a second needle is pressed on the terminal segment and gentle traction exerted. With proper care and experience, the intestinal tract and the ovaries will be drawn out intact, attached to the terminal segment. If the hind-gut breaks off, leaving the mid-gut in the abdomen, it can be dissected out by slitting the wall of the abdomen with dissecting needles. The mid-gut is then cut off, and all of the Malpighian tubules are carefully removed with the needles, otherwise they tend to lie over the mid-gut and obstruct the microscopic view. All of this dissection should be made under a simple lens supported by a holder. A cover glass is then placed over the mid-gut, and it is examined first with the low power and then with the high-power dry lens of the compound microscope for oöcysts. At the period of development at which our dissections were made, the oöcysts could always be identified with a Zeiss DD objective, and usually with the AA objective. The immature oöcysts of this age appear against the granular background of the gut wall, as round or slightly oval, transparent, structureless, feebly refractive bodies, 19 to 42 microns in diameter, and having a definite wall. Their identity is made certain by the presence of malarial pigment in the protoplasm. The older oöcysts, in which the sporoblasts or sporozoites have developed, are larger, more granular, and darker in appearance, and the sporoblasts or sporozoites in them are readily recognized with the higher magnification.

In order to determine whether the malarial parasites were capable of attaining complete development in the several species of the mosquitoes, it was considered necessary to give the para-

sites an opportunity to develop sporozoites and infect the salivary glands. For this purpose, mosquitoes which had fed on infected blood were kept alive for from twelve to eighteen days before dissection. Both the mid-gut and the salivary glands were then dissected. In removing the salivary glands from the mosquito, the methods described by Stephens and Christophers (1906) were employed. The legs and wings of the mosquito, the abdomen of which had already been removed for the dissection of the mid-gut, are cut off with a sharp needle, the cuticle at the prothorax is torn with the needle, the slide is placed over a black background, the thorax is held by one dissecting needle, while gentle traction is exerted on the head with a second needle. This will, if properly done, draw out the salivary glands from the thorax attached to the head. They are then cut off from the head with a sharp needle, a cover glass is placed over them, and they are examined with the high dry and then with the oil-immersion objective of the compound microscope for the presence of sporozoites. In case of failure to remove the salivary glands by this method, they can still be found by carefully teasing apart the tissues of the anterior ventral part of the thorax.

The mid-guts when found infected were preserved. In most cases the entire mid-gut was placed in 0.85 per cent sodium chloride solution containing 10 per cent formalin. In a few cases Schaudinn's sublimate alcohol mixture was used as a fixative, after which the organs were preserved in 70 per cent alcohol. Smears were made of the infected salivary glands, which were stained by Giemsa's stain, by sliding off the cover glass. Sections were not made for diagnosis, as the dissection method is much quicker and simpler; but in a few cases sections were cut for permanent preparations.

III. EXPERIMENTS

There is a notable lack of detail in the reports of most authors on their experiments in infecting mosquitoes with malarial parasites. For this reason, and because our experiments have been more extensive and more quantitatively accurate than those hitherto performed, it has seemed desirable to give a detailed account of our investigation. In order first to present a comprehensive view of our experiments in a form that will economize space and at the same time facilitate a comparison of the data and the results, their essential facts are tabulated in Table II.

TABLE II.—Data of all (184) the experiments to infect anopheline mosquitoes with malarial parasites.

No. of experiment.	Species of <i>Anopheles</i> .	Malaria patient used for infecting mosquitoes.			Date mosquitoes fed on malaria patient.	Date mosquitoes were dissected.
		No.	Type of malaria.	Gametes per 100 leucocytes in blood.		
1	<i>A. rossii</i>	808	Tertian.....	—	{ Dec. 12, 16	
2	do.....	1251	Subtertian.....	+	Dec. 13	Dec. 19.
3	do.....	808	Tertian.....	++	Dec. 15	Do.
4	do.....	1251	Subtertian.....	+	Dec. 16	Dec. 24.
5	{ do.....	1251	do.....	—	Dec. 17	Dec. 23.
6	<i>A. maculatus</i>	1372	Quartan.....	—	Dec. 18, 19, 20	
7	<i>A. rossii</i>	808	Subtertian.....	++	Dec. 21, 22	Dec. 29.
8	do.....	808	do.....	++	Dec. 23, 24	Jan. 1.
9	do.....	1413	Tertian.....	+++	Dec. 26, 27, 28	Jan. 5.
10	do.....	1413	do.....	+++	do.....	Do.
11	<i>A. maculatus</i>	1413	do.....	++	Dec. 27, 28	Jan. 6.
12	<i>A. rossii</i>	808	Subtertian.....	2, 3-3, 8	do.....	Jan. 9.
13	do.....	808	do.....	2, 3-3, 8	do.....	Do.
14	do.....	1251	do.....	20, 0	Dec. 31, Jan. 2, 4	Do.
15	<i>A. maculatus</i>	1251	do.....	20, 0	do.....	Do.
16	<i>A. rossii</i>	1251	do.....	20, 0	do.....	Do.
17	<i>A. maculatus</i>	1251	do.....	++	Jan. 6, 7	Jan. 15.
18	<i>A. rossii</i>	1251	do.....	++	do.....	Jan. 17.
19	do.....	1251	do.....	++	do.....	Do.
20	{ do.....	1251	do.....	2, 8-7, 2	Jan. 8, 9	Jan. 18.
21	<i>A. barbirostris</i>	1251	do.....	2, 8-7, 2	do.....	Do.
22	<i>A. rossii</i>	1251	do.....	2, 8-7, 2	do.....	Do.

TABLE II.—Data of all (184) the experiments to infect anopheline mosquitoes with malarial parasites—Continued.

No. of experiment.	Species of <i>Anopheles</i> .	Malaria patient used for infecting mosquitoes.			Date mosquitoes fed on malaria patient.	Date mosquitoes were dissected.
		No.	Type of malaria.	Gametes per 100 leucocytes in blood.		
23	<i>A. maculatus</i>	1261	Subtertian	0.6-2.0 +	Jan. 10, 11, 12	Jan. 22.
24	<i>A. rossii</i>	1261	do	0.6-2.0 +	do	Do.
25	<i>A. barbivostris</i>	1261	do	0.6-2.0 +	do	Jan. 23.
26	<i>A. rossii</i>	1486	Tertian	3.0-3.5	Jan. 12, 13, 14	Do.
27	<i>A. barbivostris</i>	1486	do	3.0-3.5	do	Do.
28	<i>A. rossii</i>	1486	do	3.8-3.5	Jan. 13, 14	Do.
29	do	1506	do	+	Jan. 15, 16	Jan. 24.
30	do	1506	do	+	do	Do.
31	do	1345	do	+	Jan. 17, 18	Jan. 29.
32	<i>A. barbivostris</i>	1345	do	+	do	Jan. 27.
33	<i>A. rossii</i>	1345	do	+	do	Jan. 29.
34	do	223	Subtertian	8.0	Jan. 21	Jan. 30.
35	<i>A. barbivostris</i>	223	do	8.0	do	Do.
36	<i>A. febrifer</i>	223	do	8.0	do	Do.
37	<i>A. maculatus</i>	223	do	8.0	do	Do.
38	<i>A. barbivostris</i>	223	do	14.0	Jan. 22	Do.

39	do	223	do	14.0	do	Jan. 31.
	{ <i>A. barbirostris</i>					
40	{ <i>A. rossii</i>	223	do	14.0	do	Do.
41	{ <i>A. barbirostris</i>					
42a	<i>A. rossii</i>	223	do	14.0	do	Do.
44	do	1240	Tertian	+ - 0.86	Jan. 24, 26	Feb. 2.
	do	1240	do	0-0.86	Jan. 24, 26	Do.
45	do	1240	do	0-0.86	do	Feb. 3.
	{ <i>A. barbirostris</i>					
46	<i>A. rossii</i>	1240	do	+	Jan. 26	Do.
47	do	1548	do	6.0	do	
48	<i>A. febrifer</i>	1548	do	6.0	Jan. 26, 27	Do.
49	{ <i>A. barbirostris</i>					
	{ <i>A. rossii</i>	1548	do	0-6.0	Jan. 26, 27, 28	Feb. 5.
50	do	1548	do	0-6.0	do	Feb. 4.
51	<i>A. febrifer</i>	1548	do	0-6.0	Jan. 27, 28	Feb. 5.
52	do	1548	do	0	Jan. 28	Do.
53	<i>A. rossii</i>	223	Subtertian	6.0	Jan. 31, Feb. 1	Feb. 13.
54	do	223	do	6.0	do	Do.
55	do	223	do	6.0	Feb. 1	Feb. 14.
56	{ <i>A. febrifer</i>					
	{ <i>A. barbirostris</i>	223	do	5.8-6.0	Feb. 2, 3	Do.
57	<i>A. rossii</i>	223	do	5.8-5.9	do	Do.
58	<i>A. febrifer</i>	223	do	5.6-5.9	Feb. 3, 4	Do.
59	<i>A. rossii</i>	223	do	5.6	Feb. 4	Do.
60	do	223	do	5.6	do	Feb. 20.
61	{ <i>A. febrifer</i>					
	{ <i>A. barbirostris</i>	223	do	4.5-4.8	Feb. 5, 6	Feb. 14.
62	{ <i>A. febrifer</i>					
	{ <i>A. maculatus</i>	223	do	4.5-4.8	do	Do.
63	<i>A. rossii</i>	223	do	4.8	Feb. 5	Do.
64	do	223	do	4.8	do	Feb. 20.
65	{ <i>A. maculatus</i>					
	{ <i>A. febrifer</i>	223	do	4.5	Feb. 6	Do.
	{ <i>A. barbirostris</i>					

TABLE II.—Data of all (184) the experiments to infect anopheline mosquitoes with malarial parasites—Continued.

No. of experiment.	Species of <i>Anopheles</i> .	Malaria patient used for infecting mosquitoes.			Date mosquitoes fed on malaria patient.	Date mosquitoes were dissected.
		No.	Type of malaria.	Gametes per 100 leucocytes in blood.		
66	<i>A. rossii</i>	223	Subtertian	4.5	Feb. 6	Feb. 20.
67	do.....	223	do	3.6-4.1	Feb. 7	Do.
68	<i>A. febrifer</i>	223	do	3.6-4.1	do	Do.
69	<i>A. rossii</i>	223	do	3.6-4.1	do	Do.
70	<i>A. maculatus</i>	223	do	2.9-3.6	Feb. 7, 8	Do.
71	<i>A. febrifer</i>	223	do	1.1-2.9	Feb. 8, 9	Feb. 21.
72	<i>A. rossii</i>	223	do	2.9	Feb. 8	Do.
73	<i>A. febrifer</i>	223	do	2.9	Feb. 8, 9	Feb. 14.
74	do.....	223	do	1.1	Feb. 9	Feb. 21.
75	<i>A. maculatus</i>	223	do	1.2	do	Do.
76	<i>A. rossii</i>	223	do	1.2	Feb. 10	Do.
77	<i>A. maculatus</i>	1612	do	10.0	Feb. 10, 11, 12	Feb. 27.
78	<i>A. febrifer</i>	1612	do	10.0	Feb. 10, 11	Do.
79	<i>A. rossii</i>	1612	do	9.1	Feb. 11, 12	Do.
80	<i>A. febrifer</i>	1612	do	9.1	do	Do.
81	<i>A. barbitrostris</i>	1612	do	8.2-9.1	Feb. 12, 14, 15, 16	Feb. 28.
	<i>A. rossii</i>					

82	<i>A. barbirostris</i> A. rossii A. febrifer	1612	do	8.2-8.9	Feb. 14, 15, 16	Do.
83	<i>A. maculatus</i> A. barbirostris A. rossii A. febrifer	1612	do	—	Feb. 14	Mar. 2.
84	<i>A. barbirostris</i> A. rossii A. maculatus A. febrifer	1612	do	8.2-8.9	Feb. 15, 16	Do.
85	<i>A. barbirostris</i> A. febrifer	1612	do	8.2-8.9	do	Mar. 3.
86	<i>A. barbirostris</i> A. febrifer A. maculatus A. rossii	1612	do	8.3-11.2	Feb. 16, 17, a. m.; 17, p. m.; 18	Do.
87	<i>A. febrifer</i> A. rossii	1612	do	11.2	do	Mar. 6.
88	<i>A. febrifer</i>	1612	do	8.3-11.2	Feb. 16, 17, a. m.; 17 p. m.; 18, a. m.; 18, p. m.; 19.	Do.
89	do	1612	do	7.0-11.2	do	Do.
90-91	do	1612	do	8.4-11.2	Feb. 18, 19, a. m.; 19, p. m.; 20, a. m.; 20, p. m.	Do.
92	do	1612	do	8.4-8.8	Feb. 19, p. m.; 20, a. m.; 20, p. m.	Feb. 28.
93	do	1612	do	6.7-7.3	Feb. 20, 21	Mar. 7.
94	<i>A. maculatus</i> A. febrifer	1612	do	6.1-2.3	Feb. 20, 21, a. m.; 21, p. m.; 22	Do.
95	do	1612	do	6.7-7.3	Feb. 20, 21	Feb. 28.
96	<i>A. rossii</i> A. febrifer	1612	do	6.7-7.3	do	Do.
97	<i>A. rossii</i>	1612	do	6.7-7.3	Feb. 21, 22	Mar. 7.
98	do	1612	do	6.1	Feb. 22	Mar. 3.
99	<i>A. febrifer</i> A. barbirostris	1612	do	6.1	do	Do.
101	<i>A. rossii</i>	1612	do	8.0	Feb. 23	Mar. 6.
102	<i>A. febrifer</i>	1612	do	8.0	do	Do.

TABLE II.—Data of all (184) the experiments to infect anopheline mosquitoes with malarial parasites—Continued.

No. of experiment.	Species of <i>Anopheles</i> .	Malaria patient used for infecting mosquitoes.			Date mosquitoes fed on malaria patient.	Date mosquitoes dissected.
		No.	Type of malaria.	Gametes per 100 leucocytes in blood.		
103	<i>A. febrifer</i>	1612	Subtertian	4.4-8.0	{Some on Feb. 22, 28.	{Mar. 12.
104	<i>A. rossii</i>					
105	{ <i>A. febrifer</i>	1612	do	3.5	Feb. 25	Mar. 6.
	<i>A. barbirostris</i>					
106	{ <i>A. febrifer</i>	1612	do	3.5	do	Do.
	<i>A. barbirostris</i>					
107	<i>A. rossii</i>	1197	do	13.3	Feb. 27	Do.
108	<i>A. febrifer</i>					
109	<i>A. rossii</i>	1197	do	13.3	do	Do.
	<i>A. febrifer</i>					
110	<i>A. febrifer</i>	1197	do	11.0	Feb. 28	Do.
111	do					
112	<i>A. rossii</i>	1197	do	11.9	Mar. 1	Mar. 7.
113	do					
114	do	1197	do	5.8	Mar. 2	Do.
	<i>A. febrifer</i>					
115	do	1197	do	10.9	Feb. 28	Do.
	<i>A. febrifer</i>					
116	do	1197	do	5.8-10.9	{Some on Feb. 28	{Mar. 12.
117	<i>A. febrifer</i>					
118	{do	1197	do	5.8	Others on Mar. 3	Do.
	<i>A. rossii</i>					
119	do	1197	do	3.4	Mar. 3	Do.
	<i>A. febrifer</i>					
120	{ <i>A. febrifer</i>	1197	do	5.1	do	Do.
	<i>A. barbirostris</i>					

121	<i>A. febrifer</i>	1197	do	3.0	Mar. 4	Do.
	{ <i>A. barbirostris</i>					
122	{ <i>A. febrifer</i>	1197	do	5.1	Mar. 3	Do.
	{ <i>A. rossii</i>					
123	do	1559	Quartan	5.0	Mar. 4	Do.
124	{ <i>A. febrifer</i>	1559	do	5.0	do	
	{ <i>A. barbirostris</i>					
126	<i>A. febrifer</i>	1197	Subtertian	3.0	do	
	do					
127	{ <i>A. rossii</i>	1559	Quartan	4.0	Mar. 5	
	{ <i>A. febrifer</i>	1559	do	4.0	do	Do.
	do					
129	{ <i>A. rossii</i>	1559	do	4.0	do	Do.
	{ <i>A. barbirostris</i>					
130	{ <i>A. febrifer</i>	1559	do	2.5	Mar. 6	Do.
	{ <i>A. barbirostris</i>					
131	{ <i>A. febrifer</i>	1559	do	2.5	do	Do.
	{ <i>A. rossii</i>					
	{ <i>A. barbirostris</i>					
132	<i>A. rossii</i>	1559	do	2.5	do	
133	<i>A. barbirostris</i>	1559	do	—	Mar. 7	
134	{ <i>A. febrifer</i>	1559	do	—	do	Mar. 13.
	{ <i>A. barbirostris</i>					
135	<i>A. rossii</i>	1559	do	—	do	Do.
136	{ <i>A. febrifer</i>	1559	do	—	do	Do.
	{ <i>A. barbirostris</i>					
138	<i>A. febrifer</i>	1559	do	1.05	Mar. 8	Do.
139	<i>A. rossii</i>	1559	do	1.05	do	Do.
140a	{ <i>A. febrifer</i>	1312	Subtertian	1.7-3.7	Mar. 18 or 19	Mar. 28.
	{ <i>A. rossii</i>					
	{ <i>A. barbirostris</i>					
146a	{ <i>A. febrifer</i>	1312	do	3.2-3.6	{ Mar. 19, 6 p. m	Do.
	{ <i>A. rossii</i>				{ Mar. 20, 6 p. m	
	{ <i>A. barbirostris</i>					

TABLE II.—Data of all (184) the experiments to infect anopheline mosquitoes with malarial parasites—Continued.

No. of experiment.	Species of Anophelins.	Malaria patient used for infecting mosquitoes.			Date mosquitoes fed on malaria patient.	Date mosquitoes were dissected.
		No.	Type of malaria.	Gametes per 100 leucocytes in blood.		
146b	<i>A. febrifer</i>	1312	Subtertian	1.9-3.8	Mar. 20, 6 p. m.	Mar. 28.
	<i>A. barbirostris</i>				Mar. 21, 6 a. m.	
150a	<i>A. febrifer</i>	1312	do	3.2	Mar. 20, 6 a. m.	Mar. 29.
	<i>A. rossii</i>					
151	<i>A. barbirostris</i>	1312	do	3.2	do	Apr. 7.
	<i>A. rossii</i>					
152	do	1312	do	1.9	Mar. 21, 6 a. m.	Mar. 29.
153	<i>A. febrifer</i>	1312	do	1.9	do	Do.
	<i>A. rossii</i>					
154	do	1312	do	1.9	do	Do.
	do					
155a	<i>A. barbirostris</i>	1312	do	3.5	Mar. 22, 6.30 a. m.	Apr. 7.
	<i>A. rossii</i>					
157	<i>A. barbirostris</i>	1312	do	3.5	Mar. 22, 6 a. m.	Mar. 30.
	<i>A. febrifer</i>					
158a	<i>A. febrifer</i>	1312	do	3.5	do	Do.
	<i>A. barbirostris</i>					
159	<i>A. barbirostris</i>	1312	do	3.0	Mar. 23, 6 a. m.	Apr. 7.
	<i>A. febrifer</i>					
161	<i>A. febrifer</i>	1312	do	3.0	do	Mar. 30.
	<i>A. rossii</i>					
162	<i>A. barbirostris</i>	1312	do	3.0	do	Do.
	<i>A. rossii</i>					
163	<i>A. febrifer</i>	1312	do	3.0	do	Do.
	<i>A. rossii</i>					
166a	<i>A. febrifer</i>	1312	do	3.0	Mar. 24, 6 a. m.	Mar. 31.
	<i>A. barbirostris</i>					
170a	<i>A. febrifer</i>	1312	do	3.0	Mar. 25, 6 a. m.	Apr. 1.
	<i>A. barbirostris</i>					

172	<i>A. febrifer</i>	1312	do	3.0	Mar. 26, 6 a. m.	Do.
173	<i>A. rossii</i>	1312	do	3.0	do	Do.
174	<i>A. barbirostris</i>	1312	do	3.0	do	Do.
175	<i>A. rossii</i>	1312	do	3.2	Mar. 27, 6 a. m.	Apr. 8.
176	<i>A. febrifer</i>	1312	do	3.2	do	Do.
177	<i>A. rossii</i>	1312	do	3.2	do	Do.
178	<i>A. barbirostris</i>	1312	do	3.2	do	Do.
179	<i>A. febrifer</i>	1312	do	2.6	Mar. 28, 6 a. m.	Apr. 13.
180	<i>A. maculatus</i>	1312	do	2.0	Mar. 29, 6 a. m.	Do.
181	<i>A. febrifer</i>	1312	do	2.0	do	Do.
182	<i>A. rossii</i>	1312	do	2.0	do	Do.
183	<i>A. febrifer</i>	1312	do	2.0	do	Do.
184	<i>A. barbirostris</i>	1312	do	1.8	Mar. 30, 6 a. m.	Apr. 14.
185	<i>A. rossii</i>	1312	do	1.8	do	Do.
186a	<i>A. barbirostris</i>	1312	do	1.5	Apr. 1, 6 a. m.	Do.
186b	<i>A. rossii</i>	1786	do	87.0	Apr. 2, 6 a. m.	Do.
189a	<i>A. febrifer</i>	1786	do	78.9	Apr. 3, 6 a. m.	Do.
190a	<i>A. rossii</i>	1786	do	78.9	do	Do.
191	<i>A. barbirostris</i>	1312	do	0.9	Apr. 6, 6 a. m.	Apr. 20.
192	<i>A. febrifer</i>	1806	do	32.0	Apr. 7, 6 a. m.	Do.
193a	<i>A. rossii</i>	1806	do	32.0	do	Do.
194a	<i>A. barbirostris</i>	1806	do	32.0	do	Do.
199	<i>A. sinensis</i>	1806	do	34.0	Apr. 8, 6.30 a. m.	Apr. 14.
200a	<i>A. febrifer</i>	1806	do			
201a	<i>A. barbirostris</i>	1806	do			
202	<i>A. rossii</i>	1806	do			
204	<i>A. sinensis</i>	1806	do			

TABLE II.—Data of all (184) the experiments to infect anopheline mosquitoes with malarial parasites—Continued.

No. of experiment.	Species of Anopheles.	Malaria patient used for infecting mosquitoes.			Date mosquitoes fed on malaria patient.	Date mosquitoes were dissected.
		No.	Type of malaria.	Gametes per 100 leucocytes in blood.		
205a	{ <i>A. rossii</i> . <i>A. barbirostris</i>	1806	Subtertian	34.0	Apr. 8, 6.30 a. m.	Apr. 20.
207a	{ <i>A. rossii</i> . <i>A. barbirostris</i>	1806	do	35.4	Apr. 9, 6 a. m.	Do.
211	{ <i>A. sinensis</i> . <i>A. febrifer</i>	1806	do	32.9	Apr. 10, 6 a. m.	Do.
212	{ <i>A. rossii</i> . <i>A. barbirostris</i>	1806	do	32.9	do	Do.
216	{ <i>A. sinensis</i> . <i>A. febrifer</i>	1806	do	(a)	Apr. 11, 6.30 a. m.	Do.
217	{ <i>A. barbirostris</i> . <i>A. febrifer</i>	1806	do	(a)	do	Do.
219	{ <i>A. rossii</i> . <i>A. febrifer</i>	1806	do	(a)	do	Do.
220	{ <i>A. rossii</i> . <i>A. barbirostris</i>	1806	do	24.8	Apr. 12, 6 a. m.	Apr. 21.
221a	{ <i>A. rossii</i> . <i>A. sinensis</i>	1806	do	24.8	do	Do.
224	{ <i>A. febrifer</i> . <i>A. rossii</i>	1806	do	20.8	Apr. 13, 6 a. m.	Do.
227a	{ do <i>A. barbirostris</i>	1806	do	—	Apr. 14, 6 a. m.	Do.

^a Gamete count the day before was 32.9 per cent; and the day after feeding, 24.8 per cent.

TABLE II.—Data of all (184) the experiments to infect *Anopheles* mosquitoes with malarial parasites.

No. of experiment.	Species of <i>Anopheles</i> .	Mosquitoes dissected.			Mosquitoes infected.			Per cent of mosquitoes infected (total).
		Mid-gut.	Salivary glands.	Total.	Mid-gut.	Salivary glands.	Total.	
1	<i>A. rossii</i>	1		1				
2	do.....	1		1				
3	do.....	1		1				
4	do.....	(*)						
5	do.....	1		1				
	{ <i>A. maculatus</i>							
6	<i>A. rossii</i>	(a)						
7	do.....	2		2				
8	do.....	28		28				
9	do.....	8		8				
10	do.....	10	7	17			1	10.00
11	<i>A. maculatus</i>	4	4	8				
12	<i>A. rossii</i>	13	1	14				
13	do.....	1		1				
14	do.....	4		4			4	100.00
15	<i>A. maculatus</i>	1		1				
16	<i>A. rossii</i>	1		1			1	100.00
17	<i>A. maculatus</i>	10		10				
18	<i>A. rossii</i>	12		12				
19	do.....	14		14				
20	do.....	11		11				
	{ <i>A. barbirostris</i>							
21	do.....	4		4				
22	<i>A. rossii</i>	(a)						
	{ <i>A. maculatus</i>							
23	<i>A. rossii</i>	6 <i>maculatus</i> 1 <i>rossii</i>	4 <i>maculatus</i> 1 <i>rossii</i>	7				

^a All of the mosquitoes died before date of dissection.

TABLE II.—Data of all (184) the experiments to infect anopheline mosquitoes with malarial parasites—Continued.

No. of experiment.	Mosquitoes dissected.				Mosquitoes infected.			Per cent of mosquitoes infected (total).
	Species of <i>Anopheles</i> .	Mid-gut.	Salivary glands.	Total.	Mid-gut.	Salivary glands.	Total.	
24	<i>A. barbirostris</i>	9.....	7.....	9.....				
25	{ <i>A. rossii</i>	4 <i>rossii</i>	3 <i>rossii</i>	10.....				
	{ <i>A. barbirostris</i>	6 <i>barbirostris</i>	5 <i>barbirostris</i>					
26	{ <i>A. rossii</i>	2 <i>rossii</i>		4.....				
	{ <i>A. barbirostris</i>	2 <i>barbirostris</i>						
27	{ <i>A. rossii</i>	3 <i>barbirostris</i>		3.....				
	{ <i>A. barbirostris</i>							
28	<i>A. rossii</i>	5.....		5.....				
29	do.....	5.....		5.....				
30	do.....	7.....		7.....	1.....		1.....	14.28
31	{ do.....	7 <i>rossii</i>	5.....	9.....				
	{ <i>A. barbirostris</i>	2 <i>barbirostris</i>				1 <i>rossii</i>		1.....
32	<i>A. rossii</i>	3.....		3.....				
33	{ do.....	9.....		9.....				
	{ do.....	8 <i>rossii</i>				1.....		1.....
34	{ <i>A. barbirostris</i>	3 <i>barbirostris</i>		11.....				
	{ <i>A. rossii</i>	7 <i>rossii</i>						
35	{ <i>A. febrifer</i>	3.....		11.....				
	{ <i>A. maculatus</i>	1 <i>maculatus</i>				1 <i>rossii</i>		1.....
36	<i>A. febrifer</i>	(^a).....						
37	<i>A. barbirostris</i>	8.....		8.....				
38	{ <i>A. rossii</i>	6.....		6.....				
	{ do.....	3 <i>rossii</i>				1.....		1.....
39	{ <i>A. barbirostris</i>	3 <i>barbirostris</i>		6.....				
	{ <i>A. rossii</i>	6 <i>rossii</i>						
40	{ <i>A. barbirostris</i>	1 <i>barbirostris</i>		7.....				
	{ <i>A. rossii</i>	3.....				1 <i>rossii</i>		1.....
41	<i>A. rossii</i>	3.....		3.....				
42 ^a	do.....	4.....		4.....				

44	do	5				
45	do	4	rossii			
46	<i>A. barbirostris</i>	2	barbirostris			
47	<i>A. rossii</i>	2				
48	do		(^a)			
49	<i>A. febrifer</i>		(^a)			
50	<i>A. barbirostris</i>	2	barbirostris			
51	<i>A. rossii</i>	3				66.66
52	do	9				
53	<i>A. febrifer</i>	5				
54	do	35		17		5.71
55	<i>A. rossii</i>	12		5		50.00
56	do	4		2		
57	<i>A. febrifer</i>	1	febrifer			
58	<i>A. barbirostris</i>	1	barbirostris			
59	<i>A. rossii</i>	10		5		20.00
60	do	9				11.11
61	<i>A. febrifer</i>	16				
62	<i>A. barbirostris</i>	4	febrifer			
63	do	14	febrifer			
64	<i>A. maculatus</i>	1	maculatus			
65	do	16				6.25
66	<i>A. maculatus</i>	8				
67	<i>A. febrifer</i>	2	maculatus			
68	<i>A. barbirostris</i>	3	febrifer			
69	do	2	barbirostris			
70	<i>A. rossii</i>	4				16.66
71	do	30		19		
72	<i>A. febrifer</i>	6	febrifer			
73	<i>A. rossii</i>	1	rossii			3.33

^a All of the mosquitoes died before date of dissection.

TABLE II.—Data of all (184) the experiments to infect anopheline mosquitoes with malarial parasites—Continued.

No. of experiment.	Mosquitoes dissected.			Mosquitoes infected.			Per cent of mosquitoes infected (total).
	Species of Anopheles.	Mid-gut.	Salivary glands.	Mid-gut.	Salivary glands.	Total.	
69	{ A. febrifer A. rossii	5 febrifer 3 rossii	2 febrifer 2 rossii	3 febrifer		3	37.50
70	{ A. maculatus	4 maculatus	1 maculatus	1 maculatus		1	20.00
71	{ A. febrifer A. rossii A. maculatus	1 febrifer 5 rossii 5 maculatus	4 febrifer 4 rossii 5 maculatus			10	
72	{ A. rossii A. febrifer	2 rossii 1 febrifer	5 maculatus			3	
73	do	1				1	
74	A. maculatus	3				3	
75	A. rossii	4				4	
76	do	5				5	
77	{ A. maculatus A. febrifer	4 maculatus 1 febrifer	3 maculatus			5	
78	A. rossii	5				5	
79	do	1				1	100.00
80	A. febrifer	(s)					
81	{ A. barbirostris A. rossii	4 barbirostris 1 rossii	4 barbirostris 1 rossii	1 barbirostris		1	20.00
82	{ A. barbirostris A. rossii	12 barbirostris 3 rossii	11 barbirostris 1 rossii	1 febrifer		1	5.5
83	{ A. maculatus A. barbirostris A. rossii A. febrifer	2 febrifer 1 maculatus 11 barbirostris 1 rossii	1 maculatus 7 barbirostris 1 febrifer			1	7.69

84	<i>A. barbirostris</i> <i>A. rossii</i> <i>A. maculatus</i> <i>A. febrifer</i> do	10 <i>barbirostris</i> 4 <i>rossii</i> 1 <i>maculatus</i> 1 <i>febrifer</i> 26	10 <i>barbirostris</i> 2 <i>rossii</i> 1 <i>maculatus</i> 1 <i>febrifer</i> 24	16	1	3.84
85	<i>A. barbirostris</i> <i>A. febrifer</i> <i>A. maculatus</i> <i>A. rossii</i> do	9 <i>barbirostris</i> 4 <i>febrifer</i> 1 <i>maculatus</i> 1 <i>rossii</i> 7	8 <i>barbirostris</i> 4 <i>febrifer</i> 1 <i>maculatus</i> 4	15		
87	do	7	4	7		
88	<i>A. febrifer</i>	8	7	8	1	62.50
89	do	2	2	2	1	100.00
90-91	do	10	5	10	2	30.00
92	do	14	5	14	2	14.28
93	do	6	6	6	3	50.00
94	<i>A. maculatus</i> <i>A. febrifer</i> do	1 <i>maculatus</i> 1 <i>febrifer</i> 17	1 <i>maculatus</i> 1 <i>febrifer</i> 12 <i>rossii</i> 2 <i>febrifer</i> 5	2	1 <i>febrifer</i>	50.00
95	do	17	4	17	6	35.28
96	<i>A. rossii</i> <i>A. febrifer</i> <i>A. rossii</i> do	12 <i>rossii</i> 2 <i>febrifer</i> 5 31	4 <i>rossii</i> 1 <i>febrifer</i> 4	14	4 <i>rossii</i> 1 <i>febrifer</i>	35.35
97	<i>A. rossii</i>	5	4	5	5	
98	do	31	4	31	9	25.80
99	<i>A. febrifer</i> <i>A. barbirostris</i> do	5 <i>febrifer</i> 2 <i>barbirostris</i> 2	5 <i>febrifer</i> 2 <i>barbirostris</i> 2	7	2 <i>febrifer</i>	28.57
101	<i>A. rossii</i>	2	2	2		
102	<i>A. febrifer</i>	2	2	2		
103	do	3 <i>febrifer</i> 1 <i>rossii</i> do	2 <i>febrifer</i> 1 <i>rossii</i> 5	4		
104	do	5	5	5		
105	<i>A. febrifer</i> <i>A. barbirostris</i> <i>A. febrifer</i> <i>A. barbirostris</i>	7 <i>febrifer</i> 1 <i>barbirostris</i> 4 <i>febrifer</i> 1 <i>barbirostris</i>	7 <i>febrifer</i> 1 <i>barbirostris</i> 4 <i>febrifer</i> 1 <i>barbirostris</i>	8	2 <i>febrifer</i>	25.00
106	<i>A. barbirostris</i>	1 <i>barbirostris</i>	1 <i>barbirostris</i>	5		

^a All of the mosquitoes died before date of dissection.

TABLE II.—Data of all (184) the experiments to infect anopheline mosquitoes with malarial parasites—Continued.

No. of experiment.	Species of Anopheles.	Mosquitoes dissected.			Mosquitoes infected.			Per cent of mosquitoes infected (total).
		Mid-gut.	Salivary glands.	Total.	Mid-gut.	Salivary glands.	Total.	
107	<i>A. rossii</i>	3		3				
108	<i>A. febrifer</i>	2		2				
109	<i>A. rossii</i>	(a)						
110	<i>A. febrifer</i>	(a)						
111	do.....	16		16				
112	<i>A. rossii</i>	20		20				
113	do.....	(b)						
114	do.....	(b)						
115	do.....	4		4				
116	do.....	3		3				
117	<i>A. febrifer</i>	8		8				
118	do.....	(b)						
119	<i>A. rossii</i>	7		7				
120	<i>A. febrifer</i>	21 febrifer						
121	<i>A. barbirostris</i>	2 barbirostris		23				
122	<i>A. febrifer</i>	1		1				
123	<i>A. barbirostris</i>	1		1				
124	<i>A. rossii</i>	(a)						
126	<i>A. barbirostris</i>	(a)						
127	do.....	(a)						
128	<i>A. febrifer</i>	1		1				

129	{ A. rossii A. barbirostris	(n)				
130	{ A. febrifer A. barbirostris		23			
131	{ A. febrifer A. rossii A. barbirostris	(c)	3			
132	A. rossii	(c)				
133	A. barbirostris					
134	{ A. febrifer A. barbirostris		8			
135	A. rossii		19			
136	{ A. febrifer A. barbirostris		9			
138	A. febrifer		9			
139	A. rossii	(d)				
140a	{ A. febrifer A. rossii A. barbirostris		18			44.44
146a	{ A. febrifer A. rossii A. barbirostris		12			16.66
146b	{ A. febrifer A. barbirostris		5			100.00
150a	{ A. febrifer A. rossii A. barbirostris		14			35.35
151	{ A. rossii A. barbirostris		4			

^c Blooded females transferred to cage 131.

^d Blooded females transferred to cage 138.

^a All of the mosquitoes died before date of dissection.

^b Combined with cage 115.

TABLE II.—Data of all (184) the experiments to infect anopheline mosquitoes with malarial parasites—Continued.

No. of experiment.	Species of Anopheles.	Mosquitoes dissected.			Mosquitoes infected.			Per cent of mosquitoes infected (total).
		Mid-gut.	Salivary glands.	Total.	Mid-gut.	Salivary glands.	Total.	
152	<i>A. barbirostris</i>	5		5	1		1	20.00
153	{ <i>A. febrifer</i>	{ 3		{ 4	{ 3		{ 3	{ 75.00
154	{ <i>A. rossii</i>	{ 7		{ 7				
155a	{ do	{ 1	{ 1 <i>rossii</i>	{ 4	{ 1 <i>barbirostris</i>		{ 1	{ 25.00
156	{ <i>A. barbirostris</i>	{ 3	{ 3 <i>barbirostris</i>	{ 7			{ 2	{ 28.57
157	{ <i>A. rossii</i>	{ 6		{ 7			{ 7	{ 100.00
158a	{ <i>A. febrifer</i>	{ 7		{ 7				
159	{ <i>A. barbirostris</i>	{ 4		{ 4				
161	{ <i>A. febrifer</i>	{ 13		{ 13			{ 7	{ 54.60
162	{ <i>A. rossii</i>	{ 5		{ 7				
163	{ <i>A. barbirostris</i>	{ 9		{ 9			{ 1	{ 11.11
166a	{ <i>A. febrifer</i>	{ 8		{ 23			{ 2	{ 8.69
170a	{ <i>A. rossii</i>	{ 9		{ 10			{ 2	{ 20.00
172	{ <i>A. barbirostris</i>	{ 2		{ 8			{ 2	{ 25.00
173	{ <i>A. febrifer</i>	{ 8		{ 11				
174	{ <i>A. rossii</i>	{ 10		{ 14				
175	{ <i>A. barbirostris</i>	{ 14		{ 17			{ 13	{ 76.74
176	{ <i>A. febrifer</i>	{ 17		{ 11			{ 1	{ 9.09
177	{ <i>A. rossii</i>	{ 11		{ 12				
	{ <i>A. barbirostris</i>	{ 7						

178	<i>A. febrifer</i>	5 febrifer	3 febrifer	1 febrifer	6	6	100.00
	<i>A. maculatus</i>	1 maculatus	1 maculatus	1 maculatus			
179	<i>A. febrifer</i>	5 febrifer	5 febrifer	5 febrifer	6	5	83.33
	<i>A. maculatus</i>	1 maculatus	1 maculatus				
181	<i>A. febrifer</i>	5 febrifer	4 febrifer	4 febrifer	6	6	100.00
	<i>A. maculatus</i>	1 maculatus	1 maculatus	2 febrifer			
182	<i>A. rossii</i>	6	5		6		
183	<i>A. febrifer</i>	2 febrifer	2 febrifer		4	1	25.00
	<i>A. barbirostris</i>	2 barbirostris	2 barbirostris	1 febrifer			
184	<i>A. rossii</i>	1	1		1		
185	<i>A. barbirostris</i>	(*)					
186a	<i>A. febrifer</i>	5 febrifer	5 febrifer	2 febrifer	9	3	33.33
	<i>A. rossii</i>	4 rossii	4 rossii				
189a	<i>A. febrifer</i>	3 febrifer	3 febrifer	1 febrifer	22	1	4.64
	<i>A. rossii</i>	18 rossii	17 rossii				
	<i>A. barbirostris</i>	1 barbirostris	1 barbirostris		13	7	70.00
191	<i>A. febrifer</i>	10	3				
	do	2 febrifer			12	2	16.66
192	<i>A. rossii</i>	9 rossii					
	<i>A. barbirostris</i>	1 barbirostris					
194a	<i>A. febrifer</i>	4 febrifer			8		
	<i>A. rossii</i>	3 rossii					
	<i>A. barbirostris</i>	1 barbirostris					
199	<i>A. sinensis</i>	(*)					
200a	<i>A. febrifer</i>	3 febrifer	3 febrifer	1 febrifer	4	2	50.00
	<i>A. barbirostris</i>	1 barbirostris	1 barbirostris				
202	<i>A. rossii</i>	1			1		
204	<i>A. sinensis</i>	6			6		
205a	<i>A. rossii</i>	1 barbirostris			1		
	<i>A. barbirostris</i>						
207a	<i>A. rossii</i>	3 rossii			6	2	33.33
	<i>A. barbirostris</i>	3 barbirostris					
211	<i>A. sinensis</i>	5			5		

* Cage 185 became infected with ants which destroyed all of the mosquitoes.

TABLE II.—Data of all (184) the experiments to infect anopheline mosquitoes with malarial parasites—Continued.

No. of experiment.	Species of <i>Anopheles</i> .	Mosquitoes dissected.			Mosquitoes infected.			Per cent of mosquitoes infected (total).
		Mid-gut.	Salivary glands.	Total.	Mid-gut.	Salivary glands.	Total.	
212	<i>A. febrifer</i>	3 <i>febrifer</i>		9	3 <i>febrifer</i>		3	33.33
	<i>A. rossii</i>	2 <i>rossii</i>						
	<i>A. barbirostris</i>	4 <i>barbirostris</i>						
	<i>A. sinensis</i>	6.....		6				
216	<i>A. febrifer</i>	4 <i>febrifer</i>		9	4 <i>febrifer</i>		4	44.44
	<i>A. barbirostris</i>	5 <i>barbirostris</i>						
	<i>A. febrifer</i>	1 <i>febrifer</i>		8	1 <i>febrifer</i>		6	
219	<i>A. rossii</i>	7 <i>rossii</i>		8	5 <i>rossii</i>		6	75.00
	<i>A. febrifer</i>	8 <i>febrifer</i>		10	7 <i>febrifer</i>		8	
220	<i>A. rossii</i>	1 <i>rossii</i>		10	1 <i>rossii</i>		4	80.00
	<i>A. barbirostris</i>	1 <i>barbirostris</i>		5	4 <i>rossii</i>		4	
	<i>A. rossii</i>	4 <i>rossii</i>		5				
221a	<i>A. sinensis</i>	1 <i>sinensis</i>		12	1 <i>febrifer</i>		6	50.00
	<i>A. febrifer</i>	1 <i>febrifer</i>		1	5 <i>rossii</i>			
224	<i>A. rossii</i>	11 <i>rossii</i>		1				
	do	1 <i>rossii</i>						
227a	<i>A. barbirostris</i>							

In the text and tables that follow, the details of these experiments are discussed at length under appropriate headings.

THE DEVELOPMENT OF ANOPHELINE LARVÆ IN CAPTIVITY

The rearing of adult anopheline mosquitoes from mature or nearly mature larvæ and from pupæ in the laboratory presents no difficulties, as the majority of them live to emerge as imagoes within a few days; on the other hand, large numbers of the younger larvæ fail to develop and die in the breeding jars. This is possibly due in part to the stagnant condition of the water in the breeding jars and in part to the lack of proper food. The water in our breeding jars was aerated daily, as recommended by Darling (1910), and no difficulty was experienced with foulness of the water due to the development of anaërobic bacteria. In collecting larvæ, more or less of their natural food was undoubtedly included, and in many cases algæ, pond weeds, or débris, in which the larvæ were found, were added to the breeding jars. Duck weed, which in some cases was found associated with the larvæ in nature, when added to the breeding jars quickly overgrows the surface of the water and prevents the larvæ from coming to the surface for air. It is probable that the development of a larger proportion of the younger larvæ would be secured if they could be bred in the tanks furnished with running water and supplied with an abundance of natural food. In practice it was found best to collect, so far as possible, the larger larvæ and pupæ.

PROPORTION OF FEMALES TO MALES IN ANOPHELINES BRED FROM LARVÆ IN CAPTIVITY

This is best shown in a table constructed from the data of those experiments in which the males and females were separated and counted. The counts were made of the mosquitoes after feeding on the malaria patient in the cages in which they were collected from the breeding jars, and include the dead as well as living mosquitoes. They are, therefore, approximately accurate.

TABLE III.—Proportion of females to males in anophelines bred from larvæ.

Species.	Lots of mosquitoes.	Males.	Females.	Females.
				<i>Per cent.</i>
<i>Anopheles febrifer</i>	35	697	812	53.8
<i>Anopheles rossii</i>	37	787	1,073	57.6
<i>Anopheles barbirostris</i>	23	206	289	58.3
<i>Anopheles sinensis</i>	4	96	143	59.8
<i>Anopheles maculatus</i>	1	3	2	40.0
Total	100	1,789	2,319	56.4

From this table it is apparent that the females outnumbered the males in every species but *Anopheles maculatus*. However, in this species the number of mosquitoes is too few to draw any conclusions. Authors have sometimes complained of a preponderance of males among mosquitoes bred from larvæ in the laboratory, and it has been supposed that this preponderance was due to lack of sufficient food in the breeding jars. As Table III shows, we have not experienced this difficulty; in our lots of laboratory-bred mosquitoes of 5 species, the males and females have varied more or less in the different lots as is to be expected, but on the whole there has been a slight preponderance of females.

THE LONGEVITY OF ANOPHELINES IN CAPTIVITY

We have succeeded in keeping a fair proportion of our mosquitoes alive from five to eighteen days, a time sufficient for the development of the malarial parasite to the oöcyst or sporozoite stages. The different cages of mosquitoes showed considerable variation in this respect, even in the case of the same species, reared and kept under apparently the same conditions. At the beginning of our investigation, during the cool season, but little difficulty was experienced in maintaining a fair proportion of mosquitoes alive to the time of dissection. As the hot season approached, the mortality occurring among our experimental mosquitoes increased. The use of wet cotton and filter paper as a bottom for our cages was therefore discarded, and after experimenting with moist earth and other materials moist sand was finally substituted, which proved successful in maintaining the life of the mosquitoes in captivity. Undoubtedly, if our mosquitoes had received unlimited personal attention, a larger proportion would have survived, but owing to the pressure of work the care of them had to be intrusted to the laboratory boy, who was also overworked and necessarily neglected them at times. Experiments 95 to 227a, in which both the number of mosquitoes that fed on blood and the number that lived to be dissected were determined, supply the following data bearing on this question. In all cases the mosquitoes had emerged from twenty-four to forty-eight hours before biting, and were consequently from 1 to 2 days old when the experiment began.

TABLE IV.—The longevity of anophelines in captivity.

Interval in days between blood meal and dissection.	Mosquitoes at beginning of experiment.	Mosquitoes surviving at date of dissection.	Mosquitoes that survived and were dissected.
			<i>Per cent.</i>
5	11	9	81.8
6	158	121	76.5
7	139	69	49.6
8	188	80	42.5
9	298	151	50.6
10	100	47	47.0
11	112	32	28.5
12	120	64	53.3
13	32	19	59.3
14	17	8	47.0
15	54	17	31.4
16	24	14	58.3
18	33	8	21.0
No record	11	0	0
Total	1,302	639	49.0

Therefore, on the average, about one-half of our experimental mosquitoes lived to be dissected. The proportion that lived to the date of dissection, so far as the differential counts of both the females that sucked blood and the females that lived to be dissected were made, show the following distribution among the several species:

TABLE V.—Longevity of the several species in captivity.

Species.	Females that sucked blood.	Females alive at dissection.	Females living to be dissected.
			<i>Per cent.</i>
<i>Anopheles febrifer</i>	398	219	55.0
<i>Anopheles rossii</i>	523	221	42.2
<i>Anopheles barbirostris</i>	221	137	61.9
<i>Anopheles sinensis</i>	23	18	78.2
<i>Anopheles maculatus</i>	2	2	100.0

In this table are included all of the mosquitoes that lived to be dissected without reference to the length of time that they survived. The time intervening between the date that the mosquitoes fed on infected blood and the date they were dissected probably averages nearly equal in the several species.

The data are probably approximately accurate for the first 3 species, but in the last 2 the numbers are too small for the percentages to be reliable.

THE AVIDITY OF THE SEVERAL SPECIES OF ANOPHELINES FOR HUMAN BLOOD

In experiments 1 to 94, inclusive, the females which contained blood were not separated from the empty females and males after feeding on infected blood; the mosquitoes in this series were usually given two or more opportunities to feed on the malarial patient on successive days. It is, therefore, impossible to say what proportion of the mosquitoes in this series fed on the infected blood at any one time. In experiments 95 to 227a, inclusive, the mosquitoes, which were given an opportunity to bite the infected patient only once, were immediately removed individually from the biting cages in test tubes and examined with a hand lens. The females containing blood were separated from the empty females and the males, and were placed in a separate cage which was given the experiment number. The number of females containing blood, empty females, and males were, in most cases, recorded in this series of experiments. In Table VI are given the results of these differential counts, classified according to the species of Anophelinae. Some of these mosquitoes were fed on the malarial patient within twenty-four hours, others not until the second day after emergence. In the latter case, all food was usually withheld from the mosquitoes until they were fed on the malarial patient.

TABLE VI.—*The proportion of the different species of anophelines taking a meal of blood when given one opportunity.*

Species.	Total females.	Females containing blood.	Empty females.	Taking a meal of blood.
				<i>Per cent.</i>
<i>Anopheles febrifer</i>	696	382	314	54.8
<i>Anopheles rossii</i>	936	596	340	63.6
<i>Anopheles barbirostris</i>	273	135	138	49.4
<i>Anopheles sinensis</i>	59	40	19	67.8
<i>Anopheles maculatus</i>	2	1	1	50.0
Total.....	1,966	1,154	812	58.69

From these data it appears that, as a whole, slightly over half of our mosquitoes took a meal of human blood when given one opportunity from twelve to forty-eight hours after emerging from the pupæ. In some instances the mosquitoes bit well on

the same day that they emerged, but in general they bit better on the second day after emergence. With reference to the several species, while the differences are not pronounced, *Anopheles sinensis* shows the largest percentage of individuals taking a meal of blood, followed in order by *Anopheles rossii*, *Anopheles febrifer*, *Anopheles maculatus*, and *Anopheles barbirostris*.

MALARIA PATIENTS USED TO INFECT THE MOSQUITOES

Seventeen different malaria patients whose blood contained gametes were used for infecting the mosquitoes in our experiments. Of these, 8 were suffering with subtertian, 7 with tertian, and 2 with quartan malaria. More experiments were made with subtertian malaria, because this type was most frequently met with and because the gametes persist in subtertian malaria, while they quickly disappear from the blood in tertian malaria, especially if the patient is on quinine treatment. Quartan malaria was found only rarely, and consequently only a few infection experiments were performed with this type of malaria. Thirteen of the patients were Filipinos, of whom 11 were males and 2 females; and 4 were Japanese, all males. The number of cages of mosquitoes fed on one patient varied from 1 to 32, and depended upon the persistence of the gametes in the blood and the ability to keep the patient in our service.

NUMBER OF FEEDINGS ON INFECTED BLOOD

The mosquitoes were allowed to feed from 1 to 6 times on the infected patient in the different experiments. In the earlier experiments the number of feedings depended upon the supply of mosquitoes and the availability of a gamete carrier; in experiments 95 to 227a, the mosquitoes were fed only once, when those containing blood were separated from the empty females and males. It is probable that a greater number of feedings on infected blood would increase the proportion of infections; but in these later experiments it was our purpose to obtain comparable results, and this was possible only under uniform conditions of experimentation.

THE GAMETE COUNT IN MALARIA PATIENTS USED IN THE EXPERIMENTS

In experiments 1 to 10, 17 to 19, and 29 to 33, the gametes were not counted but were estimated as +, ++, +++; in experiments 11 to 16, 20 to 28, and 34 to 55, inclusive, a differential count of gametes and leucocytes was made in thin blood smears, from 200 to 600 leucocytes being counted; in experiments 56 to 227a, the differential counts of gametes and leuco-

cytes were made in thick blood smears, from 1,500 to 3,000 leucocytes being counted. In every case the gamete count is expressed in percentage of the leucocytes in the blood, and the counts were made from blood preparations made at the time the mosquitoes were fed on the patient.

The counts range from 0.6 to 87.0 per hundred leucocytes. This would equal approximately from 42 to 6,090 gametes to 1 cubic millimeter of blood, basing the estimate on an average of 7,000 leucocytes per cubic millimeter of blood. In all cases this would be well within the limits of infectiousness for the mosquitoes as estimated by Darling (1910). In three experiments (50, 51, and 53), owing to the fact that the mosquitoes were fed on the patient at the same time that the blood specimens were taken and before the gamete counts were made, it was found that the gametes had disappeared from the blood. However, in two of these experiments the mosquitoes had previously been fed on the same patient when his blood contained gametes.

The gametes being the only stage of the malarial parasite capable of infecting the mosquitoes, it would be supposed that the percentage of infections, or at least the intensity of the infections, would vary with the number of gametes in the infected blood on which the mosquitoes fed. In Table VII are given the percentage of infections and the average number of oöcysts to an infected mosquito, classified according to the gamete count of the patient on which the mosquitoes fed. In this table are included all of the mosquitoes dissected.

TABLE VII.—Relation between the number of gametes in the blood and the percentage and intensity of infection of the mosquitoes.

Gametes in the malarial blood.	Mosquitoes dissected.	Mosquitoes infected.	Total oöcysts in mid-gut of infected mosquitoes.	Infected mosquitoes.	Average oöcysts to an infected mosquito. ^a
				<i>Per cent.</i>	
0-5 per cent -----	556	86	494	15.5	5.7
5-10 per cent -----	364	45	329	12.3	7.3
10-15 per cent -----	105	12	39	11.4	3.2
15-20 per cent -----	5	5	185	100.0	37.0
20-25 per cent -----	27	18	622	66.6	35.1
25-30 per cent -----	23	10	200	43.4	20.0
30-35 per cent -----	32	6	153	18.7	25.5
75-80 per cent -----	22	9	196	40.9	21.7
80-90 per cent -----	22	1	4	4.5	4.0
No record -----	135	5	11	3.7	2.2

^a In the first and third numbers in this column, in 4 and 6 of the mosquitoes, respectively, the salivary glands only were infected at the time of dissection. Each of these was recorded as having 1 oöcyst in the mid-gut, but it may have had more.

From this table it is apparent that given a malarial patient whose blood contains gametes above the limits of infectiousness, the percentage of infections and the intensity of infections do not depend alone upon the number of gametes ingested, but some other factors must be involved in their determination.

James (1902) calls attention to the question of the maturity of the gametes as bearing on the infectiveness of the blood for the mosquito. He believes that the maturity of the gametes should be determined at the time of every infection experiment, by drawing some of the patient's blood on a microscopical slide under conditions that induce exflagellation of the microgametocytes in order to estimate the proportion of the mature gametes. We have not attempted this, believing that if the blood contained gametes in number well above the limits of infectiousness at least a part of them would be mature. Variations in the maturity of the gametes may be one of the factors that would account for the irregularities in Table VII.

THE AMOUNT OF QUININE ADMINISTERED TO THE MALARIAL PATIENTS USED IN OUR EXPERIMENTS AND ITS EFFECT ON THE INFECTION OF THE MOSQUITOES

Darling (1910) states that in his experiments the routine ward treatment with quinine, grains 10 ter in die, in solution apparently had no effect on the parasites and their development in the gut of the mosquito. However, he cites one experiment in which the patient had received no quinine for several days before the mosquitoes were fed and none during the experiment. In this experiment, one mosquito of the very susceptible species, *Anopheles albimanus*, showed a very large number (168) of zygotes in its mid-gut and 2 mosquitoes of the very unsusceptible species, *Anopheles pseudopunctipennis*, became infected. Therefore, he thinks that quinine may have a slight inhibitory effect on the parasite in the mid-gut of the mosquito. It would seem possible, although the gametes of the malarial parasite are resistant to quinine, that if the patient was saturated with the drug sufficient free quinine might be taken up with the blood into the stomach of the mosquito to injure or kill the delicate microgametes or the zygotes developed in the gut of the mosquito.

In Table VIII are given the total amounts of quinine received by each of the patients during the period they were used in our experiments, the average amount per day, the percentage of infected mosquitoes obtained, and the average number of oöcysts in the mid-guts of the infected mosquitoes in each case. The quinine was administered in the hospital, except in the

cases mentioned in the footnote, and consequently the patients are known to have received the doses stated in the table.

TABLE VIII.—*Effect of quinine treatment on infection of anophelines with malarial parasites.*

No. of patient.	Days used for experiments.	Quinine by mouth during experiments.	Quinine intravenously during experiments.	Average quinine per day during experiments.	Mosquitoes dissected that fed on patient.	Mosquitoes infected.		Average oöcysts to an infected mosquito.
		Grams.	Grams.	Grams.		Number.	Per cent.	
808	17	5.83	9.0	0.85	60	0	0	0
1251	6	0.64	7.2	1.3	3	0	0	0
1372	3	0	0.9	0.3	-----	0	0	0
1413	3	0.97	0.9	0.62	22	1	4.54	1.0
1261	13	5.18	9.0	1.09	82	5	6.09	37.0
1486	3	0	0	0	12	0	0	0
1506	2	0	0	0	12	1	8.3	3.0
1345	2	0	0	0	21	2	9.5	3.0
223	22	6.80	10.8	0.8	271	21	7.7	11.5
1240	3	2.59	0	0.86	15	1	6.6	1.0
1548	3	(a)	1.8	0.6?	19	2	10.5	2.5
1612	16	0.97	0	0.06	256	46	17.9	^b 3.09
1197	6	9.7	0	1.62	96	0	0	0
1659	6	1.29	0.9	0.44	57	0	0	0
1312	5	^c 4.86	0	0.97	252	74	29.3	^b 5.7
1786	2	0	0	0	44	10	22.7	20.0
1806	7	9.07	0	1.29	83	34	40.9	28.8

^a Given quinine to take at home.

^b Several of the infected mosquitoes had only sporozoites in their salivary glands; therefore, they had at least 1 oöcyst in the mid-gut and possibly more.

^c Given quinine to take at home. The patient said that he took the amount stated.

From these data it does not appear that the quantity of quinine taken by the patient during the time he was used for infection experiments had any influence upon the percentage or intensity of infections of the mosquitoes.

NUMBER OF EXPERIMENTS

Anopheline mosquitoes, bred from larvæ, distributed among 227 cages were fed on malaria patients whose blood contained gametes of the malarial parasite. Some of these cages were combined, after the mosquitoes had fed, to form the 184 experiments recorded in Table I. In our earlier experiments our technique was not fully developed, difficulties in keeping the mosquitoes alive were encountered, and the results were not quantitative; later our technique was improved, the difficulties were overcome, and the experiments were made to yield quantitative results. It has, however, been considered advisable to include all of our experiments, the failures as well as the successes,

in our report. This will indicate better the reliability of our work, and will be helpful to others who may undertake similar investigations.

Of these 184 experiments, 79 were with *Anopheles febrifer*, 117 with *Anopheles rossii*, 59 with *Anopheles barbirostris*, 5 with *Anopheles sinensis*, and 19 with *Anopheles maculatus*. Each cage contained a variable number of mosquitoes, and many of the cages contained two or more species, just as they had emerged from the larvæ collected in one locality.

NUMBER OF MOSQUITOES DISSECTED

In the 184 experiments, 1,287 lived to be dissected for the presence of oöcysts in their mid-guts; of these, the salivary glands were also dissected in 316 for the presence of sporozoites although as shown in Table V about 50 per cent of the mosquitoes died during the course of the experiments. These totals are distributed among the several species as follows:

TABLE IX.—Distribution of the dissected mosquitoes among the several species.

Species.	Mid-guts dissected.	Salivary glands dissected.
<i>Anopheles febrifer</i>	373	93
<i>Anopheles rossii</i>	642	129
<i>Anopheles barbirostris</i>	205	70
<i>Anopheles sinensis</i>	18	0
<i>Anopheles maculatus</i>	49	24
Total	1,287	316

DEVELOPMENT OF OVA IN THE EXPERIMENTAL MOSQUITOES

Of the 1,287 female anopheline mosquitoes dissected, the ova were developed in 73, not developed in 1,139, and not recorded in 75. As in the case of the mosquitoes in cages 95 to 227a the females were separated from the males shortly after emerging, it is fairer to exclude these from consideration, as the opportunity for copulation was greatly reduced. Of the 630 females dissected from these cages only 26 showed development of the ova. In the remaining cages, 1 to 94, the males remained with the females up to the time of dissection. Six hundred fifty-seven females were dissected from these cages, of which the ova were developed in 47 and not developed in 492. No record was taken of the remainder. The distribution of the females having ova developed among the several species is shown in Table X.

TABLE X.—Development of ova in the experimental mosquitoes.

Species.	Ova developed.	Ova not developed.	Percentage having ova developed.
<i>Anopheles febrifer</i>	9	381	2.3
<i>Anopheles rossii</i>	17	541	3.1
<i>Anopheles barbirostris</i>	43	154	27.9
<i>Anopheles sinensis</i>	0	18	0
<i>Anopheles maculatus</i>	4	45	8.0
Total	73	1,139	6.4

Annett, Dutton, and Elliott (1901) performed a number of experiments on the relation between a blood meal and the development of ova in anopheline mosquitoes; and from these experiments they came to the conclusion that a blood meal was necessary for the development of ova in the female. It would seem that the converse of this might be true; that every female which had a blood meal and copulated with a male would develop ova. It was hoped that the presence of developed ova might supply an index of whether or not the mosquito had bitten a patient and sucked blood, but this does not appear to be the case.

PERCENTAGE OF INFECTED MOSQUITOES

Of the total 1,287 female anopheline mosquitoes dissected after having had one or more opportunities of taking a meal of blood containing gametes, 205, or 15.92 per cent, contained oöcysts in their mid-guts, or sporozoites in their salivary glands, or both oöcysts and sporozoites, depending upon the time elapsing between the date of feeding and the date of dissection. Of the 205 infected mosquitoes, 189 contained oöcysts in their mid-guts in various stages of development, and 28 showed sporozoites in their salivary glands. In experiments 1 to 94, the females containing blood were not separated from the empty females and it was impossible to make any differentiation at the time of dissection, but in experiments 95 to 227a only the females containing blood were dissected; in this series the proportion of infected females should be considered separately. Furthermore, a still more reliable comparison of the infections in the several species will be obtained by considering separately certain parallel experiments in which the different species of mosquitoes were fed at the same time on the same patient, in which the females containing blood were separated, and in

which at least one mosquito in the series became infected. The fact that one mosquito in such a series became infected proved that the gametes were capable of infecting. In Table XI are given the total infections and the infections grouped according to the above divisions, classified by species.

TABLE XI.—Percentage of infected mosquitoes.

	<i>A. febrifer.</i>	<i>A. rossii.</i>	<i>A. barbrostris.</i>	<i>A. sinensis.</i>	<i>A. maculatus.</i>	Total.
Total dissected	373	642	205	18	49	1,287
Total infected:						
Number	132	63	7	0	3	205
Per cent	35.38	9.81	3.41	0	6.12	15.92
Blooded females not separated from empty females:						
Dissected	138	330	93	0	46	657
Infected—						
Number	24	28	1	0	1	54
Per cent	17.39	7.36	1.07	0	2.17	8.21
Blooded females only:						
Dissected	235	262	112	18	3	630
Infected—						
Number	108	35	6	0	2	151
Per cent	45.95	13.35	5.35	0	66.66	23.96
Strictly comparative experiments:						
Dissected	162	187	100	12	3	464
Infected—						
Number	108	35	6	0	2	151
Per cent	66.66	18.71	6.0	0	66.66	32.54

In the last section of Table XI, the experiments with the several species are strictly comparable and the results give a more accurate measure of the susceptibility of the first three species. In the last two species the number of individuals included in the data is insufficient to draw reliable conclusions.

In 1910 de Vogel was able to infect "*Myzomyia rossii*" breeding in brackish or salt water, but not those breeding in fresh water. Banks (1907) also obtained infections of "*Myzomyia ludlowi*" breeding in brackish and salt water, but he made no experiments with those breeding in fresh water. As our experiments were made with *Anopheles rossii* breeding in both fresh and salt water, it is interesting to compare the susceptibility of the mosquitoes from the two sources. Five hundred ninety-five specimens of *Anopheles rossii* breeding in fresh water were dissected, of which 58, or 9.74 per cent, were infected; 42 specimens of *Anopheles rossii* which were bred in salt water were dissected, of which 5, or 10.63 per cent, were infected. There-

fore, while much fewer of the salt water forms were dissected, the percentage of infections in the mosquitoes from the two sources was practically the same.

INFECTIONS WITH THE DIFFERENT SPECIES OF MALARIAL PARASITES

The number and percentage of infections obtained with the parasites of subtertian, tertian, and quartan malaria in the different species of anophelines are given in Table XII.

TABLE XII.—Infections with the different species of malarial parasites.

Species.	<i>A. febrifer.</i>	<i>A. rossii.</i>	<i>A. barbrostris.</i>	<i>A. sinensis.</i>	<i>A. maculatus.</i>	Total.
<i>Plasmodium præcox (falciparum):</i>						
Experiments	66	91	48	5	13	228
Mosquitoes dissected	320	546	181	18	45	1,110
Mosquitoes infected—						
Number	132	57	7	0	3	199
Per cent	41.25	10.43	3.86	0	6.66	17.92
<i>Plasmodium vivax:</i>						
Experiments	3	17	5	0	1	26
Mosquitoes dissected	13	75	11	0	4	103
Mosquitoes infected—						
Number	0	6	0	0	0	6
Per cent	0	8.00	0	0	0	5.82
<i>Plasmodium malariae:</i>						
Experiments	9	8	7	0	0	24
Mosquitoes dissected	40	21	13	0	0	74
Mosquitoes infected—						
Number	0	0	0	0	0	0
Per cent	0	0	0	0	0	0

In this table the total number of experiments with the several species of mosquitoes exceeds the number of experiments recorded in Table II because many of the cages contained more than one species of mosquito. While nearly as many patients with tertian (7) as with subtertian (8) malaria were used in our experiments, a much smaller number of experiments was made and mosquitoes dissected in the case of the tertian type of malaria. This is due chiefly to the fact that the gametes are much less persistent in tertian than in subtertian malaria. In the case of quartan malaria only two patients were available for experimentation. Moreover, both the tertian and the quartan patients happened to be available either early in our investigation before our technique was well developed or during the time when unusual mortality was occurring among our mosquitoes. Therefore, our data with reference to infections with the tertian and quartan parasites are not so complete as desired.

INFECTION OF THE SALIVARY GLANDS

Of the 332 mosquitoes in which the salivary glands were dissected out for the determination of infection, 21, or 6.32 per cent, contained sporozoites. The total percentage of infected salivary glands is of no particular significance, as it depends upon the time elapsing between the meal of infective blood and the date of dissection and upon the species of anopheline. Therefore, the distribution of the mosquitoes dissected for the salivary glands and the percentages infected are classified in Table XIII according to the species and to the time of development.

TABLE XIII.—Infected salivary glands.

Species.	Days after infective feeding.								Total.
	10	11	12	13	14	15	16	18	
<i>Anopheles febrifer</i> :									
Dissected	0	8	21	14	5	15	37	11	111
Infected—									
Number	0	0	3	3	0	2	6	6	20
Per cent	0	0	14.28	21.42	0	13.33	16.21	54.54	18.01
<i>Anopheles rossii</i> :									
Dissected	7	6	32	54	8	10	2	6	125
Infected—									
Number	0	0	0	0	0	0	0	0	0
Per cent	0	0	0	0	0	0	0	0	0
<i>Anopheles barbirostris</i> :									
Dissected	0	7	13	1	13	22	16	3	75
Infected—									
Number	0	0	0	0	0	0	0	0	0
Per cent	0	0	0	0	0	0	0	0	0
<i>Anopheles sinensis</i> :									
Dissected	0	0	0	0	0	0	0	0	0
Infected—									
Number	0	0	0	0	0	0	0	0	0
Per cent	0	0	0	0	0	0	0	0	0
<i>Anopheles maculatus</i> :									
Dissected	4	4	1	6	2	4	0	0	21
Infected—									
Number	0	0	1	0	0	0	0	0	1
Per cent	0	0	100.00	0	0	0	0	0	4.76

The earliest day after the infective meal of blood that sporozoites were found in the salivary glands was the twelfth, in both *Anopheles febrifer* and in *Anopheles maculatus* infected with *Plasmodium præcox* (*falciparum*), the parasite of subtertian malaria. These infections were found during the warm season; in the cool season the period of development of the

subtertian parasite up to the infection of the salivary glands of the mosquito appeared to be slightly longer—from thirteen to fifteen days. No infected salivary glands were found among the mosquitoes dissected that had fed on the blood of patients infected with tertian or quartan malaria. For comparison with these results it is interesting to note that Darling (1910) found sporozoites of the tertian parasite after eleven and one-half days and of the subtertian parasite after eleven days in the salivary glands of *Anopheles (Celia) albimanus* in the Panama Canal Zone.

It is noteworthy that, while 18.01 per cent of 111 *Anopheles febrifer* dissected between the tenth and eighteenth days after the infective meal showed sporozoites in the salivary glands, none of the 125 *Anopheles rossii* dissected during the same periods after the infective meal showed sporozoites in the salivary glands. However, oöcysts containing sporozoites were found repeatedly in infected *Anopheles rossii*.

IV. SUMMARY AND CONCLUSIONS

Number of experiments, 184.	Number of mosquitoes infected, 205.
With subtertian malaria, 134.	Mid-guts, 189.
With tertian malaria, 26.	Salivary glands, 28.
With quartan malaria, 24.	<i>Anopheles febrifer</i> , 132.
With <i>Anopheles febrifer</i> , 79.	<i>Anopheles rossii</i> , 63.
With <i>Anopheles rossii</i> , 117.	<i>Anopheles barbirostris</i> , 7.
With <i>Anopheles barbirostris</i> , 59.	<i>Anopheles sinensis</i> , 0.
With <i>Anopheles sinensis</i> , 5.	<i>Anopheles maculatus</i> , 3.
With <i>Anopheles maculatus</i> , 19.	Percentage of total mosquitoes in-
Number of malaria patients used, 17.	fected, 15.92.
Subtertian, 8.	<i>Anopheles febrifer</i> , 35.38.
Tertian, 7.	<i>Anopheles rossii</i> , 9.81.
Quartan, 2.	<i>Anopheles barbirostris</i> , 3.41.
Gamete counts (percentage of leuco-	<i>Anopheles sinensis</i> , 0.
cytes), 0.6 to 87.0	<i>Anopheles maculatus</i> , 6.12.
Number of mosquitoes dissected, 1,287.	Percentage of mosquitoes infected in
Mid-guts, 1,287.	the strictly comparative experi-
Salivary glands, 316.	ments, 32.54.
<i>Anopheles febrifer</i> , 373.	<i>Anopheles febrifer</i> , 66.66.
<i>Anopheles rossii</i> , 642.	<i>Anopheles rossii</i> , 18.71.
<i>Anopheles barbirostris</i> , 205.	<i>Anopheles barbirostris</i> , 6.00.
<i>Anopheles sinensis</i> , 18.	<i>Anopheles sinensis</i> , 0.
<i>Anopheles maculatus</i> , 49.	<i>Anopheles maculatus</i> , 66.66.

The results of these experiments show that *Anopheles febrifer* is probably, among the anopheline mosquito in the Philippine Islands, the most susceptible to infection with the parasites of subtertian malaria. While the number of experiments with

tertian and quartan malaria is insufficient to determine the fact, it is probable that this species is also an efficient carrier of these types of the disease. This species is from three to four times as susceptible as *Anopheles rossii*, which has hitherto been considered the malaria carrier of the Philippines, and eleven times as susceptible as *Anopheles barbirostris*.

The number of mosquitoes of the species *Anopheles sinensis* and *Anopheles maculatus* dissected, especially in the comparative experiments, is too small to give reliable percentages. It is possible that a larger series of experiments with *Anopheles sinensis* would show that this species can be infected. Its susceptibility, however, is probably feeble. We believe it to be the least susceptible of the five species with which we experimented. The percentage, 66.66, of infections of *Anopheles maculatus* in the comparative experiments was obtained with only 3 specimens, and is probably too high; that of 6.12 in the total experiments is probably too low. We are of the opinion that the susceptibility of this species is at least as high as that of *Anopheles rossii*, and probably lies between that of the latter species and that of *Anopheles febrifer*.

The rôle played by a species of *Anopheles* in the transmission of malaria in any country depends chiefly upon (1) its susceptibility and (2) its geographical distribution and prevalence; also, to some extent, upon (3) its avidity for human blood and (4) its domesticity.

Of these factors susceptibility is of fundamental importance. It is obvious that a mosquito which is immune or only slightly susceptible to infection with the malarial parasite will, no matter how prevalent or widely distributed, be of little or no importance in the transmission of malaria; on the other hand, a very susceptible species may, although less prevalent, play a leading rôle in the spread of this disease. For example, *Anopheles rossii* was collected in native houses in certain regions in India by Stephens and Christophers and others in far larger numbers than was *Anopheles culicifacies*; but, while the latter species was found naturally infected with malarial parasites to the extent of from 4 to 16 per cent, not a single *Anopheles rossii* was found infected. These authors, therefore, concluded that *Anopheles rossii*, although more prevalent, played a subordinate, while the less plentiful *Anopheles culicifacies* played the chief, rôle in the transmission of malaria in these regions.

A species that was rare or limited to certain regions or altitudes might, although very susceptible, be of little importance in the dissemination of malaria in a country as a whole. A

species, like *Anopheles ludlowii*, which breeds for the most part near the sea coast, would be of little importance in an inland country; *Anopheles maculatus*, which is chiefly a mosquito of high altitudes, would be unimportant in a lowland country; and an anopheline that is not more or less adaptable to various conditions and altitudes would play a lesser rôle in the transmission of malaria in a country of varied topography, vegetation, and altitudes. An anopheline must not only be susceptible, but it must be of wide distribution and prevalence to be of prime importance in the epidemiology of malaria in any country.

Anophelines vary widely in their avidity for human blood. Schüffner (1902) was unable to make any individuals of one species with which he experimented bite and suck the blood of man; on the other hand, another species exhibited an intense voracity for human blood. It is obvious that an anopheline which has a strong inclination to seek and bite man will, other things being equal, be more apt to transmit malaria than a species which has less avidity for human blood.

Certain species of Anophelinæ, like *Anopheles rossii*, may be called domestic species, although not to the extent of *Stegomyia calopus* or some species of the genus *Culex*, in that they breed in the open near human habitations; other species, like those of the *Myzorhynchus* group, may be termed wild mosquitoes, in the sense that they breed in and frequent the forest. Other things being equal, it is probable that the more domestic species would be the more important in the transmission of malaria, because of the greater opportunity offered to them to bite and suck the blood of malarial and healthy persons. However, in most tropical countries, especially outside of the cities, the importance of this factor would be more or less neutralized by the habits and customs of the natives. The natives of most tropical countries build their houses in or about the borders of the forest and near water, usually along the banks of the jungle streams, for the purpose of shade and other protection which the forest offers and in order to be near a supply of water. It is the custom, at least in the Philippines, for the natives to wash their clothes and to bathe in these jungle streams and also to carry water from them, often in the early morning or evening. There is thus every opportunity for these people to be bitten by the forest-loving anophelines that abound there.

Much more work must be done, especially on the distribution and prevalence of the Philippine Anophelinæ, before the rôle of the different species in the epidemiology of malaria in the

Philippine Islands can be accurately determined. These aspects of the problem are now being investigated by one of us (Barber), and already interesting and important results have been obtained, which will be published later. However, the importance of the 5 species of Anophelinæ, investigated in the transmission of malaria in the Philippines, can be roughly estimated as follows:

Anopheles maculatus is probably a moderately susceptible, semiwild species, with a moderate avidity for human blood; but on account of its very local distribution it probably plays a very small part in the transmission of malaria in the Philippines, especially in the lowlands. It is said to be primarily a highland species, and if it should be found to be more prevalent in the mountain provinces it might prove to be of importance in the dissemination of malaria in those regions.

Anopheles sinensis, has a low, if not negative, susceptibility. It appears from the literature, as well as from our own observations, to be extremely localized in its geographical distribution in the Philippines; it is scarce, and is a relatively "wild" species. Therefore, while the few experiments made with it showed this species to have a relatively high avidity for human blood, it is probable that its part in the transmission of malaria in the Philippines is negligible.

Anopheles barbirostris stands the lowest in our experiments in its avidity for human blood, and it is a relatively "wild" species. It appears to have a wide but scattered distribution in the Philippines, and its susceptibility to infection with malarial parasites is rather feeble. On the whole, it is probable that this species plays a subordinate part in the spread of malaria in these Islands.

Anopheles rossii is one of the most domestic of the anophelines, with a relatively high avidity for human blood. It is very widely distributed, especially along the coast and lowlands, and is relatively prevalent. Its susceptibility to infection with the malarial parasite is rather low. It is possible that this species may play a certain rôle in the dissemination of malaria, especially along the extensive coasts of this Archipelago.

Anopheles febrifer is both a "wild" and also a domestic species in so far as shaded breeding places are afforded, with a relatively high avidity for human blood. It is by far the most susceptible among the 5 species investigated, and is probably the most susceptible species in the Philippines. If investigations, which are now being carried on by one of us (Barber),

prove it to be as widely distributed throughout the Archipelago as it is in Laguna Province, *Anopheles febrifer* is the most important mosquito concerned in the epidemiology of malaria in the Philippine Islands.

LITERATURE CITED IN THE TEXT

- ALCOCK, A. Synopsis of the anopheline mosquitoes of Africa and of the Oriental region. *Journ. London School Trop. Med.* (1913), 2, 153-166.
- ANNETT, H. E., DUTTON, J. E., and ELLIOTT, J. H. Report of the malaria expedition to Nigeria of the Liverpool School of Tropical Medicine and Medical Parasitology. Memoir 3 (1901). Published for the University Press of Liverpool by Williams and Norgate, 14 Henrietta St., Covent Garden, London; and 7 Broad St., Oxford.
- BANKS, C. S. A list of Philippine Culicidæ with descriptions of some new species. *Phil. Journ. Sci.* (1906), 1, 977-1005.
- IDEM. Experiments in malarial transmission by means of *Myzomyia ludlowii* Theob. *Ibid.*, Sec. B (1907), 2, 513-536.
- CHRISTOPHERS, S. R. Malaria in the Andamans. Scientific Memoirs by Officers of the Medical and Sanitary Departments of the Government of India. Office of the Superintendent of Government Printing, Calcutta, India (1912), n. s. No. 56.
- DARLING, S. T. Factors in the transmission and prevention of malaria in the Panama Canal Zone. *Ann. Trop. Med. & Parasit.* (1910), 4, 179-223.
- EYSELL, A. *Anopheles rossii*, ein gefährlicher Malaria-überträger. *Arch. f. Schiffs- u. Trop.-Hyg.* (1910), 14, 416-419.
- GILES, G. M. Notes on some collections of mosquitoes etc. received from the Philippine Islands and Angola. *Journ. Trop. Med.* (1904), 7, 365-369.
- JAMES, S. P. Malaria in India. Scientific Memoirs by Officers of the Medical and Sanitary Departments of the Government of India. Office of the Superintendent of Government Printing, Calcutta, India (1902) n. s. No. 2.
- JAMES, S. P., and STANTON, A. T. Revision of the names of Malayan Anophelines. *Trans. 2d Biennial Congress, Far Eastern Assoc. Trop. Med.*, Hongkong (1912), 313-317.
- KINGHORN, A., and YORKE, W. A further report on the transmission of human trypanosomes by *Glossina morsitans* Westw. *Ann. Trop. Med. & Parasit.* (1912), 6, 269-285.
- KNAB, F. The species of *Anopheles* that transmit human malaria. *Am. Journ. Trop. Dis. & Prevent. Med.* (1913), 1, 33-43.
- LUDLOW, C. S. The mosquitoes of the Philippine Islands. A thesis submitted to the faculty of graduate studies of the George Washington University in part satisfaction of the requirements for the degree of doctor of philosophy. Washington, D. C. (1908).
- LÜHE, M. Die in Blute schmarotzenden Protozoen und ihre nächsten Verwandten. Mense: Handbuch der Tropenkrankheiten (1906), 3, 254.
- SCHÜFFNER, W. Die Beziehungen der Malariaparasiten zu Mensch und Mücke an der Ostküste Sumatras. *Zeitschr. f. Hyg. u. Infektionskrankh.* (1902), 41, 89-122.

- STANTON, A. T. The anopheles mosquitoes of Malaya and their larvæ, with some notes on malaria-carrying species. *12th Annual Report Inst. Med. Research*, Kuala Lumpur, Federated Malay States (1912), 51-63.
- STEPHENS, J. W. W., and CHRISTOPHERS, S. R. The practical study of malaria and other blood parasites. 3d ed. (1906). Constable and Co. Ltd., 10 Orange St., Leicester Sq., London, W. C.
- STRONG, R. P. *Phil. Journ. Sci., Sec. B* (1910), 5, 344.
- THEOBALD, T. D. A monograph of the Culicidæ (1903), 3.
- THOMSON, D. The destruction of the crescents: conclusions regarding the prevention of malaria by the administration of quinine. *Ann. Trop. Med. & Parasit.* (1912), 6, 223-230.
- DE VOGEL, W. T. *Myzomyia rossii* as a malaria-carrier. *Phil. Journ. Sci., Sec. B* (1910), 5, 277-283.

NOTE.—Specimens of *Anopheles febrifer* were sent to Dr. C. S. Ludlow at the Army Medical Museum, Washington, D. C. Doctor Ludlow kindly examined the specimens and reported by letter dated December 1, 1914, that the species is *Myzomyia christophersi* Theobald and is the same mosquito as that which she has reported from the Philippines under the name of *M. funesta* Giles. (See Ludlow, Disease-bearing mosquitoes of North and Central America, the West Indies, and the Philippine Islands. Bull. No. 4. War Department. Office of the Surgeon General. November, 1913. p. 36.) As Doctor Ludlow states in this footnote, "What the proper name for this species is, seems a little clouded." *Myzomyia christophersi* (= *M. listoni*?) is a well known malaria carrier in the foothills of the Himalayas in India.

MALARIA IN THE PHILIPPINE GENERAL HOSPITAL, MANILA,
P. I., DURING THE FISCAL YEAR 1913

By DAVID G. WILLETS

(*From the Biological Laboratory, Bureau of Science, Manila, P. I.*)

INTRODUCTION

The object of this paper is to analyze the cases of malaria discharged from the Philippine General Hospital, during the fiscal year ending June 30, 1913. This analysis is based not on the results of a special study of malaria but on those of routine work. That this fact greatly affects the data submitted is apparent throughout the paper. I am responsible for the laboratory results adduced, while the credit and the responsibility for the clinical data rest with the clinicians.

FREQUENCY

A diagnosis of malaria was rendered in 348, or 5.17 per cent, of 6,732 cases discharged during the year; in 324, or 10.6 per cent, of 2,985 medical cases; in 15, or 2.09 per cent, of 717 obstetrical cases; and in 9, or 0.3 per cent, of 3,030 surgical cases. It follows that 93.1 per cent, 4.3 per cent, and 2.6 per cent of the 348 infections occurred in medical, obstetrical, and surgical cases, respectively.

According to the annual report of the Bureau of Health for the fiscal year 1913, a diagnosis of malaria was rendered in 6.1 per cent of the admissions to Baguio Hospital, Baguio, Benguet; in 1.5 per cent to Bilibid Prison Hospital, Manila; in 10.2 per cent to Butuan Hospital, Butuan, Agusan (Mindanao); and in 51.1 per cent to Iwahig Penal Colony Hospital, Palawan.

ORGANISM PRESENT

Of the 296 cases which were positive microscopically, 161, or 54.4 per cent, were infected with tertian; 150, or 50.6 per cent, with æstivo-autumnal; 3, or 1.0 per cent, with quartan; and 4, or 1.4 per cent, with unidentified parasites. Infection with both tertian and æstivo-autumnal organisms occurred in 22, or 7.4 per cent.

DISTRIBUTION OF CASES

A. Geographic distribution.—An analysis of the cases according to the apparent place of contraction of infection gave Manila 35.6 per cent, Mindoro 17.5 per cent, Tarlac Province 9.8 per cent, Laguna Province 9.5 per cent, and miscellaneous provinces 27.6 per cent. It is absolutely certain that the vast majority of the infections apparently contracted in Manila were in reality contracted elsewhere. As a matter of fact, while malaria is endemic in Manila it is not a common disease here. It is believed by some physicians that it is very rare indeed, because it is almost impossible to find an infection in an individual who has never been outside of the city limits. This same argument could, however, be applied to typhoid fever or any other disease which occurs here, as Manila occupies such a limited amount of territory that it would be rather difficult to find a child, to say nothing of an adult, who had not been recently beyond its borders into Rizal or Bulacan Province.

The Bureau of Health's report for 1913 for the entire Philippines, excepting Mindanao and Mindoro, gives a very different distribution of malaria in the Islands than is indicated in Table I. According to the clinical cause of death the distribution is, in part, as follows:

TABLE I.—*Distribution of malaria in the Philippine Islands.*

Province.	Percentage of deaths due to malaria clinically.	Province.	Percentage of deaths due to malaria clinically.
Cagayan	27.6	Laguna	17.8
Ambos Camarines	20.6	Tarlac	16.5
Batangas	18.6	Occidental Negros	16.3
Oriental Negros	18.4	Bohol	14.4
Leyte	18.0	Manila	0.8

Musgrave, Walker, and others¹ found malarial organisms in the blood of 34.06 per cent of 1,095 individuals in Mindoro, in February, 1912.

B. Race, sex, and age distribution.—The race, sex, and age distribution of the cases is given in Table II. Fifty per cent of 66 Japanese, 4.8 per cent of 5,166 Filipinos, 4.8 of 352 persons of miscellaneous race, and 4.2 per cent of 1,148 Americans were cases of malaria.

¹ *This Journal, Sec. B (1914), 9, 137.*

TABLE II.—Race, sex, and age distribution.

Race.	Num-ber.	Per-cent.	Sex.				Age.			
			Male.		Female. ^a		Adults.		Children.	
			Num-ber.	Per-cent.	Num-ber.	Per-cent.	Num-ber.	Per-cent.	Num-ber.	Per-cent.
Filipino	250	71.9	188	75.2	62	24.8	218	87.2	32	12.8
American	48	13.8	45	93.8	3	6.2	45	93.8	3	6.2
Japanese	33	9.5	33	100.0	---	---	33	100.0	---	---
Miscellaneous	17	4.8	17	100.0	---	---	16	94.1	1	5.9
Total	348	100.0	283	81.3	65	18.7	312	89.7	36	10.3

^a There are few foreign women in Manila.

LABORATORY EFFICIENCY

IN FINDING MALARIAL ORGANISMS IN CASES CLINICALLY POSITIVE

Seven of the 348 cases diagnosed were not examined in the laboratory. Of the remaining 341, 45 were negative and 296, or 85.1 per cent, were positive. In making the examinations, smears were made in the usual way and Wright's stain was used exclusively. The 45 negative cases have been analyzed as follows:

Two cases were positive in the laboratory when previously in the hospital. Each was given quinine after one negative examination and later was discharged recovered.

One was given quinine intravenously several hours before smears were taken. There was one laboratory examination; the patient was discharged recovered.

Twenty-one were given no quinine in the hospital excepting iron, quinine, and strychnine to 2 of them. Six gave a definite history of having taken quinine prior to admission. Most of the 21 gave a history of more or less typical malarial paroxysms. Some were doubtless convalescent when admitted. Fifteen were discharged recovered and 4 improved. One died of acute bacillary dysentery, chronic malarial splenitis being found at autopsy. One was a surgical case, which had rises of temperature after operation, and which was discharged later, the febrile attacks having subsided without the administration of quinine.

Ten, in addition to the 6 already mentioned, had been taking quinine before admission. Eight of these were given quinine in the hospital after one negative; 1 of these was given quinine in the hospital after two negative examinations. One was transferred to another institution (San Lazaro) after two neg-

ative examinations, no quinine having been given. Eight were discharged recovered, 1 improved.

Eleven other cases were given quinine in the hospital. The records do not give the quinine history of these cases. Six were negative microscopically once; 3, twice, 2, four times. Seven were discharged recovered; 1, improved; and 1, unimproved. Two died. Autopsy in one case disclosed chronic splenic hyperplasia of malarial origin, death being due to lobar pneumonia. Autopsy was not obtained in the other case.

From a consideration of the foregoing facts it appears that failure to find malarial organisms in the peripheral blood of these cases may have been due to several factors, namely:

1. Rendering a positive clinical diagnosis, upon scanty laboratory work. This is evidenced by the fact that 29 cases were examined once; 11, twice; 3, three times; and 2, four times. The practical question as to whether it is justifiable to delay treatment of suspected malarial cases until a positive laboratory diagnosis is made is here involved. In some cases it is justifiable and absolutely indicated, while it is quite contraindicated in others. The last word in an accurate diagnosis of malaria rests with the laboratory.
2. Absence of malarial organisms from the peripheral circulation. This may have been a factor in the seventeen or more cases which had been taking quinine prior to admission to the hospital and, also, in those cases which were apparently convalescent from slight attacks of malaria.
3. Errors in the laboratory.
4. Errors in the clinical diagnosis.

IN FINDING MALARIAL ORGANISMS IN CASES POSITIVE AT AUTOPSY

Dr. B. C. Crowell, pathologist of the Bureau of Science, found evidences of malarial infection in 19, or 5.6 per cent, of 338 autopsies performed upon individuals who died in the Philippine General Hospital during the year. Malaria was the immediate cause of death in 13, or 68.4 per cent, of the cases in which it was present and hence in 3.8 per cent of the total cases which came to autopsy. In 12 of the 13 cases the lesions were acute; in 1, chronic. The lesions were chronic in the 6 cases in which the immediate cause of death was not malaria, but bacillary dysentery in 1 case; nephritis in 1 case; bronchopneumonia in 1 case; lobar pneumonia in 2 cases; and peritonitis in 1 case.

The Bureau of Health report for 1913 gives 26,138, or 14.2 per cent, of 183,236 deaths in the Philippines, excepting Mindanao and Mindoro, due to malaria.

Of the 19 cases, clinical diagnosis was made of 73.7 per cent. The 5 cases which were not diagnosed clinically were as follows: (1) The patient arrived at the hospital in an unconscious condi-

tion and lived one hour after admission, (2) the patient was in the hospital twenty hours, (3) the patient had severe jaundice and was in the hospital three days, (4) the patient died of peritonitis, (5) the patient died of bacillary dysentery. In the first 3 cases acute, and in the last 2 cases chronic, lesions were found at autopsy.

Of the 19 cases, 15 were examined microscopically ante mortem. The cases not examined were 1 to 4, inclusive, enumerated above. Of the 15 cases examined, 13, or 86.7 per cent, were positive. Each of the 2 negative cases was examined once, and chronic lesions were found in each at autopsy. Bacillary dysentery was the cause of death in one, and lobar pneumonia in the other, case. Twelve, or 92.3 per cent, of the 13 positive cases were infected with æstivo-autumnal organisms and 1, or 7.7 per cent, was infected with tertian parasites.

MISCELLANEOUS LABORATORY FINDINGS

Of the 296 cases which were positive microscopically for malaria, 275 were medical, 13 obstetrical, and 8 surgical; 243 were admitted to the hospital primarily because of malaria, and 32 for miscellaneous reasons, the malaria infection being detected in the routine examinations. Among the 243 admitted because of malaria, conditions were present in 58 which obviously excluded them from consideration when endeavoring to establish the usual miscellaneous laboratory findings of malarial cases in the Philippines. The urinalysis, fæcal findings, hæmoglobin percentages, and leucocyte counts of the remaining 185 cases are given in Tables III to VI, inclusive.

TABLE III.—*Urinalysis.*^a

Examinations and findings.	Number.	Per cent.
Persons not examined.....	28	-----
Persons examined.....	157	-----
Persons negative.....	3	1.9
Persons with—		
Albumin.....	73	46.5
Albumin and casts.....	38	24.2
Albumin, casts, pus cells, and red cells.....	13	8.3
Albumin and pus cells.....	9	5.7
Albumin and red cells.....	8	5.1
Albumin, casts, and red cells.....	8	5.1
Albumin, casts, and pus cells.....	3	1.9
Albumin, pus cells, and red cells.....	2	1.3
Total.....	157	100.0

^a As a rule but one morning specimen of urine was examined. The heat and acetic acid test was used for albumin.

TABLE IV.—Fæcal findings.

Examinations and infections.	Number.	Per cent.
Persons not examined.....	32	
Persons examined.....	153	
Persons infected.....	133	86.9
Persons negative.....	20	13.1
Persons infected with—		
One species.....	37	24.2
Two species.....	54	35.3
Three species.....	35	22.8
Four species.....	7	4.6
Total.....	153	100.0
<i>Trichuris</i>	99	64.7
<i>Ascaris</i>	68	44.4
<i>Entamæba</i>	49	32.0
Hookworm.....	44	28.8
Monad.....	14	9.2
<i>Balantidium</i>	2	1.3
<i>Oxyuris</i>	1	0.7
<i>Strongyloides</i>	1	0.7
Total.....	278	181.8

The fæces, as a rule, were examined but once, and the specimens were obtained after the administration of magnesium sulphate. Four cover slip preparations were examined of each case. It appears from Table III that 133, or 86.9 per cent, were infected with one or more species of intestinal parasites and that there were 278 infections found in the 153 patients, or 181.8 infections per 100 persons.

TABLE V.—Hæmoglobin percentage.^a

Examinations and percentages.	Number.	Per cent.
Persons not examined.....	94	
Persons examined.....	91	
Persons with percentage of—		
25 to 50.....	10	11.0
55 to 75.....	24	26.4
80 to 95.....	57	62.6
Total.....	91	100.0

^a Estimated by Tallqvist's method.

TABLE VI.—Leucocyte counts.

Examinations and counts.	Number.	Per cent.
Persons not examined.....	54	-----
Persons examined.....	131	-----
Persons with counts, per c. mm., of—		
2,600 to 2,900.....	3	2.3
3,000 to 3,900.....	13	9.9
4,000 to 4,900.....	23	17.6
5,000 to 5,900.....	23	17.6
6,000 to 6,900.....	26	19.8
7,000 to 7,900.....	12	9.2
8,000 to 8,900.....	12	9.2
9,000 to 10,000.....	6	4.5
10,100 to 10,900.....	5	3.8
11,000 to 11,900.....	5	3.8
12,000 to 13,000.....	3	2.3
Total.....	131	100.0

The counts were made as soon as possible after admission. As a rule one count was made on each case, a Turck's counting chamber being used.

If from 6,000 to 10,000 leucocytes per cubic millimeter of blood are accepted as normal, the approximate average count would be about 8,000. In this series of cases the average count was about 6,420 which, although within normal limits, is so near the lower limit that it represents a leucopenia. Sixty-two, or 47.3 per cent, had a definite leucopenia; 56, or 42.7 per cent, a normal count; and 13, or 10.0 per cent, a leucocytosis. It will be recalled that cases with complications, which would obviously influence the leucocyte count, were excluded from this series and that the individuals in whom these infections occurred entered the hospital because of malaria. These results, therefore, apparently represent the leucocyte counts in malaria for this locality.

Thomson² found that the absolute count in malaria varies considerably. During sporulation, if it be slight (as occurs in latent or apparently cured cases), a leucocytosis is present, whereas, if it be marked (as exists during a definite paroxysm), there is almost invariably a leucopenia. Between paroxysms in cases of marked acute malaria the count increases up to or even beyond the normal count. These findings may explain some of the normal and abnormally high counts in the series of cases here reported. It would appear, however, that 52.7 is a rather

² *Ann. Trop. Med. & Parasit.* (1911-1912), 5, 83; *ibid.* (1912), 6, 215.

high percentage to be thus explained. Having noted the great frequency of intestinal parasitism and genito-urinary disorders in the Philippines, it was thought that perhaps a tabulation of the cases according to the fæcal and urinary findings might reveal the cause of many of the normal and the abnormally high counts. The results follow:

TABLE VII.—*Fæcal findings arranged according to the presence of a leucopenia, a normal count, or a leucocytosis.*

Examinations and findings.	Cases.	Leucopenia.		Normal count.		Leucocytosis.	
		Num-ber.	Per-cent.	Num-ber.	Per-cent.	Num-ber.	Per-cent.
Persons negative.....	13	7	53.8	5	38.5	1	7.7
Persons infected with—							
One species.....	30	15	50.0	12	40.0	3	10.0
Two species.....	41	16	39.0	22	53.6	3	7.3
Three species.....	29	14	48.3	11	37.9	4	13.8
Four species.....	4	2	50.0	2	50.0		
Total.....	117	54	46.1	52	44.5	11	9.4
<i>Ascaris</i>	56	27	48.2	24	42.9	5	8.9
<i>Trichuris</i>	76	32	42.1	38	46.1	9	11.9
Hookworm.....	35	15	42.9	16	45.7	4	11.4
<i>Entamæba</i>	36	18	50.0	16	44.4	2	5.6
Monad.....	8	3	37.5	4	50.0	1	12.5
<i>Balantidium</i>	2	2	100.0				
<i>Strongyloides</i>	1			1	100.0		
<i>Oxyuris</i>	1					1	
Total.....	215	97	44.9	96	44.4	22	10.2

TABLE VIII.—*Urinalyses arranged according to the presence of a leucopenia, a normal count, or a leucocytosis.*

Persons negative.....	1			1	100.0		
Persons with—							
Albumin.....	56	23	42.6	27	46.3	6	11.1
Albumin and red cells.....	7	4	57.1	3	42.9		
Albumin and pus cells.....	4	4	100.0				
Albumin, pus cells, and red cells.....	2	1	50.0	1	50.0		
Albumin and casts.....	29	14	48.3	12	41.4	3	10.3
Albumin, casts, and red cells.....	5	2	40.0	3	60.0		
Albumin, casts, and pus cells.....	3	2	66.7			1	33.3
Albumin, casts, pus cells, and red cells.....	11	7	63.6	4	36.4		
Total.....	118	57	48.3	51	43.2	10	8.5

A study of these tables will convince one that neither the fæcal nor the urinary findings alone nor the two combined are obviously responsible for causing the normal or the abnormally high counts. On the contrary, it would appear that each may have

contributed to the leucopenia. The fæcal findings among persons of foreign birth were excluded and those among Filipinos alone considered, but the general rules were not changed appreciably. It is not overlooked that the urinary findings were due doubtless to malaria itself in many of these cases.

The cause of many of the normal and the abnormally high counts in this series of cases is, therefore, considered to be undiscovered. Despite the unconvincing evidence presented in the tables, I am inclined to hold intestinal parasitism and genito-urinary disorders responsible for some of them.

SPLENIC INDEX

To determine the splenic index of malaria, the records of the first 1,000 cases for the year in which a complete physical examination had apparently been made were examined. In 799 of these cases the spleen was not enlarged; in 201, or 20.1 per cent, it was enlarged. Eight, or 1 per cent, of the cases with negative spleens were positive for malaria both clinically and microscopically. In these cases the spleen was tender in 1 case, not definitely mentioned in 3 cases, and not enlarged in 4 cases. Of the 201 enlarged spleens, 100, or 49.75 per cent, occurred in malarial, 67 in miscellaneous, and 34 in typhoid cases.

A number of the spleens were stated to be enlarged to percussion or palpable upon deep inspiration only. In order to arrive at a practical splenic index for malaria, it is deemed justifiable to exclude these cases. They were distributed as follows:

TABLE IX.—*Spleen enlarged to percussion or palpable on deep inspiration only.*

Cases.	Enlarged to percussion.	Palpable on deep inspiration.	Total.
Malarial.....	7	2	9
Miscellaneous.....	17	10	27
Typhoid.....	3	—	3
Total.....	27	12	39

Subtracting these cases from the original ones, there remain definitely enlarged spleens in malarial cases 91, or 56.1 per cent, in miscellaneous cases 40, in typhoid cases 31. If those in typhoid fever are excluded, the splenic index of malaria would be 69.5 per cent, or 91 in 131 cases.

An analysis of the 40 miscellaneous cases with definitely enlarged spleens is given in Table X. It indicates that the pres-

ence of malaria was not excluded satisfactorily from a number of them. Eighteen were examined once microscopically; 1, twice; and 21 not at all. Considering the foregoing data, it seems reasonable to believe that had sufficient effort been made some of these cases would have been positive. In other words, the splenic index of malaria, typhoid fever being excluded, would have been greater than 69.5 per cent in this series of cases.

TABLE IX.—*Forty miscellaneous cases with enlarged spleens.*

No.	Negative malaria examination.	Leucocyte count.	Diagnosis.
1	1	13,800	Tuberculosis, pulmonary.
2	1	5,600	Tuberculosis, pulmonary; pleuritis serofibrinous; helminthiasis.
3	1	12,000	Bronchitis, acute; amœbiasis; nephritis, acute; helminthiasis.
4	1	-----	Scabies; malaria; helminthiasis.
5	2	5,400	Malaria (?), amœbiasis, helminthiasis.
6	1	12,940	Cystitis, acute; prostatitis, acute; gonorrhœa, chronic; pyelonephritis(?).
7	1	5,000	Fever, dengue; nephritis(?); helminthiasis.
8	1	10,000	Fever, dengue; monadiasis.
9	1	8,200	Fever, dengue; helminthiasis.
10	1	5,000	Yaws, tertiary; amœbiasis; helminthiasis; wound, infected, tibia.
11	1	4,000	Fever, undetermined.
12	1	6,130	Do.
13	1	5,400	Helminthiasis; amœbiasis; blepharitis, acute; dermatitis, acute.
14	1	7,500	Rheumatism, acute.
15	1	10,000	Pneumonia, lobar; helminthiasis.
16	1	5,000	Malaria(?); helminthiasis.
17	1	7,320	Undetermined.
18	1	6,000	Fever, dengue.
19	1	4,400	Splenomegaly; wound, lacerated, perineum; wound, bilateral, cervix.
20	-----	6,000	Pleuritis, serofibrinous; helminthiasis; monadiasis; conjunctivitis.
21	-----	8,000	Splenomegaly at post mortem, etiology undetermined.
22	-----	5,400	Fever, undetermined; helminthiasis.
23	-----	5,000	Fever, dengue; helminthiasis.
24	-----	4,000	Fever, dengue; splenitis, acute.
25	-----	14,000	Yaws, tertiary; helminthiasis.
26	-----	16,000	Gastritis, acute.
27	-----	6,000	Pyelonephritis; monadiasis; helminthiasis.
28	-----	5,000	Nephritis, chronic.
29	-----	10,000	Ankylosis, monadiasis; helminthiasis.
30	-----	4,000	Fever, dengue; syphilis, tertiary; gonorrhœa, acute.
31	-----	6,000	Fever, undetermined.
32	-----	10,800	Ankylosis.
33	-----	9,035	Undetermined.
34	-----	12,700	Tuberculosis, pulmonary; nephritis, acute.
35	-----	4,400	Fever, dengue; helminthiasis.
36	-----	8,790	Nephritis, acute; amœbiasis; helminthiasis.
37	-----	7,000	Pneumonia, lobar; peritonitis, acute; nephritis, acute.
38	-----	5,800	Nephritis, acute; helminthiasis.
39	-----	8,000	Dysentery, bacillary; colitis, chronic; acne vulgaris.
40	-----	5,000	Pleuritis, acute; tuberculosis, pulmonary, incipient; helminthiasis.

Approaching the subject of splenic index from another point of view, one may consider what percentage of cases of clinical malaria with definitely enlarged spleens was positive microscopically. Two hundred sixty-six of the 348 cases diagnosed as malaria had enlarged spleens. Of the 266 cases, 2 were not examined in the laboratory. Of the remaining 264, 225, or 85.7 per cent, were positive and 39 negative microscopically.

Of the 39 cases which were microscopically negative, 14 were given no quinine in the hospital excepting that contained in iron, quinine, and strychnine to 2 of them. Six of these were examined once; 5, twice; and 3, three times. Sixteen cases had been taking quinine prior to the examination. Thirteen of these were examined once; 3, twice. One case had been positive in the laboratory during a previous admission. He was examined once microscopically. Five of the remaining 8 cases were examined once; 1, twice; and 2, four times. It thus appears that of the 39 cases under discussion 24 were examined once; 9, twice; 3, three times; and 2, four times.

The factors to be considered in interpreting these negative results are enumerated elsewhere in this report. A number of the cases came from districts known to be malarial, and positive laboratory findings would undoubtedly have been obtained had treatment been delayed; that is, more than 85.7 per cent of the cases with enlarged spleens and positive clinically for malaria would have been positive microscopically.

Musgrave, Walker, and others³ found malarial organisms in the blood of 105, or 41.01 per cent, of 256 individuals with enlarged spleens and enlarged spleens in 105, or 31.91 per cent, of 329 cases which were positive microscopically for malaria. In comparing their results with mine it is perhaps important to note that they were dealing chiefly with unselected persons whereas my cases were hospital patients.

SUMMARY

1. A diagnosis of malaria was rendered in 348, or 5.17 per cent, of 6,732 patients; in 10.6, 2.09, and 0.39 per cent of medical, obstetrical, and surgical cases, respectively.

2. Tertian, æstivo-autumnal, and quartan parasites were present.

3. Manila, Mindoro, and Tarlac and Laguna Provinces appeared to be the chief sources of infection. Many of the in-

³ *This Journal*, Sec. B (1914), 9, 137.

fections apparently contracted in Manila probably occurred elsewhere.

4. The majority of the infections occurred among adult male Filipinos.

5. Malarial organisms were found in 85.1 per cent of 341 cases examined microscopically. Failure to find them in a higher percentage was probably due to (a) rendering a positive clinical diagnosis upon scanty laboratory work; (b) absence of organisms from the peripheral circulation; (c) errors in the laboratory; and (d) errors in the clinical diagnosis.

6. Malarial lesions were found in 5.6 per cent of autopsies performed upon individuals who died at the Philippine General Hospital. A correct clinical diagnosis was rendered in 73.7 per cent of the cases. Organisms were found microscopically ante mortem in 13, or 86.7 per cent, of 15 cases examined. In the 2 cases which were negative, chronic lesions were present and death was not due to malaria.

7. In miscellaneous laboratory work upon 185 cases which were admitted to the hospital because of malaria, and which were positive both clinically and microscopically, special attention was given to the leucocyte counts. In 131 of the cases a leucopenia was present in 47.3 per cent; a normal count, in 42.7 per cent; and a leucocytosis, in 10.0 per cent. Some of the normal and abnormally high counts may be explained by the supposition that the blood was taken during sporulation in light or chronic cases and between paroxysms in heavy acute cases. It is believed, but not proved, that intestinal parasitism and disorders of the genito-urinary tract are responsible for some, at least, of the normal and abnormally high counts.

8. Typhoid fever being excluded, the malarial splenic index was 69.5 among the first 1,000 thoroughly examined medical cases admitted to the hospital during the year. Malaria was not satisfactorily excluded from a number of the cases with enlarged spleens. Typhoid fever likewise being excluded, malarial organisms were found in 85.7 per cent of 264 cases with enlarged spleens examined microscopically. Organisms could have been found in a number of the negative cases had treatment been delayed.

THE CHIEF INTESTINAL LESIONS ENCOUNTERED IN ONE THOUSAND CONSECUTIVE AUTOPSIES IN MANILA

By B. C. CROWELL

(From the Biological Laboratory, Bureau of Science, and the Department of Pathology, College of Medicine and Surgery, University of the Philippines)

One thousand consecutive autopsies, performed during the period of eighteen months from August, 1912, to February, 1914, have been reviewed to determine the incidence and character of the chief intestinal lesions. Especial attention has been given to the incidence of intestinal tuberculosis, typhoid fever, and amœbic and bacillary colitis.

The cases were derived from a large general hospital, a hospital for contagious diseases, and the medicolegal service of the city of Manila, so that all classes of cases were included. The overwhelming majority of the cases were Filipinos, although some other oriental races and some Caucasians were included. Two epidemic diseases, bubonic plague and Asiatic cholera, furnished 149 of the 1,000 cases, while many more were subjected to examination in order to prove or eliminate cholera. These latter cases furnished many examples of intestinal disorders, as the public-health authorities during the cholera epidemic naturally selected cases for autopsy diagnosis which gave a history either of sudden death or of diarrhœal disease.

The incidence of parasitic metazoa has not been especially investigated in this series; their incidence in 500 autopsies already has been reported.¹ Other than numerically the cholera cases will not be referred to in this report, as they furnish the subject of another paper.²

TABLE I.—Incidence of intestinal diseases in 1,000 consecutive autopsies in Manila.

Asiatic cholera	92
Intestinal tuberculosis	56
Typhoid fever	39
Entamœbic colitis	31
Bacillary colitis	25
Duodenal ulcer	9
Noninfectious or unclassified inflammatory lesions of intestines	57

In 17 cases two or more of the above lesions were coexistent in the same case. For example, 7 of the cases of tuberculosis

¹ Crowell and Hammack, *This Journal*, Sec. B (1913), 8, 157.

² Crowell, B. C., *ibid.* (1914), 9, 361.

died of cholera; bacillary colitis had supervened upon an old case of entamœbic colitis. The anatomical lesions associated with these intestinal diseases have been so characteristic of the diseases in which they occurred that their simple notation almost suffices to explain their importance.

INTESTINAL TUBERCULOSIS

In view of the well-known prevalence of tuberculosis in the Philippine Islands, it was to be expected that tuberculous intestinal lesions would stand first numerically. The latest report of the Director of Health shows that during the fiscal year 1913 tuberculosis was responsible for 17.9 per cent of the deaths of the residents in the city of Manila. Our work shows that 5.6 per cent (56 cases in all) of all cases coming to autopsy had intestinal tuberculosis.

TABLE II.—*Causes of death in 56 cases of intestinal tuberculosis.*

Generalized tuberculosis	35
Perforation of tuberculous ulcer	3
Intercurrent diseases:	
Asiatic cholera	7
Bacillary dysentery	1
Typhoid	1
Malaria	1
Leprosy	1
Gastric cancer	1
Fatty heart	1
Pregnancy	1
Postpartum sepsis	1
Postoperative peritonitis	1
Cholangitis	1
Chronic nephritis	1

In a majority of these cases tuberculosis was widespread throughout the body, and 35 patients died of generalized tuberculosis. Three cases of perforation of tuberculous ulcers occurred, 1 at a point 30 centimeters above the ileocæcal valve, 1 in the cæcum, and 1 in the rectum. The other cases died of intercurrent diseases. From the standpoint of clinical diagnosis, it would seem important to remember that an extensive tuberculous colitis may closely simulate an entamœbic colitis, and several such cases have been encountered.

The cases dying of intercurrent diseases require no comment. In general, it may be said that tuberculosis as it attacks Filipinos is very frequently extremely widespread throughout the system and in the intestine the lesions extend throughout a large part of its length.

TYPHOID FEVER

The frequency of entamœbic and bacillary colitis in Manila is often referred to, while but little emphasis has been placed on the prevalence of typhoid fever. In our autopsy experience, it is found more frequently than either entamœbic or bacillary dysentery. It will never be known whether this increased statistical frequency of typhoid fever is actual or is due to improved methods of diagnosis and closer investigation. Thirty-seven of the 39 cases occurred in Filipinos, 1 in a Chinese, and 1 in a Japanese. No typhoid in Caucasians was encountered in this series.

The following table excellently exemplifies the usual causes of death in typhoid fever cases and their relative frequency. In 22 of 39 cases (56.4 per cent) typhoid lesions were present in the colon as well as in the ileum.

TABLE III.—*Causes of death in 39 cases of typhoid fever.*

Intestinal perforation	12
Intestinal hæmorrhage	5
Suppurative nephritis (pyæmic)	2
Lobar pneumonia	2
Perforation of gall bladder	1
Toxæmia	17

Those cases tabulated as dying of toxæmia include those cases in which there were no severe gross anatomical lesions explanatory of death other than the intestinal lesions, bronchopneumonia, degeneration of the heart muscle, or other evidences of severe toxæmia. Thirty per cent died of intestinal perforation and 12 per cent died of hæmorrhage.

ENTAMŒBIC COLITIS

TABLE IV.—*Causes of death in 31 cases of entamœbic colitis.*

Liver abscess	9
Acute peritonitis:	
Perforation ^a	2
No perforation	3
Toxæmia	3
Intercurrent diseases:	
Lobar pneumonia	2
Tuberculosis	5
Perforation of duodenal ulcer	1
Accident	1
Sarcoma	1
Cirrhosis of liver	1
Pulmonary abscess	1
Arteriosclerosis	1
Beriberi	1
Postpartum sepsis	1

^a One of these had also a liver abscess.

The causes of death in entamœbic dysentery cases are summed up by Strong³ as follows:

Death may occur in amœbic dysentery from the gravity of the intestinal lesions; from exhaustion in protracted cases; from severe complications, particularly such as peritonitis due to the perforation of an ulcer in the large intestine or appendix or an abscess of the liver or lung; from a terminal infection sometimes entering through the ulcerations in the large bowel; from intercurrent disease, and from severe intestinal hemorrhage.

All of these conditions, except the hæmorrhage, have been encountered in our series.

The liver abscesses here referred to are entamœbic abscesses secondary to entamœbic colitis, and do not include ordinary pyæmic abscesses or those secondary to suppurative cholangitis; a number of these cases have been encountered in the present series of 1,000 autopsies.

Liver abscesses occurred in 9 (29 per cent) of our cases of entamœbic colitis. This represents, it must be remembered, the incidence in fatal cases of entamœbic colitis, and is no indication of its frequency clinically. Three of these cases were in Americans and 6 in Filipinos, all being males. Five of the cases of liver abscess had operative drainage of the abscesses. In all of the cases of liver abscess entamœbic colitis was present, but there has been established no relation between the severity of the intestinal lesions and the occurrence of the liver abscesses. It is noteworthy that in several cases of liver abscess with extensive ulcerative colitis the patients denied any history of dysenteric symptoms. In 4 of the cases there was a single abscess, while in the other 5 cases there were multiple abscesses. The right lobe was the most frequent site of the abscess, but in some cases the left lobe also was involved and in 1 case the Spigelian lobe was entirely destroyed. In two cases the abscess had perforated the diaphragm, but in both the destructive process was confined to the diaphragmatic surface of the lung by the presence of fibrinous adhesions. Four other cases presented a right-sided fibrinous pleurisy over the diaphragmatic surface and in some cases fibrous adhesions were also present. One of the cases with liver abscess died as the result of an acute peritonitis from an entamœbic ulcer of the vermiform appendix, and in 1 case the gall bladder was filled with pus similar to that found in the liver abscess.

The 5 cases referred to in the table as having acute peritonitis do not include the cases of liver abscess. In 2 of the cases there was actual perforation of the intestine at the site of ulceration,

³ *Pub. P. I. Bur. Gov. Labs.* (1905), 5, No. 32, 5.

while in the other 3 cases the infection of the peritoneum is supposed to have entered through the thinned wall of the intestine at the site of ulceration. Of the 2 perforations, 1 occurred in the descending colon near the sigmoid flexure and 1 in the vermiform appendix. The latter case also had liver abscesses.

The 3 cases referred to in the table as dying of toxæmia apparently died as the result of the severity of the intestinal lesions.

BACILLARY COLITIS

TABLE V.—*Causes of death in 25 cases of bacillary colitis.*

Toxæmia	13
Complications:	
Acute peritonitis	3
Abortion	2
Postpartum sepsis	1
Intercurrent diseases:	
Tuberculosis	2
Malaria	2
Noma	1
Leprosy	1

Fourteen of these cases occurred in children under 7 years of age. In 12 of the cases there was involvement of the lower portion of the ileum, this involvement varying from a hyperæmia to marked diphtheritic inflammation.

The cases referred to as dying of toxæmia are those in which no essential lesions were found outside of the intestine, save degenerative lesions, and 6 of those cases had a bronchopneumonia. Stated roughly it may be said that bronchopneumonia is present in from one-third to one-half of the cases of bacillary colitis in this series, dying as the result of the severity of the intestinal lesions. In none of the cases presenting an acute peritonitis was this lesion an extensive one, and it apparently represented only a terminal infection which had passed through the diseased colon.

The occurrence of 3 cases associated with pregnancy indicates the danger of bacillary colitis occurring during pregnancy and that the two conditions may influence each other unfavorably.

In 1 case intestinal tuberculosis coexisted with the bacillary colitis, and in 1 case entamœbic and bacillary colitis were both present. It is possible that more careful investigation would enable one to recognize a superadded bacillary infection in a greater number of the cases of entamœbic colitis, whereas it is rather difficult of detection in routine examinations of a large number of bodies, on account of both the anatomical and bacteriological difficulties in diagnosis.

It may be stated here that the etiologic agent was not isolated in all of the cases of either entamœbic or bacillary colitis here recorded. In the majority of the cases either the entamœba or the dysentery bacillus was isolated, but in the remainder the diagnosis has been based on the gross and microscopic examinations.

No serious attempt has been made here to differentiate the cases of bacillary colitis into types corresponding to types of bacteria, the bacteriological diagnosis, when made, having been based chiefly on agglutination with a polyvalent antidysenteric serum.

DUODENAL ULCERS

A review of the intestinal lesions encountered would not be complete without reference to the duodenal ulcers.

Nine cases of duodenal ulcer have been encountered in the series, 6 of which had perforated. In no case had the clinical diagnosis of duodenal ulcer been made. In 2 cases a diagnosis of cholecystitis was made, and in 1 cholecystectomy was performed. Severe anæmia was apparently prominent in 2 cases, for in 1 case the diagnosis of pernicious anæmia and in another that of secondary anæmia had been made.

Eight of the ulcers were in the first part of the duodenum, while one involved the orifice of the common bile duct, so that the bile duct emptied into the base of the ulcer. Contrary to rule, 7 of them occurred on the posterior wall, while 1 was on the anterior wall, and the position of the other was not recorded. Three occurred in the third decade of life, 3 in the fourth, 2 in the fifth, and 1 in the sixth. There are in the department the records and specimens of 2 cases, not included in this series, of duodenal ulcers in infants, 1 aged 6 months and 1 aged 7 months.

In the same series, 15 peptic ulcers of the stomach have occurred.

NONSPECIFIC OR UNCLASSIFIED INFLAMMATORY LESIONS OF THE INTESTINE

This very important group includes 57 cases, 35 of which occurred in infants and 22 in adults.

Reference to Table VI will show that there was sufficient explanation for the intestinal lesions in all but 5 cases in adults. These 5 cases were examined for cholera vibrios unsuccessfully, and their etiology has not been explained. The majority of the cases in infants were also found negative bacteriologically for cholera, and none of those included in this table presented the characteristic anatomical lesions of cholera. Nor were any of these cases in infants of the type of a bacillary

colitis, those cases being included in the previous table. The majority of the infants were extremely emaciated, and many presented a bronchopneumonia; diseases of the skin were frequent among them. For the most part, they come under the head of those cases which in the hospital wards for children are usually styled "feeding cases." These, however, do not include all the cases. It is an open question whether these cases are accounted for simply by poor or injudicious feeding, by actual, exogenous infection, or by the action of the normal flora of the intestine under unfavorable conditions. Careful bacteriological examination of the fæces before or after death in a series of these cases might produce data of academic or scientific value, but the practical fact remains that careful nursing under hygienic conditions is the remedy.

TABLE VI.—*Associated conditions in nonspecific or unclassified inflammatory lesions of the intestine.*

Enteritis.		Colitis.		Enterocolitis.	
Adults, 15.	Infants, 11.	Adults, 4.	Infants, 11.	Adults, 3.	Infants, 13.
1. Opiu m poison- ing.		1. Genitouri- nary in- fection.		1. Uræmia.	
2. Cholan- giti s etc.		2. Genitouri- nary in- fection.		2. Perforation of gall bladder into duo- denum.	
3. Lobar pneumo- nia.		3. Uræmia.		3. (?)	
4. Lobar pneumo- nia.		4. Extensive burns.			
5. Chronic nephri- tis.					
6. Chronic nephri- tis.					
7. Chronic nephri- tis.					
8. Chronic nephri- tis.					
9. Sepsis.					
10. Malaria.					
11. Trauma.					
12. (?)					
13. (?)					
14. (?)					
15. (?)					

SUMMARY AND CONCLUSIONS

In a series of 1,000 consecutive autopsies in Manila, performed during eighteen months, aside from the incidence of intestinal parasites and tumors and the lesions in bubonic plague, intestinal lesions have been encountered in 292 cases. In this series Asiatic cholera (on account of an epidemic occurring during this period) stood first numerically. Second in importance was intestinal tuberculosis, and attention has been drawn to the possibility of the occurrence of dysenteric symptoms in this condition and to the perforation of intestinal ulcers in three cases. Typhoid fever was present more frequently than either entamœbic or bacillary colitis, and these typhoid cases showed a high percentage of perforations (30 per cent) and hæmorrhages (12 per cent), all of the cases being among Orientals. Entamœbic and bacillary colitis have been encountered with less frequency than the preceding diseases, and have presented many of the possible complications and sequelæ. Liver abscesses occurred in 29 per cent of the entamœbic cases, and in 2 cases the intestines had perforated. Bacillary colitis was present more frequently in children than in adults. Nine cases of duodenal ulcers were encountered, 6 of which had perforated, and 15 cases of peptic ulcer of the stomach occurred in the same series. Severe anæmia and symptoms referable to the gall bladder were prominent in some of the cases of duodenal ulcer. Unclassified, probably nonspecific inflammatory lesions of the intestines, especially in infants, occupy an important place, and offer a promising field for further etiological study.

REVIEWS

A Text-book | of | Physiology | for | Medical Students and Physicians | by | William H. Howell, Ph. D., M. D., Sc. D., Ll. D. | professor of physiology in the Johns Hopkins University, Baltimore | fifth edition, thoroughly revised | Philadelphia and London | W. B. Saunders Company | 1913. Cloth, pp. 1020, 306 figures, \$4 net.

Professor Howell's textbook, since its first appearance, has been the best presentation of this subject for the use of medical students. It is particularly fortunate that the demand for the book has been so great that frequent revisions are possible. The physician or student will find in the text the more significant advances in this science almost to date.

R. B. GIBSON.

A Text-book of | General | Bacteriology | by | Edwin O. Jordan, Ph. D. | professor of bacteriology in the University of Chicago | and in Rush Medical College | [dash] | fully illustrated | [dash] | third edition, thoroughly revised | Philadelphia and London | W. B. Saunders Company | 1913 | Cloth, pp. 1-623.

The third edition of this already well-known and justly popular book deserves praise. The author has covered the ground thoroughly, and the important material added to the chapters on cholera, typhoid fever, and leprosy brings this edition well up-to-date.

J. A. JOHNSTON.

The | Microtometist's Vade-mecum | a handbook of the methods of | microscopic | anatomy | by | Arthur Bolles Lee | seventh edition | Philadelphia | P. Blakiston's Son & Co. | 1012 Walnut Street | 1913 | Cloth, pp. i-x +1-526. Price, \$4 net.

Lee's Microtometist's Vade-mecum probably needs an introduction to but few laboratory workers in English-speaking countries. The first edition appeared in 1885 and has been kept up to date by frequently revised editions. The seventh edition probably includes more accurate information on histological technique than any other book in English, giving laboratory methods in detail, and making them readily available by a comprehensive index. The references to original articles is not one of the least valuable parts of the book.

B. C. C.

Disease | and Its Causes | by | W. T. Councilman, A. M., M. D., LL. D. | professor of pathology, Harvard University | [seal] | New York | Henry Holt and Company | London | Williams and Norgate | Cloth, pp. i-viii+1-254. 22 text figures. Price, \$0.50 net.

Disease and Its Causes is an example of the exposition of a subject for the laity by one of the foremost authorities on that subject. In this little volume, No. 68 of the Home University Library series, Doctor Councilman has very clearly and very attractively portrayed disease as "life under conditions which differ from the usual." The development of the science of medicine has been forcefully presented, and the causes of disease have been classified and displayed as factors producing reactions on the part of the body which constitute the symptoms of disease. The laws of nature as exemplified in inheritance and the normal growth of the body are presented, and their influence is shown to be paramount. Every part of the book contains something of value, and the book as a whole is one which the laity can read profitably without being under the necessity of mastering many technical details to understand disease and its causes. As an author is mirrored in his writings, this book also furnishes the medical reader with a great authority's conception of the subject, which might not be gained by a perusal of some of his more strictly technical monographs.

B. C. C.

A | Text-book | of | Histology | arranged upon an embryological basis | by | Dr. Frederic T. Lewis | assistant professor of embryology at the Harvard Medical School | and | Dr. Philipp Stöhr | formerly professor of anatomy at the University of Würzburg | second edition, with 495 illustrations | being the seventh American edition of Stöhr's histology | from the fifteenth German edition, edited by Dr. O. Schultze | Philadelphia | P. Blakiston's Son & Co. | 1012 Walnut Street | 1913 | Cloth, pp. i-ix+1-539. Price, \$3 net.

The seventh American edition of Stöhr's classical *Lehrbuch der Histologie und der mikroskopischen Anatomie des Menschen* has been prepared by Lewis and is published as of joint authorship. The previous editions of this work have been recognized as forming a standard in histology. This edition presents certain modifications in the method of presentation of the subject matter, and still retains much of the original text and the majority of its figures. This edition is even an improvement on its predecessors.

B. C. C.

Malaria | etiology, pathology, diagnosis, | prophylaxis, and treatment | by | Graham E. Henson, M. D. | member American Medical Association, Florida Medical Association, Southern | Medical Association, American Society of Tropical Medicine, Medical | Reserve Corps, United States Army (non-active list) | with an introduction by | Charles C. Bass, M. D. | professor of experimental medicine, medical department | Tulane University, New Orleans | twenty-seven illustrations | St. Louis | C. V. Mosby Company | 1913 | Cloth, pp. 1-190. Price, \$2.50.

As the author states in his preface, one of the chief aims of the book is to make a presentation of the subject especially useful to the general practitioner in malarious regions. In this he has succeeded. A large proportion of the work is given to the subjects of the pathology, diagnosis, prophylaxis, and treatment of the disease. The illustrations are reproduced from photographs, microphotographs, and drawings.

M. A. B.

Tropical Diseases | a manual of the diseases | of warm climates | by | Sir Patrick Manson | G. C. M. G., M. D., LL. D. (Aberd.) | fellow of the Royal College of Physicians, London; [etc., 7 lines] | with 12 colour and 4 black-and-white plates | and 239 figures in the text | fifth edition, revised throughout and | enlarged | New York | William Wood and Company | MDCCCXIV | Cloth, i-xxiv+1-937. Price, \$5.

In this edition of *Tropical Diseases* much new material is added to an already excellent book. The relatively small size of the volume, 12 by 18.5 centimeters, makes it convenient for one who is unable to carry larger reference books with him.

M. A. B.

Marriage and | Genetics | laws of human breeding | and | applied eugenics | by | Charles A. L. Reed, M. D.; F. C. S. | fellow of the College of Surgeons of America; | member [etc., 3 lines] | The Galton Press, Publishers | Cincinnati, Ohio, U. S. A. | Rubber-stamped, Date of issue Sep. 10, 1913. Cloth, pp. 1-183. Price, \$1.

The book springs from a desire in some measure to overcome the ignorance which, in too many instances, keeps innocent victims from protecting themselves and their offspring from disease and degeneracy. The problem is vital. It is first an individual, then a race problem. The question, "what of me and my family," must be asked before that of "what of my neighbors and their families." Both must be asked, but this is the necessary order.

The problem deals with the deepest human sentiment and the profoundest welfare of society now as well as in the future. The book attempts to present as simply as possible the fundamental laws of race perpetuation, considering causes and effects

in relation thereto and indicating some of the measures available to society to repress or to eliminate practices and hereditary strains that tend to degeneracy, and to foster as far as possible those that tend to human betterment. The Introduction, and the two divisions entitled *The Race Poisons*, and *Applied Eugenics*, may be easily and profitably read by any intelligent person, and most persons can follow the other division called *General Laws of Genetics* even though they are not already familiar with the laws of Weismann, Haeckel, Galton, or Mendel. In fact, a careful study of Reed's presentation of these laws will make a good introduction to them and well repay the reader for his effort.

The message of the book is especially addressed to every prospective husband and wife. Knowledge is the best preventive of disaster. The book should have extensive and thoughtful reading.

C. E. Cox.

Further Researches | into | induced Cell-reproduction | and Cancer | consisting of papers by | H. C. Ross, M. R. C. S. England, L. R. C. P. London | J. W. Cropper, M. B., M. Sc. Liverpool, and | E. H. Ross, M. R. C. S. England, L. R. C. P. London | with illustrations | the McFadden | researches | [Rubber-stamped: P. Blakiston's Son & Co., Publishers, | 1012 Walnut St., Philadelphia] | London | John Murray, Albemarle Street, W. | September 1911 | Cloth, pp. 1-63. Price, \$1 net.

Muscle Spasm and Degeneration | in intrathoracic inflammations | their importance as diagnostic aids and their influence in producing and altering | the well established physical signs, also a consideration of their | part in the causation of changes in the bony thorax | and | light touch palpation | the possibility and practicability of delimiting normal organs and | diagnosing diseased conditions within the chest and | abdomen by very light touch | by | Francis Marion Pottenger, A. M., M. D., LL. D. | medical director of the Pottenger Sanatorium for Diseases of the Lungs and Throat, | Monrovia, California | sixteen illustrations | St. Louis | C. V. Mosby Company | 1912 | Cloth, pp. 1-105.

**PUBLICATIONS FOR SALE BY THE BUREAU OF SCIENCE,
MANILA, PHILIPPINE ISLANDS—Continued**

BOTANY

A FLORA OF MANILA

By **ELMER D. MERRILL**

Order No. 419. Paper, 490 pages, \$2.50, postpaid.

Practically a complete flora of the cultivated areas in the Philippines. Descriptions, with keys, of over 1,000 species, 590 genera, and 136 families, with native names, glossary of technical terms, etc.

THE COCONUT PALM IN THE PHILIPPINE ISLANDS

Order No. 37. Paper, 149 pages, 30 plates, \$1, postpaid.

The reprint contains the following articles: On the Water Relations of the Coconut Palm (*Cocos nucifera*), The Coconut and its Relation to Coconut Oil, The Keeping Qualities of Coconut Oil and the Causes of its Rancidity, and The Principal Insects Attacking the Coconut Palm.

INDO-MALAYAN WOODS

By **FRED W. FOXWORTHY**

Order No. 411. Paper, 182 pages, 9 plates, \$0.50, postpaid.

In Indo-Malayan Woods, Doctor Foxworthy has brought together a large amount of accurate information concerning trees yielding woods of economic value.

ZOOLOGY

A LIST OF THE MAMMALS OF THE PHILIPPINE ISLANDS, EXCLUSIVE OF THE CETACEA

By **NED HOLLISTER**

Order No. 418. Paper, 64 pages, \$0.50, postpaid.

This is the only recent attempt to enumerate the mammals of the Philippine Islands. The distribution of each species is given, and the original descriptions are cited.

ZOOLOGY—Continued

A MANUAL OF PHILIPPINE BIRDS

By **RICHARD C. MCGREGOR**

Order No. 103. Paper, 2 parts, 769 pages, \$4, postpaid.

A Manual of Philippine Birds contains in compact form descriptions of all the known species of Philippine birds. The usual keys and diagnoses of orders, families, and genera help the novice in identification.

A CHECK-LIST OF PHILIPPINE FISHES

By **DAVID STARR JORDAN** and **ROBERT EARL RICHARDSON**

Order No. 102. Paper, 78 pages, \$0.75, postpaid.

This list will be found a convenient guide to the synonymy of Philippine ichthyology. The nomenclature is thoroughly revised, and the distribution of each species within the Philippine Islands is given.

MEDICINE

REPORT OF THE INTERNATIONAL PLAGUE CONFERENCE

Held at Mukden, April, 1911, under the auspices of the Chinese Government.

Edited by **ERICH MARTINI**, **G. F. PETRIS**, **ARTHUR STANLEY**, and **RICHARD P. STRONG**

483 pages, 18 plates (2 colored, 4 halftones, 12 charts and maps)

Order No. 416. Paper, \$2.50; cloth, \$3.50; postpaid.

The proceedings of this International Conference and information gained therefrom, together with the results of certain bacteriological investigations, constitute the present report.

The Bureau of Science of the Government of the Philippine Islands has been appointed sole agent for the distribution of the printed proceedings of the International Plague Conference.

PRICES ARE IN UNITED STATES CURRENCY

Orders for these publications may be sent to the **BUSINESS MANAGER, PHILIPPINE JOURNAL OF SCIENCE, BUREAU OF SCIENCE, MANILA, P. I.**, or to any of the agents listed below. Please give order number.

The Macmillan Company, 64-66 Fifth Avenue, New York, U. S. A.
Wm. Wesley & Son, 28 Essex Street, Strand, London, W. C., England.
Martinus Nijhoff, Lange Voorhout 9, The Hague, Holland.
Mayer & Müller, Prinz Louis Ferdinandstrasse 2, Berlin, N. W., Germany.
Kelly & Walsh, Ltd., 32 Raffles Place, Singapore, Straits Settlements.
A. M. & J. Ferguson, 19 Baillie Street, Colombo, Ceylon.
Thacker, Spink & Co., P. O. Box 54, Calcutta, India.

CONTENTS

	Page
WALKER, ERNEST LINWOOD and BARBER, MARSHALL A. Malaria in the Philippine Islands. I. Experiments on the Transmission of Malaria with <i>Anopheles (Myzomyia) febrifer</i> sp. nov., <i>Anopheles (Pseudomyzomyia) rossii</i> , <i>Anopheles</i> (<i>Myzorhynchus</i>) <i>barbirostris</i> , <i>Anopheles (Myzorhynchus)</i> <i>sinensis</i> , and <i>Anopheles (Nyssorhynchus) maculatus</i>	381
WILLETS, DAVID G. Malaria in the Philippine General Hos- pital, Manila, P. I., during the Fiscal Year 1913	441
CROWELL, B. C. The Chief Intestinal Lesions Encountered in One Thousand Consecutive Autopsies in Manila.....	453
REVIEWS	461

	U. S. currency
The "Philippine Journal of Science" is issued as follows:	
Section A. Chemical and Geological Sciences and the Industries..	\$2.00
Section B. Tropical Medicine	3.00
Section C. Botany	2.00
Section D. General Biology, Ethnology, and Anthropology (Sec- tion D began with Volume V)	2.00
Entire Journal, Volume II, III, IV, or V	5.00
Entire Journal, beginning with Volume VI	7.00
Single numbers of Volume I75
Single numbers (except of Volume I)50
Volume I, 1906 (not divided into sections) and supplement, sold only with a complete file of section A, B, or C.....	10.00
Supplement to Volume I (Botany)	3.50
Volume I (without supplement), sold only with a complete file of section A, B, or C.....	6.50
<i>Each section is separately paged and indexed.</i>	

Publications sent in exchange for the Philippine Journal of Science should be addressed: Library, Bureau of Science, Manila, P. I.

Subscriptions may be sent to the BUSINESS MANAGER, Philippine Journal of Science, Bureau of Science, Manila, P. I., or to any of the agents listed below:

AGENTS

The Macmillan Company, 64-66 Fifth Avenue, New York City, U. S. A.
Wm. Wesley & Son, 23 Essex Street, Strand, London, W. C., England.
Martinus Nijhoff, Lange Voorhout 9, The Hague, Holland.
Mayer & Müller, Prinz Louis Ferdinandstrasse 2, Berlin, N. W., Ger-
many.
Kelly & Walsh, Limited, 32 Raffles Place, Singapore, Straits Settlements.
A. M. & J. Ferguson, 19 Baillie Street, Colombo, Ceylon.
Thacker, Spink & Co., P. O. Box 54, Calcutta, India.

VOL. IX, SEC. B, No. 6

NOVEMBER, 1914

THE PHILIPPINE JOURNAL OF SCIENCE

ALVIN J. COX, M. A., PH. D.
GENERAL EDITOR

SECTION B TROPICAL MEDICINE

EDITED WITH THE COÖPERATION OF
E. L. WALKER, S. D.; M. A. BARBER, PH. D.; A. R. WARD, D. V. M.
Committee on Experimental Medicine
V. G. HEISER, M. D.; W. E. MUSGRAVE, M. D.; B. C. CROWELL, M. D.
Committee on Clinical Medicine
R. C. MCGREGOR, A. B.



MANILA
BUREAU OF PRINTING
1914

PUBLICATIONS FOR SALE BY THE BUREAU OF SCIENCE,
MANILA, PHILIPPINE ISLANDS

ETHNOLOGY

A VOCABULARY OF THE IGOROT LANGUAGE AS SPOKEN BY THE BONTOC IGOROTS

By WALTER CLAYTON CLAPP

Order No. 403. Paper, 89 pages, \$0.75, postpaid.

The vocabulary is given in Igorot-English and English-Igorot.

THE NABALOI DIALECT

By OTTO SCHEERER

and

THE BATAKS OF PALAWAN

By EDWARD Y. MILLER

Order No. 403. Paper, \$0.25; half morocco, \$0.75; postpaid.

The Nabaloi Dialect (65 pages, 29 plates) and the Bataks of Palawan (7 pages, 6 plates) are bound under one cover.

THE BATAN DIALECT AS A MEMBER OF THE PHILIPPINE GROUP OF LANGUAGES

By OTTO SCHEERER

and

"F" AND "V" IN PHILIPPINE LANGUAGES

By CARLOS EVERETT CONANT

Order No. 407.

These two papers are issued under one cover, 141 pages, paper, \$0.80, postpaid.

THE SUBANUNS OF SINDANGAN BAY

By EMERSON B. CHRISTIE

Order No. 410. Paper, 121 pages, 1 map, 29 plates, \$1.25, postpaid.

Sindangan Bay is situated on the northern coast of Zamboanga Peninsula. The Subanuns of this region were studied by Mr. Christie during two periods of five and six weeks, respectively.

The 29 plates illustrate the Subanuns at work and at play; their industries, houses, altars, and implements; and the people themselves.

THE HISTORY OF SULU

By NAJEEB M. SALEEBY

Order No. 406. Paper, 275 pages, 4 maps, 2 diagrams, \$0.75, postpaid.

In the preparation of his manuscript for The History of Sulu, Doctor Saleeby spent much time and effort in gaining access to documents in the possession of the Sultan of Sulu. This book is a history of the Moros in the Philippines from the earliest times to the American occupation.

ETHNOLOGY—Continued

STUDIES IN MORO HISTORY, LAW, AND RELIGION

By NAJEEB M. SALEEBY

Order No. 405. Paper, 107 pages, 16 plates, 5 diagrams, \$0.25; half morocco, \$0.75; postpaid.

This volume deals with the earliest written records of the Moros in Mindanao. The names of the rulers of Magindanao are recorded in five folding diagrams.

NEGRITOS OF ZAMBALES

By WILLIAM ALLAN REED

Order No. 402. Paper, 83 pages, 62 plates, \$0.25; half morocco, \$0.75; postpaid.

Plates from photographs, many of which were taken for this publication, show ornaments, houses, men making fire with bamboo, bows and arrows, dances, and various types of the people themselves.

INDUSTRIES

PHILIPPINE HATS

By C. B. ROBINSON

Order No. 415. Paper, 66 pages, 8 plates, \$0.50 postpaid.

This paper is a concise record of the history and present condition of hat making in the Philippine Islands.

THE SUGAR INDUSTRY IN THE ISLAND OF NEGROS

By HERBERT S. WALKER

Order No. 412. Paper, 145 pages, 10 plates, 1 map, \$1.25, postpaid.

Considered from the viewpoint of practical utility, Mr. Walker's Sugar Industry in the Island of Negros is one of the most important papers published by the Bureau of Science. This volume is a real contribution to the subject; it is not a mere compilation, for the author was in the field and understands the conditions of which he writes.

A MANUAL OF PHILIPPINE SILK CULTURE

By CHARLES S. BANKS

Order No. 413. Paper, 53 pages, 20 plates, \$0.75, postpaid.

In A Manual of Philippine Silk Culture are presented the results of several years' actual work with silk-producing larvae together with a description of the new Philippine race.

THE PHILIPPINE
JOURNAL OF SCIENCE

B. TROPICAL MEDICINE

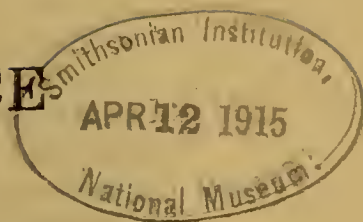

VOL. IX

NOVEMBER, 1914

No. 6

THE GERMICIDAL POWER OF GLYCERIN ON VARIOUS MICRO-
ORGANISMS UNDER VARIOUS CONDITIONS

By E. H. RUEDIGER

(From the Biological Laboratory, Bureau of Science, Manila, P. I.)

Although glycerin is extensively used, especially as a preservative in vaccine virus, very little has been published regarding its germicidal properties. Rosenau¹ seems to be the only one who has made any extensive study of these properties. The use of glycerin as a germ-destroying agent in the preparation of bacterial vaccine introduced by Row² has aroused new interest in the subject. The tests reported here were made in order to obtain accurate information as to the extent that glycerin may be relied upon to sterilize bacterial vaccines.

THE GERMICIDAL POWER OF GLYCERIN IN PHYSIOLOGIC SALT
SOLUTION AT ROOM TEMPERATURE

TEST 1

Eight sets of test tubes were prepared, and the sets were numbered 1, 2, 3, 4, 5, 6, 7, and 8. Each set contained four tubes, *a*, *b*, *c*, and *d*. Into tube *a* were put 2 cubic centimeters of salt solution (9 grams per liter); into tube *b* were put 2 cubic centimeters of 12.5 per cent solution of chemically pure glycerin; into tube *c* were put 2 cubic centimeters of 25 per cent solution of glycerin; and tube *d* received 2 cubic centimeters of 50 per cent solution of glycerin. The tubes with their contents were sterilized in the autoclave. After sterilization the 8 sets of tubes were inoculated with the typhoid bacillus, *Staphylococcus albus*,

¹ *Bull. Hyg. Lab. U. S. Pbl. Hlth. & Mar.-Hosp. Serv.*, Wash. (1913), No. 16.

² *Journ. Trop. Med.* (1913), 16, 293.

TABLE X.—*The action of glycerin in salt solution at room temperature on plague bacillus No. 3.*

Glycerin.	Days.														
	1	2	3	4	5	6	7	8	9	10	11	12	13	14	15
0 per cent.....	+	+	+	+	+	+	+	+	+	+	+	+	+	+	0
12.5 per cent.....	+	+	0	+	0	0	0	0	0	0	0	0	0	0	0
25 per cent.....	+	+	0	0	0	0	0	0	0	0	0	0	0	0	0
50 per cent.....	0	0	0	0	0	0	0	0	0	0	0	0	0	0	0

TABLE XI.—*The action of glycerin in salt solution at room temperature on plague bacillus No. 4.*

Glycerin.	Days.														
	1	2	3	4	5	6	7	8	9	10	11	12	13	14	15
0 per cent.....	+	+	+	+	+	+	+	+	+	+	+	+	+	+	0
12.5 per cent.....	+	+	+	0	0	0	0	0	0	0	0	0	0	0	0
25 per cent.....	+	0	0	0	0	0	0	0	0	0	0	0	0	0	0
50 per cent.....	0	0	0	0	0	0	0	0	0	0	0	0	0	0	0

TABLE XII.—*The action of glycerin in salt solution at room temperature on plague bacillus No. 5.*

Glycerin.	Days.														
	1	2	3	4	5	6	7	8	9	10	11	12	13	14	15
0 per cent.....	+	+	+	+	+	+	+	+	+	+	+	+	+	0	0
12.5 per cent.....	+	+	+	0	0	0	0	0	0	0	0	0	0	0	0
25 per cent.....	+	0	0	0	0	0	0	0	0	0	0	0	0	0	0
50 per cent.....	0	0	0	0	0	0	0	0	0	0	0	0	0	0	0

The results in Tables IX to XII show that the action of glycerin on different strains of plague bacilli varies but slightly; the differences are perhaps not greater than those obtained by suspending the germs in plain distilled water or in plain physiologic salt solution. Of the controls (those kept in physiologic salt solution), 2 strains were found dead on the fourteenth day and the other 2 strains were dead on the fifteenth day.

In 12.5 per cent glycerin 3 strains gave negative results on and after the fourth day, while 1 strain gave a negative result on the third day, and 3 colonies developed on the agar inoculated on the fourth day.

In 25 per cent glycerin 3 strains were killed in two days and 1 strain was killed in three days.

TABLE XVI.—*The action of glycerin in salt solution at a temperature of 15° C. on the bacillus of anthrax.*

Glycerin.	Days.														
	1	2	3	4	5	6	7	8	9	10	11	12	13	14	15
0 per cent.....	+	+	+	+	+	+	+	+	+	+	+	+	+	+	+
12.5 per cent.....	+	+	+	+	+	+	+	+	+	+	+	+	+	+	+
25 per cent.....	+	+	+	+	+	+	+	+	+	+	+	+	+	+	+
50 per cent.....	+	+	+	+	+	+	+	+	+	+	+	+	+	+	+

TABLE XVII.—*The action of glycerin in salt solution at a temperature of 15° C. on the bacillus of plague.*

Glycerin.	Days.														
	1	2	3	4	5	6	7	8	9	10	11	12	13	14	15
0 per cent.....	+	+	+	+	+	+	+	+	+	+	+	+	+	+	+
12.5 per cent.....	+	+	+	+	+	+	+	+	+	+	+	+	+	+	+
25 per cent.....	+	+	+	+	+	+	+	+	+	+	+	+	+	+	+
50 per cent.....	+	+	+	+	+	+	0	0	0	0	0	0	0	0	0

TABLE XVIII.—*The action of glycerin in salt solution at a temperature of 15° C. on the spirillum of cholera.*

Glycerin.	Days.														
	1	2	3	4	5	6	7	8	9	10	11	12	13	14	15
0 per cent.....	+	+	+	+	+	+	+	+	+	+	+	+	+	+	+
12.5 per cent.....	+	+	+	+	+	+	+	+	+	+	+	+	+	0	0
25 per cent.....	+	+	+	+	+	+	0	+	0	0	0	0	0	0	0
50 per cent.....	+	0	0	0	0	0	0	0	0	0	0	0	0	0	0

TABLE XIX.—*The action of glycerin in salt solution at a temperature of 15° C. on the bacillus of diphtheria.*

Glycerin.	Days.														
	1	2	3	4	5	6	7	8	9	10	11	12	13	14	15
0 per cent.....	+	+	+	+	+	+	+	+	+	+	+	+	+	+	+
12.5 per cent.....	+	+	+	+	+	+	+	+	+	+	+	+	+	+	+
25 per cent.....	+	+	+	+	+	+	+	+	+	+	+	+	+	+	+
50 per cent.....	+	+	+	+	+	+	+	+	+	+	0	0	0	0	0

TABLE XXVII.—The action of glycerin in bouillon at room temperature on the bacillus of diphtheria.

Glycerin.	Days.														
	1	2	3	4	5	6	7	8	9	10	11	12	13	14	15
0 per cent.....	+	+	+	+	+	+	+	+	+	+	+	+	+	+	+
12.5 per cent.....	+	+	+	+	+	+	+	+	+	+	+	+	+	+	+
25 per cent.....	+	+	+	+	+	+	+	+	+	+	+	0	0	0	0
50 per cent.....	+	+	+	+	+	+	0	0	0	0	0	0	0	0	0

TABLE XXVIII.—The action of glycerin in bouillon at room temperature on the bacillus of glanders.

Glycerin.	Days.														
	1	2	3	4	5	6	7	8	9	10	11	12	13	14	15
0 per cent.....	+	+	+	+	+	+	+	+	+	+	+	+	+	+	+
12.5 per cent.....	+	+	+	+	+	+	+	+	+	+	+	+	+	+	+
25 per cent.....	+	+	+	+	+	0	0	0	0	0	0	0	0	0	0
50 per cent.....	+	+	+	+	0	0	0	0	0	0	0	0	0	0	0

From the results recorded in Tables XXI to XXVIII we learn that glycerin mixed with bouillon has but feeble germicidal power. In 12.5 per cent of glycerin, all the organisms lived fifteen days. The typhoid bacillus, *Staphylococcus albus*, *Staphylococcus aureus*, and the anthrax bacillus were alive in 25 per cent glycerin at the end of fifteen days. In 50 per cent glycerin the typhoid bacillus live three days, *Staphylococcus albus* lived four days, *Staphylococcus aureus* lived five days, the bacillus of anthrax lived fifteen days, the bacillus of plague lived one day, the spirillum of cholera was found to be dead at the end of one day after inoculation, and the bacillus of diphtheria and the bacillus of glanders lived six days and four days, respectively.

TEST 5

Eight sets of test tubes were prepared as before. Horse serum was used as a diluent for the glycerin. The tubes were inoculated and were kept at room temperature, and for a period of fifteen days a 2-millimeter loopful of bacterial suspension from each tube was transferred to a tube of agar. The results are recorded in Tables XXIX to XXXVI, inclusive.

Tables XXIX to XXXVI show that when diluted with horse serum the germicidal power of glycerin is very feeble. In 12.5 per cent of glycerin in horse serum, the typhoid bacillus, *Staphylococcus albus*, *Staphylococcus aureus*, the bacillus of anthrax, the bacillus of diphtheria, and the bacillus of glanders were alive at the end of fifteen days; the bacillus of plague was dead after ten days, and the spirillum of cholera was found to be dead on the fifteenth day. Twenty-five per cent glycerin killed the typhoid bacillus in fifteen days; *Staphylococcus albus*, *Staphylococcus aureus*, and the bacillus of anthrax were alive on the fifteenth day. The bacillus of plague lived seven days, the spirillum of cholera lived five days, the bacillus of diphtheria lived eleven days, and the bacillus of glanders gave negative results after six days.

In 50 per cent glycerin the typhoid bacillus was alive at the end of twenty-four hours, but negative results were obtained thereafter. *Staphylococcus albus* lived five days; *Staphylococcus aureus*, ten days; and the anthrax bacillus was alive on the fifteenth day. At the end of one day, the bacillus of plague gave a positive result and the spirillum of cholera a negative result. The bacillus of diphtheria and the bacillus of glanders lived five days and three days, respectively.

CONCLUSIONS

Glycerin has a distinct, although feeble germicidal action.

The germicidal action varies greatly with the temperature, being much feebler at a temperature of 15° C. than at from 30° to 35° C.

The germicidal action varies with the diluent employed; in glycerin diluted with physiologic salt solution the microorganisms died much sooner than in glycerin diluted with bouillon or with horse serum.

In dilutions up to 50 per cent, glycerin did not destroy the bacillus of anthrax in fifteen days. This may be due to the presence of spores.

Glycerin seems to be a selective poison for the bacillus of plague, the spirillum of cholera, and the bacillus of diphtheria.

In 50 per cent of glycerin in physiologic salt solution all the nonspore-forming organisms died in less than four days.

THE VITALITY OF THE CHOLERA VIBRIO IN MANILA WATERS

By OTTO SCHÖBL

(From the *Biological Laboratory, Bureau of Science, Manila, P. I.*)

The character of the recent outbreak of cholera in Manila evidenced no indication of being one due to the spread of the infectious agents by means of the water supply.

As water is one of the most important factors in the dissemination of cholera, it was deemed of interest to arrange an orientation experiment as given below.

In order to gain some information as to the vitality of cholera vibrios in Manila waters, the tap water and the sea water were considered. Sterile distilled water was included for comparison.

It is evident from the literature,¹ as well as from theoretical grounds, that the vitality of cholera vibrios in water will be subject to variations owing to different factors, such as, the temperature of water, the chemical composition of water, the competition of cholera vibrios with other bacteria present, the number of cholera vibrios, and the physical condition of the water.

The consideration of the experimental evidence gives a certain general idea as to the vitality of cholera vibrios in water; but owing to the multiplicity of factors involved as well as to the differences in local conditions it is impossible to apply the results of the experience gained elsewhere to local conditions in a particular place. Therefore, it was thought more instructive to arrange a simple experiment under such conditions as might occur in this community.

The following experiments were made:

1. Series of 5 test tubes containing 10 cubic centimeters of distilled water.
2. Series of 5 test tubes containing 10 cubic centimeters of tap water.
3. Series of 5 test tubes containing 10 cubic centimeters of sea water were inoculated in such a way that 1 loopful of cholera fæces (typical rice-water stool) was planted in the first test tube, 3 loopfuls in the second, 5 in the third, and so on.

¹ The results of experiments by various authors regarding the vitality of cholera vibrio in water will be found tabulated in Kolle und Wassermann, *Handbuch der pathogenen Microorganismen* (1903), 1, 196.

The tubes were thoroughly shaken, and a loopful was transplanted from each tube into a test tube containing peptone solution. Every tube gave positive growth of cholera vibrio upon transplant to a plate containing Dieudonné's medium, showing that a sufficient number of cholera vibrios were inoculated into each tube of water to be found in 1 loopful. The tubes containing water polluted with cholera fæces were allowed to stand at room temperature. Sunshine was excluded, but direct daylight had free access.

From time to time a loopful of water was subplanted into peptone solution. From the time the cholera vibrio could no longer be recovered in a loopful, larger quantities were transplanted. The details of the experiment are evident from Table I. Plates of Dieudonné's medium were used exclusively. The experiment was begun in November, 1913, and the one hundred sixth day of the experiment was March 2, 1914; that is to say, the experiment was carried on during the latter part of the cool season.

SUMMARY

The table needs but a few remarks. It shows that the cholera vibrios disappeared from distilled water first and that they were evidently most numerous in the sea water. The room temperature (25° C.) was apparently very favorable. The unexpectedly long period of time during which the cholera vibrios were found alive in the tap water shows that under conditions like those in tube I cholera vibrios may remain alive and multiply for a considerable length of time. It is also evident from the table that the vibrios remained alive in less-polluted water (tube I) longer than in the heavily polluted water (tube IX).

The theoretical possibility in the Philippine Islands of introducing Asiatic cholera from port to port by means of water carried on board of ships and of maintaining a source of infection in waters polluted with human excreta thus finds experimental corroboration.

THE MORPHOLOGY OF THE ADULTS OF THE FILARIA FOUND IN THE PHILIPPINE ISLANDS

By ERNEST LINWOOD WALKER

(From the Biological Laboratory, Bureau of Science, Manila, P. I.)

One plate

Ashburn and Craig (1906) described the larval filariæ found in the blood of a native of the Philippine Islands as a new species, *Filaria philippinensis*. The diagnosis of the new species was based on the study of the larvæ from a single case of infection. In 1907 these authors made a study of four additional cases of filariasis in the Philippines, which they decided were infected with the same species, and they performed some experiments on the development and transmission of this species by the mosquito, *Culex fatigans*. Ashburn and Craig distinguish *Filaria philippinensis* from the hitherto described species by certain peculiarities in the morphology and the lack of periodicity of the larvæ. Furthermore, they believe it to be the only indigenous species, because the previous descriptions of filarial larvæ observed in natives of these Islands contain nothing which would exclude the possibility that the observers were dealing with *Filaria philippinensis*.

Phalen and Nichols (1908 and 1909) made somewhat extended observations on the occurrence and distribution of filariasis and elephantiasis in the Philippine Islands. They found both to be more prevalent and widespread than the observations of Ashburn and Craig would indicate. Moreover, they found a distinct nocturnal periodicity in the appearance of the larval filariæ in the peripheral circulation in all of their cases, and they concluded that the larvæ in all of the cases studied by them corresponded to the larvæ of *Filaria bancrofti* Cobbold.

Recently Dr. J. W. Smith (1914), chief sanitary officer of Bilibid Prison, has had an extensive series of blood examinations made of the prisoners in that institution. These prisoners come from all parts of the Philippine Islands. The examinations were made of blood taken both during the day and at night. *Filaria* infection was found in about 6 per cent of the prisoners. The larval filariæ have been found to exhibit a distinct nocturnal

periodicity in all cases. While elephantiasis or other clinical symptoms of infection with filaria are not common in this institution, they are by no means unknown.

The identification of the species of the Philippine filaria both by Ashburn and Craig and by Phalen and Nichols was based upon the study of larval forms alone. Several pathologists working in the Philippines, including Calvert (1902), Bowman (1911), and Crowell,¹ have observed sections of adult filaria in the tissues, but so far as I am aware no intact adults have hitherto been discovered.

I am indebted to Dr. J. W. Smith for the adult filariæ described in this paper which were obtained from a cyst removed surgically by his assistant, Doctor Mañalak, from the inguinal region of a Filipino in the hospital of Bilibid Prison. This man was a native of Rizal Province and had, so far as known, never been outside of the Philippine Islands. Examinations of his blood for filarial embryos, both day and night, nine days before and on the day of the operation were negative. The cyst removed contained 1 adult male and 3 adult female filariæ. One of the females was broken in removing it from the cyst; the other 2 females and the male were secured intact.

The worms were washed in physiological salt solution, fixed in hot 70 per cent alcohol, and preserved in 70 per cent alcohol containing 5 per cent of glycerin. They were prepared for examination by evaporating the alcohol from the glycerin-alcohol mixture and then mounting each in pure glycerin on a large slide, under a large cover glass supported by pieces of glass at each corner to prevent crushing the worm.

The anatomy of these filariæ, together with measurements, has been very thoroughly described, because it is believed that only by such careful descriptions can the identity of the filariæ of different countries be determined. There is a noteworthy lack of careful and thorough work on the hitherto described adult filaria, and it is intended that the following description shall be accurate and complete for the species and serve for comparison with the other filariæ.

DESCRIPTION OF THE FILARIÆ

I. THE FEMALE

General.—A long, slender, cylindrical, white worm. The anterior end tapers slightly to a short neck, and terminates in a

¹ Not yet published.

slightly bulbous head which is flattened anterioposteriorly (Plate I, fig. 1). The posterior end is straight or slightly curved. It tapers slightly to a bluntly rounded tail which is not bulbous (Plate I, fig. 3). The lateral lines are not apparent. The cuticle shows exceedingly fine cross striations which vary in distinctness in different parts of the worm. The head bears laterally 2 series of tiny papillæ. No circumanal papillæ are apparent (Plate I, fig. 3). The measurements of the two intact females are as follows:

TABLE I.—*External measurements of 2 female filariæ.*

Measurement.	No. 1.	No. 2.
	<i>mm.</i>	<i>mm.</i>
Length	84.0	81.0
Greatest thickness	0.2268	0.2268
Diameter of head	0.063	0.058
Diameter of neck	0.0567	0.0518
Diameter of end of tail	0.044	0.045
Distance from head to vulva	0.729	0.79
Distance from anus to end of tail	0.21	0.2

Intestinal tract.—The mouth is terminal and minute, and does not appear to be surrounded by any appendages. There is a slight thickening of the cuticle lining the mouth (Plate I, fig. 2). It opens into a long slender œsophagus, which is slightly enlarged posteriorly and which is from 1.13 to 1.34 millimeters in length. It is slightly constricted at its junction with the intestine (Plate I, fig. 1). The slender intestine, which is of approximately uniform diameter, runs practically straight the whole length of the body to the anus, which opens on the ventral side at a point from 0.20 to 0.21 millimeter from the end of the tail (Plate I, fig. 3).

Reproductive organs.—The vulva is situated anteriorly on the ventral surface, at a point from 0.729 to 0.77 millimeter from the anterior end. There is a slight protuberance at the opening which appears to be two lipped (labium). The vulva opens directly into the vagina, which is enlarged at its anterior end into a pear-shaped organ (receptaculum seminis) placed more or less obliquely and measuring 0.178 millimeter long by 0.06 millimeter broad (Plate I, fig. 1). From the receptaculum seminis the vagina extends backward from 6.5 to 6.8 millimeters. At first straight and slender it makes one or two loops just behind the junction of the œsophagus with the mid-gut and

gradually enlarges until it occupies almost the entire body cavity. In these specimens the enlarged posterior part is filled with young larvæ.

The posterior, enlarged, end of the vagina branches to form the two uteri (Plate I, fig. 4), which extend side by side straight backward nearly the whole length of the worm, occupying the entire body cavity except for the slender intestine; they are filled with larvæ and ova containing larvæ. At a distance of from 5.9 to 11.6 millimeters from the posterior end of the worm the uteri become abruptly contracted to be continued as the slender ovaries. The uteri do not always become constricted to form the ovaries at the same point. Thus in female No. 2, one uterus gives rise to the ovary at 8.4 millimeters and the other at 11.5 millimeters from the posterior end of the worm.

The two ovaries form one or two loops upon themselves, and extend to within from 4.8 to 1.4 millimeters of the posterior end of the worm. The anterior part of the ovaries are empty tubes, but the posterior, distal, ends are filled with partially developed ova and undifferentiated protoplasm.

The ovum is oval in outline, and contains the immature larva. The ova measure from 45 to 47 microns in length and from 27 to 29 microns in breadth.

The free intrauterine larvæ (immature) measure from 213 to 233 microns in length, exclusive of the sheath, and from 4.7 to 5.8 microns in breadth. The larva is inclosed in a sheath which extends beyond the caudal and cephalic ends and which is sufficiently loose to permit of forward and backward movements of the larva within it. The tail of the larva is tapering and pointed.

II. THE MALE

General.—The male is shorter and slenderer than the female filaria. It tapers slightly at both the anterior and posterior ends. The tapering anterior end is slightly enlarged into a bulbous head, which is flattened anteroposteriorly (Plate I, fig. 4) and bears laterally 2 rows of papillæ that are even more minute than in the female. The posterior end is spirally coiled two and one-half to three times (Plate I, fig. 5). There are no apparent lateral lines. The male shows transverse striations of the cuticle much less distinctly than the female; in fact, the striations are apparent only at certain curves of the coiled tail. There are 3 pairs of postanal and numerous pairs—at least 32—of

preanal papillæ, which are very small and difficult to distinguish (Plate I, fig. 5).

TABLE II.—*External measurements of the male filaria.*

	Millimeters.
Length (exclusive of coiled tail)	33.0
Greatest thickness	0.126
Diameter of head	0.0486
Diameter of neck	0.0437
Diameter of end of tail	0.034
Distance from cloaca to end of tail	0.129

Intestinal tract.—The mouth, as in the female, is terminal. It opens into the long slender œsophagus of approximately uniform diameter, which extends straight backward 1.23 millimeters. It is slightly constricted at its junction with the mid-gut. The intestine is slender, of approximately uniform diameter, and runs nearly straight the whole length of the body of the worm. It enters the cloaca which opens on the ventral side of the worm at 0.129 millimeter from the posterior border of the curved tail.

Reproductive organs.—The genital organs of the male consist of an elongated testis which is continuous with the spermatic duct and opens into the cloaca, the whole constituting a single cylindrical organ running ventrally nearly the entire length of the worm. The proximal end of the spermatic duct consists of a narrow, muscular *ductus ejaculatorius*, opening into the cloaca. The spermatic duct then becomes gradually dilated to form the seminal vesicle, which is from one-third to one-half of the diameter of the body cavity. This is continued into the slightly more dilated, long cylindrical testis which almost completely fills the body cavity and extends to within 1.7 millimeters of the anterior end, or to within 0.469 millimeter from the posterior end of the œsophagus. The distal (anterior) end of the testis tapers somewhat and terminates in a bluntly barbed end. The accessory genital organs consist of 2 spicular sacks situated laterally to the cloaca, containing spicules which are of unequal length (Plate I, fig. 5).

COMPARISON OF THE PHILIPPINE WITH OTHER ADULT FILARIA

The complete measurements of the adult Philippine filaria and, for comparison, the measurements, so far as they are given, of the hitherto described species of human filaria are given in Table III.

TABLE III.—Measurements in millimeters of adult flarix infecting man.

Measurement.	Philippine flaria.	Fiji flaria.	Filaria bancrofti.	Filaria perstans.	Filaria (Loa) loa.	Filaria demarquayi.	Filaria magalhaesi.	Filaria ozzardi.
1. Female:								
Length.....	81.0 - 84.0	50.0 - 67.0	80.0 - 95.0	70.0 - 80.0	30.0 - 40.0	55.0 - 85.0	155.0	81.0 (65-160)
Greatest diameter.....	0.22	0.15- 0.225	0.20 - 0.25	0.12	0.57	0.21- 0.25	0.5 - 0.8	0.21
Diameter of head.....	0.055- 0.063	-----	0.055	0.07	-----	0.09- 0.1	-----	0.05
Diameter of neck.....	0.051- 0.056	-----	0.049	0.02	-----	0.03	-----	0.089
Diameter of end of tail.....	0.044- 0.045	-----	-----	-----	-----	-----	-----	-----
Length of cesophagus.....	1.13 - 1.84	-----	-----	-----	-----	-----	-----	-----
Anus to end of tail.....	0.20 - 0.21	0.21- 0.24	0.225- 0.28	0.145	-----	-----	-----	-----
Vulva to head.....	0.729- 0.77	-----	0.71 - 1.27	0.60	2.5	0.76	0.13	0.23
Length of receptaculum seminis.....	0.178	-----	-----	-----	-----	-----	-----	0.71
Breadth of receptaculum seminis.....	0.05	-----	-----	-----	-----	-----	-----	-----
Length of vagina.....	6.58 - 6.98	-----	-----	-----	-----	-----	-----	-----
Length of uteri.....	65.19 - 67.79	-----	-----	-----	-----	-----	-----	-----
Posterior loop of ovaries to end of tail.....	1.4 - 4.8	-----	-----	-----	-----	-----	-----	-----
2. Male:								
Length.....	83.0	25.0 - 29.0	40.0 - 44.0	45.0	25.0 - 30.0	-----	83.0	45.0
Greatest diameter.....	0.126	0.09- 0.1296	0.10	0.06	0.30	-----	0.25- 0.40	0.05
Diameter of head.....	0.049	-----	-----	0.04	-----	-----	-----	-----
Diameter of neck.....	0.044	-----	-----	-----	-----	-----	-----	-----
Diameter of end of tail.....	0.084	-----	-----	-----	-----	-----	-----	-----
Length of cesophagus.....	1.23	-----	-----	-----	-----	-----	-----	-----
Anus to end of tail.....	0.129	-----	0.138	-----	-----	-----	0.11	-----

While the measurements of filaria vary with the maturity of the specimens measured, and there exists considerable discrepancy in the dimensions of the same species as given by different authors, yet we can, I believe, at least exclude by these measurements the identity of the Philippine filaria with *Filaria (Loa) loa* and *Filaria magalhaesi*. *Filaria (Loa) loa* is further excluded by the presence of rounded bosses on the cuticle, by the absence of a spirally twisted tail in the male, by the presence of 4 well-marked papillæ of peculiar form on each side of the ventral surface of the tail, and by the relatively great distance of the vaginal opening from the anterior end; and *Filaria magalhaesi*, by the habitat of the adult in the left ventricle of the heart, by the presence of 4 pairs of preanal and 4 pairs of post-anal papillæ in the male, and by the relatively great distance of the vaginal opening from the anterior end.

Filaria perstans is excluded by the triangular cuticular appendage of the tail, by the absence of 2 unequal spicules in the male, and by the characters of the larvæ, which are small and blunt-tailed and possess no sheath.

Filaria demarquayi differs from the Philippine species in the greater diameter of the head, in the tail which tapers abruptly behind the anal papillæ, in the marked cuticular thickening at the tip of the tail, and in the small size and absence of a sheath in the larva.

Filaria ozzardi is excluded from the identity of our species by the bulbous end of the tail and by the small size and absence of a sheath in the larva.

The Fijian filaria is believed by Bahr (1912), who has recently investigated filariasis in the Fiji Islands on a commission from the London School of Tropical Medicine, and by Leiper, helminthologist of the London School of Tropical Medicine, to whom adult worms were submitted, to be *Filaria bancrofti*, in spite of the absence of periodicity in the peripheral blood displayed by the larvæ. Bahr believes that this lack of periodicity of the filarial larvæ in the Fiji Islands is due to a partial adaptation of the parasite to its commonest transmitting host, *Stegomyia pseudoscutellaris*, a mosquito which feeds by day only.

the Philippine filaria is identical with *Filaria bancrofti* or (2)

Therefore, there remain two possibilities; namely, (1) that that it is a new species, as was believed by Ashburn and Craig. I believe that the former possibility is the truth.

There are no characters that preclude the identity of the Philippine filaria with *Filaria bancrofti*. The small size of the intrauterine larvæ is evidently due to their immaturity. On the

other hand, all of the essential characters of the Philippine filaria correspond to those of *Filaria bancrofti*. The more important of these characters are: (1) General, (a) size, (b) shape, (c) head bearing 2 series of tiny papillæ, (d) slight thickening of the cuticle lining the mouth, (e) delicate cross striations of the cuticle which vary much in distinctness; (2) *female*, (a) position of the vulva, (b) the pyriform enlargement of the terminal portion of the vagina (receptaculum seminis), (c) the absence of anal papillæ; (3) *male*, (a) the tendril-like coiling of the tail with an incurved end, (b) 2 dissimilar spicules, (c) the presence of 3 pairs of postanal papillæ and their size, shape, and position, (d) the presence of numerous (about 32) pairs of minute preanal papillæ; and (4) *larva*, (a) a pointed tail and (b) the possession of a sheath. In the literature available here, I have been unable to find any detailed description of the internal anatomy of *Filaria bancrofti*; therefore, I am unable to compare the details of the anatomy of this species with that of the Philippine filaria. However, on the basis of external characters, especially of head and tail and their appendages, which are generally used for classifying adult filaria, the Philippine filaria appears to be identical with *Filaria bancrofti*. This decision, based on the study of these specimens from one patient, does not preclude the possibility of another species of filaria existing here, but in conjunction with the evidence of recent studies of the larval forms it renders it extremely improbable, and it establishes definitely for the first time the existence of *Filaria bancrofti* in the Philippine Islands.

LITERATURE REFERRED TO IN THE TEXT

- ASHBURN, P. M., and CRAIG, C. F. A new blood filaria of man: *Filaria philippinensis*. *Am. Journ. Med. Sci.* (1906), n. s. 132, 435-443.
- IDEM. Observations upon *Filaria philippinensis* and its development in the mosquito. *Phil. Journ. Sci., Sec. B* (1907), 2, 1-14.
- BAHR, P. H. Filariasis and elephantiasis in Fiji. *Journ. Lond. School Trop. Med.* (1912), Suppl. 1.
- BOWMAN, F. B. A case of dysentery caused by *Balantidium coli* with coincident filarial infarction of the spleen. *Phil. Journ. Sci., Sec. B* (1911), 6, 147-153.
- CALVERT, W. J. A preliminary report on the blood in two case of filariasis. *Bull. Johns Hopkins Hosp.* (1902), 13, 23.
- LEIPER, P. T. See Bahr, 1912.
- PHALEN, J. M., and NICHOLS, H. J. Filariasis and elephantiasis in southern Luzon. *Phil. Journ. Sci., Sec. B* (1908), 3, 293-303.
- IDEM. The distribution of filaria in the Philippine Islands. *Ibid.* (1909), 4, 127-135.
- SMITH, J. W. Some clinical observations on filariasis in Bilibid Prison. Read before the Manila Medical Society, April 6, 1914.

ILLUSTRATIONS

PLATE I

(The figures in Plate I, with the exception of fig. 2, were all drawn with a Zeiss AA objective, 3 ocular, and tube length of 160 millimeters, and with the aid of a camera lucida. Fig. 2 was made with a Zeiss DD objective. The figures are all reduced to one-fourth size of drawings. The drawings are somewhat diagrammatic in order to bring out clearly the essential structures. Drawn by T. S. Espinosa.)

- FIG. 1. Cephalic end of female of *Filaria bancrofti*, showing the anterior portions of the alimentary tract and generative organs.
2. Cephalic end of the female of *Filaria bancrofti*, more highly magnified, showing the details of the structure of the head.
 3. Caudal end of the female of *Filaria bancrofti*. Note the position of the anus and the absence of anal papillæ.
 4. Cephalic end of the male of *Filaria bancrofti*. Note the constriction of the alimentary tract at the junction of the œsophagus with the mid-gut.
 5. Caudal end of the male of *Filaria bancrofti*. Note the tendril-like coiling of the tail, the three postanal and the numerous minute preanal papillæ, the spermatic duct (dorsal) and the intestine (ventral) opening into the slightly dilated cloaca, the opening of the cloaca, and the extended spicule (the other shorter spicule lies under the one shown in the figure).



Fig. 1. Cephalic end of female.



Fig. 3. Caudal end of female



Fig. 4. Cephalic end of male.



Fig. 2. Cecephalic end of female.



Fig. 5. Caudal end of male.

PLATE I. MORPHOLOGY OF FILARIA BANCROFTI.

PELVIMETRY AND CEPHALOMETRY AMONG FILIPINAS

By HONORIA ACOSTA-SISON

(From the Department of Obstetrics, College of Medicine and Surgery,
University of the Philippines)

Practically no previous systematic measurements of the pelvis in Filipinas have been performed, those cases only having been measured in which the physician was confronted with a gross pelvic abnormality from osteomalacia or rickets or with a case of difficult labor. Apparently, also, no studies have been made of the relationship in size between the pelvis of the Filipino mother and the head of the infant. This may be explained by the facts that until recently untutored midwives had almost the entire control of the maternity cases; that the prospective mothers traditionally do not consult a physician until the midwife has failed to bring forth the baby and the patient is near death; and that until two and a half years ago there did not exist large charity hospitals with modern equipment and facilities such as are now found in the Philippine General Hospital.

It has been asserted by different investigators, such as Stratz,(9) Topinard,(10) Waldeyer,(11) Riggs,(6) and others, that the pelvis of the less civilized races is narrower and deeper than that of the Caucasian race; and writers, such as Engelman,(2) Scharlau,(8) Ploss,(5) and Gache,(3) have observed the comparatively easy labors of primitive people.

The literature concerning the Filipino pelvis consists of a description of a case of osteomalacia by Baldomero Roxas,(7) and one of an osteomalacic pelvis by José Montes.(4) However, there are no articles dealing with the normal Filipino pelvis.

Purpose.—The present study has been undertaken with the purpose of investigating the Filipino pelvis and its relationship to the child's head and also to establish a comparison between the Filipino and European pelvis. It was attempted at the suggestion and with the assistance and advice of Dr. Fernando Calderon, who kindly consented to measure the diagonal conjugate of all the cases reported below.

Material.—The material on which this study is based consists of the records of 181 women and 117 babies who were patients in the obstetrical department of the Philippine General Hospital during the period from November, 1913, to February, 1914. To insure accuracy in figures, only the cases personally measured by us have been used. There have been eliminated 2 cases of generally contracted pelvis, 2 cases of flat pelvis, and all cases in which labor resulted in premature or multiple babies. The figures of Riggs, who has studied this subject extensively, have been used to establish a comparison between the European or American pelvis and that of the Filipina. Riggs's normal measurements were averaged from 707 white women and children. The diameters of the pelvic outlet, however, have been taken from Edgar,⁽¹⁾ as they have not been included in Riggs's work.

Method of measurement.—The measurements of the external diameters have been taken with the tips of the pelvimeter placed just opposite the bone and not in the outer or inner lip of the ilium. In taking Baudelocque's diameter, the closest proximity to the bone was attempted and the anterior tip of the pelvimeter was placed on the upper border of the symphysis pubis rather than on its anterior surface. The anteroposterior diameter of the pelvic outlet has been measured from the lower border of the symphysis pubis to the sacrococcygeal articulation. These points were chosen because the coccyx is movable, at least in our reported cases, and they, therefore, practically represent the shortest distance in the anteroposterior diameter of the pelvic outlet.

TABLE I.—Comparison of the pelvic measurements in American and Filipino women.

Measurement.	American, 707 cases (Riggs).	Filipino, 181 cases.	Difference.
	<i>cm.</i>	<i>cm.</i>	<i>cm.</i>
Spine.....	25.47	23.9	1.47
Crest.....	27.998	24.91	3.088
Trochanters.....	30.90	28.103	2.797
Baudelocque's.....	19.71	17.63	2.08
Diagonal conjugate.....	12.26	12.00	0.26
Anteroposterior diameter of the pelvic outlet.....	^a 12.5	10.05	2.44
Transverse diameter of the pelvic outlet.....	11.00	11.00

^a Edgar.

TABLE II.—*Comparison of the cephalic measurements in American and Filipino infants.*

Measurement.	American, 707 cases (Riggs).	Filipino, 117 cases.	Difference.
	<i>cm.</i>	<i>cm.</i>	<i>cm.</i>
Occipitomenal	13.33	12.11	1.22
Occipitofrontal	11.707	10.96	0.747
Suboccipitobregmatic	9.70	9.28	0.42
Biparietal	9.25	8.63	0.62
Bitemporal	8.00	6.829	1.171
Occipitomenal circumference		36.56	
Occipitofrontal circumference		32.04	
Suboccipitobregmatic circumference	32.17	30.26	1.91

Table I shows that the diameters of the Filipino pelvis are shorter than those of the American or European pelvis. On studying this table closely, one finds that the relation of one diameter to another is altered in such a way that the proportion of the crests with the spines in the Filipino pelvis is much smaller than the proportion of the same diameters in the European or American pelvis and that the proportion of the diagonal conjugate with the other diameters in the Filipino is very slightly larger than in the American. This would seem to show that the Filipino pelvis is narrower and relatively slightly deeper than the American pelvis. This diminution may be explained by the small stature of the Filipinas. However, the most striking difference is that, although the Filipino pelvis is smaller than the American pelvis, the transverse diameter of the pelvic outlet is the same as that of the Caucasian race.

To find an explanation for this peculiarity would take us back to the mechanical theory of the production of the shape of the human pelvis. It is well known that the pelvis of the child alters in shape in proportion to mechanical influences such as that of osteomalacia. It is also an established fact that the sitting posture flares out the ischial tuberosities, and this is proved in some cases of osteomalacia where the patient has maintained the sitting posture for a long time. In applying this theory in our cases, it must be remembered that the Filipino woman from her childhood has habitually accustomed herself to the squatting position or to sitting on the hard floor with the knees drawn up, and her occupation is such that she is obliged to be in this position for nearly the whole day. Whether she sews, cooks, washes, or sells in the market, she nearly always assumes this position.

The squatting position has a greater tendency to flare out the ischial tuberosities than has the ordinary sitting posture on the chair, for in the former not only the body weight but also the weight of the thighs is transmitted to the ischial tuberosities. Perhaps the custom of carrying the child astride the mother's or nurse's hip may also have an effect toward the enlargement of the transverse diameter of the pelvic outlet.

Table II shows the cephalic diameters of the Filipino and American child. As may be noticed, all cephalic diameters of the Filipino child are smaller by slightly over 0.5 centimeter to compensate for the undersized pelvis. Moreover, the occipitomenal and bitemporal diameters are over 1 centimeter shorter. The diminution of the cephalic diameters may also be explained, aside from the pelvic accommodation, by the small stature of the Filipinas. It has been asserted by most observers that the child of the primipara is smaller than are those of the multipara, but in our work we have made no attempt to determine this point.

CONCLUSIONS

From the above findings, it seems justifiable to establish the following conclusions:

1. That the Filipino pelvis is smaller than the American or European pelvis and that this may be explained by the smaller stature of the Filipinos as a race.

2. That the transverse diameters of the Filipino pelvis, except the transverse diameter of the pelvic outlet, are smaller than those of the European or American pelvis.

3. That the relative enlargement of the transverse diameter of the pelvic outlet may be explained by the habitual squatting position that the Filipino woman assumes and by the fact that the carrying of the child astride the mother's or nurse's hip may also affect the child in the transverse diameter of its pelvic outlet.

4. That the head of the newborn is proportionate with the Filipino pelvis.

5. That the cephalic diameters of the Filipino child are smaller than those of the American child by a little over 0.5 centimeter, with the exception of the occipitomenal and bitemporal diameters, where the shortage is over 1 centimeter.

REFERENCES

- (1) EDGAR, J. C. *The practice of obstetrics*. P. Blakiston's Son & Co., Philadelphia (1907).
- (2) ENGELMAN, G. J. *Labor among primitive peoples* (1883). Cited by Riggs.

- (3) GACHE, S. La rachitism en Amérique et son influence obstetricale. *Ann. gyn. et d'obst.* (1903), 60, 175. Cited by Riggs.
- (4) MONTES, JOSÉ. *Rev. Filipina med. y farm.* (1912), 3.
- (5) PLOSS, H. Das Weib in der Natur und Völkerkunde. IV. Aufl. (1895), 1, 134. Cited by Riggs.
- (6) RIGGS. A comparative study of white and negro pelves with a consideration of the size of the child and its relation to presentation and character of labor in the two races. *Johns Hopkins Hospital Rep.* (1904), 12, 421.
- (7) ROXAS, BALDOMERO. Un caso interesante de sección cesarea clasica por pelvis osteomalacica. *Rev. Filipina med. y farm.* (1911), 2, 1.
- (8) SCHARLAU, B. Das Australier-Becken, Berlin (1903). Cited by Riggs.
- (9) STRATZ, C. H. Die Frauen auf Java, Stuttgart (1907). Cited by Riggs.
- (10) TOPINARD. Des proportions générales du bassin chez l'homme, etc. *Bull. Soc. d'anthrop.* (1875), 504. Cited by Riggs.
- (11) WALDEYER. Cited by Riggs.

A NOTE ON THE PHYSIOLOGICAL ACTION OF THE PROTEOSES

By R. B. GIBSON

(From the Department of Physiology, College of Medicine and Surgery,
University of the Philippines)

In mixed proteoses obtained by the gastric digestion of pure proteins, I observed (in 1902) that the filtrate from the hot alcohol-precipitated preparation still contained much proteose. The effect of such alcohol-soluble proteoses (ovalbumoses, edestinoses, caseoses) on the heart and on body temperature have already been reported.¹

While preparing, on another occasion, the peptic proteoses of crystallized ovalbumin, the hot alcoholic filtrate from the dialized and concentrated proteoses was left on the laboratory table. On cooling, the precipitate had a peculiar granularlike appearance. Under the microscope, it was observed that the precipitate consisted of minute spherules which resembled closely those found in the intermediate phase of the slow crystallization of ovalbumin.² A barely sufficient amount of this material was obtained to try the effect on blood pressure with a very small dog. The fall of blood pressure typical of proteoses was noted, but blood clotting was not effected in this experiment.

This new method for the preparation of certain proteoses has made it of interest to study the physiological action of the products so obtained. Particularly is this so, as Pick and Spiro³ and Popielski⁴ and his associates have indicated that the so-called "peptone" shock of the earlier writers may be due to some impurity in the proteoses employed. Underhill⁵ has shown that Pick and Spiro's conclusions are untenable. However, their work is still quoted in much of the literature as final,⁶ and seems

¹ Gibson and Schultz, *Journ. Pharm. & Exp. Therap.* (1909-10), 1; Gibson, *This Journal, Sec. B* (1913), 8, 475.

² Hofmeister, *Zeitschr. f. physiol. Chem.* (Hoppe-Seyler) (1889), 14, 165.

³ *Ibid.* (1900), 31, 235.

⁴ *Arch. f. d. ges. Physiol.* (Pflüger) (1907), 120, 451; *ibid.* (1908), 121, 239; *ibid.* (1909), 126, 483; also Czubalski, *ibid.* (1908), 121, 395; Gizelt, *ibid.* (1908), 123, 540; Popielski, *Zeitschr. f. Immunitätsforsch., Orig.* (1913), 18, 562. See also Zuntz, E., *Compt. rend. Soc. biol.* (1913), 73, 50.

⁵ *Am. Journ. Physiol.* (1903), 9, 345.

⁶ Cf. Cecil, *ibid.* (1911), 24, 156.

to be substantiated by Popielski who ascribes the active physiological principle of Witte's peptone to an alcohol-soluble impurity, "vasodilatine."

A study of the alcohol-soluble proteoses should go far toward clearing up the problem as to whether "peptone" shock is really due to the proteose itself or to alcohol-soluble impurities. It would be expected a priori that, if such an alcohol-soluble substance is really present with the proteose, the process of separation with alcohol would yield a nonactive product or that the active principle, if it is deposited on cooling, would be much more concentrated. If the physiological effects are essentially unchanged, it would be justifiable to conclude that these are characteristic of the proteose per se.

Accordingly, 500 grams of Witte's peptone were extracted with about 3 liters of hot 80 to 85 per cent alcohol. The alcohol was filtered off on a hot water funnel, allowed to cool slowly, and then placed in the ice box. A small amount of proteose separated out with the characteristic spherule formation. This residue was filtered, pressed out between dry filters, and preserved. The filtrate was poured over the original proteose residue, and the procedure was repeated. After numerous extractions, the residues were redissolved in water and dried on the water bath; about 60 grams of hot alcohol-soluble proteoses (preparation 1) were obtained.

The reëxtraction of the original residue with fresh alcohol was then undertaken, and about 50 grams more of the alcohol-soluble proteoses were obtained. This material was again redeposited from a repeated hot alcoholic extraction until about 40 grams of proteose (preparation 2) were recovered. After every extraction, the deposit was spherular in character.

The yield from Witte's peptone was then over 20 per cent. The final products were obtained as fine white powders, supposedly proteoses. They give a typical (not pink) biuret reaction, a Millon's test, a strong Hopkins-Cole reaction, and contain a small amount of loosely combined sulphur. They are completely soluble to almost colorless solutions in hot water, but concentrated solutions yield a slight deposit of spherules on cooling and standing. They are precipitated by absolute alcohol. Unlike other proteoses or proteins, they may be dried on the water bath to an easily friable residue. The process of separation is a tedious one; nearly three weeks were required to complete the above preparations.

When injected intravenously into dogs, both preparations

produced the typical fall in blood pressure and inhibition of blood clotting. The amounts necessary to give these results are the same as those usually described (0.3 to 0.5 gram per kilogram of body weight).⁷ No essential difference was noted between the effects of preparation 1 and the purer preparation 2.

Proteose preparation 1.—June 24, 1914. Dog, male, weighing 4.9 kilograms. Blood samples obtained at 10.30 a. m. clotted in fifteen minutes. Blood pressure at 10.39 a. m. was 130 millimeters. At 10.40 a. m., the dog received an injection into the saphenous vein of 2 grams (in 20 cubic centimeters of water), or 0.4 gram per kilogram of body weight of the alcohol-soluble proteoses. Blood pressure fell rapidly at first and then slowly to 30 millimeters of mercury; at 10.45 a. m. it was 50 millimeters only. Blood samples collected in duplicate at 10.45 a. m. and 10.50 a. m. failed to clot. Blood pressure at 11.00 a. m. and 11.05 a. m. had risen to 62 and 92 millimeters of mercury. Blood samples obtained at 11.26 a. m. clotted after twenty-five minutes.

Proteose preparation 2.—June 25, 1914. Dog, female, weighing 8.2 kilograms. Blood samples obtained at 12.03 p. m. clotted in fourteen minutes. Blood pressure at 12.04 p. m. was 148 millimeters of mercury. At 12.05 p. m. the dog received an intravenous injection as above of 3.5 grams of the proteoses (0.4 gram per kilogram of body weight) in 40 cubic centimeters of water. Blood pressure fell regularly to 24 millimeters of mercury. At 12.06 p. m. the blood pressure was still 24 millimeters of mercury. Blood samples obtained at 12.10 p. m. and 12.15 p. m. failed to clot. Blood pressures at 12.20 p. m., 12.25 p. m., and 12.30 p. m. were 60, 72, and 100 millimeters of mercury, respectively. Blood samples collected at 12.36 p. m. still failed to clot.

CONCLUSIONS

1. The preparation of semicrystalline alcohol-soluble proteoses from Witte's peptone is described.

2. When injected intravenously into dogs, these proteoses produce the typical fall in blood pressure and inhibition of blood clotting which have been repeatedly described for other proteose preparations.

⁷ Schmidt-Mülheim, *Arch. f. Physiol.* (1880), 33; Fano, *ibid.* (1881), 277; Chittenden, Mendel, and Henderson, *Am. Journ. Physiol.* (1899), 2, 149; Underhill, *loc. cit.*, and others.

3. The amount of the alcohol-soluble proteose necessary to produce these effects (0.4 gram per kilogram of body weight) shows that in the process of separation there has been neither concentration nor loss of the active physiological principle. The more purified proteose was not less effective than the cruder preparation. This action must then be ascribed to the proteoses themselves and not necessarily to an alcohol-soluble impurity.

I wish to thank Dr. Isabelo Concepción for the assistance which he has rendered me both in the preparation of the proteoses and in the carrying out of the blood-pressure experiments.

THE LYMPHAGOGIC ACTION OF THE PHILIPPINE MANGO, MANGIFERA INDICA LINNÆUS

By R. B. GIBSON and ISABELO CONCEPCIÓN

(From the Department of Physiology, College of Medicine and Surgery,
University of the Philippines)

The transient rashes occurring in the Philippines during the hot season are often popularly ascribed to eating the Philippine mango, *Mangifera indica* L., which ripens at this time. The mango seems to intensify the ordinary "prickly heat" symptoms, and individuals in the Islands who have a tendency to this affection often find relief when they eliminate the fruit from their dietary. We have also had occasion to observe that the nursing child may be affected when mangos are eaten by the mother; these observations will be reported in a separate paper by one of us (Concepción).

The almost universal distribution of the mango in tropical countries and the large part that the fruit shares in tropical dietaries make the problem of "mango rash" an important one. Such rashes are commonly ascribed to the mango by the Philippine practitioners of medicine, but we have been unable to find any description of these effects in the literature. The present investigation was carried on to get some experimental evidence as to whether or not the mango is to be classed with such rash-producing substances as crustaceans, mollusks, etc., which Heidenhain¹ designated physiologically as lymphagogues of the first class.

The lymphagogues of the first class include "peptone," albumen, extracts of liver and intestine, and especially extracts of crustaceans, mollusks, and leeches. The physiological effects are a marked fall in blood pressure, an increased flow of lymph richer in solids than the normal, an inhibition of the clotting power of the blood, deep narcosis, anuria, and increased secretory action of the pancreas, salivary glands, and liver. Subsequent injections are progressively less effective. The apparent similarity of the effects of the lymphagogues of the first class with anaphylactic shock is of extreme interest. This similarity has been repeatedly pointed out.

¹ *Arch. f. d. ges. Physiol.* (Pflüger) (1891), 49, 209.

Rashes sometimes occur after the ingestion of strawberries, and a lymphagocic effect for these has been demonstrated by Clopatt² and by Mendel and Hooker.³ Our work has shown conclusively that the mango is also to be included with Heidenhain's lymphagogues of the first class.

Dogs, anæsthetized with ether only, were used in the 14 experiments performed. Extracts of the dried mango pulp (3 experiments) were less effective than the strained and centrifugalized raw juice which we employed in the remainder of the series. Mendel and Hooker arrived at a similar conclusion with strawberry extracts. Lymph was collected from the thoracic duct. The dogs had not been fed since the day preceding. Injections of the mango juice, at 30° C., were made from a burette into the saphenous vein. Determinations of the total solids of the lymph, collected over ten-minute periods, were made in 6 experiments. The samples were dried on the water bath and then heated in the oven at 105° C. until the weight was constant. Blood pressures were recorded graphically with a mercury manometer in the usual way. Blood samples (about 5 cubic centimeters) were collected in test tubes from the femoral artery, a clean, dry, glass cannula being employed each time. Sufficient blood to wash out the cannula was allowed to pass through before the sample (in duplicate) was taken. The blood was considered to have clotted when the tubes could be reversed without spilling.

The results of two of the experiments in which the total solids of the lymph were determined are given in Tables I and II. These experiments show an increased flow of lymph of almost three times the normal. This lymph is richer in solids than the samples collected before the injection. Blood pressure underwent the typical fall to be expected from lymphagocic substances. The clotting time of the blood is slightly extended in experiment 10 (Table I), but is shortened in experiment 11 (Table II). We have observed this unexpected result in several of our experiments. Every sample of lymph which we collected promptly clotted.⁴

That the mango juice may produce the typical inhibition of

² *Skandin. Arch. f. Physiol.* (1900), 10, 403.

³ *Am. Journ. Physiol.* (1902), 7, 380.

⁴ Experiments have been reported in dogs with thoracic fistula in which the clotting time of the blood was only slightly, if at all, affected by proteose injections, while the coagulability of the lymph was delayed. Spiro and Ellinger, *Zeitschr. f. physiol. Chem.* (1897), 23, 135; Chittenden, Mendel, and Henderson, *Am. Journ. Physiol.* (1889), 2, 142.

blood clotting is shown in the following experiment in which no thoracic fistula was made:

Experiment 11, June 25, 1914.—Male dog, weighing 5.8 kilograms. Normal blood obtained at 9.40 a. m. clots in fifteen minutes. At 9.45 a. m. the dog received a rapid injection of 40 cubic centimeters of fresh mango juice. Blood pressure fell immediately from 178 to 45 millimeters. Blood samples obtained five, ten, and thirty minutes after injection failed to clot in twenty-four hours.

That a certain degree of tolerance or immunity results from consecutive injections, both for lymph flow and blood pressure, is shown in experiment 12 (Table III). In this experiment only from 17 to 20 cubic centimeters of the juice were given at a single injection, as the dogs do not withstand very well the repeated administration of larger amounts. In the latter case, the second injection may be nearly as efficient as the first, as shown in experiment 8 (Table IV).

Clopatt has shown that the quantities of sugar and salts, in the berry extracts employed, were too small to ascribe the marked results obtained to a lymphagogic effect of the second class (Heidenhain). Mendel and Hooker calculated that the maximum amount of sugar used in the largest injection of strawberry extract would not exceed 0.2 gram per kilogram of body weight of the dog used. The mango pulp has the following composition:

*Composition of mango pulp.*⁵

	Per cent.
Water	82.8
Solids	17.2
Sugar (as invert sugar)	13.24
Acid (as citric acid)	0.18
Protein	0.22
Crude fiber	2.6
Ash	0.45

The sugar given in experiment 10 (Table I) amounts then to only about 0.3 gram per kilogram of body weight. Furthermore, the increase in total solids of the lymph collected after the injection of the mango juice is characteristic of the first and not of the second class, or crystalline, lymphagogues. With the second class, in fact, there is usually a diminution of the total solids. The additional evidence of the constant fall in blood pressure, the observation that the mango juice may produce

⁵ Pratt and del Rosario, *This Journal*, Sec. A (1913), 8, 59.

the characteristic inhibition of the clotting powers of the blood, and the diminished response to consecutive injections indicate that the effects of the mango are similar to those of lymphagogues of the first class.

TABLE I.—*Experiment 10, June 14, 1914. Male dog, weighing 11.9 kilograms.*

Time.	Lymph in 10 minutes.	Total solids.	Blood pressure.	Blood clots.	Remarks.
	<i>cc.</i>	<i>Per cent.</i>	<i>mm.</i>	<i>Min.</i>	
10.17-10.27 a. m.	4.5	6.3			The lymph clots.
10.23 a. m.				11	
10.51 a. m.			120		Injection of 25 cc. of fresh mango juice.
10.52 a. m.			76		
10.52-11.02 a. m.	12.5	7.8			The lymph clots.
10.54 a. m.				11.5	
10.58 a. m.				12.0	
11.05 a. m.				15.0	
11.12-11.22 a. m.	5.0	6.6			Do.
11.21 a. m.			110		
12.01-12.11 p. m.	4.5	6.3			Do.
12.12 p. m.			116		

TABLE II.—*Experiment 14, July 3, 1914. Female dog, weighing 6.6 kilograms.*

Time.	Lymph in 10 minutes.	Total solids.	Blood pressure.	Blood clots.	Remarks.
	<i>cc.</i>	<i>Per cent.</i>	<i>mm.</i>	<i>Min.</i>	
10.51-11.01 a. m.	5.5	5.0			The lymph clots.
10.59 a. m.				14	
11.15 a. m.			140		Injection of 40 cc. of fresh mango juice.
11.16-11.26 a. m.	16.0	5.7			The lymph clots.
11.17 a. m.			66		
11.20 a. m.				6	
11.27-11.37 a. m.	18.0	5.3			Do.
11.30 a. m.			134	9	
11.40 a. m.				7	
11.40-11.50 a. m.	11.0	5.1			Do.
11.50 a. m.-12 m.	8.5	4.3			Do.
12 m.				13	

TABLE III.—*Experiment 12, June 4, 1914. Male dog, weighing 9.4 kilograms.*

Time.	Lymph in 10 minutes.	Blood pressure.	Blood clots.	Remarks.
	cc.	mm.	Min.	
10.14-10.24 a. m.-----	3			The lymph clots.
10.22 a. m.-----			15	
10.39 a. m.-----			13	
10.39-10.49 a. m.-----	3			Do.
10.51 a. m.-----		154		
10.52 a. m.-----				Injection of 17 cc. of fresh mango juice.
10.52-10.52.45 a. m.-----		98		
10.53-10.53.30 a. m.-----		134		There seems no explanation for this transient rise in blood pressure.
10.54-11.04 a. m.-----	8			The lymph clots.
10.56 a. m.-----		68		
10.57 a. m.-----			8.5	
11.00 a. m.-----		120		
11.06 a. m.-----		146		
11.07-11.17 a. m.-----	6			Do.
11.18 a. m.-----			11	
11.19 a. m.-----		145		
11.19.30 a. m.-----				Injection of 17 cc. of fresh mango juice.
11.20.30-11.30.30 a. m.-----	4.5	80		The lymph clots.
11.21.30 a. m.-----		104		
11.22 a. m.-----			10	
11.27 a. m.-----		122		
11.32.30 a. m.-----		145		Injection of 20 cc. of fresh mango juice.
11.33 a. m.-----		82		
11.34-11.44 a. m.-----	4			The lymph clots.
11.35 a. m.-----		99		
11.35.30 a. m.-----			8.5	
11.45.30 a. m.-----		150		
11.46 a. m.-----				Injection of 20 cc. of fresh mango juice.
11.46.30 a. m.-----		90		
11.47 a. m.-----		114		

TABLE IV.—*Experiment 8, May 5, 1914. Male dog, weighing 9.5 kilograms.*

Time.	Lymph in 10 minutes.	Blood pressure.	Blood clots.	Remarks.
	cc.	mm.	Min.	
11.15-11.25 a. m. -----	5			The lymph clots.
11.20 a. m. -----			10	
11.31-11.41 a. m. -----	5.5			Do.
11.32 a. m. -----			14	
11.55 a. m. -----		161		Injection of 25 cc. of fresh mango juice.
11.56 a. m. -----		74		
11.56 a. m.-12.06 p. m. -----	12			The lymph clots.
12.57 p. m. -----			17.5	
12.03 p. m. -----			15	
12.07-12.17 p. m. -----	13			Do.
12.12 p. m. -----			12	
12.18-12.28 p. m. -----	8			Do.
12.23 p. m. -----		124		
12.31 p. m. -----		136		Injection of 25 cc. of fresh mango juice.
12.32 p. m. -----		64		
12.32-12.47 p. m. -----	11.5			The lymph clots.
12.34 p. m. -----			10	
12.39 p. m. -----		70	10	Blood pressure remained low and the dog was killed.

OBSERVATIONS ON MANGO RASH

By ISABELO CONCEPCIÓN

(From the Department of Physiology, College of Medicine and Surgery,
University of the Philippines)

INTRODUCTION

It is a common belief among the people of the Philippine Islands that the transient rashes of erythematous type occurring during the hot season are caused by the eating of mangos (*Mangifera indica* L.). However, there is no definite evidence to indicate that the mango is the causative agent. It has long been recognized that strawberries, crustaceans, and oysters are the etiologic factors in certain urticarias and other rashes, local œdemas, etc. These substances seem even to be able to exercise an influence on the nursing baby through the milk of the mother.¹

The object of the present study is to find out whether the mango in the Philippines is really a responsible factor for some of these transient rashes occurring so commonly from April to July. At the same time observations were made to ascertain if this fruit has any influence on the nursing baby through the milk of the mother.

Four newly delivered nursing mothers in the obstetrical ward of the Philippine General Hospital were chosen and were fed usually six mangos daily with their meals. Careful attention was given to select patients who were free from skin rashes. Daily observations were made on both mother and baby, particularly as to the development and disappearance of rashes; subjective symptoms were noted carefully. Purgatives were given, when necessary, to eliminate intestinal auto-intoxication as far as possible. It may be stated that both mother and baby were sleeping under mosquito nets so that mosquito bites were practically excluded.

¹ Firmin observed urticaria in an infant whose nursing mother had partaken of oysters and fish. Cited from Pfaundler and Schlossman, Diseases of Children, translated by H. L. N. Shaw and L. La Fetra. J. B. Lippincott Company, New York (1908), 4, 443.

CASE I

N. C., Filipino woman, 24 years old, married to an American. She was admitted to the hospital on June 6, 1914, and delivered on the same day. Family history is negative. Previous history is unimportant, except that she states that she is prone to have a rash after eating several mangos. The patient is fairly well developed and well nourished, and shows no signs of dyspnoea or discomfort. Examination of the systems is negative.

The baby (female) was normally delivered, and is fairly well developed. This is the fourth child. Subjective examination of the systems is negative. The skin is light colored.

June 6. Four mangos only were given this day.

June 7. Examination of the mother showed a few papulomacular areas with some vesicles. These are of a uniform size, about that of a pinhead or a little larger, and are purplish red. These eruptions are located on the interscapular region, and itch considerably. Temperature is normal. She is constipated.

Examination of the baby is negative.

June 8. The mother has developed more areas of the same kind on her back. She complains of marked itching. She is constipated.

The baby is apparently normal.

June 9. Some vesicular eruptions of about a pinhead in size have appeared on both sides of the neck of the mother. She complains of marked itching. She was given a cathartic this morning, and had four bowel movements.

The baby shows a few maculopapular eruptions on the cheeks. These are about 1 millimeter in diameter.

June 10. The mother has developed numerous papular vesicles on her chest and neck and a few on the extensor surfaces of both arms. The temperature is normal. She has had 6 bowel movements.

The eruptions on the baby's face have disappeared, but she has developed a few vesiculopapular areas on the neck. In the afternoon of the same day the rash had appeared abundantly on the neck and to a slight extent on the back. The baby is otherwise comfortable. No subjective symptoms of any kind were noted.

June 11. Examination of the mother shows an extensive acute vesiculopapular rash on her chest, back, and neck. Her bowels are normal. Temperature is normal. She complains of marked itching.

The baby has developed a few eruptions on the extensor surfaces of the lower extremities. Those on the neck and back are still present.

June 12. In the mother, the rash is not so acute as on the previous day. Itching is very much diminished.

The baby still shows a few areas on the neck, but those found on the extremities have almost disappeared.

June 13. The mango feeding was discontinued. Calomel and saline purgative were given to the mother, and she had two bowel movements. She no longer complains of itching. Both mother and baby look very much as on the previous day.

June 15. The eruptions on the chest and back of the mother are very much diminished, and the vesicles are in a drying condition.

The baby has developed a few more papulovesicular eruptions on the neck. Those found on other parts of the skin have disappeared.

June 16. The rash still persists to a slight degree in both mother and baby. They were discharged from the hospital subsequent to the examination.

CASE II

J. L., Filipino woman, 27 years old, married. She was admitted to the hospital on June 20, 1914, and delivered on the next day. Family history and previous diseases are negative. The patient is fairly well developed, pale, and lying flat on bed without any sign of dyspnoea or discomfort. Examination of the systems is negative.

The baby (male) was prematurely born and is small. The skin is dry; the subcutaneous tissue is very loose.

Mango feeding was begun June 21. The mother was given 6 mangos for five days, 5 mangos for a day, and then 8 mangos for a day. She was observed twice a day during the period of the experiment. After eight days of feeding she failed to develop a rash.

On the eighth day, the baby had a few papulovesicular eruptions on the face which lasted for two days.

The mother and child were discharged on June 29.

CASE III

A. P., Syrian woman, 26 years old, married. She was admitted to the hospital on June 20, 1914, and delivered of a female child on the next day. Family history and history of previous diseases are negative. Examination shows some papules on the mammary regions in drying condition.

June 21. Mango feeding was begun.

June 22. The mother complains only that her bowels are constipated. There is no rash either on the mother or baby.

June 23. The mother complains of marked itching of the skin of the chest and in the axillary regions. On examination, there are many papules and papulovesicles in acute condition on the above-mentioned places.

The baby has developed a few papulovesicles on the face.

June 24. The mother complains less of itching. The eruptions found yesterday are very much diminished in extent.

The previous rash of the baby is much increased. She has also developed some new areas on the extensor surfaces of her legs and thighs.

June 25. Mango feeding was discontinued. The mother does not complain of itching. Eruptions on her body have disappeared.

Examination of the baby shows that of the papules of the previous day only very slight traces are left on the face.

June 26. The mother still has some traces of the rash; otherwise she is comfortable.

The baby is almost the same as on the previous day.

June 27. The mother is clear from the rash of the previous days.

The baby is apparently normal.

June 28. Mother and baby are apparently normal.

June 29. The mango feeding was resumed. The mother and baby are negative.

June 30. The mother and the baby are apparently normal.

July 1. The mother is negative.

The baby has developed a few papules with some papulovesicles on the face and also on the extensor surfaces of the arms.

July 2. The mother is normal.

The baby has a few eruptions on the arms, although these are not so severe as on the previous day. The baby and the mother were discharged from the hospital after the examination.

CASE IV

P. C., Filipino woman, 20 years old, married. She was admitted to the hospital on June 20, 1914, and delivered on the next day. Family history and history of previous diseases are negative. The patient is fairly well developed, and is well nourished. She has apparently no signs of dyspnoea nor discomfort, but is not able to be about. Examination of the systems is negative.

The baby (male) was normally delivered, and is fairly well developed. Examination of the systems is negative.

June 21 Mango feeding was begun.

June 22. The mother has developed a few maculopapules on her right arm. No itching nor burning sensation is felt. The bowels are constipated.

The baby is apparently normal.

June 23. The mother complains of marked itching. She has developed many small papules and vesicles on the neck and breasts. She was given a saline purgative, and had seven movements during the day.

The baby is normal.

June 24. Examination of the mother shows that the eruptions of the mammary region have almost disappeared, but she has developed a few of the same kind on her back. She still complains of marked itching.

The baby shows some papulovesicular rash on the face and neck.

June 25. Mango feeding was discontinued. The mother does not complain of itching. The vesicles on her chest are in a drying condition.

The baby still shows a few areas on the face.

June 26. The mother is almost free from rash. Itching has discontinued. Examination of the baby is negative.

June 27. Mango feeding was resumed.

June 28. The mother again complains of slight itching. On examination it was found that she has developed a few eruptions of papulovesicular character on the neck, shoulder, and infraclavicular regions.

The baby has also developed a few papulovesicles on the neck.

June 29. The mother shows some erythema on the neck and back. The itching has discontinued.

The baby still has a few papulovesicles on the face.

The mother and child were discharged from the hospital subsequent to the examination.

DISCUSSION AND CONCLUSION

The frequent occurrence of these rashes in a certain season of the year, generally from April to July, coincident with the hot season, leads us to a suspicion that these rashes are nothing more than the ordinary *miliaria rubra* frequently observed at this time. But when it is considered that these rashes were developed even during the cool typhoon periods and that they may be

made to appear and disappear by discontinuing and renewing the mango feeding, it can be concluded that the etiology of these rashes is to be ascribed to the fruit itself.

The rash observed on the mother after mango eating is of the papulovesicular type with small papules and vesicles. These are characterized by more or less persistence of the lesions, marked itching, and absence of other subjective symptoms. The size of the papules and vesicles varies from that of a pinhead to about 2 millimeters in diameter. They are round or sometimes oval in shape, and appear in patches. The rash must be classed as an erythema and not as urticaria. The commonest places for the rash to develop are on the mammary regions, the neck, and the extensor surfaces of the upper extremities. The eruptions found on the baby are generally of the maculopapular type. In some instances, the papulovesicular type can also be found. They appear usually either singly or in patches. Their shape is circular, and they are comparatively larger than those found on the mother. The lesions are also less persistent, as compared to those in the mother, and are less irritating. They generally develop on the face, the neck, and the extensor surfaces of the extremities and not infrequently on the back.

Other points of interest in connection with these observations may be mentioned. In all of the above cases, except one (case II), rashes were produced in both mother and child; this exception indicates that individual susceptibility is a factor in the development of the rash. After successive days of feeding, the mother may acquire some degree of immunity or tolerance, as shown by case III, in which renewal of the mango feeding failed to produce a second rash. The rashes have appeared on the babies whenever mangos were given to the mothers. The babies, therefore, seem to be more susceptible than are the adults.

In conclusion, I wish to express my thanks to Prof. R. B. Gibson for his suggestions and help in carrying out these observations. My thanks are also due to Dr. M. Tolentino, of the department of obstetrics of the Philippine General Hospital, who secured the patients for the experiments.

MILK POISONING DUE TO A TYPE OF STAPHYLOCOCCUS ALBUS OCCURRING IN THE UDDER OF A HEALTHY COW¹

By M. A. BARBER

(*From the Biological Laboratory, Bureau of Science, Manila, P. I.*)

During the years 1909–1913 cases of acute gastroenteritis occurred repeatedly on a certain farm in Nueva Ecija Province, Luzon, P. I. The symptoms resembled those of so-called ptomaine poisoning. Vomiting and diarrhœa were constant symptoms, sometimes accompanied by muscular cramps and faintness. Patients were usually well enough to be about within a few hours, although weakness and malaise often persisted a day or so.

Occasional cases occurred among the American residents of the farm and among the Filipino employees, but more often visitors were attacked. The origin of the trouble could not be found in any kind of food, since this was carefully prepared, and consisted of the articles ordinarily used in other households where no trouble occurred. Fresh milk and cream, obtained from two cows kept on the farm, were in daily use, but these were not suspected, since they were freely used by the children of the family, and supplied to the family of a neighbor, none of whom had any trouble. The water of the well was suspected, but chemical and bacteriological analyses, and tests made by drinking quantities of samples sent to the laboratory of the Bureau of Science, gave wholly negative results.

The cases showed a curious seasonal incidence, occurring almost wholly during the hot dry season of the year—March, April, May, and June—and never, or rarely, during the rainy or the cool dry season. Few or no cases occurred during the year 1911.

I made several visits of investigation to the farm, and was three times the victim of attacks there. No member of the family showed any symptoms at the time of these attacks, or at most very slight ones, although on two occasions the same articles of food and drink were served to all. On one visit, I drank the

¹ Read before the Far Eastern Medical Association, December, 1913.

fresh milk of both cows with no bad results. It was noted, however, that all of these attacks followed the ingestion of fresh, sweet cream, after an interval of one and three-fourths to two and a half hours. So milk was drawn directly into cleaned bottles, and brought to the laboratory, keeping it in contact with ice or in a refrigerator. The milk of the two cows was kept separate. Something over twenty-four hours after the milk had been drawn, I took a dose of 30 cubic centimeters of the cream of one of the cows. This sample had not been above refrigerator temperature. No symptoms followed. The bottle from which the sample was taken was then left at a room temperature of 28-30° C. for five hours, and a second dose of 40 cubic centimeters of mixed milk and cream was taken. About one and three-fourths hours afterwards, a decided nausea and diarrhoea set in, which lasted several hours. Symptoms were similar to those experienced before, but much milder, and recovery was complete within a few hours. For confirmation, several volunteers took doses of the cream of both cows. No symptoms followed the use of the milk and cream from one cow, but three persons who took cream from the one tested by me showed decided symptoms; in one case, that of a person who took 50 cubic centimeters, the attack was violent, and the illness lasted about two days.

Agar cultures made from milk, drawn with all precautions into sterile test tubes, gave micrococci in both cows. In the suspected cow, these were of two sorts. A yellow staphylococcus from a quarter of the udder which, three years previously, had been the seat of an attack of garget, and a white staphylococcus occurring abundantly in practically pure culture in milk from the other quarters. The other cow gave practically a pure culture of a yellow staphylococcus differing in color and consistency of colonies from the yellow staphylococcus of the suspected cow.

Transfers were made from pure cultures of both the yellow and the white staphylococci from the suspected cow into flasks containing preserved milk from Norway. Both flasks were incubated at 36°.5 C. for about eight and a half hours. A control flask from the same tin, also incubated, was proved by plate cultures to be sterile. A dose of 50 cubic centimeters of the milk inoculated with the yellow staphylococcus was taken by me and gave no symptoms. A similar dose of 50 cubic centimeters from the flask inoculated with the white staphylococcus was taken the next day—the flask having remained in the refrigerator after removal from the incubator. In one and three-fourths

hours an attack of gastroenteritis followed, similar in all details to the ones experienced on the farm, but somewhat more violent than any of them. The cramps and faintness, especially, were pronounced. The more violent symptoms disappeared within seven or eight hours, although slight cramps persisted much longer. The next day there remained only malaise and a slight digestive disturbance.

The evidence, then, is conclusive that the illness is due to a poison formed by the white staphylococcus in milk. The yellow staphylococcus, apparently, is unable to produce this toxin.

The white and the yellow staphylococci from the suspected cow were compared on various media, including some 12 different litmus agars. The cocci of the white form are somewhat smaller than those of the other, and show a greater tendency to form diplococci. Cultures further differ in that the white strain formed acid on mannite and maltose litmus agars, while the yellow did not. Both ferment lactose, but the white in a less degree than the yellow. Agglutination tests were made with my serum after 5 attacks of the illness and within one month after the last attack. The yellow form gave complete agglutination in dilutions from $\frac{1}{50}$ up to $\frac{1}{80}$, differing in various tests, while the white never gave it in dilutions higher than $\frac{1}{40}$. In a test with the serum of a resident of the farm, who was tolerant of the poison, the white form failed to give complete agglutination in a dilution higher than $\frac{1}{40}$.

Inoculated subcutaneously into guinea pigs and monkeys, the white form gave decidedly more reaction than the yellow—in some cases abscesses were formed by it, which later healed. Rabbits have resisted doses of the white variety up to 0.3 cubic centimeter of an 18-hour broth culture, given intravenously. Kittens, pups, and monkeys show no symptoms on ingesting large quantities of milk cultures of the white staphylococcus; or, at all events, the symptoms are very slight. A goat fed with 3 slants of the culture showed no cocci in the milk.

The cow from which the toxin-producing staphylococcus was obtained is of mixed breed. She was imported from Australia, and came into the possession of the present owner in 1909. She has been immunized to Texas fever and has had rinderpest and foot and mouth disease, all previous to 1909. In 1910 she had garget in one quarter of the udder, but has been apparently healthy since. It is noteworthy that the quarter which suffered from garget has shown few or none of the toxin-producing staphylococci, while this organism occurred in nearly pure culture

in the other three quarters. Since several cases of the poisoning were noted previous to the occurrence of garget in the cow, this could not have been the origin of the trouble. A young cow, the offspring of the infected one, has been in contact with the mother about two years, and gives apparently wholesome milk.

Staphylococci are commonly found in the milk of apparently healthy cows, but I have been unable to find in the literature any reference to the formation by a staphylococcus of a toxin producing the symptoms above described. The staphylococcus isolated in this case may be an unusual strain; or, it is possible that it is not uncommon, but that the usual practice of keeping milk refrigerated prevents the formation of the toxin. Ice was not in daily use on this farm, and as stated above cream from the infected cow which had been kept cold for twenty-four hours did not give the symptoms, but these followed the ingestion of cream from the same bottle after it had been left five hours at room temperature. As noted above, the cases of gastroenteritis occurred chiefly during the hot months of the year. This was the season when the milk from the infected cow was mostly used, but the attacks at this season may have been due in part to the higher temperature which favored the growth of the staphylococcus. There was nothing unusual in the taste of the infected cream.

Since the cause of the poisoning became known, the use of the raw milk of the infected cow has been discontinued, and all trouble has ceased. One person during a residence of several months on the farm had suffered from indigestion of a chronic character, but had had few acute attacks. With the discontinuance of the use of infected milk his indigestion ceased.

As has been stated, milk from the two cows was regularly furnished to a neighbor, and no attacks occurred in his family. His freedom from the trouble is probably due to the fact that the milk was commonly used fresh in his household. In the cases of the family of the owner of the cow, some resistance to the toxin had apparently been developed. On two occasions at least when I suffered attacks at the farm, the infected cream was eaten by members of the family who subsequently showed no decided symptoms. A sample of the cream which had caused a severe attack in me was preserved, and the next day a member of the family took a large dose of it. Only slight symptoms followed. The cream had become sour in the meantime. The evidence that all members of the family had acquired some tolerance to the toxin seems conclusive.

In summary, the most noteworthy points of this paper are the following:

Acute attacks of gastroenteritis were produced in milk by a toxin elaborated by a white staphylococcus which occurred in almost pure culture in the udder of a cow. The fresh milk was harmless, and the toxin was produced in effective quantities only after the milk had stood some hours at room temperature.

Repeated attacks of the illness had occurred among residents and visitors at the farm during a period of three years, and the cow was apparently in good health during this time, except for one attack of garget, which occurred after the cases of gastroenteritis had begun.

Persons who had used the milk continuously had apparently developed some tolerance to the toxin. Two children of the family had used the milk regularly, but never had attacks. The adults had occasional light attacks or, in one or two cases, some chronic intestinal trouble. In my own case, 4 acute attacks, 3 of them severe, afforded no protection against a subsequent fifth dose. Visitors at the farm and Filipino employees who used the milk less regularly showed most severe attacks. Since the discontinuance of the use of raw milk from this cow, all trouble has ceased.

Culturally, the toxin-producing staphylococcus differed little from a nontoxin-producing strain, except that the former produced acid in mannite and maltose litmus agars.

Agglutination tests with the serum of a person who had recently suffered 5 attacks and that of a person who had long used the milk showed little, if any, positive result.

In guinea pigs and monkeys the toxin-producing strain showed more tendency to form abscesses than a yellow staphylococcus from the same source.

Cases of gastroenteritis occurring in the tropics and in the warm season elsewhere may be due to a toxin of similar origin, especially where fresh milk is not properly refrigerated before use. This is the more probable since staphylococci of various types commonly occur in the udders of apparently healthy cows.

ADDENDUM.—The cow which harbored the toxin-producing *Staphylococcus* was sold to the College of Agriculture at Muñoz, Nueva Ecija. A letter from the superintendent of the school, Mr. Kilmer O. Moe, dated January 6, 1915, states that the milk of the cow is being used by the students at present. However, it is used fresh and principally in coffee; no bad results have followed its use.

REVIEWS

Morris's | Human Anatomy | a complete systematic treatise | by English and American authors | edited by | C. M. Jackson, M. S., M. D. | professor and director of the department of anatomy, | University of Minnesota | eleven hundred and eighty two illustrations | three hundred and fifty eight printed in colours | fifth edition, | revised and largely rewritten | Philadelphia | P. Blakiston's Son & Co. | 1012 Walnut Street | No date; copyright, 1914. Cloth, pp. i-xiv+1-1539. Price, \$6.

This book represents the combined efforts of twelve of the most prominent American and English anatomists, who have succeeded well in their attempt to revise and revive a textbook in anatomy which was rapidly falling into disuse. The editor has put forth special effort to discriminate systematically between fundamental and detailed anatomical facts. To meet these conditions, the book is printed in a large and small type; the former is used to indicate the fundamental facts, the latter, the details of anatomy. This arrangement should meet the approval of the student.

As previously indicated, the book contains a large number of illustrations, almost one-third of them in colors. It appears as though special emphasis and stress has been placed on quantity rather than quality, as some of the prints are very indistinct and of little value to the student. Some of the prints are new, but most of them are taken from previous editions and other textbooks.

The Anglicized form of the BNA is used with a few exceptions where the original BNA or the Latin form is adopted in the English. Since the general adoption of the BNA, anatomical terms have been reduced from 30,000 to 5,000. It seems obvious, therefore, that with the large reduction in the number of terms the student could and should master the Latin anatomical terminology adopted by the International Congress at Basel. While the Anglicized form, in most cases, differs but little as a whole from the original BNA, yet in some instances the terms are vastly different, and scarcely recognized by the student.

The last section on clinical and topographical anatomy could well have been omitted, as they are rarely if ever referred to in the study of systematic anatomy.

Both clinical and topographical anatomy should be taught as individual courses, and the section dealing with them is entirely too inadequate for a student's guide.

As a whole the book is reliable throughout and can be safely recommended as one of the standard textbooks in anatomy.

E. S. RUTH.

The Diagnosis and Treatment | of | Tropical Diseases | by | E. R. Stitt, A. B.,
Ph. D., M. D. | medical director, U. S. Navy; [etc., 8 lines] | with
86 illustrations | Philadelphia | P. Blakiston's Son & Co. | 1012
Walnut Street | No date; copyright, 1914. Cloth, round corners, pp.
i-xi+1-421. Price, \$2.

This little volume should commend itself to medical men generally as a clear and concise exposition of what is known of tropical diseases. Despite numerous typographical errors the book can be heartily commended.

J. A. J.

INDEX

A

- ACOSTA-SISON, HONORIA, Pelvimetry and cephalometry among Filipinas, 493.
- Amœbic and bacillary dysenteries in the Philippine Islands, data on, 205.
- Anopheles albimanus, 427.
- barbirostris van de Wulp, 384, 389.
- (Celia) albimanus, 434.
- culicifacies, 387.
- febrifer Banks, 384.
- fuliginosus, 391.
- funesta, 384.
- jesoensis Tsuzuki, 389.
- karwari, 390, 391.
- larvæ in captivity, development of, 421.
- ludlowii Theobald, 384, 385.
- maculata Theobald, 390.
- maculatus Theobald, 384, 390.
- malefactor, nontransmission of malaria by, 381.
- (Myzomyia) febrifer sp. nov., the transmission of malaria with, 381 et seq.
- (Myzorhynchus) barbirostris, the transmission of malaria with, 381 et seq.
- sinensis, the transmission of malaria with, 381 et seq.
- (Nyssorhynchus) fuliginosus Giles, 391.
- maculatus, the transmission of malaria with, 381 et seq.
- (Pseudomyzomyia) rossii, the transmission of malaria with, 381 et seq.
- pseudopunctipennis, 427.
- rossii Giles, 384, 385.
- sinensis Wiedemann, 384, 389.
- (jesoensis), 390.
- vagus Dönitz, 385.
- "Anopheles I," 387.
- "Anopheles Ia," 391.
- "Anopheles II," 389.
- Anophelines, avidity of, for human blood, 424.
- Anthrax bacillus, 466 et seq.
- Ants as carriers of Asiatic cholera, cockroaches and, 1.
- Apparatus, some simple laboratory, 297.
- venous-pressure, 297.

- Ascaris, 81, 83, 173, 234 et seq., 446 et seq.
- Asiatic cholera, notes on the diagnosis of, 361.
- Aurellia labiata Cham. and Eysen., 294.
- Autopsies, the chief intestinal lesions in one thousand, 453.

B

- Bacillary and amœbic dysenteries in the Philippine Islands, data on, 205.
- colitis, 453, 457 et seq.
- dysentery: The most prevalent form in Manila and its treatment, 241.
- Bacillus coli, 244.
- dysenteriae, 242 et seq.
- lepræ, 227, 230.
- pyocyaneus, 347.
- "S," 244 et seq.
- tuberculosis, 333, 340.
- typhosus, 253 et seq.
- Bacillus of anthrax, 466 et seq.
- diphtheria, 466 et seq.
- glanders, 466 et seq.
- plague, 466 et seq.
- Bacterium coli, 320, 340.
- commune, 326, 329.
- Balantidium, 81, 83, 173, 446 et seq.
- coli, 87, 173.
- BANKS, CHARLES S., Sanitary survey in Mindoro. 5. The mosquito survey in and near San Jose, 163.
- BARBER, M. A., Cockroaches and ants as carriers of the vibrios of Asiatic cholera, 1; The pipette method in the isolation of single microorganisms and in the inoculation of substances into living cells, 307; review of Manson's Tropical Diseases, a Manual of the Diseases of Warm Climates, 463; review of Henson's Malaria Etiology, Pathology, Diagnosis, Prophylaxis, and Treatment, 463; Milk poisoning due to a type of Staphylococcus albus occurring in the udder of a healthy cow, 515; *see also* WALKER, ERNEST LINWOOD, 381.
- Beriberi, in the Philippine Islands, 203.
- rice in relation to, 119.
- Book reviews, *see* Reviews (book).
- BOYNTON, WILLIAM HUTCHINS, A preliminary report of experiments on the cultivation of the virus of rinderpest in vitro, 39; An atypical case of rinderpest in a carabao, 45; Experiments on the cultivation of rinderpest virus as described by Baldrey, 259; Kidney-worm infestation of swine in the Philippine Islands with special reference to the pathological changes, 269; *see also* WARD, ARCHIBALD R., 49.

C

- CALDERON, FERNANDO, Some data concerning the medical geography of the Philippines, 199.
- Carabao, an atypical case of rinderpest in a, 45.
- Carabaos, simultaneous method of inoculating, 125.
- Carus, Paul, *see* Reviews (book).
- Catostylus purpurus Mayer, 293, 294.
- Cats, plague in, 10.
- Cattle and carabaos, simultaneous method of inoculating, 125.
- Celia kochi Dönitz, 384.
- Cephalometry, among Filipinas, 493.
- Cestode, 81, 83.
- Chemiotaxis, experiments on, 341.
- Chiropsalmus quadrigatus Haeckel, 291, 293.
- Cholangitis, 459.
- Cholera, Asiatic, at autopsy, 453.
 - cockroaches and ants as carriers of, 1.
 - notes on the diagnosis of, 361.
 - spirillum, 466 et seq.
 - vibrio in Manila waters, vitality of the, 479.
 - vibrios, longevity of, 3.
- "Chrysaora state," 292.
- Clonorchis, 236, 240.
- Cockroaches and ants as carriers of Asiatic cholera, 1.
- Colitis, 459.
- CONCEPCION, ISABELO, Observations on mango rash, 509; *see also* GIBSON, R. B., 119; 503; *see also* WALKER, E. L., 167.
- Corynebacterium, 220, 222, 224.
- Councilman, W. T., *see* Reviews (book).
- COX, C. E., review of Reed's Marriage and Genetics, Laws of Human Breeding and Applied Eugenics, 463.
- COX, SETH L., *see* MUSGRAVE, W. E., 173; *see* WALKER, E. L., 181.
- Cropper, J. W., *see* Ross, H. C.
- CROWELL, B. C., review of Dorland's The American Illustrated Medical Dictionary, 304; Notes on the diagnosis of Asiatic cholera at autopsy, 361; review of Vedder's Beriberi, 380; The chief intestinal lesions encountered in one thousand consecutive autopsies in Manila, 453; review of Lee's Microtomists' Vade-mecum, 461; review of Councilman's Disease and Its Causes, 452; review of Lewis's A Text-book of Histology Arranged upon an Embryological Basis, 462.
- Culex fatigans, 483.
- ludlowii, 164.

D

- Dactylometra quinquecirrha L. Agassiz, 292 et seq.
- DALBURG, F. A., Sanitary survey of Mindoro. 2. Geography and geology, 142.
- De la Mettrie, Julien Offray, *see* Reviews (book).

Dibothriocephalus, 178.

latus, 173.

- Diphtheria bacillus, 466 et seq.
- Dissection, technique for, 307.
- Dorland, W. A. Newman, *see* Reviews (book).
- DUMEZ, A. G., review of Pittenger's Biochemic Drug Assay Methods, with Special Reference to the Pharmacodynamic Standardization of Drugs, 379.
- Duodenal ulcer, 453, 458.
- Dysenteries, amebic and bacillary, in the Philippine Islands, data on, 205.
- Dysentery, bacillary, the most prevalent form in Manila and its treatment, 241.

E

- Emetine, treatment of entamoebiasis with, ipecac, and neosalvarsan, 93.
- Entamoeba, 173, 446.
 - coli, 81 et seq., 93 et seq.
 - histolytica, 81 et seq., 93 et seq.
- "Entamoeba tetragena," 97.
- Entamoebiasis, in patients of the Philippine General Hospital, Manila, P. I., 81; preliminary report on the treatment of, with ipecac, emetine, and neosalvarsan at the Philippine General Hospital, Manila, P. I., 93.
- Entamoebic colitis, 453, 455 et seq.
- Enteritis, 459.
- Enterocolitis, 459.

F

- Filaria hancrofti Cobbold, 483, 488 et seq.
 - demarquayi, 488 et seq.
 - magalhaesi, 488 et seq.
 - nocturna, 202.
 - ozzardi, 488 et seq.
 - perstans, 488 et seq.
 - philippinensis, 483.
 - (Loa) loa, 488 et seq.
 - found in the Philippine Islands, 205, 483.
- Filipinas, pelvimetry and cephalometry among, 493.
- Fleas in relation to plague, 12.

G

- Geography, of the San Jose Estate, 142.
 - medical, of the P. I., 199.
- Geology of the San Jose Estate, 142.
- Germicidal power of glycerin on various microorganisms under various conditions, 465.
- GIBSON, R. B., Some simple laboratory apparatus, 297; review of de la Mettrie's Man a Machine, 304; review of Howell's A Text-book of Physiology for Medical Students and Physicians, 461; A note on the physiological action of the proteoses, 499.
- GIBSON, R. B., and CONCEPCION, ISABELO, Nerve degeneration in fowls fed on unhusked rice (palay), 119; The lymphagogic action of the Philippine mango, Mangifera indica Linnæus, 503.
- Glanders bacillus, 466 et seq.

Glossina morsitans, 332.
 Glycerin, germicidal power of, on various microorganisms, 465.
 GUTIERREZ, PERPETUO, Typhoid fever in the Philippines, 367; *see also* WILLETS, DAVID G., 93; *see also* MUSGRAVE, W. E., 173.
 GUZMAN, A. M., *see* WALKER, E. L., 167.

H

HEISER, VICTOR G., Reappearance of plague in the Philippines after an absence of six years, 5.
 Helminthiasis, intestinal, in the Philippine Islands as indicated by examinations of prisoners upon admission to Bilibid Prison, Manila, P. I., 233.
 Henson, Graham E., *see* Reviews (book).
 Hering, Ewald, *see* Reviews (book).
 Hookworm, 81, 83, 173, 179, 236, 446.
 Howell, William H., *see* Reviews (book).
 Hymenolepis nana, 236.

I

Infection, genitourinary, 459.
 Inoculation, simultaneous method of, of cattle and carabaos with serum from animals that have been recently immunized, 125.
 Insects as carriers of Asiatic cholera, 1.
 Intestinal helminthiasis in the Philippine Islands as indicated by examinations of prisoners upon admission to Bilibid Prison, Manila, P. I., 233.
 lesions encountered in one thousand consecutive autopsies in Manila, 453.
 parasitism, particularly entamoebiasis, in patients of the Philippine General Hospital, Manila, P. I., 81.
 Ipecac, treatment of entamoebiasis with, 93.
 Isolation of microorganisms by the pipette method, 307.

J

Jackson, C. M., *see* Reviews (book).
 JACKSON, THOMAS W., Sanitary survey in Mindoro. 4. The internal sanitary problem, 149.
 Jellyfish, another dangerous, in Philippine waters, 291.
 JOHNSTON, JOHN A., A contribution to the bacteriology of leprosy. Preliminary note, 227; review of MacNeal's Pathogenic Micro-organisms. A Text-book of Microbiology for Physicians and Students, 303; review of Jordan's A Text-book of General Bacteriology, 461; review of Stitt's The Diagnosis and Treatment of Tropical Diseases, 522.
 Jordan, Edwin O., *see* Reviews (book).

K

Kidney-worm infestation of swine in the Philippine Islands with special reference to the pathological changes, 269.

L

Laboratory apparatus, some simple, 297.
 used in the pipette method, 307.
 Lamblia, 173.
 Lard worm of pigs, 269.
 Lee, Arthur Bolles, *see* Reviews (book).
 Leishmania, 167, 169.
 Leprosy, a contribution to the bacteriology of, 227.
 data on, in the Philippine Islands, 204.
 Lesions, noninfectious or unclassified inflammatory, of intestines, 453, 458.
 Lewis, Frederick T., *see* Reviews (book).
 LIGHT, S. F., Another dangerous jellyfish in Philippine waters, 291.
 Lohonema mayeri Light, 293, 294.
 smithii Mayer, 293, 294, 295.

M

MacNeal, Ward J., *see* Reviews (book).
 Malaria, experiments on the transmission of, 381.
 in the Philippine General Hospital, Manila, P. I., during the fiscal year 1913, 441.
 in the Philippine Islands, 459.
 sanitary survey of the San Jose estate, Mindoro, with special reference to, 137.
 Malarial fever in the Philippine Islands, data on, 203.
 Mangifera indica L., 509.
 Linnæus, the lymphagocic action of, 503.
 Mango, Mangifera indica Linnæus, the lymphagocic action of, 503.
 rash, observations on, 509.
 Manson, Patrick, *see* Reviews (book).
 Medical geography of the Philippines, 199.
 Metastrongylus, 276.
 Microfilaria bancrofti, 202.
 Microorganisms, germicidal power of glycerin on, 465.
 the pipette method in the isolation of, 307.
 Milk poisoning due to a type of Staphylococcus albus in the udder of a healthy cow, 515.
 Monad, 81, 83.
 Monomorium latinode Mayr as a possible carrier of Asiatic cholera, 4.
 Morphology of the adults of the filaria found in the Philippine Islands, 483.
 Mosquitoes, collecting larvæ of, 392.
 dissection of, 398.
 infecting, 397.
 rearing, 394.
 MUSGRAVE, W. E., Sanitary survey in Mindoro. 1. Introduction, 133; 3. The general and external sanitary problem, 143.
 MUSGRAVE, W. E., and SISON, A. G., Bacillary dysentery: The most prevalent form in Manila and its treatment, 241.

- MUSGRAVE, W. E., VAZQUEZ A., GUTIERREZ, B., and COX, SETH L., Sanitary survey in Mindoro. 6. The disease index. (B) Clinical examinations, 173.
- MUSGRAVE, W. E., et al., Sanitary survey of the San Jose Estate and adjacent properties on Mindoro Island, Philippine Islands, with special reference to the epidemiology of malaria, 137.
- Myzomyia christophersi*, 439.
funesta Giles, 384.
listoni, 439.
ludlowii Theobald, 385.
mangyana Banks, 384.
rossii Theobald, 164, 385.
thorntonii Ludlow, 384.
- Myzorhynchus barbirostris* Theobald, 389.
barbirostris van de Wulp, 384.
peditaeniatus Leicester, 389.
pseudobarbirostris Ludlow, 384.
sinensis Theobald, 389.
sinensis Wiedemann, 384.
vanus Walker, 384.
- N
- Neosalvarian, treatment of entamoebiasis with, 93.
- Nephritis, chronic, 459.
- Nerve degeneration in fowls fed on unhusked rice (palay), 119.
- Nitella, 356.
- Nyssomyzomyia ludlowii* James and Liston, 385.
rossii James and Liston, 385.
- Nyssorhynchus fuliginosus* Giles, 384.
maculatus Theobald, 390.
philippinensis Ludlow, 384.
pseudowillmori Theobald, 390.
willmori Leicester nec James, 390.
- O
- Opisthorchis* (*Clonorchis*), 240.
- Oxyuris, 81, 83, 173, 235, 446.
- P
- Palay (unhusked rice), nerve degeneration in fowls fed on, 119.
- Paramecium, 356.
- Parasitism, intestinal, particularly entamoebiasis, in patients of the Philippine General Hospital, Manila, P. I., 81.
- Pelvimetry and cephalometry among Filipinas, 493.
- Perforation of gall bladder, 459.
- Periplaneta americana* Linnæus as a carrier of Asiatic cholera, 1.
- Physiological action of the proteoses, 499.
- Pipette method in the isolation of single microorganisms and in the inoculation of substances into living cells, 307.
- Pittenger, Paul S., *see* Reviews (book).
- Plague among rats and other animals, 9, 10.
bacillus, 466.
 in the Philippine Islands, 5, 19.
- Plague sanitary measures, 14.
 transmission by fleas, 14.
- Plasmodium malariae*, 168, 433.
præcox (*falciparum*), 168, 396, 432, 433.
vivax, 168, 432.
- Pneumonia, lobar, 459.
- Poisoning, milk, due to a type of *Staphylococcus albus*, 515.
- Polyneuritis in fowls, 119.
- Pottenger, Francis Marion, *see* Reviews (book).
- Proteoses, a note on the physiological action of the, 499.
- Pseudomyzomyia indefinata* Ludlow, 384.
ludlowii Theobald, 334.
rossii Giles, 384.
rossii Theobald, 385.
- Pulex cheopis*, in relation to plague, 14.
- Pyretophorus freeræ* Banks, 384.
minus Theobald, 384.
philippinensis Ludlow, 384.
pitchfordii Giles, 384.
- R
- Rats in human plague outbreak, 7, 9.
- Reed, Charles A. L., *see* Reviews (book).
- REVIEWS (BOOK) :
- Carus, Paul, *The Mechanistic Principle and the Non-mechanical. An Inquiry into Fundamentals with Extracts from Representatives of Either Side*, 380.
- Councilman, W. T., *Disease and Its Causes*, 462.
- De la Mettrie, Julien Offray, *Man a Machine*, 804.
- Dorland, W. A. Newman, *The American Illustrated Medical Dictionary*, 304.
- Henson, Graham E., *Malaria Etiology, Pathology, Diagnosis, Prophylaxis, and Treatment*, 463.
- Hering, Ewald, *Memory Lectures on the Specific Energies of the Nervous System*, 380.
- Howell, William H., *A Text-book of Physiology for Medical Students and Physicians*, 461.
- Jackson, C. M., *Morris's Human Anatomy, a Complete Systematic Treatise by English and American Authors*, 521.
- Jordan, Edwin O., *A Text-book of General Bacteriology*, 461.
- Lee, Arthur Bolles, *The Microtomists' Vade-mecum*, 461.
- Lewis, Dr. Frederick T., *A Text-book of Histology Arranged upon an Embryological Basis*, 462.
- MacNeal, Ward J., *Pathogenic Microorganisms. A Text-book of Microbiology for Physicians and Students of Medicine*, 303.
- Manson, Patrick, *Tropical Diseases, a Manual of the Diseases of Warm Climates*, 463.

REVIEWS (BOOK)—Continued.

- Pittenger, Paul S., Biochemic Drug Assay Methods, with Special Reference to the Pharmaco-dynamic Standardization of Drugs, 379.
- Pottenger, Francis Marion, Muscle Spasm and Degeneration in Intrathoracic Inflammations, 464.
- Reed, Charles A. L., Marriage and Genetics, Laws of Human Breeding and Applied Eugenics, 463.
- Robinson, Victor, An Essay on Hasheesh, including Observations and Experiments, 305.
- Ross, H. C., Cropper, J. W., Ross, E. H., Further Researches into Induced Cell-reproduction and Cancer, 464.
- Satterthwaite, Thomas E., Cardio-vascular Diseases. Recent Advances in their Anatomy, Physiology, Pathology, Diagnosis and Treatment, 305.
- Stitt, E. R., Practical Bacteriology, Blood Work, and Animal Parasitology, including Bacteriological Keys, Zoölogical Tables and Explanatory Clinical Notes, 304.
- Stitt, E. R., The Diagnosis and Treatment of Tropical Diseases, 522.
- Tyson, James and Fussell, Howard, The Practice of Medicine. A Text-book for Practitioners and Students with Special Reference to Diagnosis and Treatment, 303.
- Vedder, Edward B., Beriberi, 380.
- Rice (palay), unhusked, nerve degeneration in fowls fed on, 119.
- Rinderpest, an atypical case of, in a carabao, 45.
 .a preliminary report of experiments on the cultivation of the virus of, in vitro, 39.
 experiments upon the transmission of, 49.
 virus of, experiments on the cultivation of, as described by Baldrey, 259.
- Robinson, Victor, *see* Reviews (book).
- Ross, E. H., *see* Ross, H. C.
- Ross, H. C., *see* Reviews (book).
- RUEDIGER, E. H., The germicidal power of glycerin on various microorganisms under various conditions, 465.
- RUTH, E. S., review of Jackson's Morris's Human Anatomy, 522.
- S
- Sanitary survey of the San Jose estate and adjacent properties on Mindoro Island, Philippine Islands, with special reference to the epidemiology of malaria, 137.
- San Jose Estate, sanitary survey of the, with special reference to malaria, 137.
- Sarcina, 222.
- Satterthwaite, Thomas E., *see* Reviews (book).
- Schistosoma japonicum, 236.
- SCHÖBL, OTTO, The etiology of trichomycosis palmellina in the Philippine Islands, 219; The vitality of the cholera vibrio in Manila waters, 479.
- Sciatic nerve, degeneration of, in polyneuritis, 122.
- Sclerostoma equinum, 283.
 pinguicola Verrill, 269.
- Scyphomedusæ, 294.
- Seatworm, 235.
- Sepsis, 459.
- Serum from animals that have been recently immunized, simultaneous method of inoculating cattle and carabaos with, 125.
- SISON, A. G., review of Tyson and Fussell's The Practice of Medicine. A Text-book for Practitioners and Students with Special Reference to Diagnosis and Treatment, 303; *see also* MUSGRAVE, W. E., 241.
- Smallpox in the Philippine Islands, data on, 204.
- Spirillum of cholera, 466 et seq.
- Spirogyra, 344, 356.
- Staining, technique for, 307.
- STANLEY, COURT R., *see* WILLETS, DAVID G., 93.
- Staphylococcus albus, 465 et seq.
 albus, milk poisoning due to a type of, 515.
 aureus, 222, 466 et seq.
- Stegomyia, 356.
 calopus, 436.
 pseudoscutellaris, 489.
- Stephanurus dentatus Diesing, 269 et seq.
- Stethomyia pallida Ludlow, 384.
- Stitt, E. R., *see* Reviews (book).
- Streptothrix, 227.
- Strongyloides, 81, 83, 173, 236 et seq., 446 et seq.
 stercoralis, 173.
- Strongylus armatus, 276, 283.
- Swine, kidney-worm infestation of, 269.
- T
- Tænia, 236 et seq.
- Thermoesthesiometer, 297.
- Timing system, a simple, 298.
- Transmission of rinderpest, 49.
- Trauma, 459.
- Trichomonas, 173.
- Trichomycosis palmellina, etiology of, in the Philippine Islands, 219.
- Trichuris, 81, 83, 173, 233 et seq., 446 et seq.
- Trypanosoma rhodesiense, 382.
- Tuberculosis, data on, in the Philippine Islands, 206.
 intestinal, 453 et seq.
- Typhoid bacillus, 465 et seq.
 fever in the Philippine Islands, 206, 367, 453, 455.
- Tyson, James, and Fussell, Howard, *see* Reviews (book).

- U
- Uræmia, 459.
- V
- Vaucheria, 356.
 VAZQUEZ, A., *see* MUSGRAVE, W. E., 173.
 Vedder, Edward B., *see* Reviews (book).
 Vibrio, vitality of the cholera, in Manila waters, 479.
 Vibrios, cockroaches and ants as carriers of the, of Asiatic cholera, 1.
 Virus of rinderpest, a preliminary report of experiments on the cultivation of the, in vitro, 39.
 experiments on the cultivation of, as described by Baldrey, 259.
- W
- WALKER, ERNEST LINWOOD, The morphology of the adults of the filaria found in the Philippine Islands, 483.
 WALKER, ERNEST LINWOOD, and BARBER, MARSHALL A., Malaria in the Philippine Islands, I. Experiments on the transmission of malaria with Anopheles (*Myzomyia*) febrifer sp. nov., Anopheles (*Pseudomyzomyia*) rossii, Anopheles (*Myzorhynchus*) barbirostris, Anopheles (*Myzorhynchus*) sinensis, and Anopheles (*Nyssorhynchus*) maculatus, 381.
 WALKER, E. L., and COX, S. L., Sanitary survey of Mindoro. 7. A comparison of the spleen index with the microscopic examination of the blood for malarial parasites in 1,003 persons, 180.
- WALKER, E. L., GUZMAN, A. M., and CONCEPCION, I., Sanitary survey in Mindoro. 6. The disease index. (A) Laboratory examinations, 167.
 WARD, ARCHIBALD R., and WOOD, FREDERICK WILLAN, Simultaneous method of inoculating cattle and carabaos with serum from animals that have been recently immunized, 125.
 WARD, ARCHIBALD R., WOOD, FREDERICK WILLAN, and BOYNTON, WILLIAM HUTCHINS, Experiments upon the transmission of rinderpest, 49.
 Waters, vitality of the cholera vibrio in Manila, 479.
 Widal reactions among healthy adult Filipinos, 253.
 WILLETS, DAVID G., Intestinal parasitism, particularly entamæbiasis, in patients of the Philippine General Hospital, Manila, P. I., 81; Preliminary report on the treatment of entamæbiasis with ipecac, emetine, and neosalvarsan at the Philippine General Hospital, Manila, P. I., 93; Intestinal helminthiasis in the Philippine Islands as indicated by examinations of prisoners upon admission to Bilibid Prison, Manila, P. I., 233; Widal reactions among healthy adult Filipinos, 253; review of Stitt's Practical Bacteriology, Blood Work, and Animal Parasitology, including Bacteriological Keys, Zoological Tables, and Explanatory Clinical Notes, 304; Malaria in the Philippine General Hospital, Manila, P. I., during the fiscal year 1913, 441.
 WOOD, FREDERICK WILLAN, *see* WARD, ARCHIBALD R., 49, 125.

**PUBLICATIONS FOR SALE BY THE BUREAU OF SCIENCE,
MANILA, PHILIPPINE ISLANDS—Continued**

BOTANY

A FLORA OF MANILA

By **ELMER D. MERRILL**

Order No. 419. Paper, 490 pages, \$2.50, postpaid.

Practically a complete flora of the cultivated areas in the Philippines. Descriptions, with keys, of over 1,000 species, 590 genera, and 136 families, with native names, glossary of technical terms, etc.

THE COCONUT PALM IN THE PHILIPPINE ISLANDS

Order No. 37. Paper, 149 pages, 30 plates, \$1, postpaid.

The reprint contains the following articles: On the Water Relations of the Coconut Palm (*Cocos nucifera*), The Coconut and its Relation to Coconut Oil, The Keeping Qualities of Coconut Oil and the Causes of its Rancidity, and The Principal Insects Attacking the Coconut Palm.

INDO-MALAYAN WOODS

By **FRED W. FOXWORTHY**

Order No. 411. Paper, 182 pages, 9 plates, \$0.50, postpaid.

In Indo-Malayan Woods, Doctor Foxworthy has brought together a large amount of accurate information concerning trees yielding woods of economic value.

ZOOLOGY

A LIST OF THE MAMMALS OF THE PHILIPPINE ISLANDS, EXCLUSIVE OF THE CETACEA

By **NED HOLLISTER**

Order No. 418. Paper, 64 pages, \$0.50, postpaid.

This is the only recent attempt to enumerate the mammals of the Philippine Islands. The distribution of each species is given, and the original descriptions are cited.

ZOOLOGY—Continued

A MANUAL OF PHILIPPINE BIRDS

By **RICHARD C. MCGREGOR**

Order No. 103. Paper, 2 parts, 769 pages, \$4, postpaid.

A Manual of Philippine Birds contains in compact form descriptions of all the known species of Philippine birds. The usual keys and diagnoses of orders, families, and genera help the novice in identification.

A CHECK-LIST OF PHILIPPINE FISHES

By **DAVID STARR JORDAN** and **ROBERT EARL RICHARDSON**

Order No. 102. Paper, 78 pages, \$0.75, postpaid.

This list will be found a convenient guide to the synonymy of Philippine ichthyology. The nomenclature is thoroughly revised, and the distribution of each species within the Philippine Islands is given.

MEDICINE

REPORT OF THE INTERNATIONAL PLAGUE CONFERENCE

Held at Mukden, April, 1911, under the auspices of the Chinese Government.

Edited by **ERICH MARTINI**, **G. F. PETRIE**, **ARTHUR STANLEY**, and **RICHARD P. STRONG**

483 pages, 18 plates (2 colored, 4 halftones, 12 charts and maps)

Order No. 416. Paper, \$2.50; cloth, \$3.50; postpaid.

The proceedings of this International Conference and information gained therefrom, together with the results of certain bacteriological investigations, constitute the present report.

The Bureau of Science of the Government of the Philippine Islands has been appointed sole agent for the distribution of the printed proceedings of the International Plague Conference.

PRICES ARE IN UNITED STATES CURRENCY

Orders for these publications may be sent to the **BUSINESS MANAGER, PHILIPPINE JOURNAL OF SCIENCE, BUREAU OF SCIENCE, MANILA, P. I.**, or to any of the agents listed below. Please give order number.

The Macmillan Company, 64-66 Fifth Avenue, New York, U. S. A.
Wm. Wesley & Son, 28 Essex Street, Strand, London, W. C., England.
Martinus Nijhoff, Lange Voorhout 9, The Hague, Holland.
Mayer & Müller, Prinz Louis Ferdinandstrasse 2, Berlin, N. W., Germany.
Kelly & Walsh, Ltd., 32 Raffles Place, Singapore, Straits Settlements.
A. M. & J. Ferguson, 19 Ballie Street, Colombo, Ceylon.
Thacker, Spink & Co., P. O. Box 54, Calcutta, India.

CONTENTS

	Page
RUEDIGER, E. H. The Germicidal Power of Glycerin on Various Microorganisms under Various Conditions.....	465
SCHÖBL, OTTO. The Vitality of the Cholera Vibrio in Manila Waters	479
WALKER, ERNEST LINWOOD. The Morphology of the Adults of the Filaria Found in the Philippine Islands.....	483
ACOSTA-SISON, HONORIA. Pelvimetry and Cephalometry among Filipinas	493
GIBSON, R. B. A Note on the Physiological Action of the Proteoses	499
GIBSON, R. B. and CONCEPCIÓN, ISABELO. The Lymphogogic Action of the Philippine Mango, <i>Mangifera indica</i> Linnæus	503
CONCEPCIÓN, ISABELO. Observations on Mango Rash.....	509
BARBER, M. A. Milk Poisoning due to a Type of <i>Staphylococcus albus</i> Occurring in the Udder of a Healthy Cow.....	515
REVIEWS	521
Index, Title-page, and Contents.....	523

	U. S. currency
The "Philippine Journal of Science" is issued as follows:	
Section A. Chemical and Geological Sciences and the Industries..	\$2.00
Section B. Tropical Medicine	3.00
Section C. Botany	2.00
Section D. General Biology, Ethnology, and Anthropology (Section D began with Volume V)	2.00
Entire Journal, Volume II, III, IV, or V	5.00
Entire Journal, beginning with Volume VI	7.00
Single numbers of Volume I75
Single numbers (except of Volume I)50
Volume I, 1906 (not divided into sections) and supplement, sold only with a complete file of section A, B, or C.....	10.00
Supplement to Volume I (Botany)	3.50
Volume I (without supplement), sold only with a complete file of section A, B, or C.....	6.50

Each section is separately paged and indexed.

Publications sent in exchange for the Philippine Journal of Science should be addressed: Library, Bureau of Science, Manila, P. I.

Subscriptions may be sent to the BUSINESS MANAGER, Philippine Journal of Science, Bureau of Science, Manila, P. I., or to any of the agents listed below:

AGENTS

The Macmillan Company, 64-66 Fifth Avenue, New York City, U. S. A.
 Wm. Wesley & Son, 28 Essex Street, Strand, London, W. C., England.
 Martinus Nijhoff, Lange Voorhout 9, The Hague, Holland.
 Mayer & Müller, Prinz Louis Ferdinandstrasse 2, Berlin, N. W., Germany.
 Kelly & Walsh, Limited, 32 Raffles Place, Singapore, Straits Settlements.
 A. M. & J. Ferguson, 19 Ballie Street, Colombo, Ceylon.
 Thacker, Spink & Co., P. O. Box 54, Calcutta, India.

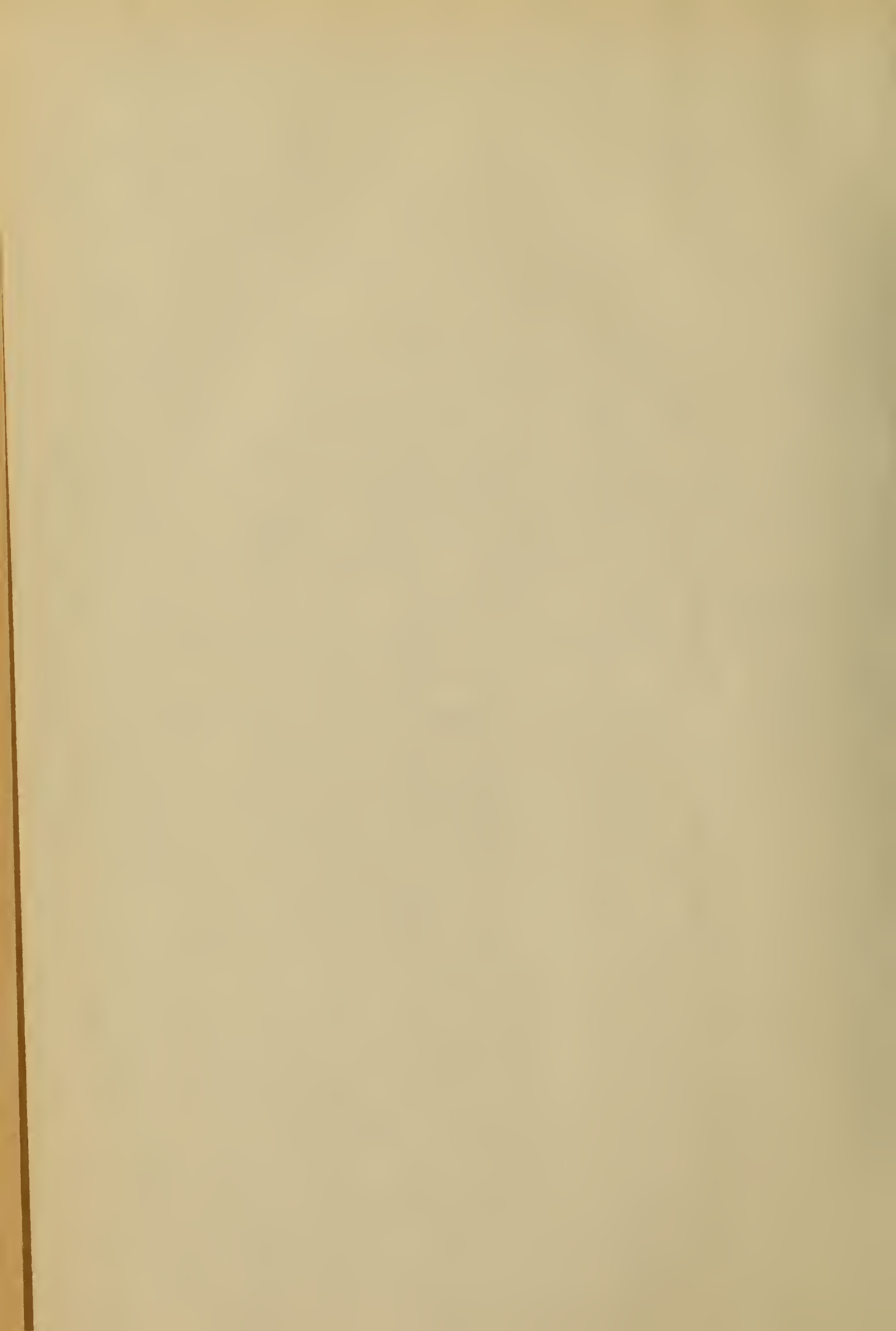



SMITHSONIAN INSTITUTION LIBRARIES

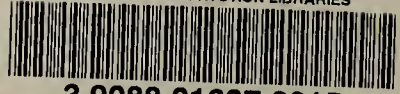

3 9088 01307 6815